

PHE 1130TGRID

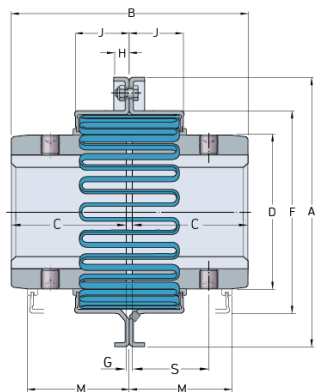

Size	1130
Nominal torque (Nm)	19900
Max speed (r/min)	2400
Min. bore (mm)	66
Max. bore (mm)	165
Weight (kg)	4.6