

PHE 1070TGHCOVER

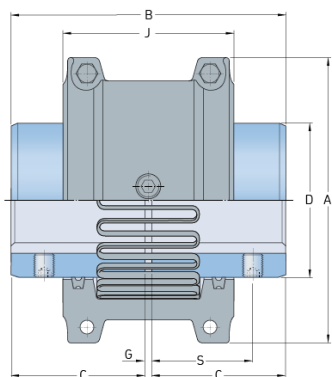

Size	1070
Nominal torque (Nm)	994
Max speed (r/min)	4125
Min. bore (mm)	19
Max. bore (mm)	65
Weight (kg)	1.45