

PHE 1040TGRID

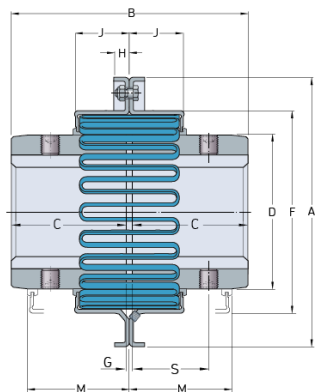

Size	1040
Nominal torque (Nm)	249
Max speed (r/min)	6000
Min. bore (mm)	12
Max. bore (mm)	44
Weight (kg)	0.1