

subject to technical alterations

type:	E200
range:	100 - 150 mm
range of indication:	99,5 - 150,5 mm
digital step:	0,02 mm
scale interval:	
measuring force:	0,8 - 1,7 N
weight:	530 g

acceptable deviations VDI/VDE/DGQ 2618 Bl. 12.1/13.1)	
max. permissible errors "G":	0,08 mm
repeatability "r":	0,06 mm
reference temperature:	20° C
operation temperature:	10° C - 30° C
storage temperature:	-10° C - 50° C

scale:	1:2
drawing-nr.:	DAB-C4150_KR_en
date of issue:	10.04.2013
name:	Lange
revision status:	
revision date:	

interface as accessories available:

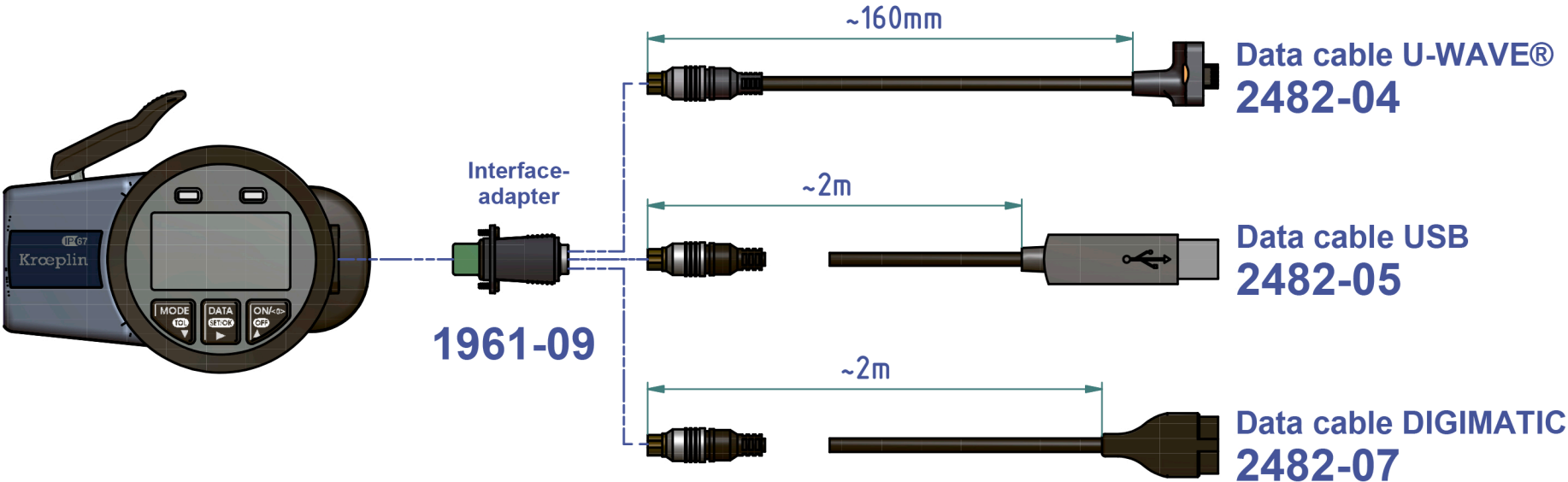

subject to technical alterations

drawing-nr.:	DAB-C4150_KR_en
date of issue:	10.04.2013
name:	Lange
revision status:	
revision date:	