

**FRIZIONI
ELETTROMAGNETICHE
MONODISCO
Serie SCM - 2**

**SINGLE PLATE
ELECTROMAGNETIC
CLUTCHES
Model SCM - 2**

PRESTAZIONI (24 VCC) • PERFORMANCES (24VDC)

tipo size	coppia torque (Nm)	potenza power (W)	giri/min rpm	tempo inserzione engagement time (ms)	tempo disinserzione disengagement time (ms)	peso weight (kg)
SCM 039-2	0,6	6	1.500	15	3	0,08
SCM 045-2	0,9	6	1.500	20	4	0,12
SCM 054-2	1,8	8	1.500	25	5	0,21
SCM 065-2	3,6	10	1.500	35	6	0,35
SCM 080-2	7,5	15	8.000	35	10	0,83
SCM 100-2	15	20	6.000	40	20	1,28
SCM 125-2	30	28	5.000	60	30	2,4
SCM 150-2	60	35	4.000	80	45	4,15
SCM 190-2	120	50	3.000	100	60	7,3
SCM 230-2	240	68	3.000	115	70	14,5
SCM 290-2	480	85	2.000	130	80	22,9

DIMENSIONI (mm) • DIMENSIONS (mm)

tipo - size	A	B	C max	D	E	G	H	K	I	L	M	N max	P	R	S
SCM 039-2	8	22,5	8	16	31	17,2	1,5	18	21	3,5	13	8	26,35	31	0,1
SCM 045-2	10	26	8	18	34	27,5	1,5	20	23	3,5	15	8	31,55	34	0,15
SCM 054-2	12	31	10	25	43	32,5	1,5	23	26	3,5	17	10	37,4	43	0,15
SCM 065-2	12	34	15	32	54	35,5	1,5	28	31	3,5	24	15	38,7	54	0,2
SCM 080-2	15	40	20	64	63	26	1,5	36	41	4,1	27	20	59	68	0,2
SCM 100-2	20	43,5	25	68	80	28	1,5	45	50	4,1	32	22	68	85,5	0,2
SCM 125-2	25	49	30	85	100	32,5	2,5	56	60	4,1	42	30	80	107	0,2
SCM 150-2	30	55	40	100	125	36	2,5	68,5	72,5	4,1	49	35	92	134,3	0,3
SCM 190-2	38	61,5	50	127	160	41,7	3,5	87,5	93,5	8,1	65	45	108,5	170	0,3
SCM 230-2	48	74	60	152,4	200	48,1	3,5	107,5	113,5	8,1	83	60	133,5	214,3	0,5
SCM 290-2	55	81	80	152,4	250	55,2	3,5	135	141	8,1	105	70	149	266,5	0,5

DENOMINAZIONE ELEMENTI • PARTS NAME

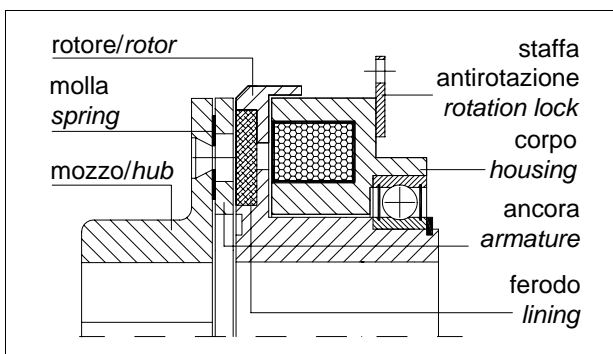

ESEMPIO DI MONTAGGIO • MOUNTING EXAMPLE

