

subject to technical alterations

type: E200
range: 0 - 50 mm
range of indication: 0 - 50,5 mm
digital step: 0,02 mm
scale interval:
measuring force: 0,8 - 1,7 N
weight: 500 g

acceptable deviations
 VDI/VDE/DGQ 2618 Bl. 12.1/13.1)
max. permissible errors "G": 0,08 mm
repeatability "r": 0,06 mm
reference temperature: 20° C
operation temperature: 10° C - 30° C
storage temperature: -10° C - 50° C

scale: 1:2
drawing-nr.: DAB-C450T_KR_en
date of issue: 10.04.2013
name: Lange
revision status:
revision date:

interface as accessories available:

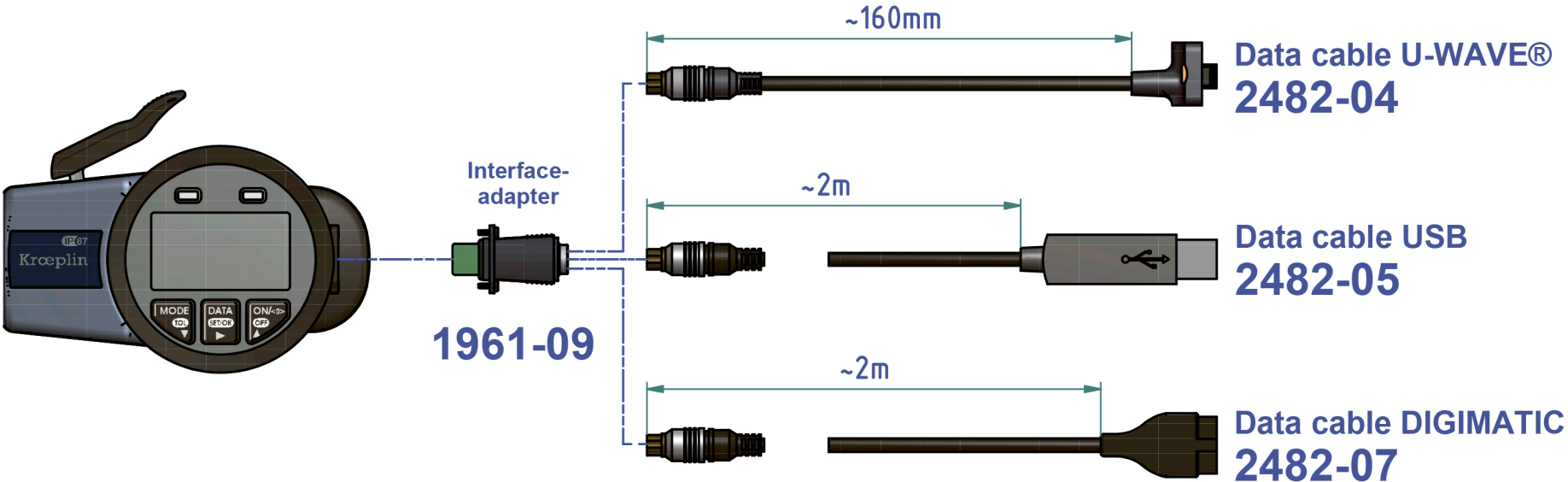

subject to technical alterations

drawing-nr.:	DAB-C450T_KR_en
date of issue:	10.04.2013
name:	Lange
revision status:	
revision date:	