

subject to technical alterations

**type:** G  
**range:** 30 - 50 mm  
**range of indication:** 29,5 - 50,5 mm  
**digital step:** 0,01 mm  
**scale interval:** -  
**measuring force:** 1,1 - 1,6 N  
**weight:** 255 g

acceptable deviations  
 VDI/VDE/DGQ 2618 Bl. 12.1/13.1)  
**max. permissible errors "G":** 0,03 mm  
**repeatability "r":** 0,01 mm  
**reference temperature:** 20° C  
**operation temperature:** 10° C - 30° C  
**storage temperature:** -10° C - 50° C

**scale:** 1:1  
**drawing-nr.:** DAB-G2G30\_KR\_e  
**date of issue:** 07.01.09  
**name:** M. Balzer  
**revision status:**  
**revision date:**

interface as accessories available:

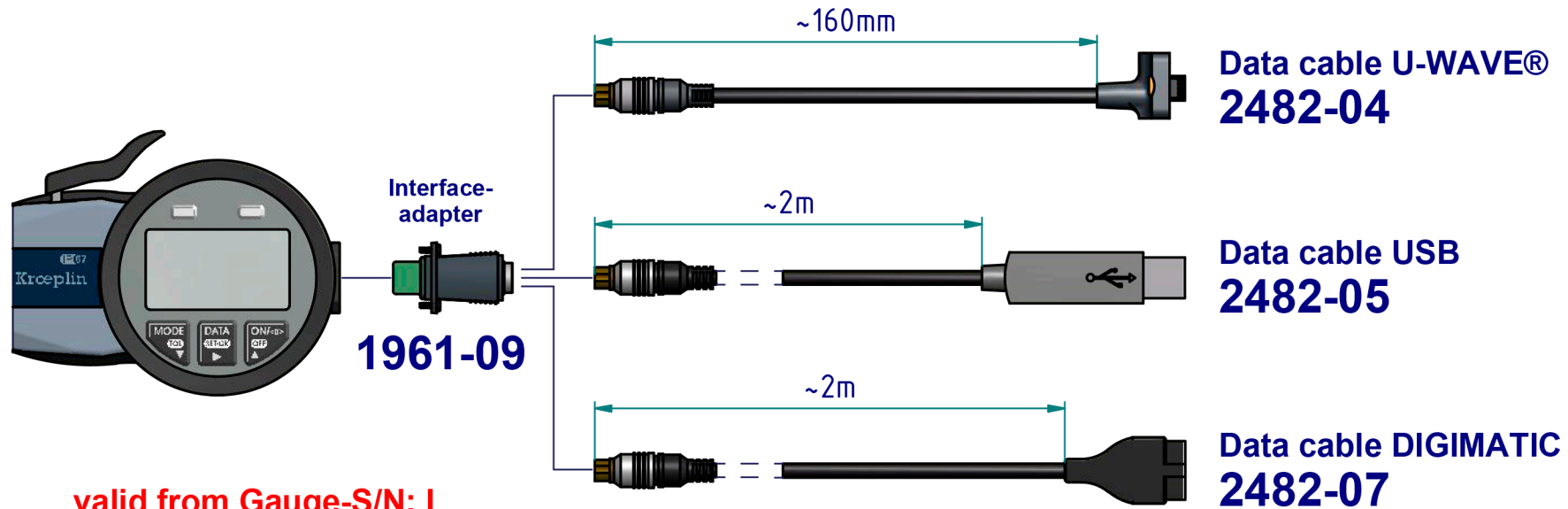

**valid from Gauge-S/N: I**  
**Always specify serial number**  
**when ordering Interfaces or accessories!**

subject to technical alterations

drawing-nr.:	DAB-G2G30_KR_e
date of issue:	07.01.09
name:	M. Balzer
revision status:	2043
revision date:	24.02.12