

# PHE 1140TGVCOVER

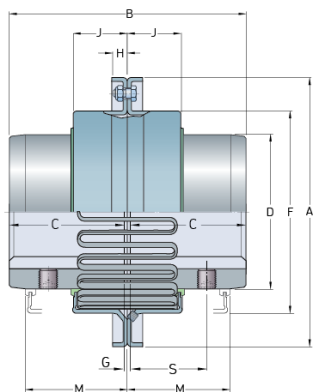

Size	1140
Nominal torque (Nm)	28600
Max speed (r/min)	2200
Min. bore (mm)	66
Max. bore (mm)	184
Weight (kg)	10.2