

TECHNOBEARING

Measuring instruments and systems



precision measuring instruments
mechanical - optical - electronical
3D CNC coordinate measuring machines

2019/2020

GENERAL
CATALOG

Measuring instruments and systems

TECHNOBEARING

Technobearing OOO
Mitrofanievskoye shosse 10
198095 Saint-Petersburg, Russia
www.technobearing.ru

Table of contents

category	page
1 Calipers / Depth calipers and micrometers	4–40
2 Micrometers / Micrometer heads	41–78
3 Internal micrometers / Internal & external measuring instruments	79–113
4 Dial indicators / Dial test indicators / Center instruments Edge finders / Probes / MF measuring fixture system	114–134
5 Stands / Bench centers / Surface plates	135–153
6 V-blocks / Vises / Angle plates / Cylindrical squares Squares / Parallels / Straight edges	154–186
7 Protractors / Clinometers / Spirit levels	187–205
8 Gauge blocks / Measuring balls / Optical flats and plan parallel optical flats / Feeler gauges / Roughness specimens	206–223
9 Gauges / Pin gauges / Thread and tolerance tables	224–239
10 Magnifiers / Microscopes / Glass rulers Stereo microscopes / Endoscopes	240–265
11 Graduated rulers / Scale units / Circumference tapes Precision tapes / Distance meters	266–276
12 Scribing tools / Compasses / Center squares	277–284
13 Height and scribing gauges / Height gauges	285–291
14 Hardness testers / (Coating) thickness gauges / (Infrared) thermometers Tachometers / Dynamometers / Inspection instruments	292–312

Calipers / Depth calipers and micrometers

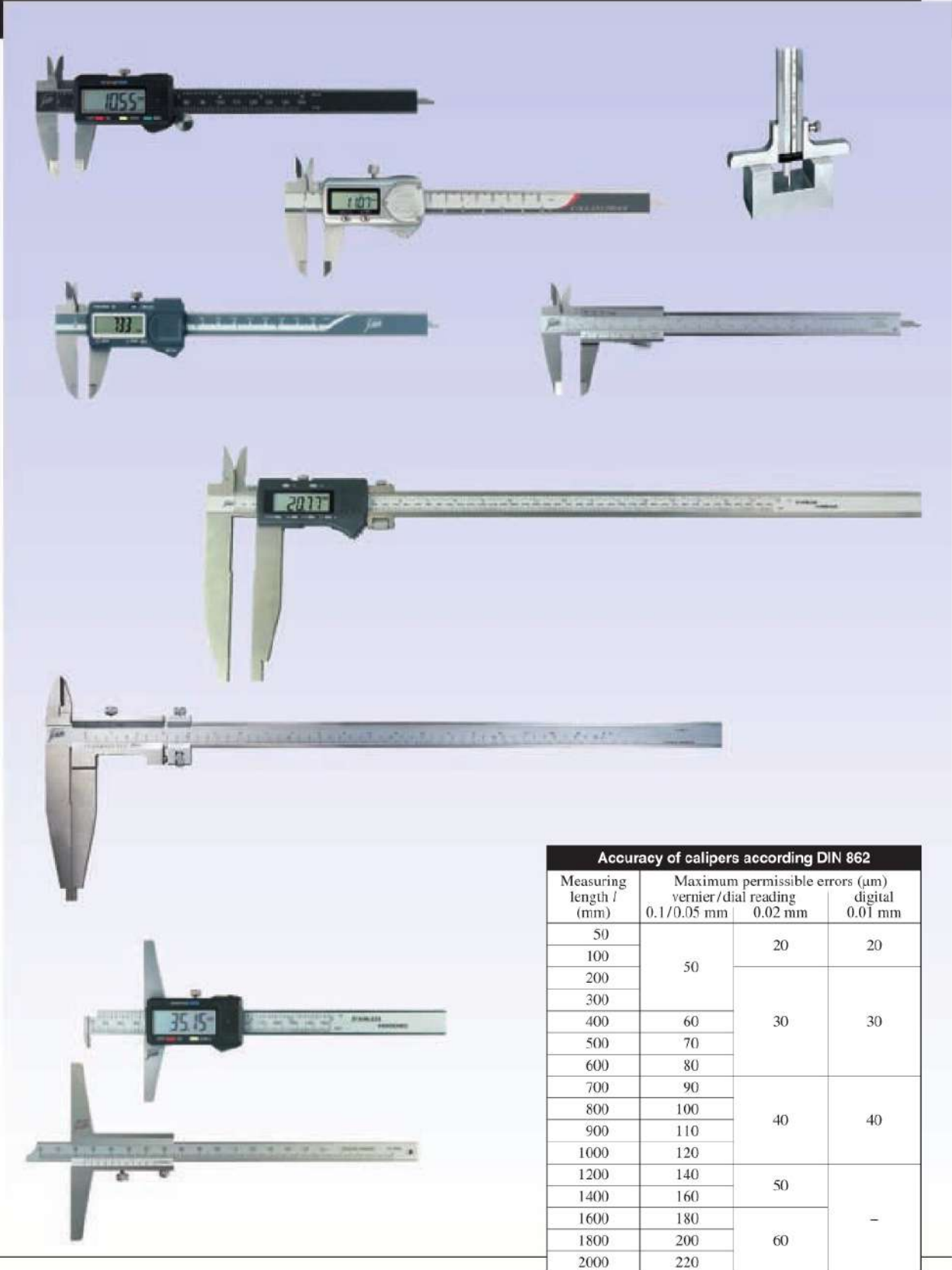

Measuring length <i>l</i> (mm)	Accuracy of calipers according DIN 862		
	Maximum permissible errors (µm) vernier / dial reading		digital
	0.1/0.05 mm	0.02 mm	0.01 mm
50	50	20	20
100			
200			
300			
400	60	30	30
500	70		
600	80		
700	90		
800	100	40	40
900	110		
1000	120		
1200	140		
1400	160	50	-
1600	180		
1800	200		
2000	220		

DOC-001 Technobearing 201 (REV2)

Absolute digital calipers

Calipers with an absolute measuring system for easy incremental and absolute conversion.

- Measuring range: 0-300 mm.
- Resolution: 0.01 mm.
- mm/inch conversion.
- ABS/INC switchable.
- On/off switch.
- Reset.
- Large LCD display.
- Thumb wheel/locking screw/flat depth rod.
- Power supply: 1 battery type V357.

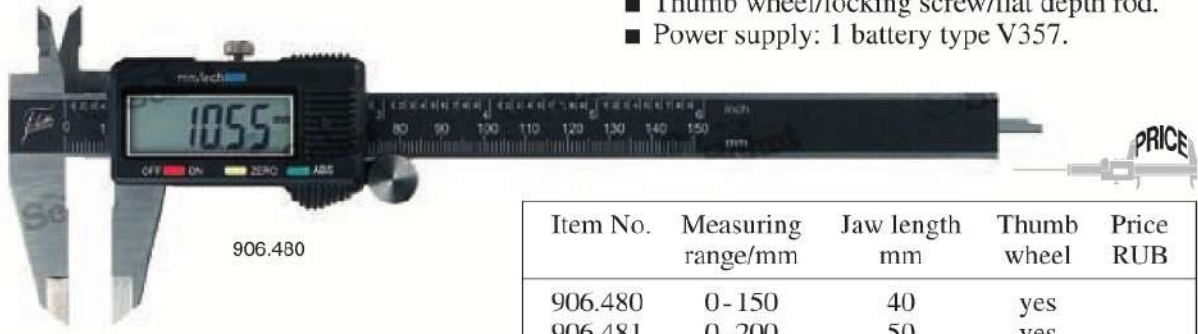

906.480

TECHNOBEARING

Item No.	Measuring range/mm	Jaw length mm	Thumb wheel	Price RUB
906.480	0-150	40	yes	
906.481	0-200	50	yes	
906.482	0-300	60	yes	
Option:				
836.535	Spare battery			

Digital calipers with excellent price-performance ratio

- Measuring range: 0-300 mm.
- Resolution: 0.01 mm.
- mm/inch conversion.
- On/off switch.
- Reset.
- Large LCD display (except 906.483/484).
- Thumb wheel (except 906.483/484).
- Locking screw/flat depth rod.
- Power supply: 1 battery type V357.

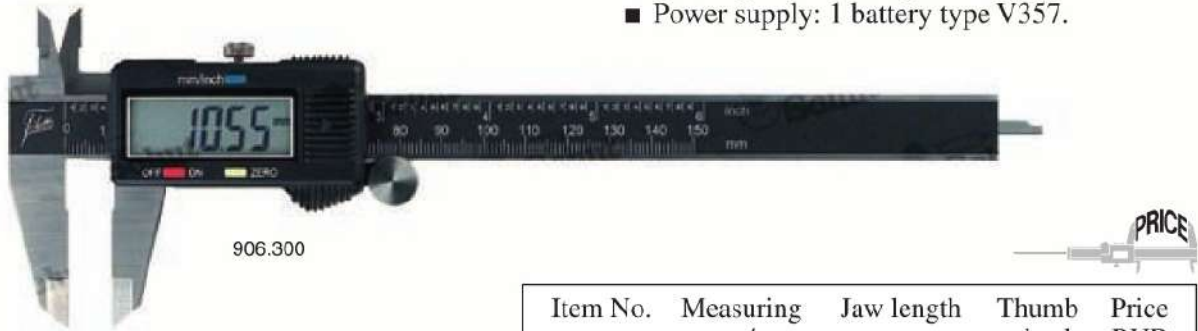

906.300



906.299

Item No.	Measuring range/mm	Jaw length mm	Thumb wheel	Price RUB
906.483	0-75	30	no	
906.484	0-100	30	no	
906.300	0-150	40	yes	
906.302	0-200	50	yes	
906.304	0-300	60	yes	
Left-handed model:				
906.299	0-150	40	yes	
Option:				
836.535	Spare battery			

002-202 Technobearing 201 (9623)

Absolute digital calipers

Calipers with an absolute measuring system for easy incremental and absolute conversion. The advantage of these calipers is the one-time setting of the absolute zero position until the battery has to be changed. This reduces the chance of measuring errors and enables you to use the calipers without zero setting.

- Measuring range: 0-300 mm.
- Resolution: 0.01 mm.
- mm/inch conversion.
- ABS/INC switchable.
- On/off switch.
- Automatic switch-off.
- Reset.
- Large LCD display.
- Thumb wheel/locking screw/flat depth rod.
- DIN 862.
- Delivery with an inspection report.
- Power supply: 1 battery type V357.



Item No.	Measuring range/mm	Jaw length mm	Price RUB
907.546	0-150	40	
907.547	0-200	50	
907.548	0-300	60	
Option:			
836.535	Spare battery		

Digital calipers

The advantage of these calipers is the one-time setting of the absolute zero position until the battery has to be changed. This reduces the chance of measuring errors and enables you to use the calipers without zero setting.

- Measuring range: 0-300 mm.
- Resolution: 0.01 mm.
- mm/inch conversion.
- On/off switch.
- Automatic switch-off.
- Reset.
- Large LCD display.
- Thumb wheel/locking screw/flat depth rod.
- DIN 862.
- Delivery with an inspection report.
- Power supply: 1 battery type V357.



Item No.	Measuring range/mm	Jaw length mm	Price RUB
907.537	0-150	40	
907.538	0-200	50	
907.539	0-300	60	
Option:			
836.535	Spare battery		

Digital calipers with hold function

Digital calipers with a function to hold the display value at any position.

- Measuring range: 0-300 mm.
- Resolution: 0.01 mm.
- mm/inch conversion.
- On/off switch.
- Reset.
- Hold function.
- Large LCD display.
- Thumb wheel/locking screw/flat depth rod.
- Power supply: 1 battery type V357.

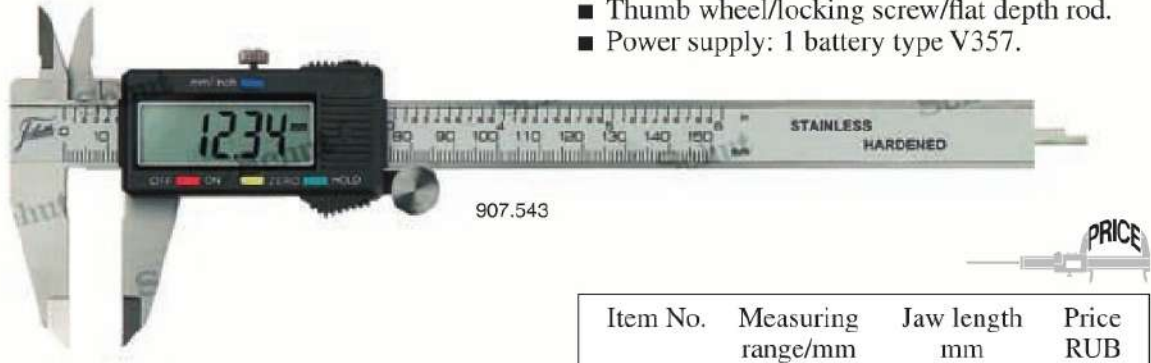

907.543

Item No.	Measuring range/mm	Jaw length mm	Price RUB
907.543	0-150	40	
907.544	0-200	50	
907.545	0-300	60	
Option:			
836.535	Spare battery		

Digital calipers with min/max function

By keeping the mode button pressed you can hold the minimum and maximum measuring values.

- Measuring range: 0-300 mm.
- Resolution: 0.01 mm.
- mm/inch conversion.
- On/off switch.
- Reset.
- Min/max function.
- Large LCD display.
- Thumb wheel/locking screw/flat depth rod.
- Power supply: 1 battery type V357.

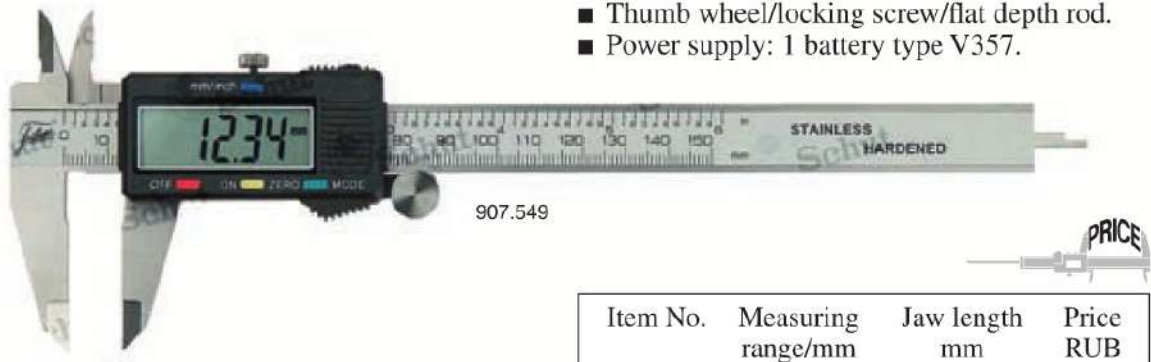

907.549

TECHNOBEARING

Item No.	Measuring range/mm	Jaw length mm	Price RUB
907.549	0-150	40	
907.550	0-200	50	
907.551	0-300	60	
Option:			
836.535	Spare battery		

Digital calipers 0.005 mm

Calipers with a higher resolution and a measuring range up to 300 mm.

- Measuring range: 0-300 mm.
- Resolution: **0.005 mm**.
- mm/inch conversion.
- ABS/INC switchable.
- On/off switch.
- Automatic switch-off.
- Reset.
- Thumb wheel/locking screw/flat depth rod.
- DIN 862.
- Power supply: 1 battery type CR2032.

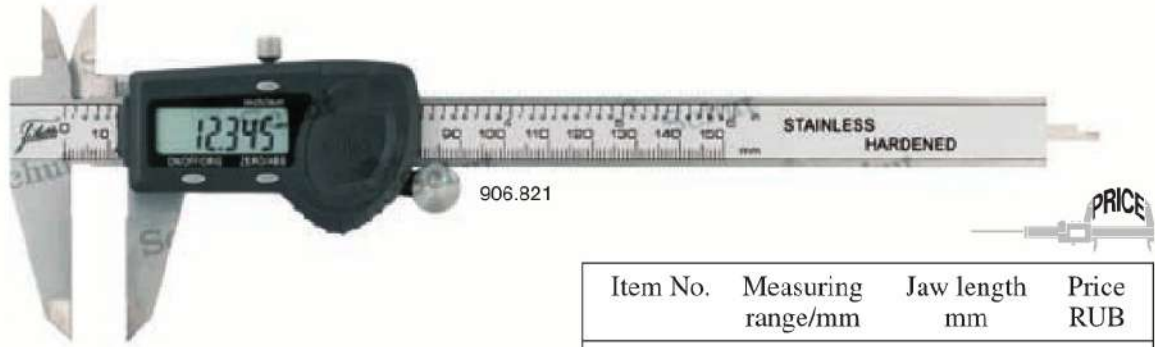

906.821

Item No.	Measuring range/mm	Jaw length mm	Price RUB
906.821	0-150	40	
906.822	0-200	50	
906.823	0-300	60	
Option:			
495.157	Spare battery		

Digital solar calipers

The solar power supply functions already with a low illumination level.

- Measuring range: 0-300 mm.
- Resolution: 0.01 mm.
- mm/inch conversion.
- Automatic switch-off.
- Reset.
- Thumb wheel/locking screw/flat depth rod.
- Back-up power supply (prevents shut-down in dark places): 1 battery type V389.

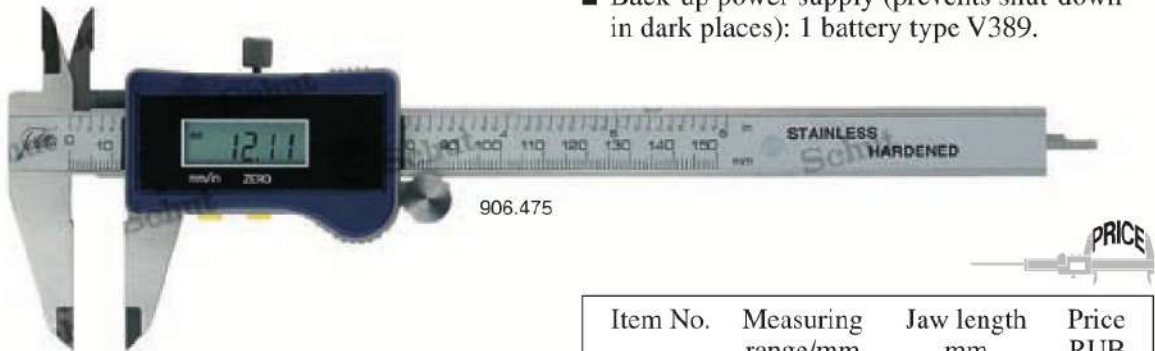

906.475

Item No.	Measuring range/mm	Jaw length mm	Price RUB
906.475	0-150	40	
906.492	0-200	50	
906.493	0-300	60	
Option:			
498.823	Spare battery		

TECHNOBEARING

002.317. Technobearing 201 (9623)

Digital calipers with glass ruler

Equipped with a glass ruler. Very easy displacement by non-contact movement.

- Measuring range: 0-300 mm.
- Resolution: 0.01 mm.
- mm/inch conversion.
- ABS/INC switchable (only 909.443/444/445).
- With data output.
- On/off switch.
- Automatic switch-off.
- Reset.
- Large LCD display.
- Thumb wheel/locking screw/flat depth rod.
- DIN 862.
- Delivery with an inspection report.
- Power supply: 1 battery type CR2025.

TECHNOBEARING

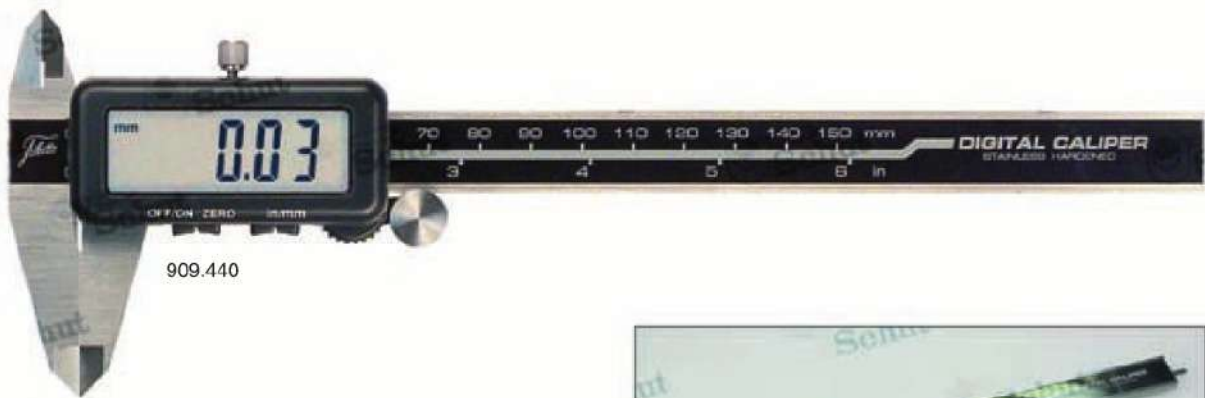

909.440



909.440



909.446

USB interface:

- For data transfer to PC (e.g. Excel, Word).
- Operating system: Windows and other.
- PC connection: USB.
- No software or driver to install.
- Foot switch (optional).

PRICE

Item No.	Measuring range/mm	Jaw length mm	Price RUB
909.440	0-150	40	
909.441	0-200	50	
909.442	0-300	60	
Absolute calipers:			
909.443	0-150	40	
909.444	0-200	50	
909.445	0-300	60	

Options:

- 495.214 Spare battery
- 909.446 USB interface
- 909.687 Footswitch for USB interface

Digital calipers with tolerance function

Digital calipers with function to set tolerance limits with Go/NoGo reading.

- Measuring range: 0-300 mm.
- Resolution: 0.01 mm.
- mm/inch conversion.
- With data output.
- Tolerance function.
- On/off switch.
- Automatic switch-off.
- Reset.
- Large LCD display.
- Thumb wheel/locking screw/flat depth rod.
- DIN 862.
- Delivery with an inspection report.
- Power supply: 1 battery type CR2025.



906.412

Item No.	Measuring range/mm	Jaw length mm	Price RUB
906.412	0-150	40	
906.413	0-200	50	
906.414	0-300	60	

Options:
 495.214 Spare battery
 909.446 USB interface
 909.687 Foot switch



906.412

Digital calipers with rotatable LCD display

- Measuring range: 0-300 mm.
- Resolution: 0.01 mm.
- mm/inch conversion.
- On/off switch.
- Automatic switch-off.
- Reset.
- Rotatable display.
- Rotatable display value.
- Thumb wheel/locking screw/flat depth rod.
- Power supply: 1 battery type CR2032.



910.072

TECHNOBEARING



Item No.	Measuring range/mm	Jaw length mm	Price RUB
910.072	0-150	40	
910.073	0-200	50	
910.074	0-300	60	

Option:
 495.157 Spare battery

Absolute digital calipers IP54

Calipers with an absolute measuring system for easy incremental and absolute conversion. The advantage of these calipers is the one-time setting of the absolute zero position until the battery has to be changed. This reduces the chance of measuring errors and enables you to use the calipers

without zero setting. These calipers have a protection degree of IP54 and are therefore protected against splash water and resistant to oil and dust. The models with function for setting tolerance limits are provided with a clear optical Go (NoGo) indication.

- Measuring range: 0-300 mm.
- Resolution: 0.01 mm.
- mm/inch conversion.
- ABS/INC switchable.
- With data output.
- On/off switch.
- Automatic switch-off.
- Reset.

- Max. measuring speed: unlimited.
- Locking screw/flat depth rod.
- Protection: IP54.
- DIN 862.
- Delivery with an inspection report.
- Power supply: 1 battery type CR2032.

Models with tolerance display:

- Adjustable tolerance limits.
- Tolerance display by means of illuminated green LED at GO value.



906.835

NEW

USB interface:

- For data transfer to PC (e.g. Excel, Word).
- Operating system: Windows and other.
- PC connection: USB.
- No software or driver to install.
- Foot switch (optional).



906.618



909.687



906.619/910.038



Item No.	Measuring range/mm	Accuracy mm	Jaw length mm	Price RUB
906.838	0 - 150	0.02	40	
906.839	0 - 200	0.03	50	
906.840	0 - 300	0.03	60	
Models with tolerance display:				
906.835	0 - 150	0.02	40	
906.836	0 - 200	0.03	50	
906.837	0 - 300	0.03	60	
Options:				
495.157	Spare battery			
906.618	USB interface			
909.687	Footswitch for USB interface			
910.038	Wireless USB receiver			
906.619	Wireless transmitter			

Absolute digital calipers IP54

Calipers with an absolute measuring system for easy incremental and absolute conversion. This gives you the advantage that the caliper stores the one-time setting of the absolute zero position until the battery has to be changed. This reduces the chance of measuring errors and enables you to use the caliper without zero setting. These calipers have a protection degree of IP54 and are therefore protected against splash water and resistant to oil and dust.

- Measuring range: 0-300 mm.
- Resolution: 0.01 mm.
- mm/inch conversion.
- ABS/INC switchable.
- Digimatic data output.
- On/off switch.
- Reset.
- Max. measuring speed: unlimited.
- Thumb wheel supplied separately.
- Locking screw/flat depth rod.
- Protection: IP54.
- DIN 862.
- Delivery with an inspection report.
- Power supply: 1 battery type CR2032.

TECHNOBEARING

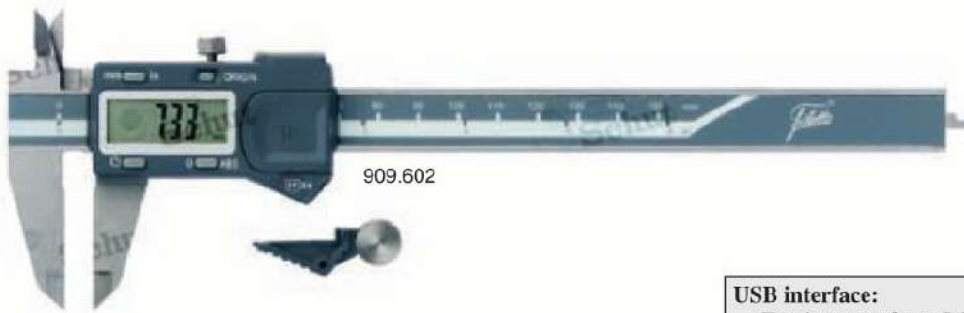

USB interface:

- For data transfer to PC (e.g. Excel, Word).
- Operating system: Windows and other.
- PC connection: USB.
- No software or driver to install.
- Foot switch (optional).



Item No.	Measuring range/mm	Accuracy mm	Jaw length mm	Price RUB
909.602	0 - 150	0.02	40	
909.603	0 - 200	0.02	50	
909.604	0 - 300	0.03	60	

Options:

- 495.157 Spare battery
- 909.686 USB interface
- 909.687 Footswitch for USB interface
- 910.038 Wireless USB receiver
- 910.039 Wireless transmitter

002-330 Technobearing 201 (9625)

Absolute digital calipers IP54

Calipers with an absolute measuring system for easy incremental and absolute conversion. This gives you the advantage that the caliper stores the one-time setting of the absolute zero position until the battery has to be changed. This reduces the chance of measuring errors and enables you to use the caliper without zero setting. These calipers have a protection degree of IP54 and are therefore protected against splash water and resistant to oil and dust.

- Measuring range: 0-300 mm.
- Resolution: 0.01 mm.
- mm/inch conversion.
- ABS/INC switchable.
- On/off switch.
- Automatic switch-off.
- Reset.
- Thumb wheel/locking screw/flat depth rod.
- Protection: IP54.
- DIN 862.
- Delivery with an inspection report.
- Power supply: 1 battery type CR2032.

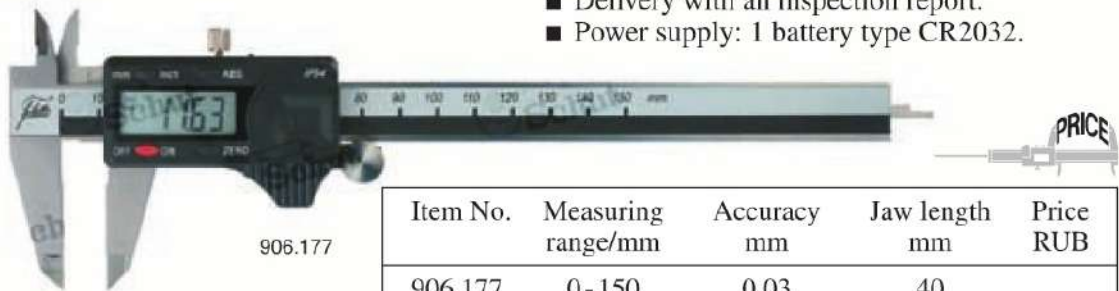

906.177

Item No.	Measuring range/mm	Accuracy mm	Jaw length mm	Price RUB
906.177	0 - 150	0.03	40	
906.178	0 - 200	0.03	50	
906.179	0 - 300	0.04	60	

Option:
495.157 Spare battery

TECHNOBEARING

Digital calipers IP54

These calipers have a protection degree of IP54 and are therefore protected against splash water and resistant to oil and dust.

- Measuring range: 0-300 mm.
- Resolution: 0.01 mm.
- mm/inch conversion.
- On/off switch.
- Reset.
- Thumb wheel/locking screw/flat depth rod.
- Protection: IP54.
- Power supply: 1 battery type V357.



907.900

Item No.	Measuring range/mm	Jaw length mm	Price RUB
907.900	0 - 150	40	
907.901	0 - 200	50	
907.902	0 - 300	60	

Option:
836.535 Spare battery

Digital carbon fiber calipers

Digital calipers made of carbon fiber.

- Measuring range: 0-300 mm.
- Resolution: 0.1 mm.
- mm/inch conversion.
- On/off switch.
- Automatic switch-off.
- Reset.
- Flat depth rod (only 909.420).
- Power supply:
909.420/688: 1 battery type CR2032,
909.689: 1 battery type V357.

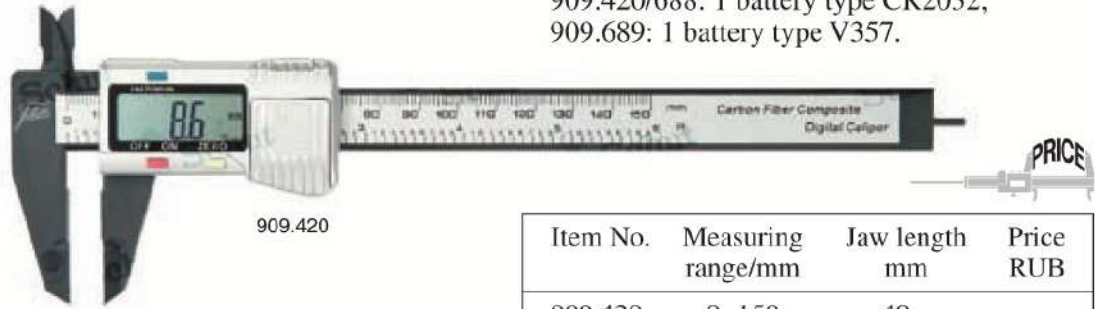

909.420

TECHNOBEARING

Item No.	Measuring range/mm	Jaw length mm	Price RUB
909.420	0-150	40	
909.688	0-150	75	
909.689	0-300	90.5	
Options:			
495.157	Spare battery type CR2032		
836.535	Spare battery type V357		

Digital calipers IP67

These IP67 protected calipers are especially suitable for use in production environments: they are fully protected against dust intrusion and even last temporary immersion.

- Measuring range: 0-300 mm.
- Resolution: 0.01 mm.
- mm/inch conversion.
- Automatic switch-off.
- Reset.
- Large LCD display.
- Thumb wheel/locking screw/flat depth rod.
- Protection: IP67.
- DIN 862.
- Delivery with an inspection report.
- Power supply: 1 battery type CR2032.



910.066

NEW



Item No.	Measuring range/mm	Accuracy mm	Jaw length mm	Price RUB
910.066	0-150	0.03	40	
910.067	0-200	0.03	50	
910.068	0-300	0.04	60	
With Bluetooth:				
910.069	0-150	0.03	40	
Option:				
495.157	Spare battery			

002.319 Technobearing 201 (9623)

Absolute digital calipers IP67

These IP67 protected calipers are especially suitable for use in production environments: they are fully protected against dust intrusion and even last temporary immersion.

Calipers with an absolute measuring system for easy incremental and absolute conversion. The advantage of these calipers is the one-time setting of the absolute zero position until the battery has to be changed. This reduces the chance of measuring errors and enables you to use the calipers without zero setting.

- Measuring range: 0-300 mm.
- Resolution: 0.01 mm.
- mm/inch conversion.
- ABS/INC switchable.
- On/off switch.
- Automatic switch-off.
- Reset.
- Locking screw/flat depth rod.
- Protection: IP67.
- DIN 862.
- Power supply: 1 battery type CR2032.



Item No.	Measuring range/mm	Jaw length mm	Price RUB
908.801	0-150	40	
908.802	0-200	50	
908.803	0-300	60	
Option:			
495.157	Spare battery		

Digital calipers IP67

These IP67 protected calipers are especially suitable for use in production environments: they are fully protected against dust intrusion and even lasts temporary immersion.

- Measuring range: 0-300 mm.
- Resolution: 0.01 mm.
- mm/inch conversion.
- On/off switch.
- Automatic switch-off.
- Reset.
- Thumb wheel/locking screw/flat depth rod.
- Protected rack.
- Protection: IP67.
- DIN 862.
- Delivery with an inspection report.
- Power supply: 1 battery type V357.

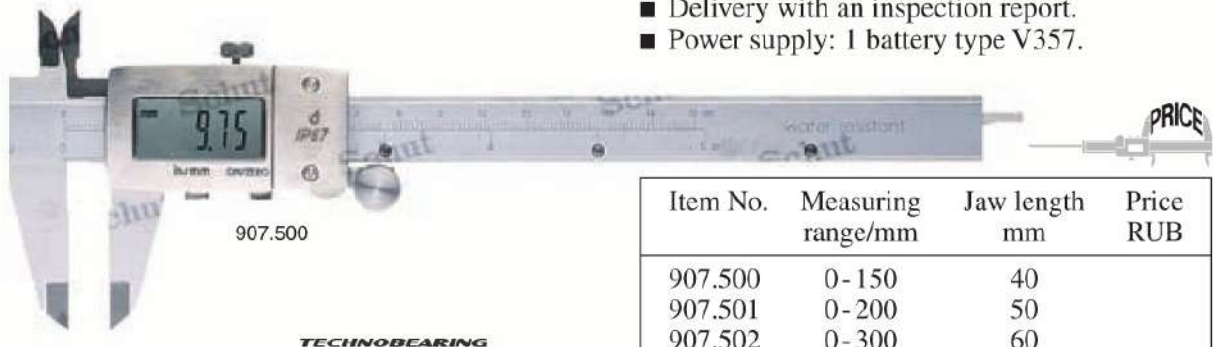

Item No.	Measuring range/mm	Jaw length mm	Price RUB
907.500	0-150	40	
907.501	0-200	50	
907.502	0-300	60	
Option:			
836.535	Spare battery		

Digital calipers with tungsten carbide measuring faces

- Measuring range: 0-300 mm.
- Resolution: 0.01 mm.
- mm/inch conversion.
- On/off switch.
- Reset.
- Thumb wheel/locking screw/flat depth rod.
- Tungsten carbide measuring faces.
- Power supply: 1 battery type V357.



TECHNOBEARING

Item No.	Measuring range/mm	Jaw length mm	Price RUB
910.035	0-150	40	
910.036	0-200	50	
910.037	0-300	60	

Option:
836.535 Spare battery

Digital calipers with large measuring faces

Calipers with large rectangular measuring faces for the measurements of for example round shafts and cables.

- Measuring range: 0-300 mm.
- Resolution: 0.01 mm.
- mm/inch conversion.
- On/off switch.
- Reset.
- Large LCD display.
- Locking screw.
- Power supply: 1 battery type V357.

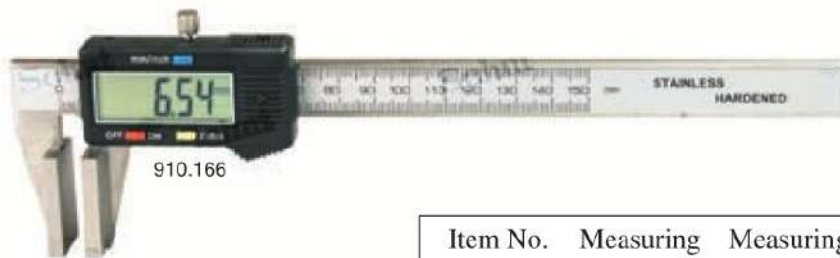

NEW

Item No.	Measuring range/mm	Measuring face width/mm	Measuring face height/mm	Price RUB
910.166	0-150	20	30	
910.167	0-200	30	40	
910.168	0-300	40	50	

Option:
836.535 Spare battery

Digital calipers with slidable measuring jaw

For measuring distances between planes at different levels. Very suitable as scribing tool!

- Measuring range: 0-500 mm.
- Resolution: 0.01 mm.
- mm/inch conversion.
- On/off switch.
- Reset.
- Large LCD display.
- Thumb wheel/locking screw.
- Power supply: 1 battery type V357 (except 906.348).

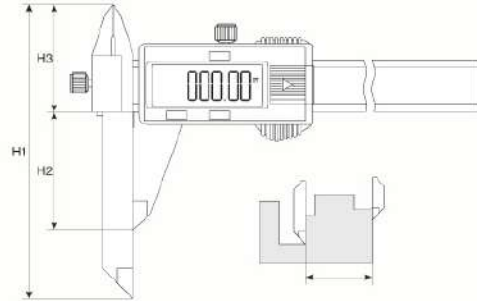

TECHNOBEARING

906.345



* Model with absolute digital display, without thumb wheel, with fine adjustment and preset function.

Item No.	Measuring range/mm	Jaw length/mm			Price RUB
		H1	H2	H3	
906.345	0 - 150	110	40	37	
906.346	0 - 200	120	50	40	
906.347	0 - 300	130	60	42	
906.348*	0 - 500	210	100	66	

Options:
 836.535 Spare battery type V357
 495.157 Spare battery type CR2032

Digital calipers for measuring center distances

Suited for measuring center distances between bores from $\phi 1$ up to 4.5 mm. Because both measuring jaws are adjustable in height it is possible to measure center distances between bores that are positioned at different levels.

- Measuring range: 5-300 mm.
- Resolution: 0.01 mm.
- mm/inch conversion.
- On/off switch.
- Reset.
- Large LCD display.
- Locking screw.
- Power supply: 1 battery type V357.



906.395

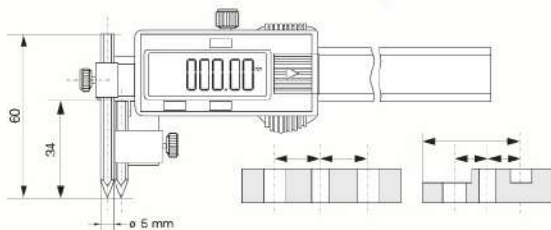

Item No.	Measuring range/mm	Price RUB
906.395	5 - 150	
906.396	5 - 200	
906.397	5 - 300	

Option:
 836.535 Spare battery

Digital calipers with pointed measuring jaws

The pointed measuring jaws of these calipers enable you to measure distances in places that are hard to reach.

- Measuring range: 0-300 mm.
- Resolution: 0.01 mm.
- mm/inch conversion.
- On/off switch.
- Reset.
- Large LCD display.
- Thumb wheel/locking screw/flat depth rod.
- Power supply: 1 battery type V357.

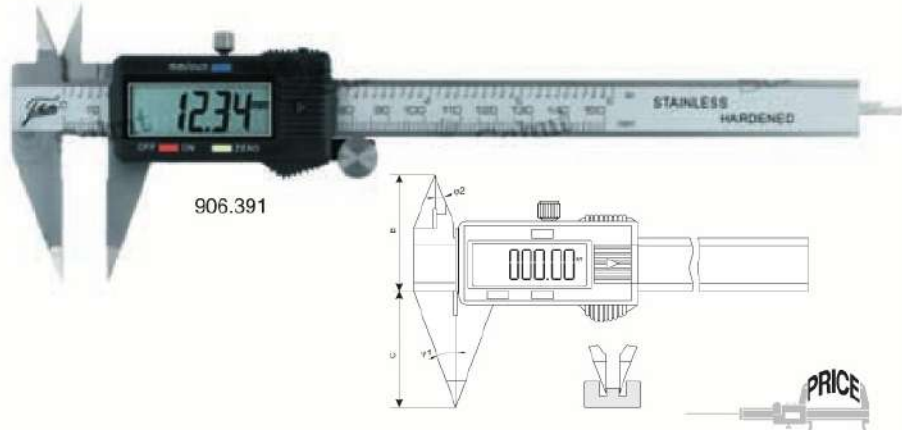

Item No.	Measuring range/mm	Jaw length C/mm	Length B/mm	Angle φ1	Angle φ2	Price RUB
906.391	0-150	40	37	20°	20°	
906.392	0-200	50	40	20°	22.5°	
906.393	0-300	60	42	20°	22.5°	

Option:
836.535 Spare battery

TECHNOBEARING

Digital calipers with outside angled measuring jaws

These calipers have short, stable, V-shaped measuring jaws with a flat front. Specially designed for measuring bore and internal groove diameters.

- Measuring range: 8-200 mm.
- Resolution: 0.01 mm.
- mm/inch conversion.
- On/off switch.
- Reset.
- Preset through SET switch.
- Thickness measuring face: 0.5 mm.
- Thumb wheel/locking screw.
- Delivery including setting ring 10 mm.
- Power supply: 1 battery type V357.

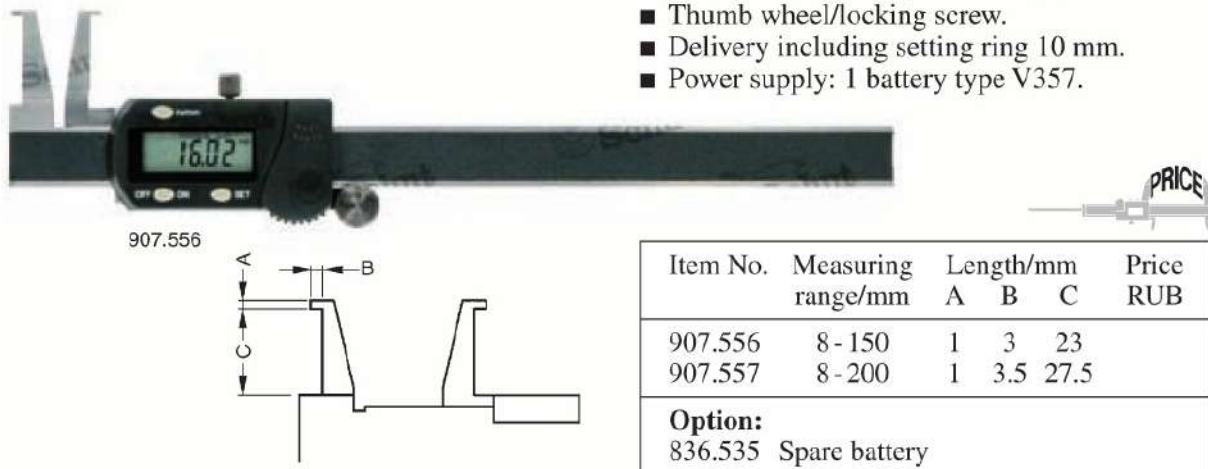

Item No.	Measuring range/mm	Length/mm			Price RUB
		A	B	C	
907.556	8-150	1	3	23	
907.557	8-200	1	3.5	27.5	

Option:
836.535 Spare battery

Digital calipers with outside angled measuring pins

These calipers are equipped with outside angled rounded pins.

- Measuring range: 35 - 500 mm.
- Resolution: 0.01 mm.
- mm/inch conversion.
- On/off switch.
- Reset.
- Large LCD display.
- Thumb wheel/locking screw.
- Power supply: 1 battery type V357 (except 906.383).

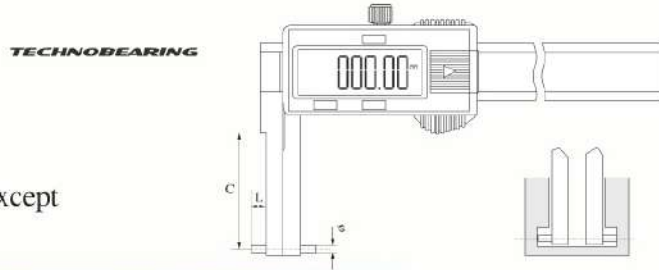

906.374

PRICE



* Model with absolute digital display, without thumb wheel, with fine adjustment and preset function.

Item No.	Measuring range/mm	Jaw length C/mm	Pin ϕ /mm	Pin length L/mm	Price RUB
906.374	35 - 150	60	2	6	
906.377	40 - 200	70	3	7	
906.380	50 - 300	80	3	10	
906.383*	60 - 500	105	3	10	
Options:					
836.535	Spare battery type V357				
495.157	Spare battery type CR2032				

Digital calipers with inside angled measuring pins

These calipers are equipped with inside angled rounded pins.

- Measuring range: 0 - 500 mm.
 - Resolution: 0.01 mm.
 - mm/inch conversion.
 - On/off switch.
 - Reset.
 - Large LCD display.
 - Thumb wheel/locking screw.
- Power supply: 1 battery type V357 (except 906.371).

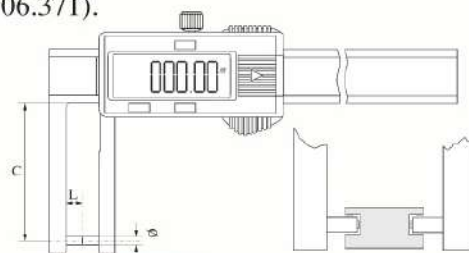

906.368

PRICE



* Model with absolute digital display, without thumb wheel, with fine adjustment and preset function.

Item No.	Measuring range/mm	Jaw length C/mm	Pin ϕ /mm	Pin length L/mm	Price RUB
906.368	0 - 150	40	2	5	
906.369	0 - 200	50	2.5	8	
906.370	0 - 300	60	2.5	10	
906.371*	0 - 500	100	3	12	
Options:					
836.535	Spare battery type V357				
495.157	Spare battery type CR2032				

Digital calipers with outside angled measuring jaws

These calipers are equipped with outside angled V-shaped measuring jaws.

- Measuring range: 35 - 500 mm.
- Resolution: 0.01 mm.
- mm/inch conversion.
- On/off switch.
- Reset.
- Large LCD display.
- Thumb wheel/locking screw.
- Power supply: 1 battery type V357 (except 906.363).

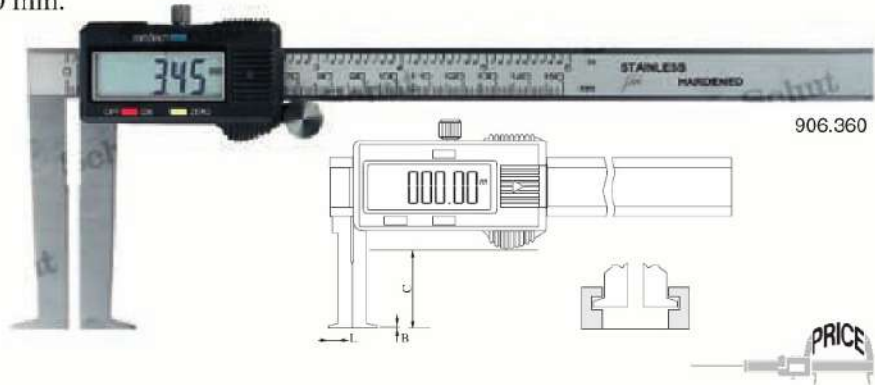

* Model with absolute digital display, without thumb wheel, with fine adjustment and preset function.

Item No.	Measuring range/mm	Jaw length C/mm	Measuring face B/mm	Jaw length L/mm	Price RUB
906.360	35 - 150	50	1.5	6	
906.361	40 - 200	60	1.5	7	
906.362	50 - 300	70	1.5	8	
906.363*	60 - 500	110	2	10	
Options:					
836.535	Spare battery type V357				
495.157	Spare battery type CR2032				

Digital calipers with inside angled measuring jaws

These calipers are equipped with inside angled V-shaped measuring jaws.

- Measuring range: 0 - 500 mm.
- Resolution: 0.01 mm.
- mm/inch conversion.
- On/off switch.
- Reset.
- Large LCD display.
- Thumb wheel/locking screw.
- Power supply: 1 battery type V357 (except 906.358).

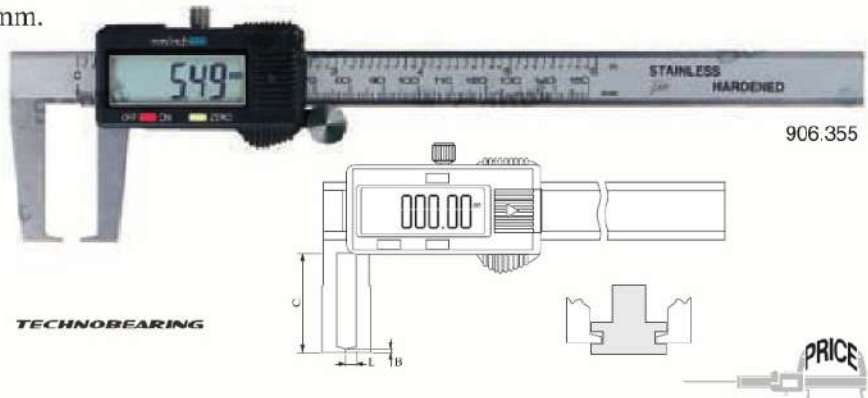

* Model with absolute digital display, without thumb wheel, with fine adjustment and preset function.

Item No.	Measuring range/mm	Jaw length C/mm	Measuring face B/mm	Jaw length L/mm	Price RUB
906.355	0 - 150	40	1	5	
906.356	0 - 200	50	1	7	
906.357	0 - 300	60	1.5	8	
906.358*	0 - 500	100	2	12	
Options:					
836.535	Spare battery type V357				
495.157	Spare battery type CR2032				

Digital calipers for internal length measurement

Calipers with outside angled, pointed measuring jaws for the measurement of for example internal grooves.

- Measuring range: 3 - 200 mm.
- Resolution: 0.01 mm.
- mm/inch conversion.
- On/off switch.
- Reset.
- Large LCD display.
- Locking screw.
- Power supply: 1 battery type V357.

906.386

Item No.	Measuring range/mm	Price RUB
906.386	3 - 125	
906.387	3 - 200	

Option:
836.535 Spare battery

Digital caliper for groove measurements

- Measuring range: 0 - 125 mm.
- Resolution: 0.01 mm.
- mm/inch conversion.
- On/off switch.
- Reset.
- Large LCD display.
- Equipped with small measuring jaws on top of the caliper.
- Thumb wheel/locking screw.
- Also suitable for:
 - internal diameter attached collar,
 - internal diameter U-shaped flange on axis,
 - center distances blind holes under-surface flange on axis,
 - hole diameter hard-to-reach places,
 - height measurement,
 - groove width and groove distance.
- Power supply: 1 battery type V357.

Item No.	Measuring range/mm	Price RUB
906.365	0 - 125	

Option:
836.535 Spare battery

Digital calipers with pointed anvil

Because of the pointed anvil and the long measuring jaws you can measure with these calipers all sorts of wall thicknesses in places that are hard to reach and of for example round surfaces.

- Measuring range: 0- 150 mm.
- Resolution: 0.01 mm.
- mm/inch conversion.
- On/off switch.
- Reset.
- Large LCD display.
- Power supply: 1 battery type V357.



Item No.	Measuring range/mm	Price RUB
906.350	0- 75	
906.351	0-125	
906.352	0-150	
Option:		
836.535	Spare battery	

Digital caliper with square, pointed anvil

Because of the pointed anvil and the long measuring jaws you can measure with this caliper all sorts of wall thicknesses in places that are hard to reach and of for example round surfaces.



- Measuring range: 0- 150 mm.
- Resolution: 0.01 mm.
- mm/inch conversion.
- On/off switch.
- Reset.
- Preset through SET switch.
- Anvil: height 1 mm, width 0.5 mm.
- Measuring face: height 6 mm, width 3 mm.
- Power supply: 1 battery type V357.

Item No.	Measuring range/mm	Length/mm			Price RUB
		A	B	C	
907.555	0- 150	95	10	3	
Option:					
836.535	Spare battery				

Digital calipers with prismatic anvil

Digital calipers with prismatic anvil for measuring objects with an uneven number of grooves like cutters, reamers and drills. The angle of the prism aperture is designed for workpieces having a number of 3 or 5 flutes.

- Measuring range: 1 - 40 mm.
- Resolution: 0.01 mm.
- Accuracy: ± 0.05 mm.
- mm/inch conversion.
- On/off switch.
- Reset.
- Preset through SET switch.
- Locking screw.
- Including setting gauge $\varnothing 4$ mm (907.552) or $\varnothing 1$ mm (907.553).
- Power supply: 1 battery type V357.



Item No.	For work-pieces with	Measuring range/mm	Price RUB
907.552	3 flutes	4 - 40	
907.553	5 flutes	1 - 40	
Option: 836.535 Spare battery			

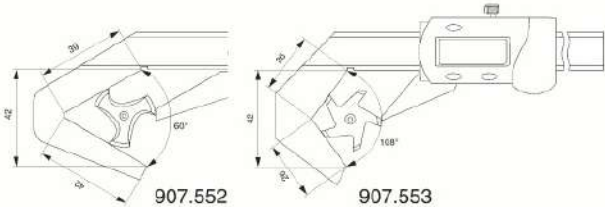

Digital gear tooth thickness calipers

The vertical slider sets the height (H) from the top of the tooth to the pitch line. Subsequently, the horizontal slider measures the tooth thickness (G) at the pitch line.

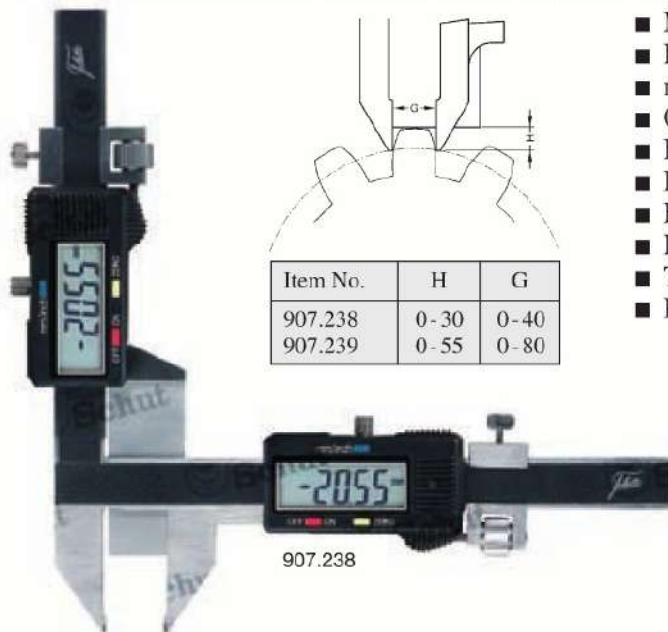

Item No.	H	G
907.238	0 - 30	0 - 40
907.239	0 - 55	0 - 80

- Measuring range: module 1 - 50.
- Resolution: 0.01 mm.
- mm/inch conversion.
- On/off switch.
- Reset.
- Large LCD display.
- Fine adjustment.
- Locking screw.
- Tungsten carbide measuring faces.
- Power supply: 2 batteries type V357.

Item No.	Module	Price RUB
907.238	1 - 30	
907.239	5 - 50	
Option: 836.535 Spare battery (2 needed)		

Digital calipers for internal measurements

Calipers with long measuring jaws for internal measurements.

- Measuring range: 15 - 300 mm.
- Resolution: 0.01 mm.
- mm/inch conversion.
- On/off switch.
- Reset.
- Large LCD display.
- Locking screw.
- Power supply: 1 battery type V357 (except 906.825/827/829).



906.824

Item No.	Measuring range/mm	Effective jaw length mm	Price RUB
906.824	15 - 150	50	
906.825*	25 - 150	130	
906.826	18 - 200	65	
906.827*	25 - 200	130	
906.828	20 - 300	80	
906.829*	25 - 300	130	



* Model with absolute digital display, fine adjustment and preset function.

Options:

- 836.535 Spare battery type V357
- 495.157 Spare battery type CR2032

TECHNOBEARING

Brake disc calipers

Brake disc calipers especially for measuring the groove depth of brake discs.

- Measuring range: 0-90 mm.
- Vernier: 0.1 mm.
- Locking screw.
- Stainless steel construction.



907.215

Item No.	Measuring range/mm	Jaw length mm	Price RUB
907.215	0-60	55	
907.216	0-60	80	
907.217	0-90	120	

Absolute digital workshop calipers

- Measuring range: 0-2000 mm.
- Resolution: 0.01 mm.
- mm/inch conversion.
- ABS/INC switchable (except 906.460/686/708).
- On/off switch.
- Reset.

TECHNOBEARING

- Preset (except 906.460/686/708).
- Memory for measuring values when the display is switched off.
- Fine adjustment.
- Rounded jaw ends for internal measurements.
- Locking screw.
- Power supply: 1 battery type CR2032 (except 906.460/686/708).

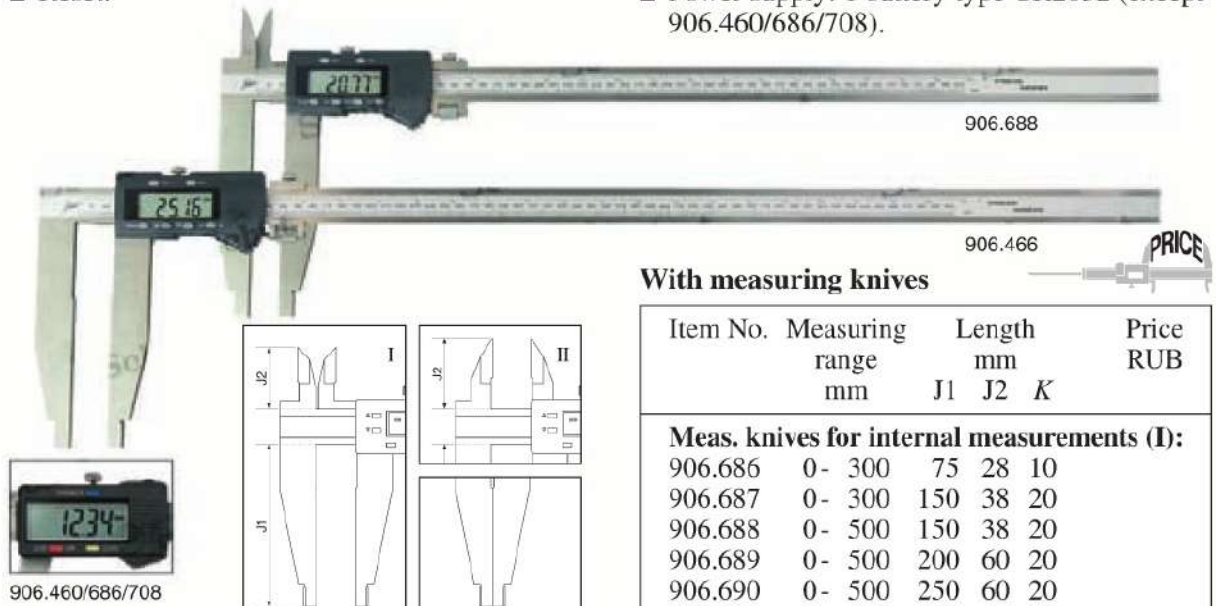

With measuring knives

Item No.	Measuring range mm	Length mm			Price RUB
		J1	J2	K	
Meas. knives for internal measurements (I):					
906.686	0- 300	75	28	10	
906.687	0- 300	150	38	20	
906.688	0- 500	150	38	20	
906.689	0- 500	200	60	20	
906.690	0- 500	250	60	20	
906.691	0- 600	150	45	20	
906.692	0- 600	200	60	20	
906.693	0- 600	300	60	20	
906.694	0-1000	200	60	20	
906.695	0-1000	300	60	20	
906.696	0-1500	200	60	20	
906.697	0-1500	300	60	20	
906.698	0-2000	200	60	20	
906.699	0-2000	300	60	20	

Without measuring knives

Item No.	Measuring range mm	Length mm		Price RUB
		J1	K	
906.708	0- 300	75	10	
906.709	0- 300	150	20	
906.465	0- 500	150	20	
906.470	0- 500	200	20	
906.718	0- 500	250	20	
906.466	0- 600	150	20	
906.471	0- 600	200	20	
906.719	0- 600	300	20	
906.467	0-1000	200	20	
906.472	0-1000	300	20	
906.468	0-1500	200	20	
906.473	0-1500	300	20	
906.469	0-2000	200	20	
906.474	0-2000	300	20	

Meas. knives for external measurements (II):

906.460	0- 300	75	38	10	
906.758	0- 300	150	56	20	
906.461	0- 500	150	56	20	
906.759	0- 500	200	67	20	
906.760	0- 500	250	80	20	
906.761	0- 600	150	56	20	
906.762	0- 600	200	67	20	
906.763	0- 600	300	80	20	
906.462	0-1000	200	67	20	
906.764	0-1000	300	80	20	
906.463	0-1500	200	80	20	
906.765	0-1500	300	80	20	
906.464	0-2000	200	80	20	
906.766	0-2000	300	80	20	

Item No.	Description	Price RUB
495.157	Spare battery type CR2032	
836.535	Spare battery type V357	

Digital lightweight workshop calipers

Lightweight digital aluminum workshop calipers with both measuring jaws moveable. Hardened stainless steel measuring jaws, with rounded jaw ends for internal and external measurements. Excellent sliding properties due to double prismatic joint.

- Measuring range: 0-800 mm.
- Resolution: 0.01 mm.
- mm/inch conversion.
- On/off switch.
- Reset.
- Jaw length standard delivered jaw: 90 mm.
- Length meas. knives for external measurements: 40 mm.
- Locking screws.
- Delivery in a case.
- Power supply: 1 battery type V357.

NEW



Item No.	Measuring range/mm	Accuracy mm	Weight kg	Price RUB
853.200	0-300	0.04	0.5	
853.201	0-500	0.05	0.6	
853.202	0-800	0.06	0.8	

Options:
 853.219¹ Pair measuring jaws 90 mm
 853.220 Pair measuring jaws 125 mm
 853.221 Pair measuring jaws 150 mm
 836.535 Spare battery

¹ Standard included.

Digital lightweight workshop calipers

Lightweight digital aluminum workshop calipers with both measuring jaws moveable. Hardened stainless steel measuring jaws, with rounded jaw ends for internal and external measurements. Excellent sliding properties due to double prismatic joint.

- Measuring range: 0-2000 mm.
- Resolution: 0.01 mm.
- On/off switch.
- Reset.
- Locking screws.
- Delivery in a case.
- Power supply: 1 battery type CR2032.

NEW

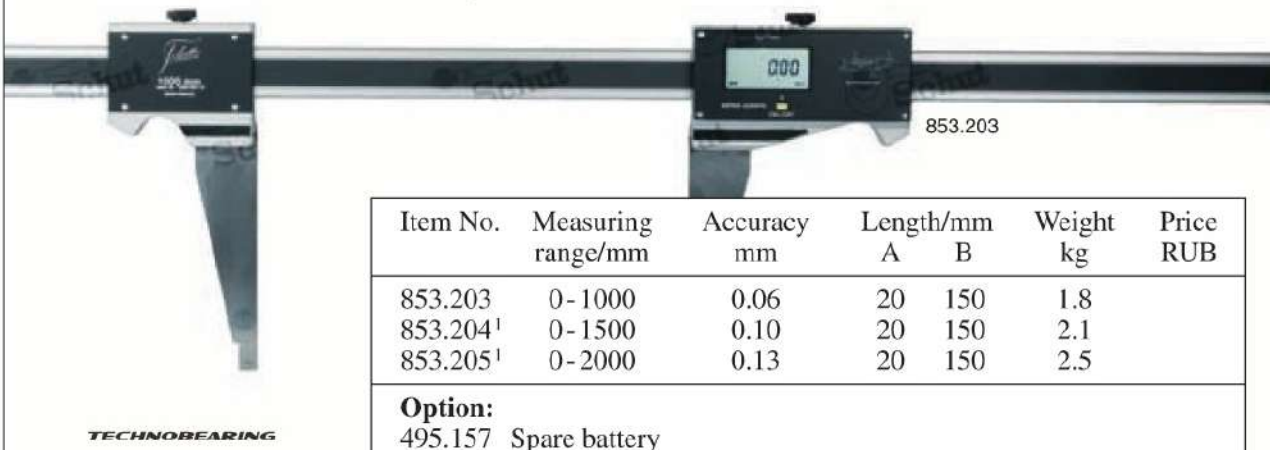

Item No.	Measuring range/mm	Accuracy mm	Length/mm		Weight kg	Price RUB
			A	B		
853.203	0-1000	0.06	20	150	1.8	
853.204 ¹	0-1500	0.10	20	150	2.1	
853.205 ¹	0-2000	0.13	20	150	2.5	

Option:
 495.157 Spare battery

¹ Delivery ex Groningen, Netherlands.

Digital aluminum workshop calipers

Lightweight digital aluminum workshop calipers with both measuring jaws moveable.

- Measuring range: 0 - 1500 mm.
- Resolution: 0.1 mm.
- mm/inch conversion.
- ABS/INC switchable.
- On/off switch.
- Reset.
- Aluminum scale with hollow construction (8 x 30 mm).
- Both of the measuring jaws can be moved.
- Power supply: 1 battery type V357.

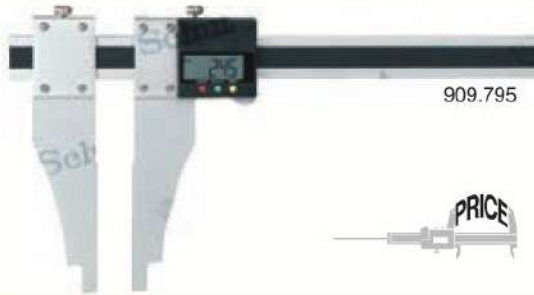

Item No.	Measuring range/mm	Measuring jaw/mm	Weight kg	Price RUB
909.795	0 - 500	150	0.7	
909.796	0 - 1000	150	0.9	
909.797	0 - 1500	150	1.1	
Option:				
836.535	Spare battery			

Digital lightweight universal workshop calipers

Universal lightweight aluminum workshop calipers with exchangeable measuring inserts for special purposes with both measuring jaws moveable. All inserts with M2.5 thread can be used with these calipers. Please see the dial indicator accessories section for these inserts.

- Internal measuring range¹: 30 - 1000 mm.
- External measuring range¹: 0 - 1000 mm.
- Resolution: 0.01 mm.
- mm/inch conversion.
- Tolerance function.
- On/off switch.
- Reset/preset.
- Measuring jaw: 100 mm.
- Interchangeable measuring inserts: 1 pair included (ball attachment $\varnothing 3.2$ mm, $l = 6$ mm).
- Fine adjustment.
- Locking screws.
- Delivery in a case.
- Power supply: 1 battery type CR2032.
- Larger sizes available on request.



Item No.	Measuring range/mm		Accuracy mm	Weight kg	Price RUB
	internal ¹	external ¹			
853.206	30 - 300	0 - 300	0.04	1	
853.207	40 - 500	0 - 500	0.05	1.3	
853.208	40 - 1000	0 - 1000	0.06	1.7	
Options:					
495.157	Spare battery				

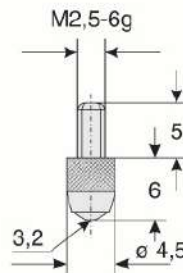

¹The measuring range can change depending on inserts.

Dial calipers

Stainless steel dial calipers with protected rack.

- Measuring range: 0-300 mm.
- Graduation: 0.01 or 0.02 mm.
- 1 pointer revolution = 1 or 2 mm.
- Rotatable dial.
- Thumb wheel.
- DIN 862.

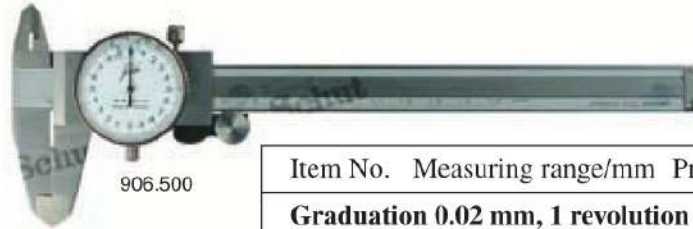

Item No.	Measuring range/mm	Price RUB
Graduation 0.02 mm, 1 revolution = 2 mm:		
906.500	0-150	
906.499	0-200	
906.501	0-300	
Graduation 0.01 mm, 1 revolution = 1 mm:		
906.498	0-150	



High-quality plastic calipers from Switzerland

These modern designed Swiss calipers are made of fiberglass re-enforced plastic, which makes them very firm and light, wear-proof, and resistant to all kinds of chemicals – ideal for the workshop! Each model is equipped with an easy read-out. Combined with the low price a line of very attractive calipers.

- Measuring range: 0-150 mm.
- Thumb wheel.
- Flat depth rod.
- DIN 862.
- Delivery in a case.

Vernier caliper

- Vernier: 0.1 mm / 1/64 inch.
- The scale lightens up with minimal light.

Dial caliper

- Graduation: 0.1 mm.
- 1 pointer revolution = 10 mm.
- Rotatable dial, ø 32 mm.
- The dial is shockproof and can be set to zero.

Digital caliper

- Resolution: 0.01 mm.
- mm/inch conversion.
- On/reset switch.
- Off switch.
- Power supply: 1 battery type V357.



TECHNOBEARING



837.209:
set with folding
rule of 1 m

Item No.	Description	Price RUB
837.207	Vernier caliper	
837.205	Dial caliper	
837.209	Set of dial caliper 837.205 with a folding rule of 1 m	
837.201	Digital caliper	
Option:		
836.535	Spare battery	

002-271- Technobearing 201 (9625)

Calipers

Hardened stainless steel calipers with no-glare chrome finished scale and vernier.

- Measuring range: 0-300 mm.
- Vernier: 0.05 or 0.02 mm.
- Raised sliders (except 909.538).
- Monoblock.
- Locking screw or spring release.
- Flat depth rod.
- Thread table on the back side.
- DIN 862.
- Delivery in a case.

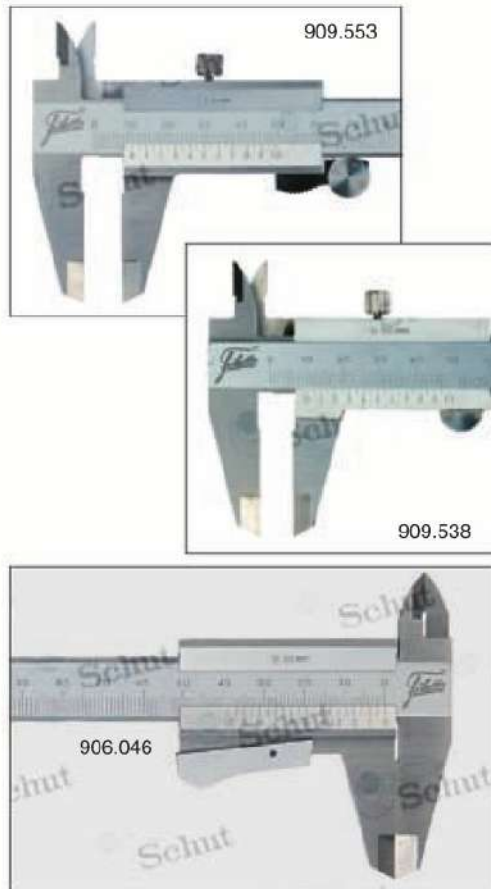
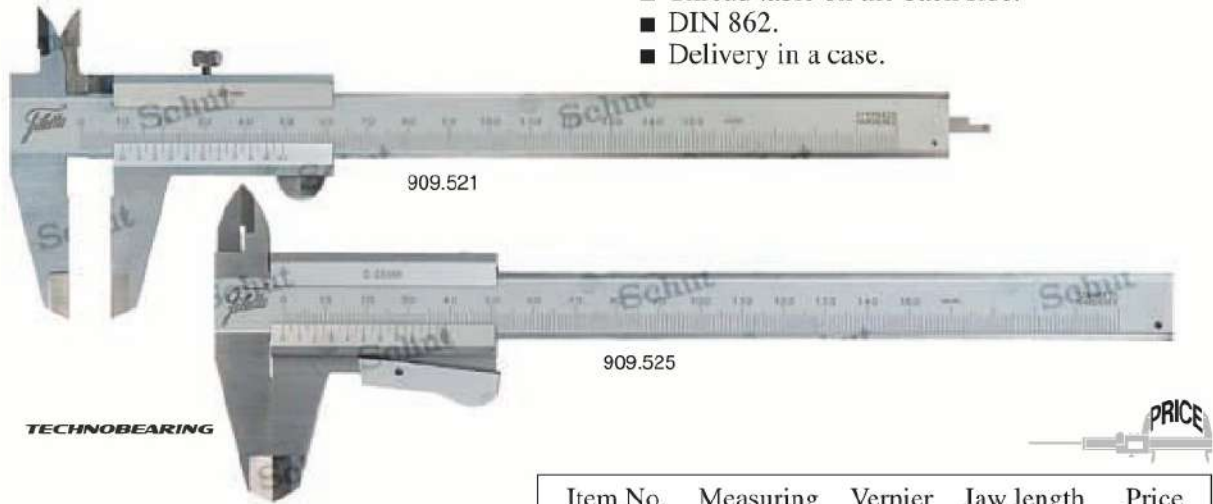

Item No.	Measuring range/mm	Vernier mm	Jaw length mm	Price RUB
Locking screw on top:				
909.541	0-150	0.02	40	
909.542	0-160	0.02	40	
909.543	0-200	0.02	50	
909.544	0-300	0.02	62	
Locking screw on top:				
909.520	0-100	0.05	30	
909.521	0-150	0.05	40	
909.522	0-160	0.05	40	
909.523	0-200	0.05	50	
909.524	0-300	0.05	62	
With thumb wheel (locking screw on top):				
909.553	0-150	0.05	40	
909.554	0-200	0.05	50	
909.555	0-300	0.05	62	
Parallax-free (locking screw on top):				
909.538	0-150	0.05	40	
Spring release:				
909.525	0-150	0.05	40	
909.526	0-160	0.05	40	
909.527	0-200	0.05	50	
909.528	0-300	0.05	62	
Spring release, left-handed model:				
906.046	0-150	0.05	40	
906.047	0-150	0.02	40	

Parallax-free lightweight workshop calipers

Lightweight parallax-free aluminum workshop calipers with exchangeable hardened stainless steel measuring jaws, with rounded jaw ends for internal and external measurements. High contrast reading due to white print on black background. Excellent sliding properties due to double prismatic joint.

- Measuring range: 0-900 mm.
- Vernier: 0.05 mm / 1/128 inch.
- Jaw length standard delivered jaw: 90 mm.
- Length meas. knives for external measurements: 40 mm.
- Parallax-free.
- Locking screw.
- Delivery in a case.

NEW



Item No.	Measuring range/mm	Weight kg	Price RUB
853.216	0-300	0.5	
853.217	0-500	0.6	
853.218	0-900	0.8	
Options:			
853.219 ¹	Pair measuring jaws 90 mm		
853.220	Pair measuring jaws 125 mm		
853.221	Pair measuring jaws 150 mm		

¹ Standard included.

Workshop calipers

Hardened stainless steel workshop calipers with no-glare chrome finished scale and vernier.

- Measuring range: 0-1500 mm.
- Vernier: 0.02 mm.
- Raised sliders.
- Fine adjustment.
- With measuring knives or rounded jaw ends for internal measurements.
- Locking screws.
- DIN 862.
- Delivery in a case.



906.230



Item No.	Measuring range mm	Internal measurements from/mm	Jaw length mm	Price RUB
With measuring knives for internal measurements:				
906.230	0- 300	-	65	
With rounded jaw ends for internal measurements:				
906.231	0- 300	10	80	
906.233	0- 500	10	100	
906.234	0- 600	10	100	
906.235	0-1000	20	125	
906.236	0-1500	20	125	



906.233

TECHNOBEARING

002-218 Technobearing 201 (9623)

Workshop calipers

Large and solid, stainless steel calipers with no-glare chrome finished scale and vernier.

- Measuring range: 0-2000 mm.
- Vernier: 0.02 mm / 1/1000 inch or 0.05 mm / 1/128 inch.
- Fine adjustment.
- With or without measuring knives for internal or external measurements.
- Monoblock.
- Rounded jaw ends for internal measurements; measuring range ≤600 mm: K=10 mm, measuring range >600 mm: K=20 mm.
- Locking screws.
- DIN 862.
- Delivery in a case with a declaration of conformity.

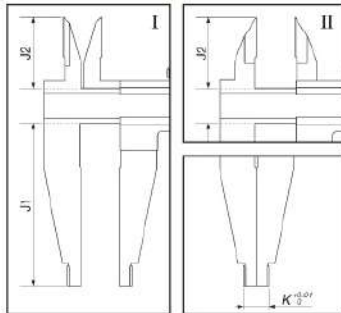

Vernier 0.05 mm / 1/128 inch

Item No.	Measuring range mm	Length mm			Price RUB
		J1	J2	K	
Without measuring knives:					
909.670	0- 300	90	-	10	
909.620	0- 450	150	-	10	
909.621	0- 500	150	-	10	
909.622	0- 600	150	-	10	
909.623	0- 800	150	-	20	
909.624	0-1000	150	-	20	
909.639	0-1500	200	-	20	
909.640	0-2000	200	-	20	
Meas. knives for internal measurements (I):					
909.672	0- 300	90	22	10	
909.632	0- 400	100	46	10	
909.633	0- 500	150	46	10	
909.634	0- 600	150	46	10	
909.635	0- 750	150	54	20	
909.636	0-1000	150	54	20	
909.637	0-1500	200	66	20	
909.638	0-2000	200	66	20	
Meas. knives for external measurements (II):					
909.674	0- 300	90	22	10	
909.656	0- 400	100	46	10	
909.657	0- 500	150	46	10	
909.658	0- 600	150	46	10	
909.659	0- 750	150	54	20	
909.660	0-1000	150	54	20	
909.661	0-1500	200	66	20	
909.662	0-2000	200	66	20	

Vernier 0.02 mm / 1/1000 inch

Item No.	Measuring range mm	Length mm			Price RUB
		J1	J2	K	
Without measuring knives:					
909.671	0- 300	90	-	10	
909.615	0- 450	150	-	10	
909.616	0- 500	150	-	10	
909.617	0- 600	150	-	10	
909.618	0- 800	150	-	20	
909.619	0-1000	150	-	20	
909.641	0-1500	200	-	20	
909.642	0-2000	200	-	20	
Meas. knives for internal measurements (I):					
909.673	0- 300	90	22	10	
909.625	0- 400	100	46	10	
909.626	0- 500	150	46	10	
909.627	0- 600	150	46	10	
909.628	0- 750	150	55	20	
909.629	0-1000	150	55	20	
909.630	0-1500	200	66	20	
909.631	0-2000	200	66	20	
Meas. knives for external measurements (II):					
909.675	0- 300	90	22	10	
909.663	0- 400	100	46	10	
909.664	0- 500	150	46	10	
909.665	0- 600	150	46	10	
909.666	0- 750	150	55	20	
909.667	0-1000	150	55	20	
909.668	0-1500	200	66	20	
909.669	0-2000	200	66	20	

Probe set for calipers

This probe set enlarges the possibilities of a regular caliper. Probe holders are slid on the measuring jaw of the caliper. The different probes can be screwed onto them. The probe set makes it possible to execute measurements which are not possible with a regular caliper, such as measuring internal grooves and center distances.

- Maximum jaw thickness: 3.2 mm.
- Delivery in a wooden case.

TECHNOBEARING



The set consists of:

- ① right probe holder,
- ② left probe holder,
- ③ pair of disc probes $\varnothing 6$ mm,
- ④ pair of disc probes $\varnothing 10$ mm,
- ⑤ pair of disc probes $\varnothing 12.5$ mm,
- ⑥ pair of cone probes $\varnothing 9$ mm, 60° ,
- ⑦ pair of cone probes $\varnothing 12.5$ mm, 60° ,
- ⑧ pair of cylindrical probes $\varnothing 1.5 \times 9$ mm,
- ⑨ hexagon key.

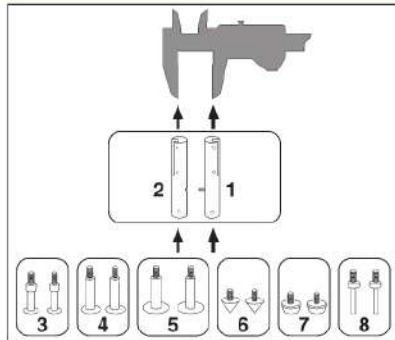

Item No.	Description	Price RUB
909.655	Probe set for calipers	

\varnothing		
6 mm	>16 mm	>4 mm
10 mm	>20 mm	>1 mm
12.5 mm	>22 mm	>0 mm

3, 4, 5
Disc probes for internal measurements.

6
Conical probes (9 mm) for measuring center distances of two equal holes.

7
Conical probes (12.5 mm) for measuring center distances of two equal holes.

8
Horizontally positioned cylindrical probes for measuring internal grooves > 45 mm.

8
Vertically positioned cylindrical probes.

Caliper inspection set

For checking the accuracy of DIN 862 calipers. The set consists of three special steel gauge blocks (30 mm, 41.3 mm and 131.4 mm, ISO 3650 class 1), two steel setting rings (ø4 mm and ø25 mm) and a pair of gloves.



Item No.	Description	Price RUB
909.347	Caliper inspection set	

Depth measuring base for calipers

Universal depth measuring base for stable and accurate depth measurements. Suitable for most of the calipers with a depth rod and a measuring range up to 200 mm. For more information please contact our sales department.

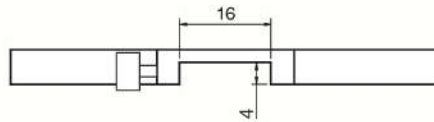

Item No.	Measuring face l x w/mm	Price RUB
909.156	75 x 6	

Depth measuring bases for calipers

Universal depth measuring bases for stable and accurate depth measurements. Suitable for most of the calipers with a depth rod and a measuring range up to 200 mm. For more information please contact our sales department.



909.386

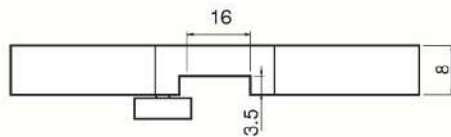

Item No.	Measuring face l x w/mm	Price RUB
909.386	80 x 8	
909.387	100 x 8	

TECHNOBEARING

002.310. Technobearing 201 (RUB25)

Caliper holder

Plastic holder for calipers (analog and digital; regular shaped) of 150 mm.

- For regular shaped calipers (analog and digital).
- Delivery including mounting set.
- Rotatable 360°.



NEW



TECHNOBEARING

Item No.	For meas. range/mm	Price RUB
360.000	150	

Plastic hard cases for calipers

Protect calipers during transport and storage.

- For regular shaped calipers (analog, digital and dial type).

NEW

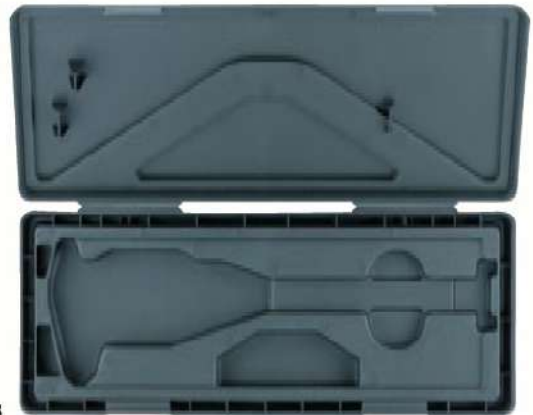

910.108

Item No.	For meas. range/mm	Price RUB
910.108	150	
910.109	200	
910.110	300	

Soft cases for calipers

Protect calipers during transport and storage.

- For regular shaped vernier calipers.
- Made of synthetic leather.



909.495

Item No.	For meas. range/mm	Price RUB
909.494	100	
909.495	150	
909.496	160	
909.497	200	
909.498	300	

Depth calipers

- Measuring range: 0-500 mm.
- Analog: vernier 0.02 mm, digital: resolution 0.01 mm.
- With or without hook (8 x 3 mm, l x w).
- Locking screw.

Analog

- Stainless steel construction.
- No-glare chrome finished scale and vernier.

Digital

- mm/inch conversion.
- On and off switches.
- Reset.
- Power supply: 1 battery type V357.

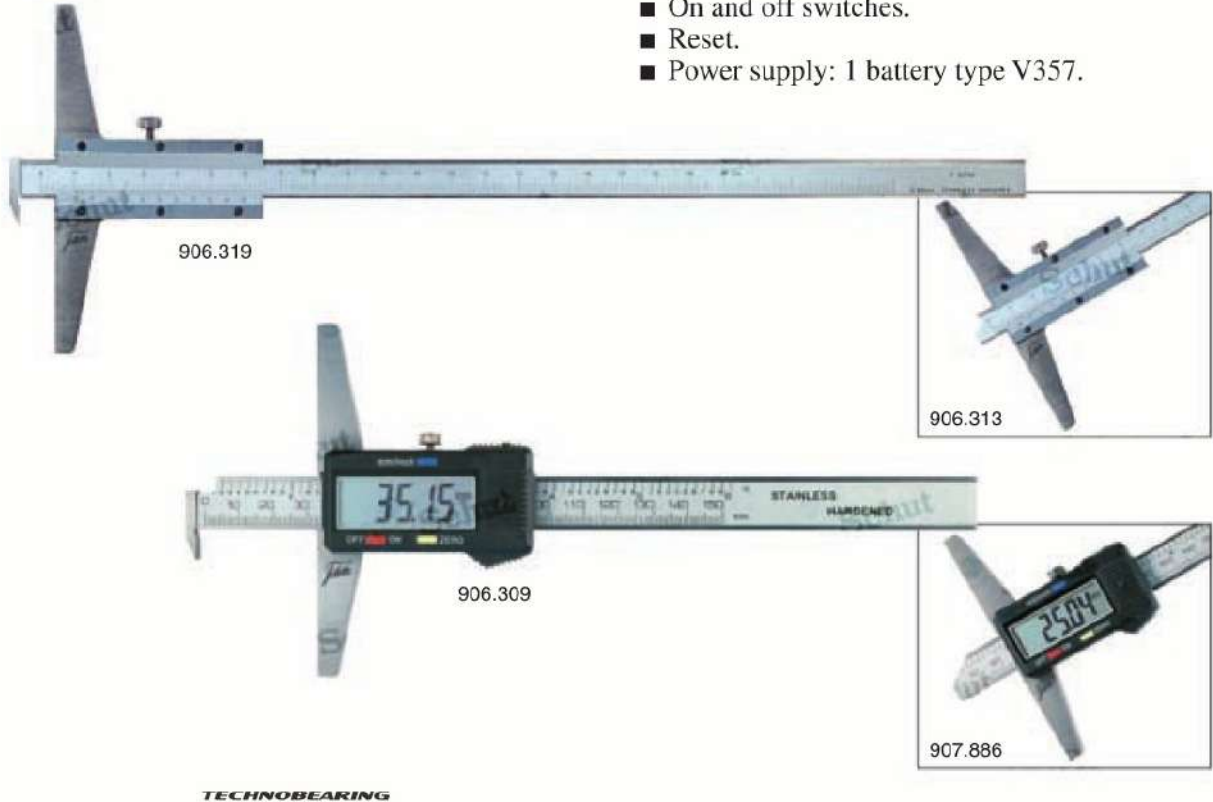

Analog

Item No.	Measuring range/mm	Base length/mm	Price RUB
Without hook:			
906.314	0-150	100	
906.313	0-200	100	
906.315	0-300	100	
906.317	0-500	100	
With hook:			
906.318	0-150	100	
906.319	0-200	100	
906.321	0-300	100	
906.322	0-500	100	

Digital

Item No.	Measuring range/mm	Base length/mm	Price RUB
Without hook:			
907.886	0-150	100	
907.887	0-200	100	
907.888	0-300	100	
907.898	0-500	100	
With hook:			
906.309	0-150	100	
906.310	0-200	100	
906.311	0-300	100	
906.312	0-500	100	
Option:			
836.535	Spare battery		



Depth calipers

Depth calipers with or without hook.

- Measuring range: 0-300 mm.
- Vernier: 0.05 mm.
- Locking screw.
- No-glare chrome finished scale and vernier.
- Monoblock.
- Stainless steel construction.
- DIN 862.
- Larger measuring ranges available on request.



909.910



909.916

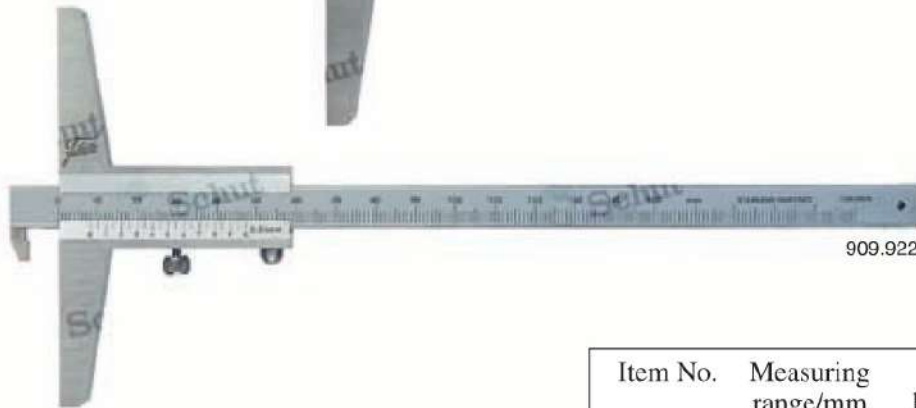

909.922

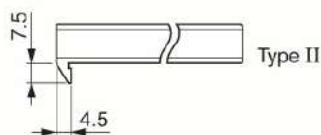
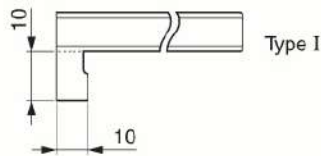

Item No.	Measuring range/mm	Base length/mm	Price RUB
Without hook:			
909.910	0-150	100	
909.911	0-200	100	
909.912	0-300	100	
With hook (type I):			
909.916	0-150	100	
909.917	0-200	100	
909.918	0-300	100	
With hook (type II):			
909.922	0-150	100	
909.923	0-200	100	
909.924	0-300	100	

Digital lightweight depth calipers

Universal lightweight aluminum depth calipers with two exchangeable measuring inserts set at 90 degrees and 3 measuring bases. All inserts with M2.5 thread can be used with these calipers. Please see the dial indicator accessories section for these inserts. Excellent sliding properties due to double prismatic joint.

- Measuring range: 0-800 mm.
- Resolution: 0.01 mm.
- mm/inch conversion.
- On/off switch.
- Reset/preset.
- Length included measuring bases: 150, 300 and 450 mm.
- Interchangeable measuring inserts: 2 measuring inserts included (ball attachments $\phi 3.2$ mm, $l=6$ mm and $\phi 5$ mm, $l=12$).
- Locking screw.
- Delivery in a case.
- Power supply: 1 battery type V357.

Item No.	Measuring range/mm	Accuracy mm	Weight kg	Price RUB
853.209	0-300	0.04	0.4	
853.210	0-500	0.05	0.5	
853.211	0-800	0.06	0.8	

Options:
836.535 Spare battery



Digital lightweight depth calipers with with round depth rod

Universal lightweight aluminum depth calipers with round depth rod with M2.5 threaded hole for exchangeable inserts. Inserts with M2.5 thread can be used with these calipers. Please see the dial indicator accessories section for these inserts. Excellent sliding properties due to double prismatic joint.

- Measuring range: 0-800 mm.
- Diameter depth rod:
Measuring range 0-300 mm $\phi 4$ mm
Measuring range 500-800 mm $\phi 6$ mm.
- Resolution: 0.01 mm.
- mm/inch conversion.
- On/off switch.
- Reset.
- Length included measuring base: 350 mm.
- Interchangeable measuring inserts: 2 measuring inserts included (ball attachment $\phi 3.2$ mm, $l=6$ mm and disc attachment $\phi 20$ mm, $d=2$).
- Locking screw.
- Delivery in a case.
- Power supply: 1 battery type V357.



Item No.	Measuring range/mm	Accuracy mm	Weight kg	Price RUB
853.212	0-200	0.03	0.3	
853.213	0-300	0.04	0.4	
853.214	0-500	0.05	0.6	
853.215	0-800	0.06	0.8	

Options:
853.222 Measuring base 550 mm
853.223 Measuring base 750 mm
853.224 Measuring base 950 mm
836.535 Spare battery

NEW

002-339 Technobearing 201 (RUB)

Digital depth gauge

- Measuring range: 0-21.5 mm.
- Resolution: 0.01 mm.
- mm/inch conversion.
- On/off switch.
- Reset.
- Large LCD display.
- Locking screw.
- Measuring face: 45 x 6 mm.
- Measuring pin: 6 x 2 mm, taper to 4 x 2 mm.
- Power supply: 1 battery type V357.



Item No.	Measuring range/mm	Price RUB
907.861	0-21.5	
Option:		
836.535	Spare battery	

Digital depth gauge

- Measuring range: 0-80 mm.
- Resolution: 0.05 mm.
- mm/inch conversion.
- On/off switch.
- Detachable measuring pin ϕ 4.3 mm, length 50 mm.
- Power supply: 1 battery type CR2032.



Item No.	Measuring range/mm	Price RUB
906.428	0-80	
Option:		
495.157	Spare battery	

Depth calipers for keyway depths

- Measuring range: keyway depths 0-60 mm.
- Application range: cylinders ϕ 5-200 mm.
- Vernier: 0.05 mm.
- Stainless steel construction.



Item No.	Application range/mm	Price RUB
907.192	ϕ 5- 80	
907.193	ϕ 6-120	
907.194	ϕ 7-160	
907.195	ϕ 8-200	

Käfer depth dial indicators

- Measuring range: 0-30 mm.
- Graduation: 0.01 mm.
- Measuring pin shaft: ϕ 2 mm.
- Measuring depth with pin 852.385: 200 mm.
- Excl. measuring pin and measuring base.
- Accuracy according DIN 878 (852.383) or factory standard (852.384).

TECHNOBEARING



Item No.	Measuring range/mm	Price RUB
852.383	0-10	
852.384	0-30	
Options:		
852.385	Measuring pin ϕ 2 mm, 340 mm	
907.153	Meas. base 63 x 17 mm	
907.165	Meas. base 101.5 x 17 mm*	

* Larger sizes available on request.

002-2332 Technobearing 201 (94623)

Digital depth micrometers IP65

Digital depth micrometers with interchangeable, spherical rods or flat rods. With the flat rods mainly flat and spherical surfaces can be measured very accurately. The spherical rods are especially suitable for beveled and hollow surfaces. The high accuracy of the rods makes resetting after exchanging the rods unnecessary. Two models with different base lengths available.

- Measuring range: 0-300 mm.
- Resolution: 0.001 mm.
- mm/inch conversion.
- ABS/INC switchable.
- Automatic switch-off.
- Preset.
- Measuring rods: $\varnothing 4.5$ mm.
- Locking screw.
- Protection: IP65.
- DIN 863 T2.
- Power supply: 1 battery type V357.



Model with spherical rods especially for hollow and beveled surfaces

Item No.	Price RUB	Item No.	Price RUB	Measuring range/mm	Accuracy mm	Number of rods
Base 63 mm:		Base 101.5 mm:				
909.753		909.759		0- 25	± 0.005	1
909.754		909.760		0- 50	± 0.005	2
909.755		909.761		0-100	± 0.006	4
909.756		909.762		0-150	± 0.007	6
909.757		909.763		0-200	± 0.008	8
909.758		909.764		0-300	± 0.009	12

Model with flat rods especially for flat and spherical surfaces

Item No.	Price RUB	Item No.	Price RUB	Measuring range/mm	Accuracy mm	Number of rods
Base 63 mm:		Base 101.5 mm:				
909.765		909.771		0- 25	± 0.005	1
909.766		909.772		0- 50	± 0.005	2
909.767		909.773		0-100	± 0.006	4
909.768		909.774		0-150	± 0.007	6
909.769		909.775		0-200	± 0.008	8
909.770		909.776		0-300	± 0.009	12

Option

Item No.	Description	Price RUB
836.535	Spare battery	

TECHNOBEARING

002-2330 Technobearing 201 (04625)

Depth micrometers

Depth micrometers with interchangeable, spherical or flat rods. With the flat rods mainly flat and spherical surfaces can be measured very accurately. The spherical rods are especially suitable for beveled and hollow surfaces. The high accuracy of the rods makes recalibration after exchanging the rods unnecessary. Two models with different base lengths available.

- Measuring range: 0-300 mm.
- Graduation: 0.01 mm.
- Measuring rods: $\varnothing 4.5$ mm.
- Locking screw.
- DIN 863 T2.



906.970



906.040



Model with spherical rods especially for hollow and beveled surfaces

Item No.	Price RUB	Item No.	Price RUB	Measuring range/mm	Accuracy mm	Number of rods
Base 63 mm:		Base 101.5 mm:				
906.964		906.040		0- 25	± 0.005	1
906.965		906.039		0- 50	± 0.005	2
906.966		906.041		0-100	± 0.006	4
906.967		906.042		0-150	± 0.007	6
906.968		906.043		0-200	± 0.008	8
906.969		906.044		0-300	± 0.009	12

Model with flat rods especially for flat and spherical surfaces

Item No.	Price RUB	Item No.	Price RUB	Measuring range/mm	Accuracy mm	Number of rods
Base 63 mm:		Base 101.5 mm:				
906.970		906.976		0- 25	± 0.005	1
906.971		906.977		0- 50	± 0.005	2
906.972		906.978		0-100	± 0.006	4
906.973		906.979		0-150	± 0.007	6
906.974		906.980		0-200	± 0.008	8
906.975		906.981		0-300	± 0.009	12

002.275 Technobearing 201 (9623)

Micrometers / Micrometer heads

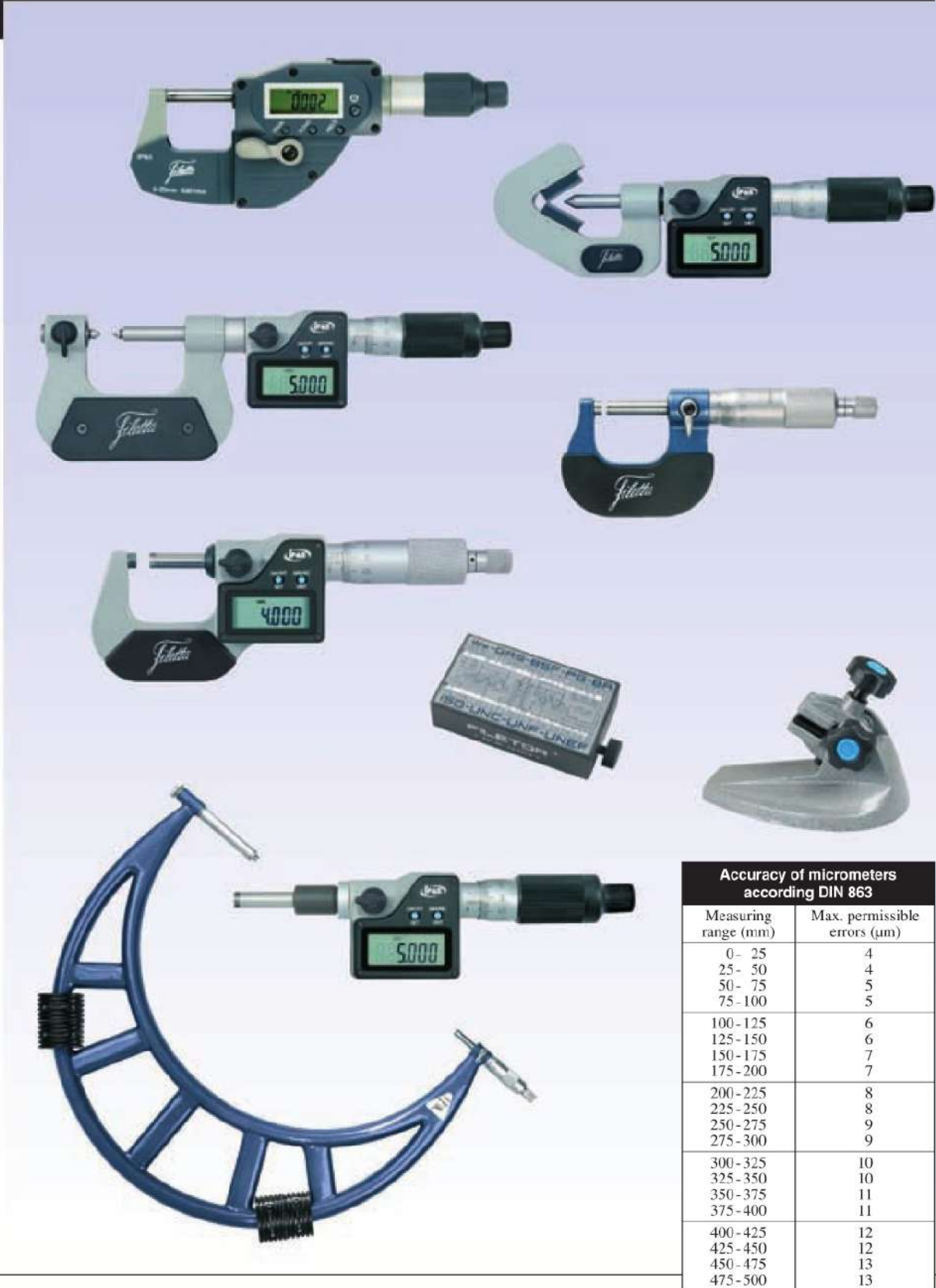

Accuracy of micrometers according DIN 863	
Measuring range (mm)	Max. permissible errors (µm)
0 - 25	4
25 - 50	4
50 - 75	5
75 - 100	5
100 - 125	6
125 - 150	6
150 - 175	7
175 - 200	7
200 - 225	8
225 - 250	8
250 - 275	9
275 - 300	9
300 - 325	10
325 - 350	10
350 - 375	11
375 - 400	11
400 - 425	12
425 - 450	12
450 - 475	13
475 - 500	13

001.001. Technobearing 201 (REB25)

Digital micrometers

Rugged digital micrometers with simple functions and an excellent price-performance ratio.

- Measuring range: 0-200 mm.
- Resolution: 0.001 mm.
- Automatic switch-off.
- Reset/preset.
- Tungsten carbide measuring faces: $\varnothing 6.5$ mm.
- DIN 863 T1.
- From measuring range 25 - 50 mm including setting gauge.
- Power supply: 1 battery type V357.



TECHNOBEARING



908.769

Item No.	Measuring range/mm	Accuracy mm	Price RUB
Not switchable:			
908.751	25- 50	± 0.004	
908.752	50- 75	± 0.005	
908.753	75-100	± 0.005	
908.754	100-125	± 0.006	
908.755	125-150	± 0.006	
908.756	150-175	± 0.007	
908.757	175-200	± 0.007	
Switchable mm/inch and ABS/INC:			
908.758	0- 25	± 0.004	
908.759	25- 50	± 0.004	
908.760	50- 75	± 0.005	
908.761	75-100	± 0.005	
908.762	100-125	± 0.006	
908.763	125-150	± 0.006	
908.764	150-175	± 0.007	
908.765	175-200	± 0.007	

Sets

Item No.	Measuring range/mm	Pieces	Price RUB
Not switchable:			
908.766	0- 75	3	
908.767	0-100	4	
Switchable mm/inch and ABS/INC:			
908.769	0- 75	3	
908.770	0-100	4	
908.771	0-150	6	

Option

Item No.	Description	Price RUB
836.535	Spare battery	

Digital micrometers

Rugged digital micrometers with simple functions and an excellent price-performance ratio.

- Measuring range: 0-150 mm.
- Resolution: 0.001 mm.
- mm/inch conversion.
- ABS/INC switchable.
- Automatic switch-off.
- Reset/preset.
- Tungsten carbide measuring faces: $\phi 6.5$ mm.
- From measuring range 25 - 50 mm including setting gauge.

- Delivery in a case with ball attachment and an inspection report.
- Power supply: 1 battery type CR2032.



Item No.	Measuring range/mm	Accuracy mm	Price RUB
909.982	0- 25	± 0.003	
909.983	25- 50	± 0.003	
909.984	50- 75	± 0.004	
909.985	75-100	± 0.004	
909.986	100-125	± 0.005	
909.987	125-150	± 0.005	
Option:			
495.157	Spare battery		

Digital micrometers with double display

This patented micrometer distinguishes itself by its the two large displays on both sides of the instrument, which can also display upside-down. Therefore the measuring value can always be presented upright, which enables ergonomic read-out at all times. Add to this its measuring range of 30 mm, the tungsten carbide measuring faces and then check out its price.

- Measuring range: 0-205 mm.
- Resolution: 0.001 mm.
- mm/inch conversion.
- ABS/INC switchable.
- Double LCD display.
- Second display can be switched on/off separately.

TECHNOBEARING

- Automatic switch-off.
- Reset/preset.
- Tungsten carbide measuring faces: $\phi 6.5$ mm.
- DIN 863 T1.
- From measuring range 25 - 55 mm including setting gauge.
- Delivery in a case.
- Power supply: 1 battery type CR2032.



Item No.	Measuring range/mm	Accuracy mm	Price RUB
907.682	0- 30	± 0.004	
907.683	25- 55	± 0.004	
907.684	50- 80	± 0.005	
907.685	75-105	± 0.005	
907.686	100-130	± 0.006	
907.687	125-155	± 0.006	
907.688	150-180	± 0.007	
907.689	175-205	± 0.007	
Option:			
495.157	Spare battery		

Digital micrometers with tolerance indication

These absolute digital micrometers are provided with both a tolerance and a hold function. They also have a large display.

- Measuring range: 0-100 mm.
- Resolution: 0.001 mm.
- mm/inch conversion.
- ABS/INC switchable.
- Digit height: 9 mm.
- Automatic switch-off.
- Reset/preset.
- Hold function.
- Adjustable tolerance limits.
- Tungsten carbide measuring faces: $\varnothing 6.5$ mm.
- DIN 863 T1.
- Power supply: 1 battery type V357.



907.570

TECHNOBEARING



Item No.	Measuring range/mm	Accuracy mm	Price RUB
907.570	0- 25	± 0.004	
907.571	25- 50	± 0.004	
907.572	50- 75	± 0.005	
907.573	75-100	± 0.005	
Option:			
836.535	Spare battery		

Micrometers with counter

These solid micrometers have a counter with a resolution of 0.01 mm for an error free read-out of the measuring value, and a very favourable price-performance ratio.

- Measuring range: 0-200 mm.
- Resolution: 0.01 mm.
- Numerical counter adjustable.
- Tungsten carbide measuring faces: $\varnothing 6.5$ mm.
- Delivery with adjustment tool.
- From measuring range 25- 50 mm including setting gauge.



906.556



Sets (delivered incl. setting gauges)

Item No.	Measuring range/mm	Pieces	Price RUB
906.564	0- 75	3	
906.565	0-100	4	
906.566	0-150	6	

Item No.	Measuring range/mm	Accuracy mm	Price RUB
906.556	0- 25	± 0.01	
906.557	25- 50	± 0.01	
906.558	50- 75	± 0.01	
906.559	75-100	± 0.01	
906.560	100-125	± 0.02	
906.561	125-150	± 0.02	
906.562	150-175	± 0.02	
906.563	175-200	± 0.02	

001.019 Technobearing 201 (RUB25)

Absolute digital micrometers with tolerance indication IP54

Digital calipers with function to set tolerance limits with clear optical Go (NoGo) reading.

- Measuring range: 0-100 mm.
- Resolution: 0.001 mm.
- mm/inch conversion.
- ABS/INC switchable.
- With data output.
- Adjustable tolerance limits.
- **Tolerance display** by means of illuminated green LED at GO value.
- On/off switch.
- Automatic switch-off.
- Reset.
- Tungsten carbide measuring faces: $\varnothing 6.5$ mm.
- Protection: IP54.
- DIN 863 T1.
- Power supply: 1 battery type CR2032.



USB interface:

- For data transfer to PC (e.g. Excel, Word).
- Operating system: Windows and other.
- PC connection: USB.
- No software or driver to install.
- Foot switch (optional).

NEW



Item No.	Measuring range/mm	Accuracy mm	Price RUB
906.862	0- 25	± 0.003	
906.863	25- 50	± 0.003	
906.864	50- 75	± 0.004	
906.865	75- 100	± 0.004	

Options:

495.157	Spare battery
906.618	USB interface
909.687	Footswitch for USB interface
910.038	Wireless USB receiver
906.619	Wireless transmitter

001.023 Technobearing 201 (9628)

Digital micrometers IP54

- Measuring range: 0-150 mm.
- Resolution: 0.001 mm.
- mm/inch conversion.
- Automatic switch-off.
- Reset.
- Tungsten carbide measuring faces: $\varnothing 6.5$ mm.
- Protection: IP54.
- DIN 863 T1.
- From measuring range 25 - 50 mm including setting gauge.
- Power supply: 1 battery type V357.



910.041



Sets

Item No.	Measuring range/mm	Pieces	Price RUB
910.053	0- 75	3	
910.054	0-100	4	
910.055	0-150	6	

Item No.	Measuring range/mm	Accuracy mm	Price RUB
910.041	0- 25	± 0.004	
910.042	25- 50	± 0.004	
910.043	50- 75	± 0.005	
910.044	75-100	± 0.005	
910.045	100-125	± 0.006	
910.046	125-150	± 0.006	
Option:			
836.535	Spare battery		

Digital micrometers IP65

These IP65 protected micrometers are especially suitable for use in production environments.

- Measuring range: 0-100 mm.
- Resolution: 0.001 mm.
- mm/inch conversion.
- ABS/INC switchable.
- On/off switch.
- Automatic switch-off.
- Reset.
- Tungsten carbide measuring faces: $\varnothing 6.5$ mm.
- Protection: IP65.
- From measuring range 25 - 50 mm including setting gauge.
- Delivery in a case with ball attachment and an inspection report.
- Power supply: 1 battery type CR2032.



909.988



TECHNOBEARING

Item No.	Measuring range/mm	Accuracy mm	Price RUB
909.988	0- 25	± 0.003	
909.989	25- 50	± 0.003	
909.990	50- 75	± 0.004	
909.991	75-100	± 0.004	
Option:			
495.157	Spare battery		

001.322 Technobearing 201 (9623)

Digital fast adjustable external measuring instruments IP65

These digital external measuring instruments have an IP65 classification and are therefore not only resistant to dust, but can also withstand water jets. The non-rotating spindle is lever operated and fast adjustable.

- Measuring range: 0-100 mm.
- Resolution: 0.001 mm.
- mm/inch conversion.
- ABS/INC switchable.
- Digimatic data output.
- On/off switch.
- Reset.
- Non-rotating spindle.
- Tungsten carbide measuring faces: $\varnothing 6.5$ mm.
- Protection: IP65.
- From measuring range 25 - 50 mm including setting gauge.
- Delivery in a case with ball attachment and an inspection report.
- Power supply: 1 battery type CR2032.

TECHNOBEARING



909.994

USB interface:

- For data transfer to PC (e.g. Excel, Word).
- Operating system: Windows and other.
- PC connection: USB.
- No software or driver to install.
- Foot switch (optional).



909.686



910.039/038



909.687



Item No.	Measuring range/mm	Accuracy mm	Price RUB
909.994	0- 25	± 0.003	
909.995	25- 50	± 0.003	
909.996	50- 75	± 0.004	
909.997	75 - 100	± 0.004	
With Bluetooth:			
910.075	0- 25	± 0.003	
Options:			
495.157	Spare battery		
909.686	USB interface		
909.687	Footswitch for USB interface		
910.038	Wireless USB receiver		
910.039	Wireless transmitter		

Digital micrometers IP65

These digital micrometers have an IP65 classification and are therefore not only resistant to dust but can also withstand water jets. Also available as fast adjustable micrometers with a pitch of 2 mm.

- Measuring range: 0-300 mm.
 - Resolution: 0.001 mm.
 - mm/inch conversion.
 - ABS/INC switchable.
 - On/off switch.
 - Automatic switch-off.
 - Tungsten carbide measuring faces: $\phi 6.5$ mm.
 - Protection: IP65.
 - DIN 863 T1.
 - From measuring range 25-50 mm including setting gauge.
 - Power supply: 1 battery type V357.
- Fast adjustable micrometers**
- 1 revolution of the thimble = 2 mm.



909.549

TECHNOBEARING



909.545

Item No.	Measuring range/mm	Accuracy mm	Price RUB
909.549	0- 25	± 0.002	
909.550	25- 50	± 0.002	
909.551	50- 75	± 0.003	
909.552	75-100	± 0.003	
909.556	100-125	± 0.003	
909.557	125-150	± 0.003	
909.558	150-175	± 0.004	
909.559	175-200	± 0.004	
909.560	200-225	± 0.004	
909.561	225-250	± 0.004	
909.562	250-275	± 0.005	
909.563	275-300	± 0.005	

Option:
836.535 Spare battery

Fast adjustable micrometers

Item No.	Measuring range/mm	Accuracy mm	Price RUB
909.545	0- 25	± 0.002	
909.546	25- 50	± 0.002	
909.547	50- 75	± 0.003	
909.548	75-100	± 0.003	

Sets

Item No.	Measuring range/mm	Pieces	Price RUB
909.577	0- 75	3	
909.578	0-100	4	
909.579	0-150	6	

PRICE

Micrometers

- Measuring range: 0-300 mm.
- Graduation: 0.01 mm.
- Friction thimble.
- Tungsten carbide measuring faces: $\varnothing 6.5$ mm.
- DIN 863 T1.
- From measuring range 25 - 50 mm including setting gauge.



Item No.	Measuring range/mm	Accuracy mm	Price RUB
906.000	0- 25	± 0.004	
906.001	25- 50	± 0.004	
906.002	50- 75	± 0.005	
906.003	75-100	± 0.005	
906.004	100-125	± 0.006	
906.005	125-150	± 0.006	
906.006	150-175	± 0.007	
906.007	175-200	± 0.007	
906.008	200-225	± 0.008	
906.009	225-250	± 0.008	
906.010	250-275	± 0.009	
906.011	275-300	± 0.009	

Model for left- and right-handed use:

907.167	0- 25	± 0.004	
907.168	25- 50	± 0.004	
907.169	50- 75	± 0.005	
907.170	75-100	± 0.005	

Sets

Item No.	Measuring range/mm	Price RUB
906.055	0- 75	
906.056	0-100	
906.057	0-150	
906.058	150-300	
906.059	0-300	



Micrometers 0.001 mm, parallax-free

Rugged micrometers with a vernier graduation of 0.001 mm and a favourable price-performance ratio.

- Measuring range: 0-200 mm.
- Vernier: 0.001 mm, parallax-free by enlarged thimble.
- Friction thimble.
- Tungsten carbide measuring faces: $\varnothing 6.5$ mm.
- DIN 863 T1.
- Delivery incl. adjustment tool.
- From measuring range 25 - 50 mm including setting gauge.



906.280



Item No.	Measuring range/mm	Accuracy mm	Price RUB
906.280	0- 25	± 0.004	
906.281	25- 50	± 0.004	
906.282	50- 75	± 0.005	
906.283	75-100	± 0.005	
906.284	100-125	± 0.006	
906.285	125-150	± 0.006	
906.286	150-175	± 0.007	
906.287	175-200	± 0.007	

Fast adjustable micrometers

Fast adjustable micrometers because one revolution results in a displacement of 1 mm. The measuring value can be read directly from the 100 step graduation on the thimble.

- Measuring range: 0-200 mm.
- Graduation: 0.01 mm.
- 1 revolution of the thimble = 1 mm.
- Thimble with 100 step graduation.
- Tungsten carbide measuring faces: $\varnothing 8$ mm.
- DIN 863 T1.
- From measuring range 25 - 50 mm including setting gauge.



907.000



Item No.	Measuring range/mm	Accuracy mm	Price RUB
907.000	0- 25	± 0.004	
907.001	25- 50	± 0.004	
907.002	50- 75	± 0.005	
907.003	75-100	± 0.005	
907.004	100-125	± 0.006	
907.005	125-150	± 0.006	
907.006	150-175	± 0.007	
907.007	175-200	± 0.007	

TECHNOBEARING

001.233. Technobearing 201 (9623)

Micrometers with a large measuring range

The varnished tubular frame is very stable and equipped with heat insulating grips. With two spacers for a large measuring span.

- Measuring range: 300 - 2000 mm.
- Measuring span:
 - 300 - 1000 mm: 100 mm (travel 25 mm, spacers 25 and 50 mm),
 - 1000 - 2000 mm: 200 mm (travel 50 mm, spacers 50 and 100 mm).
- Graduation: 0.01 mm.
- Rotating spindle.
- Tungsten carbide measuring faces: $\varnothing 8$ mm.
- No-glare chrome finished thimble.
- DIN 863 T3.
- With two setting gauges.

Item No.	Measuring range/mm	Accuracy mm	Price RUB
Measuring span 100 mm:			
906.012	300 - 400	± 0.011	
906.013	400 - 500	± 0.013	
906.014	500 - 600	± 0.015	
906.015	600 - 700	± 0.016	
906.016	700 - 800	± 0.018	
906.017	800 - 900	± 0.020	
906.018	900 - 1000	± 0.020	
Measuring span 200 mm:			
906.019	1000 - 1200	± 0.020	
906.020	1200 - 1400	± 0.024	
906.021	1400 - 1600	± 0.028	
906.022	1600 - 1800	± 0.031	
906.023	1800 - 2000	± 0.034	



Delivery ex Groningen, Netherlands

Micrometers with a large measuring range

Micrometers with a large measuring range, with very accurate, interchangeable anvils.

- Measuring range: 0-300 mm.
- Graduation: 0.01 mm.
- Tungsten carbide measuring faces: $\varnothing 6.35$ mm.
- Delivery incl. setting gauges and interchangeable anvils (increasing per 25 mm).



Item No.	Measuring range/mm	Accuracy mm	Number of anvils	Number of setting gauges	Price RUB
906.290	0 - 50	± 0.004	2	1	
906.294	0 - 100	± 0.005	4	3	
906.292	0 - 150	± 0.006	6	5	
906.291	50 - 100	± 0.005	2	2	
906.295	100 - 200	± 0.007	4	4	
906.293	150 - 300	± 0.009	6	6	
906.296	200 - 300	± 0.009	4	4	

Micrometers with adjustable anvil with dial indicator

Micrometers with an adjustable anvil with dial indicator, for measurements in a wide measuring range.

- Measuring range: 0-1000 mm.
- Graduation: 0.01 mm.
- Tungsten carbide measuring faces: $\varnothing 8$ mm.

Specifications dial indicator:

- Graduation: 0.01 mm.
- Range adjustable anvil: 5 mm.
- Max. measuring force anvil with dial indicator: 10 N.
- Adjustable tolerance markers.



Item No.	Measuring range/mm	Accuracy mm	Price RUB
907.015	0 - 100	± 0.006	
907.016	100 - 200	± 0.007	
907.017	200 - 300	± 0.008	
907.018	300 - 400	± 0.009	
907.019	400 - 500	± 0.010	
907.020	500 - 600	± 0.011	
907.021	600 - 700	± 0.012	
907.022	700 - 800	± 0.013	
907.023	800 - 900	± 0.014	
907.024	900 - 1000	± 0.015	

TECHNOBEARING

001.2319 Technobearing 201 (9623)

Digital micrometers IP65 with a large measuring range

- Measuring range: 0-1000 mm.
- Resolution: 0.001 mm.
- mm/inch conversion.
- ABS/INC switchable.
- Automatic switch-off.
- Reset/preset.
- Rotating spindle.
- Adjustable tolerance limits.
- Tungsten carbide measuring faces: $\varnothing 6.35$ mm.
- 0- 300 mm: cast iron frame, 300-1000 mm: tubular steel frame with insulating grips.
- Protection: IP65.
- Delivery in a case with setting gauges and interchangeable anvils.
- Power supply: 1 battery type V357.

TECHNOBEARING



Item No.	Measuring range/mm	Accuracy mm	Number of anvils	Number of setting gauges	Price RUB
909.580	0- 100	± 0.005	4	3	
909.581	100- 200	± 0.007	4	4	
909.582	200- 300	± 0.008	4	4	
909.583	300- 400	± 0.009	4	2	
909.584	400- 500	± 0.010	4	2	
909.585	500- 600	± 0.010	4	2	
909.586	600- 700	± 0.011	4	2	
909.587	700- 800	± 0.012	4	2	
909.588	800- 900	± 0.013	4	2	
909.589	900-1000	± 0.013	4	2	
Option:					
836.535	Spare battery				

001.207. Technobearing 201 (9628)

Micrometers with dial indicator

Micrometers with adjustable anvil and clamping shaft for a dial indicator. Especially suitable for Go/NoGo judgement and batch measurements.

- Measuring range: 0-175 mm.
- Graduation thimble and dial indicator: 0.01 mm.
- Range adjustable anvil: 8 mm.
- Trigger for (fast) adjustment.
- Tungsten carbide measuring faces: $\phi 6.5$ mm.
- Can also be used in combination with various other dial indicators with clamping stem $\phi 8$ mm.



907.008

TECHNOBEARING



Item No.	Measuring range/mm	Accuracy mm	Price RUB
907.008	0- 25	± 0.004	
907.009	25- 50	± 0.004	
907.010	50- 75	± 0.005	
907.011	75-100	± 0.005	
907.012	100-125	± 0.006	
907.013	125-150	± 0.006	
907.014	150-175	± 0.007	

Mini-micrometer

- Measuring range: 0-15 mm.
- Graduation: 0.01 mm.
- Measuring faces: $\phi 5$ mm.
- Without friction thimble.
- Dimensions: total length: 70 mm, throat depth: 14 mm.



Item No.	Measuring range/mm	Price RUB
906.180	0-15	

Micrometer with an extra large measuring range

The measuring range of this micrometer can be 'switched' from 25-50 to 0-25 mm by easy mounting of the prolonged anvil.

- Measuring range: 0-50 mm.
- Graduation: 0.01 mm.
- Accuracy: ± 0.004 mm.
- Tungsten carbide measuring faces: $\phi 6.5$ mm.
- Delivery incl. adjustment tool and prolonged anvil.



Item No.	Measuring range/mm	Accuracy mm	Price RUB
906.567	0-50	± 0.004	

Tolerance micrometers with precision dial indicator

Because of the retractable anvil, the fine adjustment and the tolerance markers very suitable for batch inspection and tolerance measurements.

- Measuring range: 0-100 mm.
- Measuring range dial indicator: ± 0.04 mm.
- Graduation (dial indicator): 0.001 mm.
- Accuracy:
micrometer: ± 0.003 mm (only 906.568),
dial indicator: ± 0.001 mm.
- Measuring force: 5-10 N (only 906.569/570/571/614).
- Adjustable tolerance markers.
- Tungsten carbide measuring faces:
906.568-599: $\varnothing 6.5$ mm,
906.569-614: $\varnothing 10$ mm.



Item No.	Measuring range/mm	Graduation mm	Vernier thimble/mm	Price RUB
906.568	0- 25	0.001	0.002	
906.597	25- 50	0.001	—	
906.598	50- 75	0.001	—	
906.599	75-100	0.001	—	
With protection IP54:				
906.569	0- 25	0.001	—	
906.570	25- 50	0.001	—	
906.571	50- 75	0.001	—	
906.614	75-100	0.001	—	

TECHNOBEARING

Tolerance micrometers with two spindles

Can be used as a Go/NoGo micrometer by setting of the lower and upper limits.

- Measuring range: 0-50 mm.
- Vernier: 0.002 mm.
- Accuracy: ± 0.003 mm.
- Tungsten carbide measuring faces: $\varnothing 6.5$ mm.



Item No.	Measuring range/mm	Accuracy mm	Price RUB
906.288	0-25	± 0.003	
906.289	25-50	± 0.003	

Snap gauges with dial indicator

Snap gauges with adjustable anvil and clamping shaft for a dial indicator. Especially suitable for Go/NoGo judgement and batch measurements.

- Measuring range: 0-300 mm.
- Measuring force: 6-9 N.
- Clamping shaft: $\varnothing 8$ mm (dial gauge not included).
- Travel of moving anvil: 3 mm.
- Anvil size: 14 x 11 mm.
- Chamfered anvils for easy insertion.
- For suitable dial indicators refer to the dial indicators elsewhere in this catalog.



Item No.	Measuring range/mm	Length/mm		Price RUB
		A	B	
906.237	0- 25	42	20	
906.238	25- 50	69	32.5	
906.239	50- 75	94	45	
906.240	75-100	119	57.5	
906.241	100-125	144	70	
906.242	125-150	169	82.5	
906.243	150-175	194	95	
906.244	175-200	219	107.5	
906.245	200-225	244	120	
906.246	225-250	269	132.5	
906.247	250-275	294	145	
906.248	275-300	319	157.5	

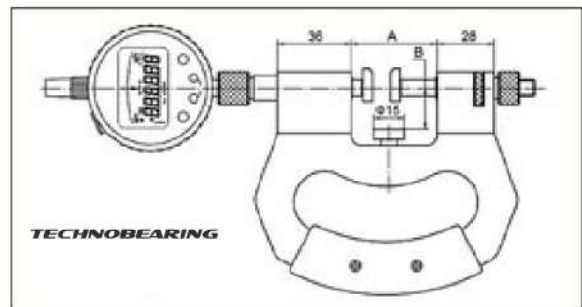

Digital vertical micrometers

Digital vertical micrometers for easy reading, for example, when measuring the thickness of metal or plastic sheet. These micrometers have an IP65 classification and are therefore not only resistant to dust but can also withstand water jets.

- Measuring range: 0-50 mm.
- Resolution: 0.001 mm.
- Accuracy: ± 0.002 mm.
- mm/inch conversion.
- ABS/INC switchable.
- On/off switch.
- Automatic switch-off.
- Tungsten carbide measuring faces: $\varnothing 6.5$ mm.
- Protection: IP65.
- Power supply: 1 battery type V357.



Item No.	Measuring range/mm	Price RUB
909.458	0-25	
909.459	25-50	
Option:		
836.535	Spare battery	

Micrometers with small measuring faces

For measuring hard-to-reach measuring points such as grooves.

- Measuring range: 0-175 mm.
- Analog: graduation 0.01 mm, digital: resolution 0.001 mm.
- Tungsten carbide measuring pins: $\varnothing 2 \times 5$ mm.

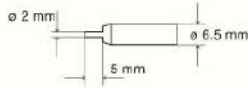

Digital

- mm/inch conversion.
- ABS/INC switchable.
- Reset/preset.
- Hold function.
- Preservation of the min/max value.
- Protection: IP65.
- Power supply: 1 battery type V357.



906.135

TECHNOBEARING



909.591

Analog

Item No.	Measuring range/mm	Accuracy mm	Price RUB
906.135	0- 25	± 0.004	
906.136	25- 50	± 0.004	
906.137	50- 75	± 0.005	
906.119	75- 100	± 0.005	
909.320	100- 125	± 0.006	
909.321	125- 150	± 0.006	
909.322	150- 175	± 0.007	

Digital

Item No.	Measuring range/mm	Accuracy mm	Price RUB
909.591	0- 25	± 0.002	
909.592	25- 50	± 0.002	
909.593	50- 75	± 0.003	
909.594	75- 100	± 0.003	
909.595	100- 125	± 0.003	
909.596	125- 150	± 0.003	
909.597	150- 175	± 0.004	

Option:
836.535 Spare battery



Micrometers with spherical anvil

Micrometers for measuring bent surfaces and wall thicknesses of tubes, bearings, rings, etc.

- Measuring range: 0-100 mm.
- Analog: graduation 0.01 mm, digital: resolution 0.001 mm.
- Tungsten carbide measuring faces: $\varnothing 6.5$ mm.

Digital

- mm/inch conversion.
- ABS/INC switchable.
- On/off switch.
- Automatic switch-off.
- Reset/preset.
- Protection: IP65.
- Power supply: 1 battery type V357.



906.155

TECHNOBEARING



909.598

Analog

Item No.	Measuring range/mm	Accuracy mm	Price RUB
906.155	0- 25	± 0.004	
907.044	25- 50	± 0.004	
907.045	50- 75	± 0.005	
907.046	75-100	± 0.005	

Digital

Item No.	Measuring range/mm	Accuracy mm	Price RUB
909.598	0- 25	± 0.002	
909.599	25- 50	± 0.002	
909.600	50- 75	± 0.003	
909.601	75-100	± 0.003	

Option:
836.535 Spare battery



Universal micrometers with interchangeable anvils

With these micrometers you are an all-rounder. The instruments have two interchangeable anvils, which gives them a lot of application possibilities. They can also be used as a height gauge, when the clamp for clamping the anvils is removed.

- Measuring range: 0-50 mm.
- Analog: graduation 0.01 mm, digital: resolution 0.001 mm.
- Accuracy: ±0.004 mm.
- Tungsten carbide measuring face: ø6.5 mm.
- Delivery incl. 2 tungsten carbide anvils.

Digital

- mm/inch conversion.
- ABS/INC switchable.
- On/off switch.
- Reset/preset.
- Adjustable tolerance limits (only 909.508).
- Protection: IP65.
- Power supply: 1 battery type V357.



906.190

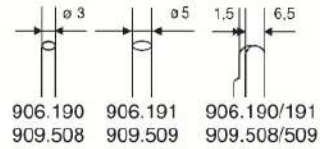

TECHNOBEARING



909.508

Analog

Item No.	Measuring range/mm	Price RUB
906.190	0-25	
906.191	25-50	

Digital

Item No.	Measuring range/mm	Price RUB
909.508	0-25	
909.509	25-50	
Option:		
836.535	Spare battery	



Digital micrometers IP65 with pin-shaped anvil

Digital micrometers for measuring e.g. (tube) wall thickness.

- Measuring range: 0-50 mm.
- Resolution: 0.001 mm.
- mm/inch conversion.
- ABS/INC switchable.
- Automatic switch-off.
- Reset/preset.
- Pin-shaped anvil: \varnothing 1.8 mm.
- Tungsten carbide measuring face: \varnothing 6.5 mm.
- Protection: IP65.
- Power supply: 1 battery type V357.



909.684



Item No.	Measuring range/mm	Accuracy mm	Price RUB
909.684	0 - 25	± 0.005	
909.685	25 - 50	± 0.005	
Option:			
836.535	Spare battery		

Digital micrometers with special measuring jaws

Digital micrometers with special measuring jaws for measurements in hard-to-reach places such as cut-outs in workpieces, gear pitches, etc.

- Measuring range: 0-200 mm.
- Resolution: 0.001 mm.
- mm/inch conversion.
- ABS/INC switchable.
- Automatic switch-off.
- Reset/preset.
- Non-rotating spindle.
- Power supply: 1 battery type V357.



909.676



Item No.	Measuring range/mm	Accuracy mm	Price RUB
909.676	0 - 25	± 0.006	
909.677	25 - 50	± 0.006	
909.678	50 - 75	± 0.007	
909.679	75 - 100	± 0.007	
909.680	100 - 125	± 0.009	
909.681	125 - 150	± 0.009	
909.682	150 - 175	± 0.010	
909.683	175 - 200	± 0.010	
Option:			
836.535	Spare battery		

TECHNOBEARING

001.217 Technobearing 201 (RUB)

Gear pitch micrometers

Micrometers with large, disk-shaped measuring faces for measuring e.g. gear pitches and paper and foil thickness.

- Measuring range: 0-200 mm.
- Analog: graduation 0.01 mm, digital: resolution 0.001 mm.
- Non-rotating spindle: $\varnothing 8$ mm.
- Measuring faces: stainless steel (HRC 52 - 54).

Digital

- mm/inch conversion.
- ABS/INC switchable.
- Automatic switch-off.
- Reset/preset.
- Power supply: 1 battery type V357.



906.580



909.777



TECHNOBEARING



Item No.	Measuring range/mm	Accuracy mm	Measuring faces \varnothing /mm	Price RUB
Analog:				
906.580	0- 25	± 0.006	20	
906.581	25- 50	± 0.006	20	
906.582	50- 75	± 0.007	20	
906.583	75-100	± 0.007	20	
906.584	100-125	± 0.009	30	
906.585	125-150	± 0.009	30	
906.586	150-175	± 0.010	30	
906.587	175-200	± 0.010	30	
Digital:				
909.777	0- 25	± 0.006	20	
909.778	25- 50	± 0.006	20	
909.779	50- 75	± 0.007	20	
909.780	75-100	± 0.007	20	
909.781	100-125	± 0.009	30	
909.782	125-150	± 0.009	30	
909.783	150-175	± 0.010	30	
909.784	175-200	± 0.010	30	
Option:				
836.535	Spare battery			

003.274 Technobearing 201 (9623)

Universal micrometers

Thanks to the seven interchangeable measuring inserts, which are available as an option, you are very flexible with these micrometers.

- Measuring range: 0-200 mm.
- Analog: graduation 0.01 mm, digital: resolution 0.001 mm.
- Non-rotating spindle.
- Insert shaft: $\varnothing 5$ mm.

Digital

- mm/inch conversion.
- ABS/INC switchable.
- On/off switch.
- Preset (except 909.785).
- Power supply: 1 battery type V357.



906.780



909.785

TECHNOBEARING

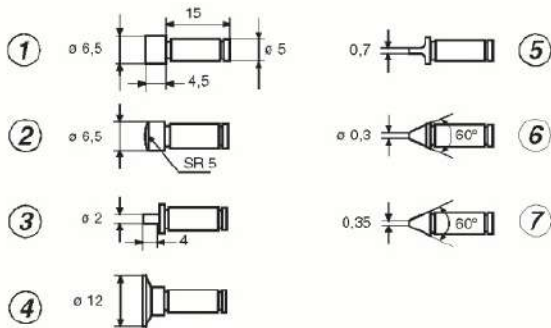

No.	Item No.	Description measuring faces	Price RUB
Measuring inserts, per pair:			
①	906.788	flat	
②	906.789	spherical	
③	906.790	small	
④	906.791	disc	
⑤	906.792	knife/flat	
⑥	906.793	point	
⑦	906.794	knife	
	906.795	Set of 7 pairs	

Item No.	Measuring range/mm	Accuracy mm	Price RUB
Analog, without measuring inserts:			
906.780	0- 25	± 0.004	
906.781	25- 50	± 0.004	
906.782	50- 75	± 0.005	
906.783	75-100	± 0.005	
906.784	100-125	± 0.008	
906.785	125-150	± 0.008	
906.786	150-175	± 0.009	
906.787	175-200	± 0.009	
Digital, without measuring inserts:			
909.785	0- 25	± 0.004	
909.786	25- 50	± 0.004	
909.787	50- 75	± 0.005	
909.788	75-100	± 0.005	
909.789	100-125	± 0.008	
909.790	125-150	± 0.008	
909.791	150-175	± 0.009	
909.792	175-200	± 0.009	
Option:			
836.535	Spare battery		



001.215 Technobearing 201 (RUB)

Deep throat micrometers

Micrometers with a deep throat especially for measuring the thickness of e.g. sheet metal, paper and plastic sheets.

- Measuring range: 0-50 mm.
- Analog: graduation 0.01 mm, digital: resolution 0.001 mm.
- Tungsten carbide measuring faces: $\varnothing 6.5$ mm.

Digital

- mm/inch conversion.
- ABS/INC switchable.
- Automatic switch-off.
- Reset/preset.
- Protection: IP65.
- Power supply: 1 battery type V357.



907.068



909.694



TECHNOBEARING

Item No.	Measuring range/mm	Accuracy mm	Throat depth/mm	Price RUB
Analog:				
907.068	0-25	± 0.004	50	
907.069	25-50	± 0.004	50	
907.070	0-25	± 0.005	100	
907.071	25-50	± 0.005	100	
907.072	0-25	± 0.006	150	
907.073	25-50	± 0.006	150	
Digital:				
909.694	0-25	± 0.004	50	
909.695	25-50	± 0.004	50	
909.696	0-25	± 0.005	100	
909.697	25-50	± 0.005	100	
909.698	0-25	± 0.006	150	
909.699	25-50	± 0.006	150	
Option:				
836.535	Spare battery			

003.276 Technobearing 201 (RUB25)

Brake disc micrometers

Micrometers especially for measuring the groove depth of brake discs.

- Measuring range: 7.6 - 50 mm.
- Analog: graduation 0.01 mm, digital: resolution 0.001 mm.
- Anvil with 60° point.
- Tungsten carbide measuring face: $\varnothing 6.5$ mm.
- Throat depth: 88 mm.

Digital

- mm/inch conversion.
- ABS/INC switchable.
- Automatic switch-off.
- Reset/preset.
- Protection: IP65.
- Power supply: 1 battery type V357.

TECHNOBEARING



907.056



909.793

Analog

Item No.	Measuring range/mm	Accuracy mm	Price RUB
907.056	7.6 - 33	± 0.004	
907.057	25 - 50	± 0.004	

Digital

Item No.	Measuring range/mm	Accuracy mm	Price RUB
909.793	7.6 - 33	± 0.004	
909.794	25 - 50	± 0.004	

Option:
836.535 Spare battery

Digital micrometers IP65 with large anvils

- Measuring range: 0 - 50 mm.
- Resolution: 0.001 mm.
- mm/inch conversion.
- ABS/INC switchable.
- On/off switch.
- On/reset switch.
- Tungsten carbide measuring face: $\varnothing 6.5$ mm.

- Anvil size:
909.488: 50 x 14 mm,
909.489: 60 x 14 mm.
- Protection: IP65.
- Power supply: 1 battery type V357.



909.488

Item No.	Measuring range/mm	Accuracy mm	Price RUB
909.488	0 - 25	± 0.004	
909.489	25 - 50	± 0.004	

Option:
836.535 Spare battery

Sheet metal micrometers

Micrometers especially for measuring the thickness of metal sheets, e.g. sheet metal. The large dial makes the reading very easy and quick.

- Measuring range: 0-25 mm.
- Graduation: 0.01 mm.
- Tungsten carbide measuring faces: $\varnothing 6.5$ mm.



Item No.	Measuring range/mm	Accuracy mm	Measuring faces	Price RUB
907.058	0-15	± 0.004	flat/flat	
907.059	0-25	± 0.004	flat/flat	
907.099	0-15	± 0.004	spherical/flat	
907.100	0-25	± 0.004	spherical/flat	

TECHNOBEARING

Micrometers with extra large measuring faces

Micrometers with extra large disk-shaped measuring faces for measurements of e.g. paper thickness and soft materials.

- Measuring range: 0-100 mm.
- Graduation: 0.01 mm.
- Non-rotating spindle.
- Tungsten carbide measuring faces: $\varnothing 60$ mm.



Item No.	Measuring range/mm	Accuracy mm	Price RUB
906.588	0- 25	± 0.008	
906.589	25- 50	± 0.008	
906.590	50- 75	± 0.010	
906.591	75-100	± 0.010	

Gear micrometers

Micrometers with ball-tipped measuring faces for measurements of straight and tapered external gears. Several measuring inserts optionally available.

- Measuring range: 0-175 mm.
- Analog: graduation 0.01 mm, digital: resolution 0.001 mm.
- Dimensions of anvil-tail: $\varnothing 5 \times 15$ mm.
- Tungsten carbide, ball-tipped measuring faces.

Digital

- mm/inch conversion.
- ABS/INC switchable.
- Automatic switch-off.
- Reset/preset.
- Protection: IP65.
- Power supply: 1 battery type V357.



907.081



909.859



TECHNOBEARING

Item No.	Ball \varnothing /mm	Module	Price RUB
Measuring inserts, per pair:			
907.088	1.0	0.6-0.65	
907.089	1.5	0.9-1.0	
907.090	2.0	1.25	
907.091	2.5	1.5	
907.092	3.0	1.75	
907.093	3.5	2	
907.094	4.0	2.25	
907.095	4.5	2.5	
907.096	5.0	2.75	
907.097	6.0	3.5	
907.098	Set 907.088-907.097		

Item No.	Measuring range/mm	Accuracy mm	Price RUB
Analog, without measuring inserts:			
907.081	0- 25	± 0.004	
907.082	25- 50	± 0.004	
907.083	50- 75	± 0.005	
907.084	75-100	± 0.005	
907.085	100-125	± 0.006	
907.086	125-150	± 0.006	
907.087	150-175	± 0.007	
Digital, without measuring inserts:			
909.859	0- 25	± 0.004	
909.860	25- 50	± 0.004	
909.861	50- 75	± 0.005	
909.862	75-100	± 0.005	
909.863	100-125	± 0.006	
909.864	125-150	± 0.006	
909.865	150-175	± 0.007	
Option:			
836.535	Spare battery		

003.271. Technobearing 201 (9623)

Micrometers with prism-shaped anvil

Analog and digital micrometers with prism-shaped anvil for measuring the diameters of objects with an odd number of flutes such as taps, reamers and mills. The angle of the prism aperture is designed for 3-, 5- or 7-fluted workpieces.

- Measuring range: 1 - 105 mm.
- Analog: graduation 0.01 mm, digital: resolution 0.001 mm.
- Spindle: $\varnothing 6.5$ mm.
- Tungsten carbide measuring faces. The 906.160 and 909.866 have a pointed spindle for the smallest objects.
- V-groove for:
 - 3-fluted objects: 60° ,
 - 5-fluted objects: 108° ,
 - 7-fluted objects: 128° .
- Delivery with a setting standard.

Digital

- mm/inch conversion.
- ABS/INC switchable.
- Automatic switch-off.
- Reset/preset.
- Protection: IP65.
- Power supply: 1 battery type V357.



Item No.	Measuring range/mm	Accuracy mm	Price RUB	Item No.	Price RUB
For 3-fluted objects (60°), analog:				Digital:	
906.160	1 - 15	± 0.004		909.866	
906.161	5 - 20	± 0.004		909.867	
906.162	20 - 35	± 0.005		909.868	
906.163	35 - 50	± 0.005		909.869	
906.164	50 - 65	± 0.006		909.870	
906.165	65 - 80	± 0.006		909.871	
907.060	80 - 95	± 0.007		909.872	
For 5-fluted objects (108°), analog:				Digital:	
906.166	5 - 25	± 0.004		909.873	
906.167	25 - 45	± 0.005		909.874	
906.168	45 - 65	± 0.006		909.875	
906.169	65 - 85	± 0.007		909.876	
907.061	85 - 105	± 0.008		909.877	
For 7-fluted objects (128°), analog:				Digital:	
906.170	5 - 25	± 0.004		909.878	
906.171	25 - 45	± 0.005		909.879	
906.172	45 - 65	± 0.006		909.880	
906.173	65 - 85	± 0.007		909.881	
Option:					
836.535	Spare battery				

TECHNOBEARING

Setting standards

Item No.	\varnothing mm	Price RUB
909.323	5	
909.324	20	
909.325	25	
909.326	35	
909.327	45	
909.328	50	
909.329	65	
909.330	80	
909.331	85	



909.326

001.233 Technobearing 201 (9625)

Micrometers with pointed measuring faces

- Measuring range: 0-100 mm.
- Analog: graduation 0.01 mm, digital: resolution 0.001 mm.

Digital

- mm/inch conversion.
- ABS/INC switchable.
- Preset.
- Protection: IP65.
- Power supply: 1 battery type V357.



906.145

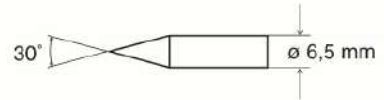

909.643

TECHNOBEARING

Analog

Item No.	Measuring range/mm	Accuracy mm	Price RUB
906.145	0 - 25	±0.004	
906.146	25 - 50	±0.004	
906.147	50 - 75	±0.005	
906.199	75 - 100	±0.005	

Digital

Item No.	Measuring range/mm	Accuracy mm	Price RUB
909.643	0 - 25	±0.004	
909.644	25 - 50	±0.004	
909.645	50 - 75	±0.005	
909.646	75 - 100	±0.005	

Option:
836.535 Spare battery

Micrometers with one pointed measuring face

- Measuring range: 0-50 mm.
- Graduation: 0.01 mm.

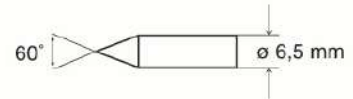

Item No.	Measuring range/mm	Accuracy mm	Price RUB
906.151	0 - 25	±0.004	
906.153	25 - 50	±0.004	

Micrometers with lamellar measuring faces

For measuring grooves, keyseats and other hard-to-reach places.

- Measuring range: 0-175 mm.
- Analog: graduation 0.01 mm, digital: resolution 0.001 mm.
- Non-rotating spindle.
- Blade width: 0.75 mm, blade length: 6 mm.

Digital

- mm/inch conversion.
- ABS/INC switchable.
- Reset/preset.
- Hold function.
- Power supply: 1 battery type V357.



906.141

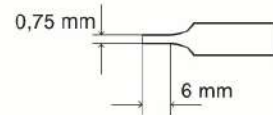

909.882

TECHNOBEARING

Analog

Item No.	Measuring range/mm	Accuracy mm	Price RUB
906.141	0- 25	±0.004	
906.142	25- 50	±0.004	
906.143	50- 75	±0.005	
906.144	75-100	±0.005	
906.222	100-125	±0.006	
906.223	125-150	±0.006	
906.224	150-175	±0.007	

Digital

Item No.	Measuring range/mm	Accuracy mm	Price RUB
909.882	0- 25	±0.004	
909.883	25- 50	±0.004	
909.884	50- 75	±0.005	
909.885	75-100	±0.005	
909.886	100-125	±0.006	
909.887	125-150	±0.006	
909.888	150-175	±0.007	

Option:
836.535 Spare battery



Screw thread micrometers

- Measuring range: 0-200 mm.
- Analog: graduation 0.01 mm, digital: resolution 0.001 mm.
- Insert shaft: $\varnothing 5$ mm.
- DIN 863 T3.
- Delivery incl. adjustment tools.
- From measuring range 25 - 50 mm including setting gauge 60°.
- No-glare chrome finished thimble.

Digital

- mm/inch conversion.
- ABS/INC switchable.
- On/off switch.
- Reset/preset.
- Protection: IP65.
- Power supply: 1 battery type V357.



Analog, without measuring inserts

Item No.	Measuring range/mm	Accuracy mm	Price RUB
906.750	0- 25	± 0.004	
906.751	25- 50	± 0.004	
906.752	50- 75	± 0.005	
906.753	75- 100	± 0.005	
906.754	100- 125	± 0.006	
906.755	125- 150	± 0.006	
906.756	150- 175	± 0.007	
906.757	175- 200	± 0.007	

Digital, without measuring inserts

Item No.	Measuring range/mm	Accuracy mm	Price RUB
909.889	0- 25	± 0.004	
909.890	25- 50	± 0.004	
909.891	50- 75	± 0.005	
909.892	75- 100	± 0.005	
909.893	100- 125	± 0.006	
909.894	125- 150	± 0.006	
909.895	150- 175	± 0.007	
909.896	175- 200	± 0.007	

Option:
836.535 Spare battery

PRICE

Screw thread micrometers (continued)



906.725

Item No.	Threads per inch	Price RUB
Measuring inserts for Whitworth threads, 55° flank angle, per pair:		
906.730	60 -48	
906.731	48 -40	
906.732	40 -32	
906.733	32 -24	
906.734	24 -18	
906.735	18 -14	
906.736	14 -10	
906.737	10 - 7.0	
906.738	7.0- 4.5	
906.739	4.5- 3.5	
906.740	Set 60-3.5	

Item No.	Pitch/mm	Price RUB
Measuring inserts for metric threads, 60° flank angle, per pair:		
906.720	0.4-0.5	
906.721	0.6-0.9	
906.722	1.0-1.75	
906.723	2.0-3.0	
906.724	3.5-5.0	
906.725	5.5-7.0	
906.726	Set 0.4-7.0	

Item No.	Threads per inch	Price RUB
Measuring inserts for UN, UNC and UNF threads, 60° flank angle, per pair:		
906.741	64 -48	
906.742	44 -28	
906.743	24 -14	
906.744	13 - 9	
906.745	8 - 5	
906.746	4.5- 3.5	
906.747	Set 64-3.5	

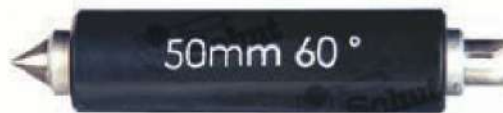

909.305

TECHNOBEARING

Item No.	Length/mm	Price RUB
Hardened steel setting standards for threads with 60° flank angle:		
909.304	25	
909.305	50	
909.306	75	
909.307	100	
909.308	125	
909.309	150	
909.310	175	
909.311	200	

Item No.	Length/mm	Price RUB
Hardened steel setting standards for threads with 55° flank angle:		
909.312	25	
909.313	50	
909.314	75	
909.315	100	
909.316	125	
909.317	150	
909.318	175	
909.319	200	

001.241. Technobearing 201 (9625)

Thread measuring wires

For measuring external threads using the three-wire method. The flank diameter can be determined according to the measured diameter, using tables.

- For micrometers with measuring faces $\phi 6.35$, $\phi 6.5$ or $\phi 8$ mm. (Also available for measuring faces $\phi 6.8$ and $\phi 7.5$ mm.)
- Very high measuring accuracy: ± 0.001 mm.
- In pairs or in a set.
- The wire holders are held in position on the anvil and spindle by a spring clamp.
- The wires are mounted on the holder in such a way that they position themselves on the thread.

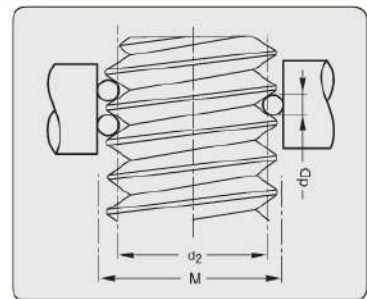

Thread measuring wires for micrometers with measuring faces $\phi 6.35$, $\phi 6.5$ or $\phi 8$ mm

$\phi 6.35$ mm		$\phi 6.5$ mm		$\phi 8$ mm		Wire diameter d_p /mm	Metric, pitch in mm	Whitworth, threads per inch	UN/UNC/UNF, threads per inch
Item No.	Price RUB	Item No.	Price RUB	Item No.	Price RUB				
833.442		779.161		836.689		0.17	0.25; 0.3	–	–
833.443		781.651		836.690		0.195	–	–	80
833.444		779.162		836.691		0.22	0.35	–	72
833.445		779.163		835.844		0.25	0.4	–	64
833.446		779.164		834.499		0.29	0.45; 0.5	–	56
833.447		779.165		834.498		0.335	0.6	40	48; 44
833.448		781.652		837.848		0.390	–	–	40
833.449		779.166		833.872		0.455	0.7-0.8	–	36
833.450		779.167		834.585		0.53	–	32; 28	32; 28
833.451		779.168		834.480		0.62	1	26; 24	24
833.452		779.169		834.586		0.725	1.25	22; 20; 19	20
833.453		779.170		834.290		0.895	1.5	18; 16	18; 16
833.454		779.171		834.502		1.10	1.75	14	14; 13
833.455		779.172		834.291		1.35	2	12; 11	12; 11
833.456		779.173		833.871		1.65	2.5	10; 9	10; 9
833.457		779.174		834.292		2.05	3.0; 3.5	8; 7	8; 7
833.458		779.175		834.416		2.55	4.0; 4.5	6	6
833.459		779.176		834.483		3.20	5.0; 5.5	5; 4.5	5; 4.5
837.501		837.642		834.509		4.00	6.0	4; 3.5	4
834.580		779.160		834.581		Set with wire diameters 0.17 to 3.20 mm			

Hub micrometers

Micrometers with a shallow bracket for measuring the thickness bearing bushes, bore shoulders and other hard-to-reach places.

- Measuring range: 0-100 mm.
- Graduation: 0.01 mm.
- Tungsten carbide measuring faces: $\phi 6.5$ mm.
- Varnished frame.
- Throat depth: 10.2 mm.
- Throat height: 21.2 mm (907.133: 18.7 mm).



907.133

Item No.	Measuring range/mm	Accuracy mm	Price RUB
907.133	0- 25	± 0.004	
907.134	25- 50	± 0.004	
907.135	50- 75	± 0.004	
907.136	75-100	± 0.005	

TECHNOBEARING



Can seam micrometer

Micrometer especially for measuring the depth and thickness of e.g. the seams of steel cans.

- Measuring range: 0-13 mm.
- Graduation: 0.01 mm.
- Accuracy: ± 0.004 mm.
- Tungsten carbide measuring faces: $\phi 5$ mm.



Item No.	Measuring range/mm	Price RUB
907.175	0-13	



Wire and ball micrometer

- Measuring range: 0-10 mm.
- Graduation: 0.01 mm.
- Accuracy: ± 0.004 mm.
- Tungsten carbide measuring faces: $\phi 6.5$ mm.



Item No.	Measuring range/mm	Price RUB
906.175	0-10	



001.236 Technobearing 201 (9625)

Setting gauges

Cylindrical gauges for micrometers with flat parallel measuring faces.

- Measuring faces $L < 100$ mm: $\varnothing 7$ mm, flat,
 $L < 300$ mm: $\varnothing 8$ mm, flat,
 $L \geq 300$ mm: $\varnothing 8$ mm, spherical.
- With plastic insulating grip.
- Larger sizes available on request.



907.464

PRICE

Item No.	Length mm	Accuracy μm	Price RUB
907.464	25	± 2	
907.465	50	± 2	
907.466	75	± 2.5	
907.467	100	± 2.5	
907.468	125	± 3	
907.469	150	± 3	
907.470	175	± 3.5	
907.471	200	± 4	
907.472	225	± 4	
907.473	250	± 4	
907.474	275	± 4.5	
907.475	300	± 4.5	
907.476	325	± 5	
907.477	350	± 5	
907.478	375	± 5.5	
907.479	400	± 5.5	
907.480	425	± 6	
907.481	450	± 6	
907.482	475	± 6.5	
907.483	500	± 6.5	
907.484	525	± 7	
907.485	575	± 7.5	
907.486	625	± 7.5	
907.487	675	± 8	
907.488	725	± 8.5	
907.489	775	± 9.5	
907.490	825	± 10	
907.491	875	± 10.5	
907.492	925	± 11	
907.493	975	± 11.5	
907.494	1050	± 12	
907.495	1150	± 13	
907.496	1250	± 14	
907.497	1350	± 15	
907.498	1450	± 16	
909.529	1550	± 17	
909.530	1650	± 18	
909.531	1750	± 19	
909.532	1850	± 20	
909.533	1950	± 21	

Setting standards

Cylindrical setting standards for micrometers with prism-shaped anvil.



909.326

TECHNOBEARING

PRICE

Item No.	Diameter/mm	Price RUB
909.323	5	
909.324	20	
909.325	25	
909.326	35	
909.327	45	
909.328	50	
909.329	65	
909.330	80	
909.331	85	

Setting standards

Hardened steel setting standards for threads with 55° or 60° flank angle.

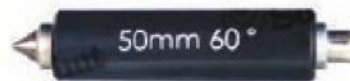

909.305

PRICE

Item No.	Length/mm	Price RUB
For threads with 60° flank angle:		
909.304	25	
909.305	50	
909.306	75	
909.307	100	
909.308	125	
909.309	150	
909.310	175	
909.311	200	
For threads with 55° flank angle:		
909.312	25	
909.313	50	
909.314	75	
909.315	100	
909.316	125	
909.317	150	
909.318	175	
909.319	200	

Micrometer stand

Rigid table stand for micrometers.

- Inclination adjustable.
- Weight: 1.1 kg.



Item No.	Clamping range/mm	Price RUB
906.212	0 - 18	

Micrometer stand

Cast steel stand for micrometers.

- Fixed inclination: 45°.
- Weight: 0.7 kg.



Item No.	Clamping range/mm	Price RUB
908.983	4 - 12	

Foldable micrometer stand

Portable stand with a folded structure for micrometers.



Item No.	Clamping range/mm	Price RUB
907.152	7 - 14	



TECHNOBEARING

Ball attachments

These ball attachments can be clamped on any anvil and spindle with a diameter of 6.5 or 8 mm.

- Ball: \varnothing 5 mm.



Item No.	Description	Price RUB
907.150	Ball attachment, \varnothing 6.5 mm	
907.166	Ball attachment, \varnothing 8 mm	

Measuring force indicators

Within the range of 5 to 12 N these measuring force indicators can show the measuring force of micrometers.



Item No.	For micrometers	Price RUB
907.151	0 - 25 mm	
908.947	25 - 50 mm	
908.948	50 - 75 mm	
908.949	75 - 100 mm	

Probe set for micrometers

These attachments can be clamped on any anvil and spindle with a diameter of 6.5 mm. The set consists of a point-shaped, knife-edged, blade-shaped, disk-shaped, ball-shaped probe and one with a small and one with a very small measuring face.

- Delivery in a case.



Item No.	Description	Price RUB
909.118	Probe set for micrometers	

Micrometer inspection sets

For the inspection of micrometers according DIN 863. Suitable for micrometers with a measuring range up to 25 mm.

- Nominal sizes (mm):
2.5 - 5.1 - 7.7 - 10.3 - 12.9 - 15.0 - 17.6 - 20.2 - 22.8 - 25.0.
- Including plan parallel optical flat $\phi 30 \times 12$ mm.



Item No.	Material	Grade	Price RUB
909.346	steel	1	
909.345	steel	0	
909.162	ceramic	1	
909.340	ceramic	0	

909.340

Thread and tolerance tables

Thread table

Table with all standard international thread indications: metric, Ww, Gas, BSF, Pg, BA, UNC, UNF and UNEF.

Tolerance table

Table comprising all tolerances and fits according ISO R286, up to 500 mm (table with over 6400 pairs of tolerance values for internal and external measurements).

Conversion table mm/inch

For converting from mm to inch and from inch to mm.



Item No.	Description	Price RUB
835.162	Thread table	
835.163	Tolerance table	
835.164	Conversion table mm/inch	

001.216 Technobearing 201 (04623)

Micrometer head with counter

Micrometer head with an easy read-out at 0.01 mm by means of the counter mechanism.

- Measuring range: 0-25 mm.
- Resolution: 0.01 mm.
- Accuracy: ±0.003 mm.
- Numerical counter adjustable.
- Rotating spindle: ϕ 6.5 mm.
- Tungsten carbide measuring face.
- Delivery with adjustment tool.



TECHNOBEARING

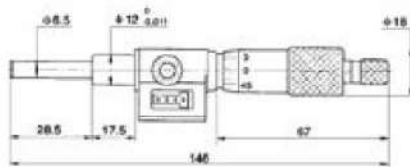

Item No.	Measuring range/mm	Spindle ϕ /mm	Price RUB
906.543	0-25	6.5	

Micrometer heads

- Measuring range: 0-25 mm.
- Graduation: 0.01 mm or vernier 0.002 mm.



906.072

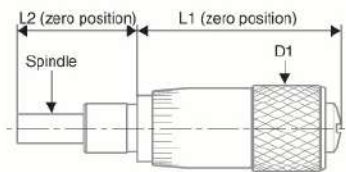

906.070

Item No.	Measuring range/mm	Graduation mm	Accuracy mm	Spindle ϕ /mm	Dimensions/mm clamping	D1	L1	L2	Price RUB
Without friction thimble, steel measuring face:									
906.070	0- 6.5	0.01	±0.005	3.5 (flat)	ϕ 6 x 6	ϕ 10	23	14	
906.074	0- 6.5	0.01	±0.005	3.5 (spherical)	ϕ 6 x 6	ϕ 10	23	14	
906.071	0- 13	0.01	±0.004	5.0 (flat)	ϕ 9.5 x 9.5	ϕ 14	33	26	
Friction thimble with spring click in measuring thimble, tungsten carbide measuring face:									
906.072	0- 25	0.01	±0.003	6.5 (flat)	ϕ 12 x 17	ϕ 19	65	46	
906.073	0- 25	0.002	±0.003	6.5 (flat)	ϕ 12 x 17	ϕ 19	65	46	

Digital micrometer heads

Several digital micrometer heads with different possibilities.

- Measuring range: 0-50 mm.
- Resolution: 0.001 mm.
- Accuracy: ±0.003 mm (909.900/901: ±0.005 mm).
- mm/inch conversion.
- ABS/INC switchable.
- On/off switch.
- Automatic switch-off.
- Memory absolute measuring value.
- Preset for ABS measurement.
- Friction thimble.
- Power supply: 1 battery type V357.

TECHNOBEARING

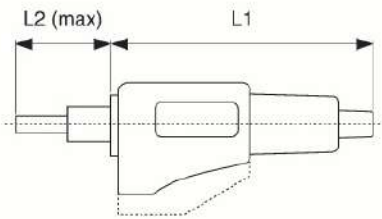

Item No.	Measuring range/mm	Dimensions/mm spindle clamping	L1	L2	Description measuring faces	Price RUB
With IP65 protection:						
909.897	0-25	ø6.5 ø12 x 17.5	115	46	flat, tungsten carbide measuring face	
909.898	0-25	ø6.5 ø12 x 17.5	115	46	spherical	
909.899	0-25	ø6.5 ø12 x 17.5	116	56	flat, non-rotating tip	
909.900	0-50	ø7.5 ø12 x 35.5	140	89	flat, tungsten carbide measuring face	
909.901	0-50	ø7.5 ø12 x 35.5	140	89	spherical	
With non-rotating spindle:						
909.902	0-25	ø7.5 ø12 x 10	124	39	flat, tungsten carbide measuring face	
909.903	0-25	ø7.5 ø12 x 10	123	39	interchangeable measuring inserts	
906.297	0-25	ø6.5 ø12 x 17.5	98	48	tungsten carbide measuring face	
906.298	0-25	ø8 ø12 x 20	98	50	tungsten carbide measuring face	
Option:						
836.535	Spare battery					

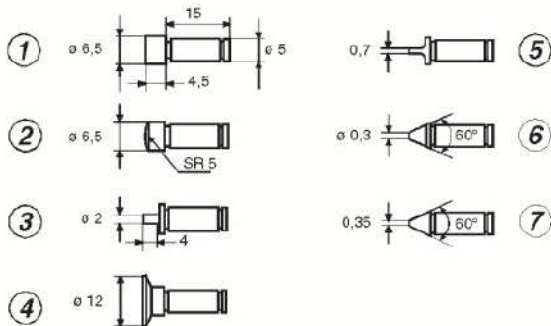

No.	Item No.	Description measuring faces	Price RUB
Measuring inserts, per pair:			
①	906.788	flat	
②	906.789	spherical	
③	906.790	small	
④	906.791	disc	
⑤	906.792	knife/flat	
⑥	906.793	point	
⑦	906.794	knife	
	906.795	Set of 7 pairs	

001.317 Technobearing 2019 (RUB)

Internal micrometers / Internal & external measuring instruments

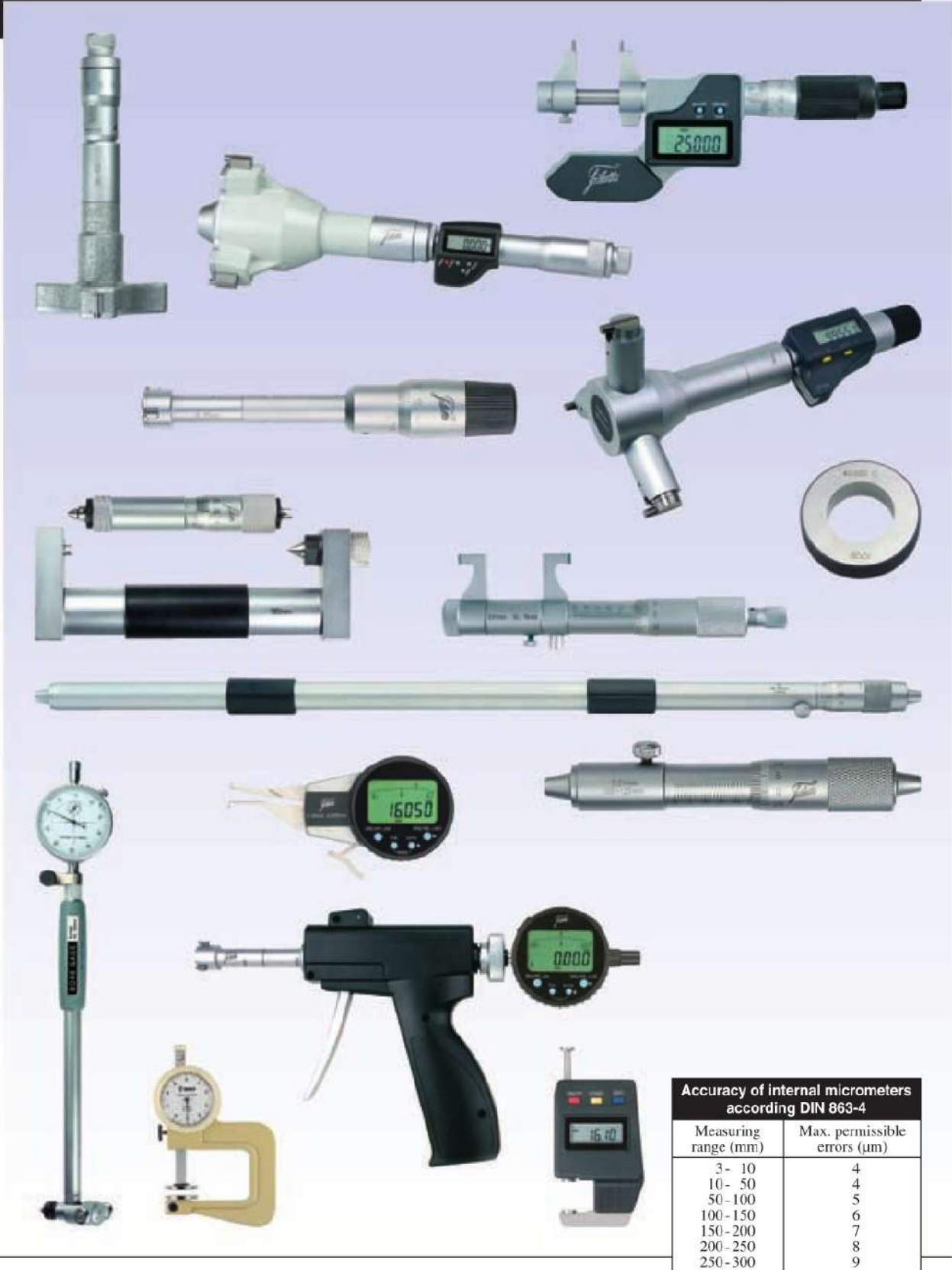

DOK.001. Technobearing 201 (REV2)

Three-point internal micrometers

Three-point internal micrometers for quick and accurate measurement of internal dimensions, within a large measuring range.

- Measuring range: $\varnothing 3.5 - 300$ mm.
- Graduation: 0.001 mm ($\varnothing 3.5 - 12$ mm),
0.005 mm ($\varnothing 12 - 300$ mm).
- Self-centering.
- Tungsten carbide measuring faces.
- Sets are delivered incl. setting rings and extension (836.730 without extension).
- Setting rings are conform to factory standard.
- Delivery in a case.



836.708



836.718



836.745

TECHNOBEARING



Measuring head
(measuring range)
 $\varnothing 3.5 - 50$ mm



$\varnothing 50 - 100$ mm



$\varnothing 100 - 300$ mm



$\varnothing 100 - 300$ mm

16 mm



Three-point internal micrometers (continued)

Item No.	Measuring range/mm	Accuracy mm	Length L/mm	Length A/mm	Price RUB
836.700	∅ 3.5- 4	±0.005	19	1.5	
836.701	∅ 4.0- 4.5	±0.005	19	1.5	
836.702	∅ 4.5- 5.5	±0.005	19	1.5	
836.703	∅ 5.5- 6.5	±0.005	19	1.5	
836.704	∅ 6 - 8	±0.005	52	1.5	
836.705	∅ 8 - 10	±0.005	52	1.5	
836.706	∅ 10 - 12	±0.005	52	1.5	
836.707	∅ 12 - 16	±0.005	71	1.5	
836.708	∅ 16 - 20	±0.005	71	1.5	
836.709	∅ 20 - 25	±0.005	82	1.5	
836.710	∅ 25 - 30	±0.005	82	1.5	
836.711	∅ 30 - 35	±0.005	84	1.5	
836.712	∅ 35 - 40	±0.005	84	1.5	
836.713	∅ 40 - 50	±0.006	100	1.5	
836.714	∅ 50 - 60	±0.006	100	1.5	
836.715	∅ 60 - 70	±0.006	100	1.5	
836.716	∅ 70 - 80	±0.006	100	1.5	
836.717	∅ 80 - 90	±0.006	100	1.5	
836.718	∅ 90 -100	±0.006	100	1.5	
836.719	∅100 -125	±0.008	110	16	
836.720	∅125 -150	±0.008	110	16	
836.721	∅150 -175	±0.008	110	16	
836.722	∅175 -200	±0.008	110	16	
836.723	∅200 -225	±0.012	110	16	
836.724	∅225 -250	±0.012	110	16	
836.725	∅250 -275	±0.012	110	16	
836.726	∅275 -300	±0.012	110	16	

TECHNOBEARING

Extensions

Item No.	Extension mm	For measuring range/mm	Price RUB
836.780	100	∅ 6- 12	
836.782	150	∅12- 20	
836.784	150	∅20- 40	
836.786	150	∅40-100	

Sets

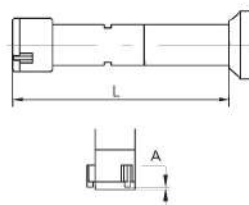

Item No.	Measuring range/mm	Setting rings mm	Extension mm	Number of instruments	Price RUB
836.730*	∅ 3.5- 6.5	∅4, 5.5	—	4	
836.735	∅ 6 - 12	∅8, 10	100	3	
836.740	∅12 - 20	∅16	150	2	
836.745	∅20 - 40	∅25, 35	150	4	
836.750	∅40 -100	∅50, 70, 90	150	6	

* Without extension.



Three-point internal micrometers

Three-point internal micrometers, with factory measuring report, for accurately measuring (blind) bores.

- Measuring range: \varnothing 6-300 mm.
- Self-centering.
- Tungsten carbide measuring faces (measuring range \varnothing 6-12 mm: hardened steel).
- Separate instruments within measuring range \varnothing 6-100 mm and the sets are delivered incl. setting ring(s) and extension.
- Setting rings are conform to factory standard.
- To \varnothing 100 mm: implementation for blind bores. From \varnothing 100 mm: implementation for through holes or blind bores.
- DIN 863: to \varnothing 100 mm.
- Delivery in a case, with an inspection report.

Analog

- Graduation: 0.001 mm (\varnothing 6- 12 mm), 0.005 mm (\varnothing 12-300 mm).

Digital

- Resolution: 0.001 mm.
- mm/inch conversion.
- On/off switch.
- Reset.
- Preset.
- Hold function.
- Protection: IP54.
- Power supply: 1 battery type V357.



909.811

NEW



909.832



Measuring head (measuring range) \varnothing 6-50 mm



\varnothing 50- 100 mm



\varnothing 100- 175 mm



\varnothing 175-300 mm



For blind bores



For through holes

TECHNOBEARING



COA.316 Technobearing 2019 04623

Three-point internal micrometers (continued)

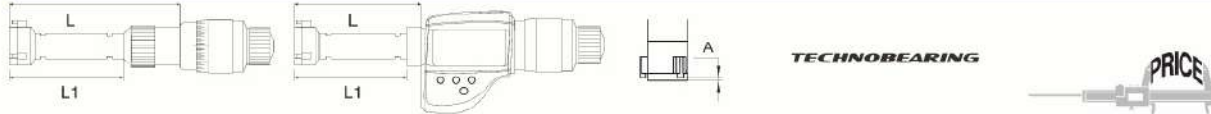

Item No.	Price RUB	Item No.	Price RUB	Measuring range/mm	Accuracy mm	L/mm	Length L/mm	A/mm
Analog (blind bores):		Digital (blind bores):				Analog:	Digital:	
909.807		909.828		∅ 6- 8	±0.004	L1 L	L1 L	
909.808		909.829		∅ 8- 10	±0.004	27 -	43 -	1
909.809		909.830		∅ 10- 12	±0.004	50 -	43 -	1
909.810		909.831		∅ 12- 16	±0.004	50 -	45 -	0.4
909.811		909.832		∅ 16- 20	±0.004	50 -	45 -	0.4
909.812		909.833		∅ 20- 25	±0.004	- 80	53 -	0.4
909.813		909.834		∅ 25- 30	±0.004	- 80	53 -	0.4
909.814		909.835		∅ 30- 40	±0.004	- 90	- 80	0.4
909.815		909.836		∅ 40- 50	±0.005	- 90	- 80	0.4
909.816		909.837		∅ 50- 63	±0.005	- 100	- 80	0.5
909.817		909.838		∅ 62- 75	±0.005	- 100	- 80	0.5
909.818		909.839		∅ 75- 88	±0.005	- 100	- 80	0.5
909.819		909.840		∅ 87- 100	±0.005	- 100	- 80	0.5
910.150		910.158		∅ 100- 125	±0.008	- 140	- 140	0.5
910.151		910.159		∅ 125- 150	±0.008	- 140	- 140	0.5
910.152		910.160		∅ 150- 175	±0.008	- 140	- 140	0.5
910.153		910.161		∅ 175- 200	±0.008	- 140	- 140	0.5
910.154		910.162		∅ 200- 225	±0.008	- 140	- 140	0.5
910.155		910.163		∅ 225- 250	±0.008	- 140	- 140	0.5
910.156		910.164		∅ 250- 275	±0.008	- 140	- 140	0.5
910.157		910.165		∅ 275- 300	±0.008	- 140	- 140	0.5
Analog (through holes):		Digital (through holes):				Analog:	Digital:	
909.820		909.841		∅ 100- 125	±0.008	L1 L	L1 L	
909.821		909.842		∅ 125- 150	±0.008	- 140	- 140	20
909.822		909.843		∅ 150- 175	±0.008	- 140	- 140	20
909.823		909.844		∅ 175- 200	±0.008	- 140	- 140	20
909.824		909.845		∅ 200- 225	±0.008	- 140	- 140	20
909.825		909.846		∅ 225- 250	±0.008	- 140	- 140	20
909.826		909.847		∅ 250- 275	±0.008	- 140	- 140	20
909.827		909.848		∅ 275- 300	±0.008	- 140	- 140	20

Sets

Item No.	Price RUB	Item No.	Price RUB	Measuring range/mm	Setting rings ∅/mm	Extension mm	Number of instruments
Analog:		Digital:					
909.849		909.853		∅ 6- 12	8, 10	50	3
909.850		909.854		∅ 12- 20	16	100	2
909.851		909.855		∅ 20- 50	25, 40	150	4
909.852		909.856		∅ 50- 100	62, 87	150	4

Options

Item No.	Description	Price RUB
836.535	Spare battery	
For meas. range ∅ 100 - 300 mm:		
909.857	Extension with length 150 mm	

NEW



909.850

001.023 Technobearing 201 (9628)

Three-point internal micrometers

Three-point internal micrometers for accurately measuring (blind) bores.

- Measuring range: $\varnothing 6 - 300$ mm.
- Graduation: 0.001 mm ($\varnothing 6 - 12$ mm),
0.005 mm ($\varnothing 12 - 300$ mm).
- Self-centering.
- Tungsten carbide measuring faces.
- Interchangeable measuring bolts from measuring range $\varnothing 100 - 125$ mm.
- Delivery in a case, incl. extension 150 mm (measuring range $\varnothing 6 - 12$ mm: 100 mm).
- Separate instruments within measuring range $\varnothing 6 - 100$ mm and the sets are delivered incl. setting ring(s).
- Setting rings are conform to factory standard.

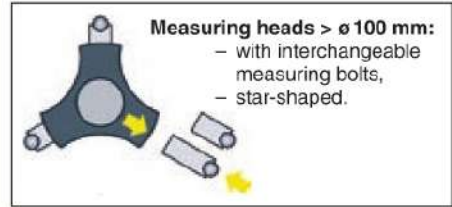

TECHNOBEARING



908.654



908.662



Measuring head
(measuring range)
 $\varnothing 6 - 50$ mm



$\varnothing 50 - 100$ mm



$\varnothing 100 - 300$ mm



For blind bores



COA 203
Technobearing 201 (94623)

Three-point internal micrometers (continued)



TECHNOBEARING

908.672

PRICE

Per piece

Item No.	Measuring range/mm	Setting ring ϕ /mm	Accuracy mm	Length L/mm	Length A/mm	Price RUB
908.650	ϕ 6- 8	6	± 0.004	54.5	0.7	
908.651	ϕ 8- 10	8	± 0.004	54.5	0.7	
908.652	ϕ 10- 12	10	± 0.004	54.5	0.7	
908.653	ϕ 12- 16	16	± 0.004	80	0.7	
908.654	ϕ 16- 20	16	± 0.004	80	0.7	
908.655	ϕ 20- 25	25	± 0.004	90	0.7	
908.656	ϕ 25- 30	25	± 0.004	90	0.7	
908.657	ϕ 30- 40	40	± 0.004	97	0.7	
908.658	ϕ 40- 50	40	± 0.005	97	0.7	
908.659	ϕ 50- 63	62	± 0.005	114	0.7	
908.660	ϕ 62- 75	62	± 0.005	114	0.7	
908.661	ϕ 75- 88	87	± 0.005	114	0.7	
908.662	ϕ 87-100	87	± 0.005	114	0.7	
908.663	ϕ 100-125	-	± 0.005	145	0.7	
908.664	ϕ 125-150	-	± 0.005	145	0.7	
908.665	ϕ 150-175	-	± 0.005	145	0.7	
908.666	ϕ 175-200	-	± 0.005	145	0.7	
908.667	ϕ 200-225	-	± 0.007	145	0.7	
908.668	ϕ 225-250	-	± 0.007	145	0.7	
908.669	ϕ 250-275	-	± 0.007	145	0.7	
908.670	ϕ 275-300	-	± 0.007	145	0.7	

Sets

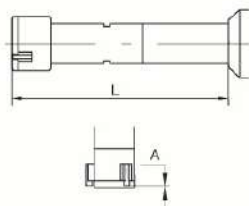

Item No.	Measuring range/mm	Setting rings ϕ /mm	Extension mm	Number of instruments	Price RUB
908.671	ϕ 6- 12	6, 8, 10	100	3	
908.672	ϕ 12- 20	16	150	2	
908.673	ϕ 20- 50	25, 40	150	4	
908.674	ϕ 50-100	62, 87	150	4	

Digital three-point internal micrometers IP65

Digital three-point internal micrometers with a resolution of 0.001 mm for accurately measuring (blind) bores. These micrometers have several functions, and combined with the accurate read-out this results in a favourable price-performance ratio.

- Measuring range: $\varnothing 6-300$ mm.
- Resolution: 0.001 mm.
- mm/inch conversion.
- ABS/INC switchable.
- On/off switch.
- Automatic switch-off.
- Reset/preset.
- Self-centering.
- Tungsten carbide measuring faces.
- Complete measuring range without changing the measuring bolts.
- Protection: IP65.
- Delivery in a case, incl. extension 150 mm (measuring range $\varnothing 6-12$ mm: 100 mm).
- Separate instruments within measuring range $\varnothing 6-100$ mm and the sets are delivered incl. setting ring(s) (conforms to factory standard).
- Power supply: 1 battery type V357.



910.125



910.119

TECHNOBEARING



Measuring head
(measuring range)
 $\varnothing 6-50$ mm



$\varnothing 50-100$ mm



$\varnothing 100-300$ mm



For blind bores



Digital three-point internal micrometers IP65 (continued)

NEW



TECHNOBEARING

PRICE

Per piece

Item No.	Measuring range/mm	Setting ring ϕ /mm	Accuracy mm	Length L/mm	Length A/mm	Price RUB
910.113	ϕ 6- 8	6	± 0.004	54.5	0.7	
910.114	ϕ 8- 10	8	± 0.004	54.5	0.7	
910.115	ϕ 10- 12	10	± 0.004	54.5	0.7	
910.116	ϕ 12- 16	16	± 0.004	80	0.7	
910.117	ϕ 16- 20	16	± 0.004	80	0.7	
910.118	ϕ 20- 25	25	± 0.004	90	0.7	
910.119	ϕ 25- 30	25	± 0.004	90	0.7	
910.120	ϕ 30- 40	40	± 0.004	97	0.7	
910.121	ϕ 40- 50	40	± 0.005	97	0.7	
910.122	ϕ 50- 63	62	± 0.005	114	0.7	
910.123	ϕ 62- 75	62	± 0.005	114	0.7	
910.124	ϕ 75- 88	87	± 0.005	114	0.7	
910.125	ϕ 87-100	87	± 0.005	114	0.7	
910.126	ϕ 100-125	100	± 0.005	150	0.7	
910.127	ϕ 125-150	150	± 0.005	150	0.7	
910.128	ϕ 150-175	150	± 0.005	150	0.7	
910.129	ϕ 175-200	200	± 0.005	150	0.7	
910.130	ϕ 200-225	200	± 0.007	150	0.7	
910.131	ϕ 225-250	250	± 0.007	150	0.7	
910.132	ϕ 250-275	250	± 0.007	150	0.7	
910.133	ϕ 275-300	275	± 0.007	150	0.7	

Option:

836.535 Spare battery

Sets

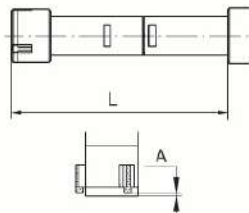

Item No.	Measuring range/mm	Setting rings ϕ /mm	Extension mm	Number of instruments	Price RUB
910.134	ϕ 6- 12	6, 8, 10	100	3	
910.135	ϕ 12- 20	16	150	2	
910.136	ϕ 20- 50	25, 40	150	4	
910.137	ϕ 50-100	62, 87	150	4	

Digital three-point internal micrometers

Digital three-point internal micrometers with a resolution of 0.001 mm for accurately measuring (blind) bores. These micrometers have several functions, and combined with the accurate read-out this results in a favourable price-performance ratio.

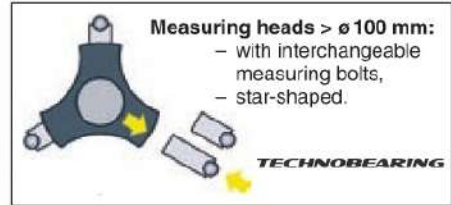

- Measuring range: ϕ 6-300 mm.
- Resolution: 0.001 mm.
- mm/inch conversion.
- ABS/INC switchable.
- On/off switch.
- Automatic switch-off.
- Reset/preset.
- Self-centering.
- Tungsten carbide measuring faces.
- Interchangeable measuring bolts from measuring range ϕ 100-125 mm.
- Protection: IP54.
- Delivery in a case, incl. extension 150 mm (measuring range ϕ 6-12 mm: 100 mm).
- Separate instruments within measuring range ϕ 6-100 mm and the sets are delivered incl. setting ring(s) (conforms to factory standard).
- Power supply: 1 battery type V357.



Item No.	Measuring range/mm	Setting ring ϕ /mm	Accuracy mm	Length L/mm	Length A/mm	Price RUB
906.886	ϕ 6- 8	6	± 0.004	54.5	0.7	
906.887	ϕ 8- 10	8	± 0.004	54.5	0.7	
906.888	ϕ 10- 12	10	± 0.004	54.5	0.7	
906.889	ϕ 12- 16	16	± 0.004	80	0.7	
906.890	ϕ 16- 20	16	± 0.004	80	0.7	
906.891	ϕ 20- 25	25	± 0.004	90	0.7	
906.892	ϕ 25- 30	25	± 0.004	90	0.7	
906.893	ϕ 30- 40	40	± 0.004	97	0.7	
906.894	ϕ 40- 50	40	± 0.005	97	0.7	
906.895	ϕ 50- 63	62	± 0.005	114	0.7	
906.896	ϕ 62- 75	62	± 0.005	114	0.7	
906.897	ϕ 75- 88	87	± 0.005	114	0.7	
906.898	ϕ 87-100	87	± 0.005	114	0.7	
906.899	ϕ 100-125	-	± 0.005	145	0.7	
908.675	ϕ 125-150	-	± 0.005	145	0.7	
908.676	ϕ 150-175	-	± 0.005	145	0.7	
908.677	ϕ 175-200	-	± 0.005	145	0.7	
908.678	ϕ 200-225	-	± 0.007	145	0.7	
908.679	ϕ 225-250	-	± 0.007	145	0.7	
908.680	ϕ 250-275	-	± 0.007	145	0.7	
908.681	ϕ 275-300	-	± 0.007	145	0.7	

Option:
836.535 Spare battery

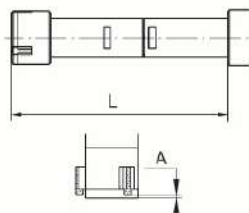

Item No.	Measuring range/mm	Setting rings ϕ /mm	Extension mm	Number of instruments	Price RUB
906.900	ϕ 6- 12	6, 8, 10	100	3	
906.901	ϕ 12- 20	16	150	2	
906.902	ϕ 20- 50	25, 40	150	4	
906.903	ϕ 50-100	62, 87	150	4	

001.271. Technobearing 201 (9623)

Digital three-point internal micrometers

Digital three-point internal micrometers with a large measuring range. With optional extensions also for measuring in deep (blind) bores.

- Measuring range: $\varnothing 50-300$ mm.
- Max. measuring depth: 1100 mm.
- Resolution: 0.001 mm.
- mm/inch conversion.
- ABS/INC switchable.
- On/off switch.
- Automatic switch-off.
- Reset/preset.
- Self-centering.
- Tungsten carbide measuring faces.
- Protection: IP54.
- Delivery in a case, incl. extension 150 mm.
- Separate instruments within measuring range $\varnothing 50-100$ mm and the sets are delivered incl. setting ring(s).
- Setting rings are conform to factory standard.
- Power supply: 1 battery type V357.

TECHNOBEARING



906.906

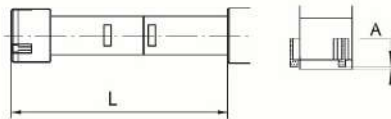

Extensions

Item No.	Extension mm	Price RUB
906.227	150	
906.228	500	
906.229	1000	



Item No.	Measuring range/mm	Setting ring \varnothing /mm	Accuracy mm	Length L/mm	Length A/mm	Price RUB
906.904	$\varnothing 50-70$	50	± 0.004	107	0.5	
906.905	$\varnothing 70-100$	70	± 0.004	107	0.5	
906.906	$\varnothing 100-150$	-	± 0.005	107	0.5	
906.907	$\varnothing 150-250$	-	± 0.007	107	0.5	
906.908	$\varnothing 200-300$	-	± 0.007	107	0.5	

Item No.	Measuring range/mm	Setting ring \varnothing /mm	Number of instruments	Price RUB
906.909	$\varnothing 50-100$	70	2	
906.910	$\varnothing 100-250$	150	2	

Option

Item No.	Description	Price RUB
836.535	Spare battery	

COIL 278 Technobearing 201 (RUB28)

Digital three-point internal micrometers up to 1000 mm

Digital three-point internal micrometers with a large measuring range. With optional extensions also for measuring in deep bores.

- Measuring range: \varnothing 200 - 1000 mm.
- Resolution: 0.001 mm.
- mm/inch conversion.
- ABS/INC switchable.
- On/off switch.
- Automatic switch-off.
- Reset/preset.
- Self-centering.
- Tungsten carbide measuring faces.
- Protection: IP54.
- Delivered incl. setting ring.
- Power supply: 1 battery type V357.



907.787

With interchangeable measuring bolts

The measuring range is extra large because of the interchangeable measuring bolts. The high accuracy of the measuring bolts enables exchanging without recalibrating the read-out.

- Max. measuring depth:
907.787: 750 mm,
907.788: 1750 mm.
- Accuracy:
 $\pm(1+0.02L) \mu\text{m}$ (L in mm).
- Delivery in a case, incl. extensions and setting ring.

TECHNOBEARING



Item No.	Measuring range/mm	Setting ring \varnothing /mm	Length L/mm	Length A/mm	Extensions mm	Price RUB
907.787	\varnothing 200 - 500	200	105	0.5	150, 500	
907.788	\varnothing 200 - 1000	200	105	0.5	150, 500, 1000	

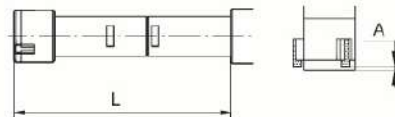

Option

Item No.	Description	Price RUB
836.535	Spare battery	

Extensions

Item No.	Extension mm	Price RUB
906.227	150	
906.228	500	
906.229	1000	

004_030 Technobearing 201 (06/23)

Three-point internal micrometers

Three-point internal micrometers with a clever pistol-shaped base instrument for quick, easy and accurate measurements of internal measures such as (blind) bores. Easy single handed operation for both right and left handed use. Available as single instruments and as sets, with setting ring(s) and extension.

- Measuring range: ϕ 6-100 mm.
- Measuring depth: 0-270 mm.
- Read-out depends on the type of dial indicator or measuring probe.
- Clamping shaft: ϕ 8 mm.
- Self-centering.
- Excl. dial indicator or measuring probe.
- Tungsten carbide measuring faces.
- Setting rings are conform to factory standard.
- Delivery in a case.



Separate instruments

Item No.	Measuring range/mm	Accuracy mm ¹	Setting ring ϕ /mm	Extension mm	Length/mm		Price RUB
					L	A	
907.770	ϕ 6- 8	\pm 0.004	8	100	50	2	
907.771	ϕ 8- 10	\pm 0.004	8	100	50	2	
907.772	ϕ 10- 12	\pm 0.004	10	100	50	2	
907.773	ϕ 12- 16	\pm 0.004	16	150	65	0.5	
907.774	ϕ 16- 20	\pm 0.004	16	150	65	0.5	
907.775	ϕ 20- 25	\pm 0.004	25	150	91	0.5	
907.776	ϕ 25- 30	\pm 0.004	25	150	91	0.5	
907.777	ϕ 30- 40	\pm 0.004	40	150	97	0.5	
907.778	ϕ 40- 50	\pm 0.005	40	150	97	0.5	
907.779	ϕ 50- 63	\pm 0.005	62	150	112	0.5	
907.780	ϕ 62- 75	\pm 0.005	62	150	112	0.5	
907.781	ϕ 75- 88	\pm 0.005	87	150	112	0.5	
907.782	ϕ 87-100	\pm 0.005	87	150	112	0.5	

¹ Excl. accuracy of dial indicator or measuring probe.

Sets

Item No.	Measuring range/mm	Setting ring(s) ϕ /mm	Number of pistol grips	Extension mm	Price RUB
907.783	ϕ 6- 12	8, 10	1	100	
907.784	ϕ 12- 20	16	1	150	
907.785	ϕ 20- 50	25, 40	2	150	
907.786	ϕ 50-100	62, 87	1	150	

Internal measuring instruments

- Measuring range: 6-450 mm.
- Read-out depends on the type of dial indicator.
- Incl. standard dial indicator 0-3 mm/0.01 mm.
- Clamping shaft: $\varnothing 8$ mm.
- Self-centering (except 907.230).
- Interchangeable measuring inserts with tungsten carbide stylus tip (907.230 with spherical measuring face).
- Also suitable for various dial indicators from e.g. Mitutoyo, TESA, Käfer and Peacock with clamping stem $\varnothing 8$ mm.



Item No.	Measuring range/mm	Measuring depth/mm	Price RUB
907.230	6- 10	40	
907.231	10- 18	100	
907.232	18- 35	125	
907.233	35- 50	150	
907.235	50-160	150	
907.236	160-250	400	
907.237	250-450	400	



907.235 + 907.933



TECHNOBEARING

Optional dial indicators

Item No.	Measuring range/mm	Read-out mm	Accuracy mm	Price RUB
Analog:				
907.933	0-10	0.01	-	
Digital (with determination of the reversal point):				
909.250	0-12.5	0.002	± 0.015	
909.251	0-12.5	0.001	± 0.006	
910.004	0-12.7	0.001	± 0.004	



COA_3D3 Technobearing 201 (9623)

Peacock internal measuring instruments

- Measuring range: 6-400 mm.
- Read-out depends on the type of dial indicator.
- Clamping shaft: $\varnothing 8$ mm.
- Self-centering.
- Interchangeable measuring inserts with tungsten carbide stylus tip.
- Also suitable for various dial indicators from e.g. Mitutoyo, TESA and Käfer with clamping stem $\varnothing 8$ mm.



855.160

TECHNOBEARING



855.507

Item No.	Measuring range/mm	Measuring depth/mm	Price RUB
855.010	6 - 10	50	
855.018	10 - 18	100	
855.035	18 - 35	150	
855.060	35 - 60	150	
855.150	50 - 150	150	
855.160	100 - 160	250	
855.250	160 - 250	250	
855.260	250 - 400	400	
Option:			
855.507	Peacock dial indicator 0-10 mm, graduation 0.01 mm		

Setting instrument for internal measuring instruments

This instrument offers you the best way to accurately zero-set your internal measuring instruments with dial indicator. Gauge blocks are used to set the exact reference value. The special receiver assures that the centering device of the micrometer also functions when in use on this instrument, making the checking just as easy as measuring.

- Adjustment range: 18 - 400 mm.
- The setting instrument consists of a stand with double guidance and a flat measuring jaw.
- Excl. gauge blocks.
- Delivery in a case.



Item No.	Adjustment range/mm	Price RUB
907.877	18 - 400	

Setting gauges for inside micrometers

Used for setting of inside micrometers.

- Measuring range: 0 - 275 mm.



910.005



Item No.	Length mm	Accuracy mm	Parallelism mm	Price RUB
910.005	50	±0.003	0.003	
910.006	75	±0.004	0.004	
910.007	100	±0.005	0.005	
910.008	150	±0.005	0.005	
910.009	200	±0.005	0.005	
910.010	250	±0.005	0.005	
910.011	275	±0.005	0.005	

TECHNOBEARING

COI 220 Technobearing 201 04625

Stick micrometers

- Measuring range: 50-600 mm.
- Graduation: 0.01 mm.
- Locking screw (except 906.078).
- Spherical tungsten carbide measuring faces: $\varnothing 8 \times 8$ mm (906.078/079: $\varnothing 9 \times 2.5$ mm).
- With insulating grips (only 906.083 - 906.099).
- Excl. setting gauge.



906.080



906.096

TECHNOBEARING



Item No.	Measuring range/mm	Accuracy mm	Price RUB
906.078	50- 75	±0.006	
906.079	75-100	±0.006	
906.080	100-125	±0.006	
906.081	125-150	±0.008	
906.082	150-175	±0.008	
906.083	175-200	±0.008	
906.084	200-225	±0.009	
906.085	225-250	±0.009	
906.086	250-275	±0.009	
906.087	275-300	±0.009	
906.088	300-325	±0.009	

Item No.	Measuring range/mm	Accuracy mm	Price RUB
906.089	325-350	±0.009	
906.090	350-375	±0.010	
906.091	375-400	±0.010	
906.092	400-425	±0.010	
906.093	425-450	±0.010	
906.094	450-475	±0.011	
906.095	475-500	±0.011	
906.096	500-525	±0.011	
906.097	525-550	±0.011	
906.098	550-575	±0.011	
906.099	575-600	±0.011	

Stick micrometer sets

- Measuring range: 50-5000 mm.
- Measuring range micrometer:
 906.911-906.917: 50- 63 mm,
 906.918: 150- 175 mm,
 906.919-906.923: 1000-1050 mm.
- Graduation: 0.01 mm.
- Accuracy:
 906.911-906.918: $\pm(3+n+L/50)$ μm ,
 906.919-906.923: $\pm(7+n+L/50)$ μm
 (n = number of extensions,
 L = max. measuring length in mm).
- Locking screw.
- Spherical tungsten carbide measuring faces.
- With insulating grips
 (only 906.918-906.923).
- External diameter micrometer/extensions:
 906.911-906.917: 15.5 mm,
 906.918: 22 mm,
 906.919-906.923: 28 mm.
- Incl. setting gauge
 (only 906.911-917: 50 mm,
 906.918: 150 mm).
- Delivery in a case.

TECHNOBEARING



906.918

Item No.	Measuring range/mm	Number of extensions	Price RUB
906.911*	50- 63	–	
906.912	50- 100	2	
906.913	50- 150	3	
906.914	50- 300	5	
906.915	50- 500	6	
906.916	50-1000	8	
906.917	50-1500	10	
906.918	150-2000	9	
906.919*	1000-1050	–	
906.920	1000-2000	5	
906.921	1000-3000	6	
906.922	1000-4000	7	
906.923	1000-5000	8	



* Single instrument (without extensions).

Digital stick micrometer sets

- Measuring range: 150-2000 mm.
- Measuring range micrometer: 150-175 mm.
- Resolution: 0.001 mm.
- Locking screw.
- Spherical tungsten carbide measuring faces.
- With insulating grips
 (only 906.797-906.799).
- External diameter micrometer/extensions:
 22 mm.
- Incl. setting gauge: 150 mm.
- Delivery in a case.



906.796

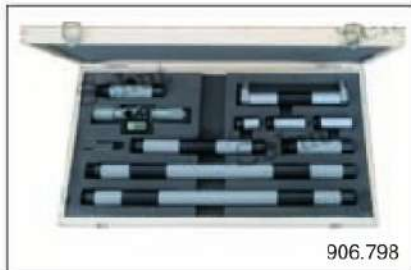

906.798

Item No.	Measuring range/mm	Number of extensions	Accuracy μm	Price RUB
906.796*	150- 175	–	6.5	
906.797	150-1000	6	29	
906.798	150-1500	8	41	
906.799	150-2000	9	52	

* Single instrument (without extensions).



Inside micrometers with interchangeable anvils

Screw thread micrometers for internal measurements of pitch diameters. The interchangeable anvils allow measurements of several kinds of screw thread.

- Measuring range: 75 - 300 mm.
- Graduation: 0.01 mm.
- Insert shaft: $\phi 5$ mm.
- Delivery incl. setting gauge for metric thread, 60° flank angle.



Item No.	Measuring range/mm	Accuracy mm	Price RUB
Inside micrometers without inserts:			
906.924	75 - 100	± 0.025	
906.925	100 - 125	± 0.028	
906.926	125 - 150	± 0.030	
906.927	150 - 175	± 0.033	
906.928	175 - 200	± 0.035	
906.929	200 - 225	± 0.038	
906.930	225 - 250	± 0.040	
906.931	250 - 275	± 0.043	
906.932	275 - 300	± 0.045	

Item No.	Threads per inch	Price RUB
Inserts for Whitworth threads, 55° flank angle, per pair:		
906.940	60 - 48	
906.941	48 - 40	
906.942	40 - 32	
906.944	32 - 24	
906.945	24 - 18	
906.946	18 - 14	
906.947	14 - 10	
906.948	10 - 7	
906.949	7 - 4.5	
906.950	4.5 - 3.5	
906.951	Set 60 - 3.5	

Item No.	Pitch/mm	Price RUB
Inserts for metric threads, 60° flank angle, per pair:		
906.933	0.4 - 0.5	
906.934	0.6 - 0.9	
906.935	1 - 1.75	
906.936	2 - 3	
906.937	3.5 - 5	
906.938	5.5 - 7	
906.939	Set 0.4 - 7	

Item No.	Threads per inch	Price RUB
Inserts for UN, UNC and UNF threads, 60° flank angle, per pair:		
906.952	64 - 48	
906.953	44 - 28	
906.954	24 - 14	
906.955	13 - 9	
906.956	8 - 5	
906.957	4.5 - 3.5	
906.958	Set 64 - 3.5	

Internal micrometers

Internal micrometers with special measuring jaws for measurements in hard-to-reach places.

- Measuring range: 5 - 200 mm.
- Analog: graduation 0.01 mm, digital: resolution 0.001 mm.
- Tungsten carbide cylindrical measuring faces.
- Internal micrometers within measuring range 5 - 50 mm are delivered incl. setting ring.
- Delivery in a case.

Analog

- No-glare chrome finished design.

Digital

- mm/inch conversion.
- ABS/INC switchable.
- Automatic switch-off.
- Reset/preset.
- Power supply: 1 battery type V357.



906.509



909.974

TECHNOBEARING

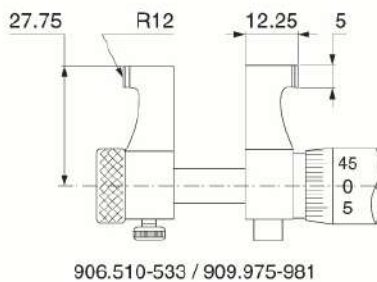
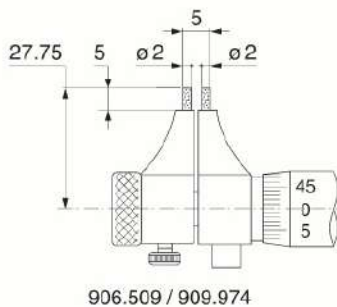

906.510-533 / 909.975-981



Item No.	Measuring range/mm	Accuracy mm	Price RUB
Analog:			
906.509	5- 30	±0.005	
906.510	25- 50	±0.006	
906.511	50- 75	±0.007	
906.512	75-100	±0.008	
906.530	100-125	±0.009	
906.531	125-150	±0.009	
906.532	150-175	±0.010	
906.533	175-200	±0.010	
Digital:			
909.974	5- 30	±0.005	
909.975	25- 50	±0.006	
909.976	50- 75	±0.007	
909.977	75-100	±0.008	
909.978	100-125	±0.009	
909.979	125-150	±0.009	
909.980	150-175	±0.010	
909.981	175-200	±0.010	
Option:			
836.535	Spare battery		

COIL 274, Technobearing 201 (9623)

Groove micrometers

Micrometers for measuring e.g. steps in bores and internal cross grooves. With double graduation for internal and external measurements. By means of the disk-shaped measuring faces the wide, depth and location of grooves in bores can be determined.

- Measuring range:
external measuring: 0 - 100 mm,
internal measuring: 1.6- 101.5 mm.
- Graduation: 0.01 mm.
- Accuracy: ± 0.01 mm.
- Diameter measuring faces:
907.137: 6.5 mm,
907.138-907.141: 13 mm.
- Double graduation.

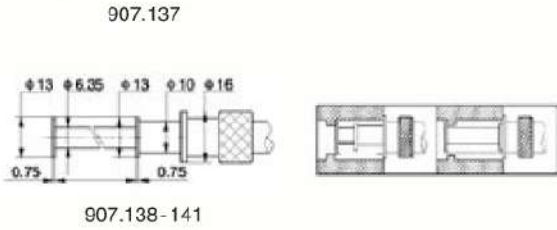
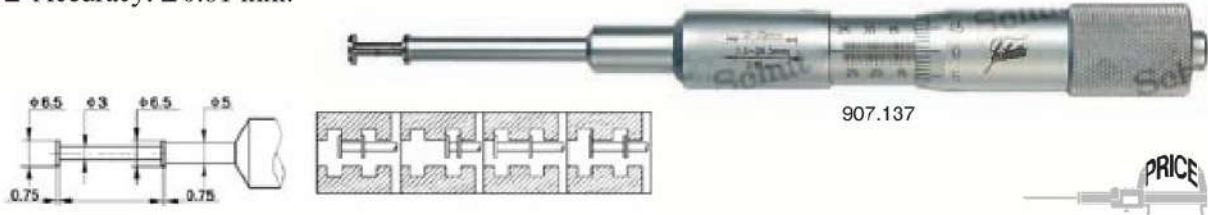

Item No.	Ext. measuring range/mm	Int. measuring range/mm	Price RUB
907.137	0- 25	1.6- 26.5	
907.138	0- 25	1.6- 26.5	
907.139	25- 50	26.5- 51.5	
907.140	50- 75	51.5- 76.5	
907.141	75-100	76.5- 101.5	

Two-point internal measuring instruments

- Measuring range: 20- 150 mm.
- Graduation: 0.01 mm.
- Interchangeable measuring inserts.
- Delivery in a case with an measuring inserts.



Item No.	Measuring range/mm	A _{max} mm	C _{min} mm	D _{max} mm	Price RUB
855.501	20- 34	60	2	3	
855.502	30- 60	75	2.5	5	
855.503	55- 150	90	4	9	

Diatest crankshaft meters

- Measuring range: 45-500 mm.
- Graduation: 0.01 mm.
- Rotatable dial.

- Delivery with dial indicator, counter-weight and extensions in a case.



Item No.	Measuring range/mm	Price RUB
831.469	45-150	
831.470	60-300	
831.471	60-500	
Options:		
831.472	Separate dial indicator for 831.469	
831.473	Counterweight for 831.469	
831.474	Separate dial indicator for 831.470 and 831.471	
831.475	Counterweight for 831.470 and 831.471	

TECHNOBEARING

Crankshaft meters

- Measuring range: 60-500 mm.
- Graduation: 0.01 mm.
- Rotatable dial.
- Delivery with dial indicator, counter-weight and extensions in a case.



907.919



907.917

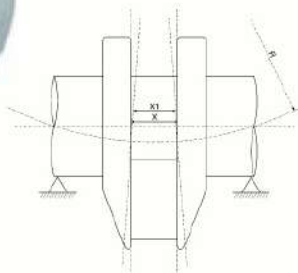

Item No.	Measuring range/mm	Price RUB
907.918	60-300	
907.919	60-500	
Option:		
907.917	Separate dial indicator	

COI.229 Technobearing 201 (9623)

Telescopic gauges

In places that are hard to reach with standard measuring instruments, you can use these telescopic gauges. The spring gauge is put into the bore, centers itself, after that you can turn on the locking screw. Then the gauge is pulled out and you can measure the result, for instance with a micrometer.

- Measuring range: 8-150 mm.
- Chrome finished.

TECHNOBEARING

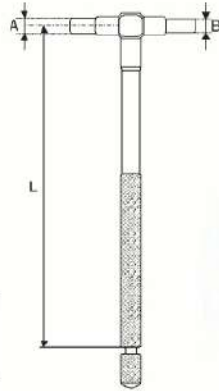

Individual gauges

Item No.	Measuring range/mm	Dimensions/mm			Price RUB
		L	A	B	
906.604	8 - 12.7	102	4	3	
906.605	12.7- 19	102	5	4	
906.606	19 - 32	102	5	4	
906.607	32 - 54	127	7.5	6	
906.608	54 - 90	127	7.5	6	
906.609	90 - 150	127	7.5	6	

Set of gauges

Item No.	Measuring range/mm	Price RUB
906.610	8 - 150	

Plug gauges for small bores (blind/through)

Ideal for measuring of small bores (blind and through) and grooves. The spring gauge is put into the bore, centers itself, after that you can turn on the locking screw. Then the gauge is pulled out and you can measure the result, for instance with a micrometer. Separate set for blind bores and through bores.

- Measuring range: 3-13 mm (4 gauges: 3-5 mm, 5-7.5 mm, 7.5-10 mm and 10-13 mm).
- Chrome finished.



907.747



907.748

Set of gauges

Item No.	Description	Price RUB
907.747	For blind bores	
907.748	For through bores	

Digital internal measuring instrument

- Measuring range: 12.7-170 mm.
- Resolution: 0.1 mm.
- Accuracy: ± 0.2 mm.
- mm/inch conversion.
- On/off switch.
- Automatic switch-off.
- Reset.
- Hold function.
- Locking screw.
- Power supply: 1 battery type CR2032.

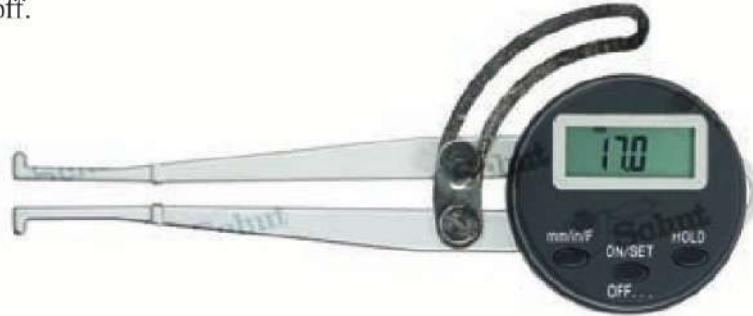

TECHNOBEARING

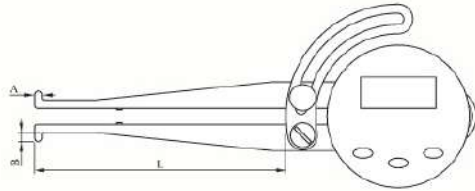

Item No.	Measuring range/mm	Length/mm			Price RUB
		L	A	B	
909.409	12.7 - 170	85	3	3	
Option: 495.157 Spare battery					

Digital external measuring instrument

- Measuring range: 0-160 mm.
- Resolution: 0.1 mm.
- Accuracy: ± 0.2 mm.
- mm/inch conversion.
- On/off switch.
- Automatic switch-off.
- Reset.
- Hold function.
- Locking screw.
- Power supply: 1 battery type CR2032.



PRICE

Item No.	Measuring range/mm	Length/mm			Price RUB
		L	A	B	
909.408	0 - 160	85	3	25	
Option: 495.157 Spare battery					

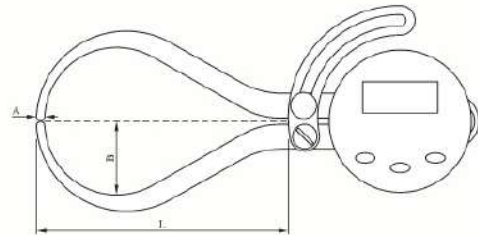

004.314.
Technobearing 201 (9623)

Digital internal measuring instruments

Digital internal measuring instruments for measurements of bores, internal grooves and other hard-to-reach places.

- Measuring range: 5 - 60 mm.
- Resolution: 0.005 mm. Digital-analog display changes automatically between 0.01, 0.02 and 0.05 mm (± 20 scale divisions).
- mm/inch conversion.
- ABS/INC switchable.
- Large LCD display, 340° rotatable.
- On/off switch.
- Automatic switch-off.
- Reset/preset.
- Hold and min/max functions.
- Adjustable tolerance limits.
- Measuring faces with different contact forms.
- Power supply: 1 battery type CR2032.



Item No.	Measuring range/mm	Accuracy mm	Length/mm			Contact form/mm	Price RUB
			L	A	B		
Travel 10 mm:							
908.810	5-15	± 0.02	20	1	1.5	① R 0.3	
908.811	10-20	± 0.02	25	1.5	3.0	① R 0.3	
908.812	20-30	± 0.02	30	2	6.5	① R 0.5	
908.813	30-40	± 0.02	30	2.5	9.0	① R 0.5	
908.814	40-50	± 0.02	30	2.5	9.0	① R 0.5	
908.816	10-20	± 0.02	25	1.5	3.0	② $\phi 1.5$	
908.817	20-30	± 0.02	30	2	6.5	② $\phi 1.5$	
908.818	30-40	± 0.02	30	2.5	9.0	② $\phi 1.5$	
908.819	40-50	± 0.02	30	2.5	9.0	② $\phi 1.5$	
Travel 20 mm:							
908.820	5-25	± 0.03	35	1	1.5	① R 0.3	
908.821	10-30	± 0.03	55	2	3.5	① R 0.5	
908.822	20-40	± 0.03	80	3	6.5	① R 0.5	
908.823	30-50	± 0.03	80	3	8.5	① R 0.5	
908.824	40-60	± 0.03	80	3	8.5	① R 0.5	
908.826	10-30	± 0.03	55	2	3.5	② $\phi 1.5$	
908.827	20-40	± 0.03	80	3	6.5	② $\phi 1.5$	
908.828	30-50	± 0.03	80	3	8.5	② $\phi 1.5$	
908.829	40-60	± 0.03	80	3	8.5	② $\phi 1.5$	
Option:							
495.157	Spare battery						

TECHNOBEARING

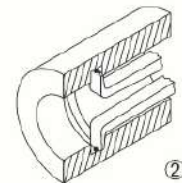
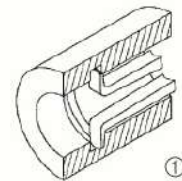
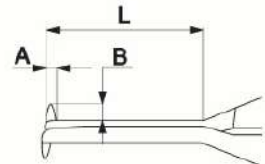

004_306 Technobearing 201 (06/23)

Internal measuring instruments

Internal measuring instruments for measurements of bores, internal grooves and other hard-to-reach places.

- Measuring range: 5 - 60 mm.
- Graduation: 0.01 mm.
- Rotatable dial.
- Adjustable tolerance markers.
- Measuring faces with different contact forms.



908.830

TECHNOBEARING



Item No.	Measuring range/mm	Accuracy mm	Length/mm			Contact form/mm	Price RUB
			L	A	B		
Travel 10 mm:							
908.830	5-15	±0.02	20	1	1.5	① R 0.3	
908.831	10-20	±0.02	25	1.5	3.0	① R 0.3	
908.832	20-30	±0.02	30	2	6.5	① R 0.5	
908.833	30-40	±0.02	30	2.5	9.0	① R 0.5	
908.834	40-50	±0.02	30	2.5	9.0	① R 0.5	
908.836	10-20	±0.02	25	1.5	3.0	② ø 1.5	
908.837	20-30	±0.02	30	2	6.5	② ø 1.5	
908.838	30-40	±0.02	30	2.5	9.0	② ø 1.5	
908.839	40-50	±0.02	30	2.5	9.0	② ø 1.5	
Travel 20 mm:							
908.840	5-25	±0.03	35	1	1.5	① R 0.3	
908.841	10-30	±0.03	55	2	3.5	① R 0.5	
908.842	20-40	±0.03	80	3	6.5	① R 0.5	
908.843	30-50	±0.03	80	3	8.5	① R 0.5	
908.844	40-60	±0.03	80	3	8.5	① R 0.5	
908.846	10-30	±0.03	55	2	3.5	② ø 1.5	
908.847	20-40	±0.03	80	3	6.5	② ø 1.5	
908.848	30-50	±0.03	80	3	8.5	② ø 1.5	
908.849	40-60	±0.03	80	3	8.5	② ø 1.5	

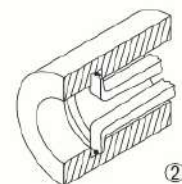
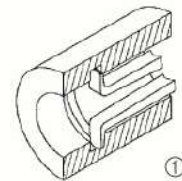
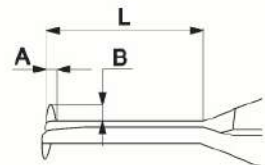

COA.308 Technobearing 201 (9623)

Digital external measuring instruments

Digital external measuring instruments for measurements of external grooves, axis diameters, wall thicknesses and other hard-to-reach places.

- Measuring range: 0-60 mm.
- Resolution: 0.005 mm. Digital-analog display changes automatically between 0.01, 0.02 and 0.05 mm (± 20 scale divisions).
- mm/inch conversion.
- ABS/INC switchable.
- Large LCD display, 340° rotatable.
- On/off switch.
- Automatic switch-off.
- Reset/preset.
- Hold and min/max functions.
- Adjustable tolerance limits.
- Measuring faces with different contact forms.
- Power supply: 1 battery type CR2032.



908.850



Item No.	Measuring range/mm	Accuracy mm	Length/mm L A B	Contact form/mm	Price RUB
Travel 10 mm:					
908.850	0-10	± 0.02	40 3 8	① R 0.5	
908.851	10-20	± 0.02	40 3 8	① R 0.5	
908.852	20-30	± 0.02	40 3 8	① R 0.5	
908.853	30-40	± 0.02	40 3 8	① R 0.5	
908.854	40-50	± 0.02	40 3 8	① R 0.5	
908.855	0-10	± 0.02	40 3 8	② $\phi 1.5$	
908.856	10-20	± 0.02	40 3 8	② $\phi 1.5$	
908.857	20-30	± 0.02	40 3 8	② $\phi 1.5$	
908.858	30-40	± 0.02	40 3 8	② $\phi 1.5$	
908.859	40-50	± 0.02	40 3 8	② $\phi 1.5$	
Travel 20 mm:					
908.860	0-20	± 0.03	80 6.5 25	① R 0.75	
908.861	10-30	± 0.03	80 6.5 25	① R 0.75	
908.862	20-40	± 0.03	80 6.5 25	① R 0.75	
908.863	30-50	± 0.03	80 6.5 25	① R 0.75	
908.864	40-60	± 0.03	80 6.5 25	① R 0.75	
908.865	0-20	± 0.03	80 6.5 25	② $\phi 1.5$	
908.866	10-30	± 0.03	80 6.5 25	② $\phi 1.5$	
908.867	20-40	± 0.03	80 6.5 25	② $\phi 1.5$	
908.868	30-50	± 0.03	80 6.5 25	② $\phi 1.5$	
908.869	40-60	± 0.03	80 6.5 25	② $\phi 1.5$	
Option:					
495.157	Spare battery				

TECHNOBEARING

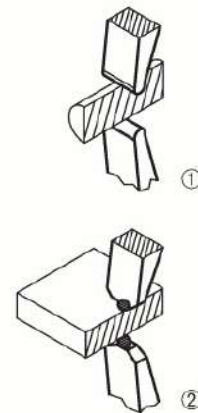
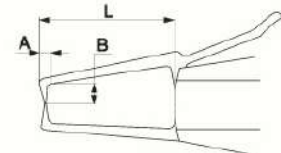

004.307 Technobearing 201 (06/23)

External measuring instruments

External measuring instruments for measurements of external grooves, axis diameters, wall thicknesses and other hard-to-reach places.

- Measuring range: 0-60 mm.
- Graduation: 0.01 mm.
- Rotatable dial.
- Adjustable tolerance markers.
- Measuring faces with different contact forms.



TECHNOBEARING



Item No.	Measuring range/mm	Accuracy mm	Length/mm			Contact form/mm	Price RUB
			L	A	B		
Travel 10 mm:							
908.870	0-10	±0.02	40	3	8	① R 0.5	
908.871	10-20	±0.02	40	3	8	① R 0.5	
908.872	20-30	±0.02	40	3	8	① R 0.5	
908.873	30-40	±0.02	40	3	8	① R 0.5	
908.874	40-50	±0.02	40	3	8	① R 0.5	
908.875	0-10	±0.02	40	3	8	② ϕ 1.5	
908.876	10-20	±0.02	40	3	8	② ϕ 1.5	
908.877	20-30	±0.02	40	3	8	② ϕ 1.5	
908.878	30-40	±0.02	40	3	8	② ϕ 1.5	
908.879	40-50	±0.02	40	3	8	② ϕ 1.5	
Travel 20 mm:							
908.880	0-20	±0.03	80	6.5	25	① R 0.75	
908.881	10-30	±0.03	80	6.5	25	① R 0.75	
908.882	20-40	±0.03	80	6.5	25	① R 0.75	
908.883	30-50	±0.03	80	6.5	25	① R 0.75	
908.884	40-60	±0.03	80	6.5	25	① R 0.75	
908.885	0-20	±0.03	80	6.5	25	② ϕ 1.5	
908.886	10-30	±0.03	80	6.5	25	② ϕ 1.5	
908.887	20-40	±0.03	80	6.5	25	② ϕ 1.5	
908.888	30-50	±0.03	80	6.5	25	② ϕ 1.5	
908.889	40-60	±0.03	80	6.5	25	② ϕ 1.5	

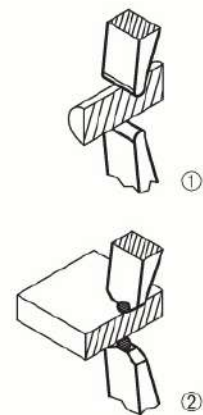
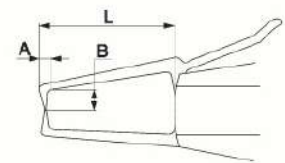

COA 3D9 Technobearing 201 (9623)

Digital thickness gauge

This digital thickness gauge has special, pointed measuring faces for measuring in hard-to-reach places of metal parts.

- Measuring range: 0-15 mm.
- Resolution: 0.01 mm.
- Accuracy: ± 0.03 mm.
- mm/inch conversion.
- On/off switch.
- Reset.
- Weight: 100 g.
- Power supply: 1 battery type V357.

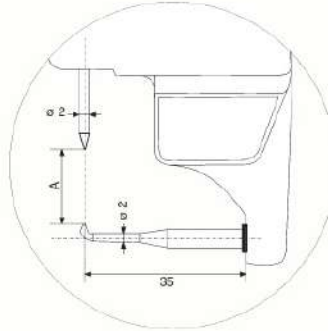

Item No.	Measuring face	Throat depth/mm	Price RUB
906.450	Pointed	35	
Option:			
836.535	Spare battery		

TECHNOBEARING

Digital thickness gauges

The shape of the measuring faces makes this digital thickness gauge especially suitable for measuring metal or plastic film, leather, paper, etc.

- Measuring range: 0-25 mm.
- Resolution: 0.01 mm.
- Accuracy:
 - 0-15 mm: ± 0.03 mm,
 - 0-25 mm: ± 0.04 mm.
- mm/inch conversion.
- On/off switch.
- Reset.
- Weight: 100 g.
- Power supply: 1 battery type V357.

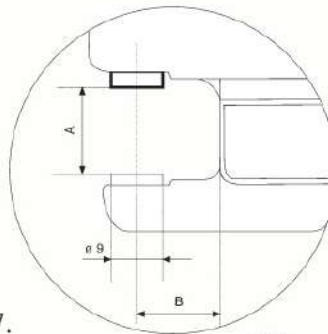

Item No.	Measuring range/mm	Measuring face ϕ /mm	Throat depth/mm	Price RUB
906.451	0-15	9	15.0	
906.452	0-25	9	14.5	
Option:				
836.535	Spare battery			

906.451

COI 2.H.
Technobearing 201 (9623)

Digital external measuring instruments

- Measuring range: 0-10 mm.
- Resolution: 0.01 mm.
- Repeatability: 0.01 mm.
- mm/inch conversion.
- Automatic switch-off.
- Reset.
- Max. measuring speed: 1.5 m/s.
- Non-interchangeable inserts.
- Power supply: 1 battery type V357.

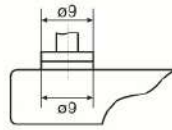

906.453



906.454



Item No.	Measuring range/mm	Measuring faces ϕ /mm	Throat depth/mm	Price RUB
906.453	0-10	9	30	
906.454	0-10	9	120	
Option:				
836.535	Spare battery			

TECHNOBEARING

001.215 Technobearing 201 (9623)

Thickness gauges

- Measuring range: 0-20 mm.
- Graduation: 0.01 mm.
- Rotatable dial.

- Non-interchangeable inserts.
- Measuring face: ϕ 10 mm (906.446: ϕ 6 mm).



906.446



906.447



906.448

TECHNOBEARING

Item No.	Measuring range/mm	Throat depth/mm	Price RUB
906.446	0 - 10	10	
906.447	0 - 10	30	
906.448	0 - 20	110	

Thickness gauges with roller measuring inserts

- Measuring range: 0-10 mm.
- Measuring face: 7 mm/ ϕ 22 mm.
- Throat depth: 100 mm.
- Anvil: 28 x 22 mm (3 mm wheel height in anvil).

Analog

- Graduation: 0.01 mm.
- Rotatable dial with locking screw.
- Adjustable tolerance markers.

Digital

- Resolution: 0.01 mm.
- mm/inch conversion.
- On/off switch.
- Reset.
- Power supply: 1 battery type CR2032.



906.388



906.389

Item No.	Description	Price RUB
906.388	Thickness gauge	
906.389	Digital thickness gauge	
Option:		
495.157	Spare battery	

Peacock external measuring instruments

- Measuring range: 0-10 mm.
- Graduation: 0.01 mm.
- Measuring force: approx. 1.8 N.
- Non-interchangeable measuring inserts.
- Ceramic measuring faces.



855.750

TECHNOBEARING



855.751

Item No.	Measuring range/mm	Measuring faces ϕ /mm	Throat depth/mm	Price RUB
855.750	0-10	10	20	
855.751	0-10	10	120	

External measuring instruments

- Measuring range: 0-10 mm.
- Graduation: 0.01 mm.
- Different types of inserts available, with hardened steel measuring faces.
- Throat depth: 50 mm.

Item No.	Type of insert	Price RUB
853.002	B	
853.003	C	
853.004	D	
853.005	E	
853.007	G	







853.007

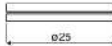

853.002

Types of inserts

-  **B** Wood, rubber, soft leather
-  **C** Soft rubber
-  **D** Rubber rings, round material
-  **E** Paper, cardboard, fibrous plates
-  **G** Metal

Thickness gauge for film measurement

- Measuring range: 0-1 mm.
- Graduation: 0.001 mm.
- Measuring force: approx. 3 N.
- Non-interchangeable measuring inserts.
- Throat depth: 25 mm.
- Frame with insulating grip.

- Delivery with an inspection report.

Item No.	Measuring range/mm	Meas. faces ϕ /mm	Price RUB
907.859	0-1	10	



COI.217. Technobearing 201 (9628)

Thickness gauge for film measurement



- Measuring range: 0 - 1 mm.
- Graduation: 0.001 mm.
- Measuring force: approx. 2 N.
- Non-interchangeable measuring inserts.
- Throat depth: 30 mm.
- Frame with insulating grip.
- Delivery with a declaration of conformity.

Item No.	Measuring range/mm	Meas. faces \varnothing /mm	Price RUB
781.547	0-1	6.35	

Peacock universal thickness gauge

Measuring instrument with dial indicator and adjustable anvil, multi-purpose.

- Span frame: 0 - 20 mm.
- Measuring range dial indicator: 10 mm.
- Graduation: 0.01 mm.
- Throat depth: 25 mm.
- With additional flat insert.

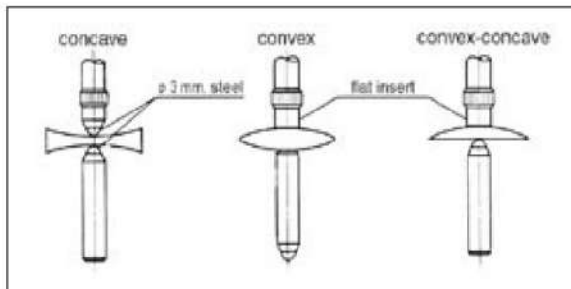

Item No.	Measuring range dial indicator/mm	Price RUB
855.752	0 - 10	

Tube wall thickness gauge



- Measuring range: 0 - 10 mm.
- Graduation: 0.01 mm.
- Measuring force: approx. 1 N.
- Throat depth: 25 mm.
- From inner diameter 8 mm.

Item No.	Measuring range/mm	Price RUB
853.137	0-10	

COI 2/16 Technobearing 2019 06/23







Thickness gauges

- Measuring range: 0-50 mm.
- Graduation: 0.1 mm.
- Different types of inserts.
- Hardened steel measuring faces.
- Other models available on request.

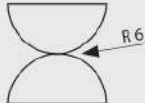

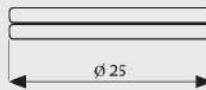
TECHNOBEARING

Types of inserts

- ① General applications 
- ② Wood, rubber, soft leather 
- ③ Soft rubber 
- ④ Paper, cardboard, fibrous plates 
- ⑤ Rubber rings, round materials 
- ⑥ Metal 

Item No.	Measuring range/mm	Type of insert	Throat depth/mm	Price RUB
853.022	0-10	②	15	
853.031	0-30	⑤	50	
853.032	0-30	②	50	
853.033	0-30	③	50	
853.034	0-30	④	50	
853.035	0-30	⑥	50	
853.037	0-30	①	50	
853.041	0-50	⑤	50	
853.042	0-50	②	50	
853.043	0-50	③	50	
853.044	0-50	④	50	
853.045	0-50	⑥	50	
853.047	0-50	①	50	
853.052	0-25	②	150	
853.053	0-25	③	150	
853.054	0-25	①	150	
853.055	0-25	④	150	
853.056	0-25	⑥	150	
853.062	0-25	②	300	
853.063	0-25	③	300	
853.064	0-25	①	300	
853.065	0-25	④	300	
853.066	0-25	⑥	300	
853.082	0-25	②	500	
853.083	0-25	③	500	
853.084	0-25	①	500	
853.085	0-25	④	500	
853.087	0-25	⑥	500	

COI 219 Technobearing 201 (9625)

Digital external measuring instruments

- Measuring range: 0-25 mm.
- Resolution: 0.01 mm.
- mm/inch conversion.
- On/off switch.
- Reset.
- Different types of inserts.
- Hardened steel measuring faces.
- Other models available on request.



Types of inserts

- ① General applications
- ② Wood, rubber, soft leather
- ③ Soft rubber
- ④ Paper, cardboard, fibrous plates
- ⑤ Rubber rings, round materials
- ⑥ Metal

TECHNOBEARING

Item No.	Measuring range/mm	Type of insert	Throat depth/mm	Price RUB
853.072	0-25	①	50	
853.073	0-25	②	50	
853.074	0-25	③	50	
853.075	0-25	④	50	
853.076	0-25	⑤	50	
853.077	0-25	⑥	50	
853.057	0-25	①	200	
853.078	0-25	②	200	
853.079	0-25	③	200	
853.080	0-25	④	200	
853.081	0-25	⑥	200	
853.060	0-25	①	300	
853.091	0-25	②	300	
853.092	0-25	③	300	
853.093	0-25	④	300	
853.094	0-25	⑥	300	

004.316 Technobearing 201 (RUB25)

**Dial indicators / Dial test indicators / Center instruments
Edge finders / Probes / MF measuring fixture system**

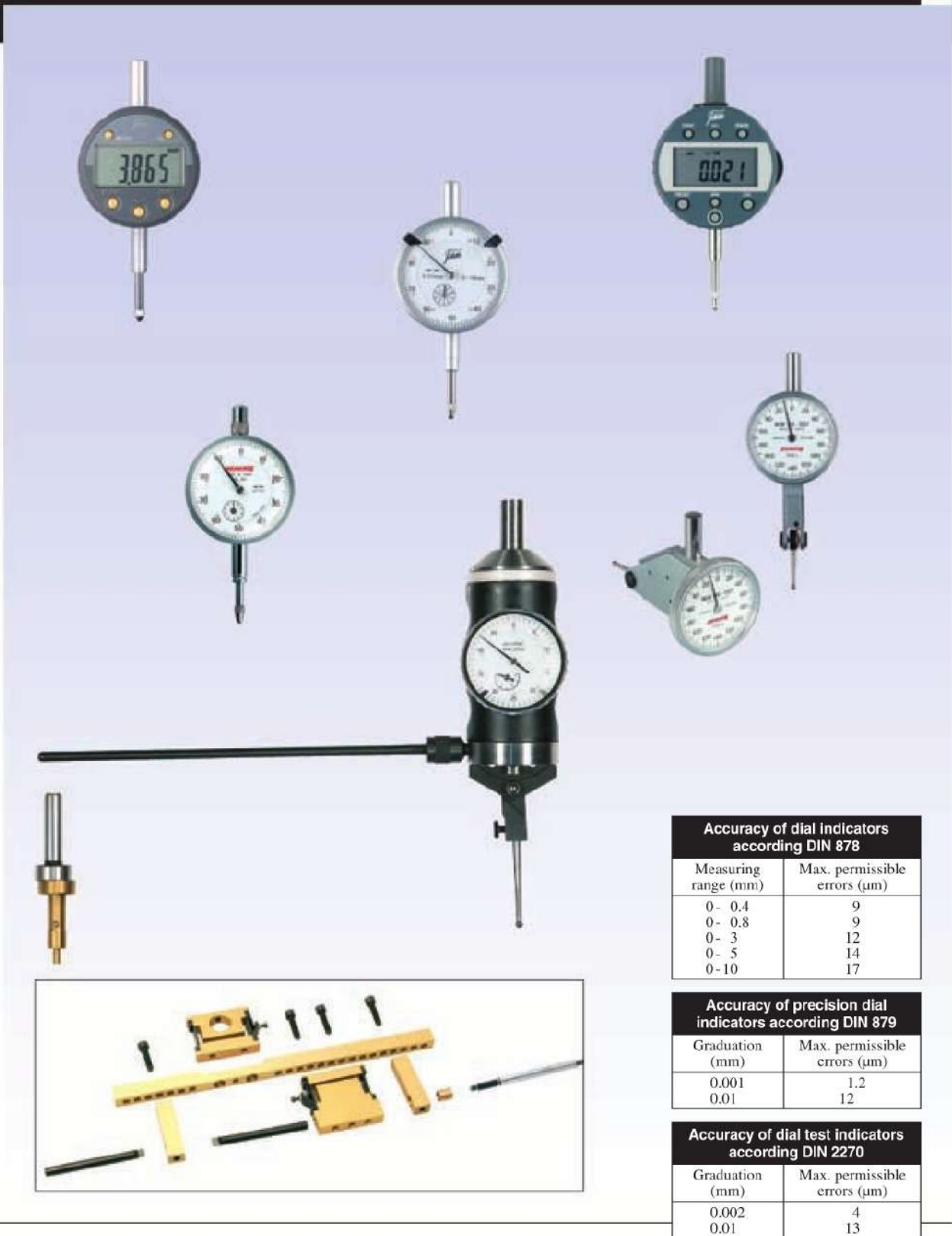

Accuracy of dial indicators according DIN 878	
Measuring range (mm)	Max. permissible errors (µm)
0 - 0.4	9
0 - 0.8	9
0 - 3	12
0 - 5	14
0-10	17

Accuracy of precision dial indicators according DIN 879	
Graduation (mm)	Max. permissible errors (µm)
0.001	1.2
0.01	12

Accuracy of dial test indicators according DIN 2270	
Graduation (mm)	Max. permissible errors (µm)
0.002	4
0.01	13

003.D01. Technobearing 201 (REV23)

Digital dial indicators 0.01 and 0.001 mm

Digital dial indicators for a favourable price.

- Measuring range: 0-50 mm.
- Resolution: 0.01 or 0.001 mm.
- mm/inch conversion.
- ABS/INC switchable.
- On/off switch.
- Reset.
- Clamping stem: \varnothing 8 mm.
- Dial diameter: 57 mm.
- Adjustable tolerance limits.
- Flat back and additional back with lug.
- Delivery with an inspection report.
- Power supply: 1 battery type CR2025.



907.652



907.646

TECHNOBEARING



Item No.	Measuring range/mm	Accuracy mm	Price RUB
With resolution 0.01 mm:			
907.634	0-12.5	± 0.02	
907.649	0-25	± 0.03	
907.652	0-50	± 0.04	
With resolution 0.001 mm:			
907.646	0-12.5	± 0.015	
Options:			
495.214	Spare battery		
909.446	USB interface		
909.687	Footswitch for USB interface		



909.446

- USB interface:**
- For data transfer to PC (e.g. Excel, Word).
 - Operating system: Windows and other.
 - PC connection: USB.
 - No software or driver to install.
 - Foot switch (optional).

Absolute digital dial indicators

Absolute digital dial indicators with function to set tolerance limits with clear optical Go (NoGo) reading.

- Measuring range: 0-50 mm.
- Resolution: 0.01 mm or 0.001 mm.
- mm/inch conversion.
- ABS/INC switchable.
- With data output.
- Adjustable tolerance limits.
- **Tolerance display** by means of illuminated green LED at GO value.
- On/off switch.
- Reset/preset.
- Ceramic stylus tip.
- Max. measuring speed: unlimited.
- Clamping stem: \varnothing 8 mm.
- Dial diameter: 60 mm.
- Reversible measuring direction.
- Flat back.
- With additional back with lug.
- Protection: IP54.
- Delivery in a case with an inspection report.
- Power supply: 1 battery type CR2032.

TECHNOBEARING

NEW



906.870



906.618

USB interface:

- For data transfer to PC (e.g. Excel, Word).
- Operating system: Windows and other.
- PC connection: USB.
- No software or driver to install.
- Foot switch (optional).



909.687

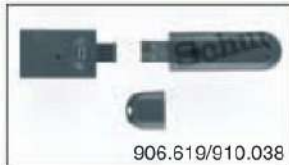

906.619/910.038

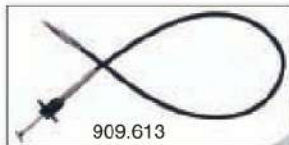

909.613



909.614

PRICE

Item No.	Measuring range/mm	Resolution mm	Accuracy mm	Price RUB
910.221	0-12.5	0.001	± 0.004	
910.222	0-25	0.001	± 0.004	
910.223	0-50	0.001	± 0.005	
906.870	0-12.5	0.01	± 0.01	
906.871	0-25	0.01	± 0.01	
906.872	0-50	0.01	± 0.015	

Options:

- 495.157 Spare battery
- 906.618 USB interface
- 909.687 Footswitch for USB interface
- 910.038 Wireless USB receiver
- 906.619 Wireless transmitter
- 909.611 Retraction lever
- 909.613 Cable retraction device (0.7 m) (maximum travel 10 mm)
- 909.614 Retraction lever (maximum travel 12.7 mm)

001.330 Technobearing 201 (94628)

Absolute digital dial indicators

- Measuring range: 0-50.8 mm.
- Resolution: 0.01 mm or 0.001 mm.
- mm/inch conversion.
- ABS/INC switchable.
- LCD display 330° rotatable.
- Digimatic data output.
- On/off switch.
- Reset/preset.
- Ceramic stylus tip.
- Max. measuring speed: unlimited.
- Measuring force: ≤ 2 N.
- Clamping stem: ø 8 mm.
- Dial diameter: 60 mm.
- Reversible measuring direction.
- With determination of the reversal point (only 910.004).

TECHNOBEARING

- Adjustable tolerance limits (except 910.004).
- Flat back.
- With additional back with lug (only 909.998, 910.001/004).
- Protection: IP54.
- Delivery in a case with an inspection report.
- Power supply: 1 battery type CR2032.



USB interface:

- For data transfer to PC (e.g. Excel, Word).
- Operating system: Windows and other.
- PC connection: USB.
- No software or driver to install.
- Foot switch (optional).

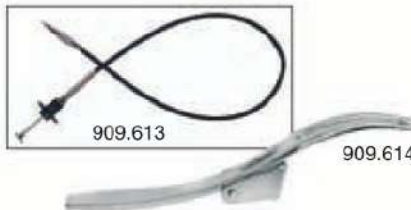

Item No.	Measuring range/mm	Resolution mm	Accuracy mm	Price RUB
909.998	0-12.7	0.001	±0.004	
909.999	0-25.4	0.001	±0.005	
910.000	0-50.8	0.001	±0.006	
910.001	0-12.7	0.01	±0.01	
910.002	0-25.4	0.01	±0.01	
910.003	0-50.8	0.01	±0.015	

For internal measurements:

910.004	0-12.7	0.001	±0.004
---------	--------	-------	--------

With Bluetooth:

910.079	0-12.7	0.001	±0.004
910.082	0-12.7	0.01	±0.01

Options:

- 495.157 Spare battery
- 909.686 USB interface
- 909.687 Footswitch for USB interface
- 910.038 Wireless USB receiver
- 910.039 Wireless transmitter
- 909.611 Retraction lever
- 909.613 Cable retraction device (0.7 m) (maximum travel 10 mm)
- 909.614 Retraction lever (maximum travel 12.7 mm)



Digital dial indicators

Digital dial indicators with digital and digital-analog read-out.

- Measuring range: 0- 12.5 mm.
- Resolution: 0.002 or 0.001 mm.
- mm/inch conversion.
- ABS/INC switchable.
- On/off switch.
- Automatic switch-off.
- Reset/preset.
- Clamping stem: \varnothing 8 mm.
- Dial diameter: 62 mm.
- Dial 360° rotatable.
- Reversible measuring direction.
- With determination of the reversal point.
- Adjustable tolerance limits.
- Power supply: 1 battery type CR2032.



Item No.	Measuring range/mm	Resolution mm	Accuracy mm	Measuring force/N	Price RUB
909.250	0- 12.5	0.002	± 0.015	1.8 - 3.0	
909.251	0- 12.5	0.001	± 0.006	2.2 - 3.5	
Option: 495.157 Spare battery					



Digital dial indicators

Universal digital indicators with both digital and digital-analog display of the measuring value, and can also be rotated over 340° to ensure easy read-out in all positions.

- Measuring range: 0- 12.7 mm.
- Resolution: 0.001 mm.
- Analog resolution: 0.001/0.002/0.01/0.02/0.05 mm.
- mm/inch conversion.
- ABS/INC switchable.
- On/off switch.
- Automatic switch-off.
- Reset/preset.
- Clamping stem: \varnothing 8 mm.
- Dial diameter: 61 mm.
- Dial 340° rotatable.
- Reversible measuring direction.
- Adjustable tolerance limits.
- Protection: IP54.
- Power supply: 1 battery type CR2032.



Item No.	Measuring range/mm	Accuracy mm	Price RUB
907.879	0- 12.7	± 0.01	
907.878	0- 12.7	± 0.005	
Option: 495.157 Spare battery			

TECHNOBEARING



007.020 Technobearing 201 04628

Absolute horizontal digital dial indicators

- Measuring range: 0-30 mm.
- Resolution: 0.001 mm.
- mm/inch conversion.
- Digimatic data output.
- On/off switch.
- Reset/preset.
- Ceramic stylus tip.
- With dovetail joint (incl. lug) and clamping stem $\varnothing 8$ mm.

- Measuring force: ≤ 2 N.
- Reversible measuring direction.
- Protection: IP54.
- Delivery in a case with an inspection report.
- Power supply: 1 battery type CR1632.

USB interface and wireless USB receiver and transmitter available on request.



Item No.	Measuring range/mm	Resolution mm	Accuracy mm	Price RUB
910.085	0-12.7	0.001	± 0.005	
910.086	0-30	0.001	± 0.006	
Option: 497.955 Spare battery				

TECHNOBEARING

Digital dial indicator with calculation function

Robust digital dial indicator with built-in calculation function for easy determination of diameters by means of measuring a curved surface. Suitable for measuring both inside and outside diameters and multifunctional dial indicator applications. Delivery with measuring bases of 10, 20, 30, 60 and 100 mm.

- Measuring range: 0-13 mm.
- Resolution: 0.005 mm.
- mm/inch conversion.
- On/off switch.
- Reset.

- Hold function.
- Clamping stem: $\varnothing 8$ mm.
- Aluminum construction.
- Delivery in a case.
- Power supply: 1 battery type CR2032.



Item No.	Measuring range/mm	Accuracy mm	Price RUB
907.884	0-13	$\pm 0.005^*$	
Option: 495.157 Spare battery			



* Accuracy of the indicator without the use of measuring bases. The accuracy with measuring bases depends on the radius and form deviation of the workpiece.

001.029 Technobearing 201 (9625)

Dial indicators 0.01 mm

Indicators with an excellent price-performance ratio.

- Measuring range: 0- 10 mm.
- Graduation: 0.01 mm.
- Clamping stem: \varnothing 8 mm.
- Dial diameter: 55 mm.
- Rotatable dial.
- Shockproof.
- Adjustable tolerance markers.
- Flat back.
- Delivery with an inspection report.
- Retraction lever available on request (only 907.929/930).



Item No.	Measuring range/mm	Price RUB
907.928	0- 3	
907.929	0- 5	
907.930	0- 10	
Option:		
908.799	Back with lug	

Dial indicators 0.01 mm

Indicators with a large dial and a locking screw. Shockproof design.

- Measuring range: 0- 10 mm.
- Graduation: 0.01 mm.
- Clamping stem: \varnothing 8 mm.
- Dial diameter: 60 mm.
- Rotatable dial.
- Shockproof.
- Adjustable tolerance markers.
- Locking screw.
- Flat back.
- Delivery with an inspection report.



NEW

TECHNOBEARING



Item No.	Measuring range/mm	Price RUB
907.931	0- 3	
907.932	0- 5	
907.933	0- 10	
Options:		
908.987	Back with lug	
906.359	Retraction lever	



Dial indicators 0.01 mm

Indicators with a large measuring range. Shockproof design.

- Measuring range: 0 - 100 mm.
- Graduation: 0.01 mm.
- Clamping stem: \varnothing 8 mm.
- Rotatable dial.
- Shockproof.
- Adjustable tolerance markers (except 907.916).
- Locking screw.
- Flat back.
- Delivery with an inspection report.



Item No.	Measuring range/mm	Dial \varnothing /mm	Price RUB
907.934	0 - 25	60	
907.935	0 - 30	60	
907.936	0 - 50	76	
907.916	0 - 100	80	

Options:
 908.987¹ Back with lug
 908.988² Back with lug

¹ For 907.934/935.

² For 907.936/916.

Splashproof dial indicators 0.01 mm

Indicators with splashproof design.

- Measuring range: 0 - 10 mm.
- Graduation: 0.01 mm.
- Clamping stem: \varnothing 8 mm.
- Dial diameter: 55 mm.
- Rotatable dial.
- Shockproof.
- Adjustable tolerance markers.
- Locking screw.
- Back with lug.
- Protection: IP54.
- Conforms to factory standard.



Item No.	Measuring range/mm	Price RUB
908.777	0 - 3	
908.778	0 - 5	
908.779	0 - 10	

TECHNOBEARING

003_203 Technobearing 201 (9623)

Miniature dial indicators 0.01 and 0.001 mm

Indicators with very small dimensions and an excellent price-performance ratio. Shockproof design.

- Measuring range: 0-10 mm.
- Graduation: 0.01 or 0.001 mm.
- Clamping stem: \varnothing 8 mm.
- Dial diameter: 40 mm.
- Rotatable dial.
- Shockproof.
- Adjustable tolerance markers.
- Locking screw.
- Flat back.
- Delivery with an inspection report.



Item No.	Measuring range/mm	Price RUB
Graduation 0.01 mm:		
907.925	0- 3	
907.926	0- 5	
907.927	0- 8	
907.914	0-10	
Graduation 0.001 mm:		
907.920	0- 1	
Option:		
908.986	Back with lug	



Dial indicators 0.001 mm

Indicators with micrometer reading. Shockproof design.

- Measuring range: 0-5 mm.
- Graduation: 0.001 mm.
- Clamping stem: \varnothing 8 mm.
- Dial diameter: 60 mm.
- Rotatable dial.
- Scale numbering: 0-100-0.
- Shockproof.
- Adjustable tolerance markers.
- Locking screw.
- Flat back.
- Delivery with an inspection report.



Item No.	Measuring range/mm	Price RUB
907.921	0-1	
907.922	0-2	
907.923	0-3	
907.924	0-5	
Option:		
908.987	Back with lug	



TECHNOBEARING

003.311. Technobearing 201 (9623)

Peacock dial indicators 0.1 and 0.01 mm

- Measuring range: 0-80 mm.
- Graduation: 0.1 or 0.01 mm.
- Clamping stem: \varnothing 8, 10 or 14 mm.
- Rotatable dial.
- Adjustable tolerance markers.
- Flat back or back with lug*.
- DIN 878.
- Delivery in a case.

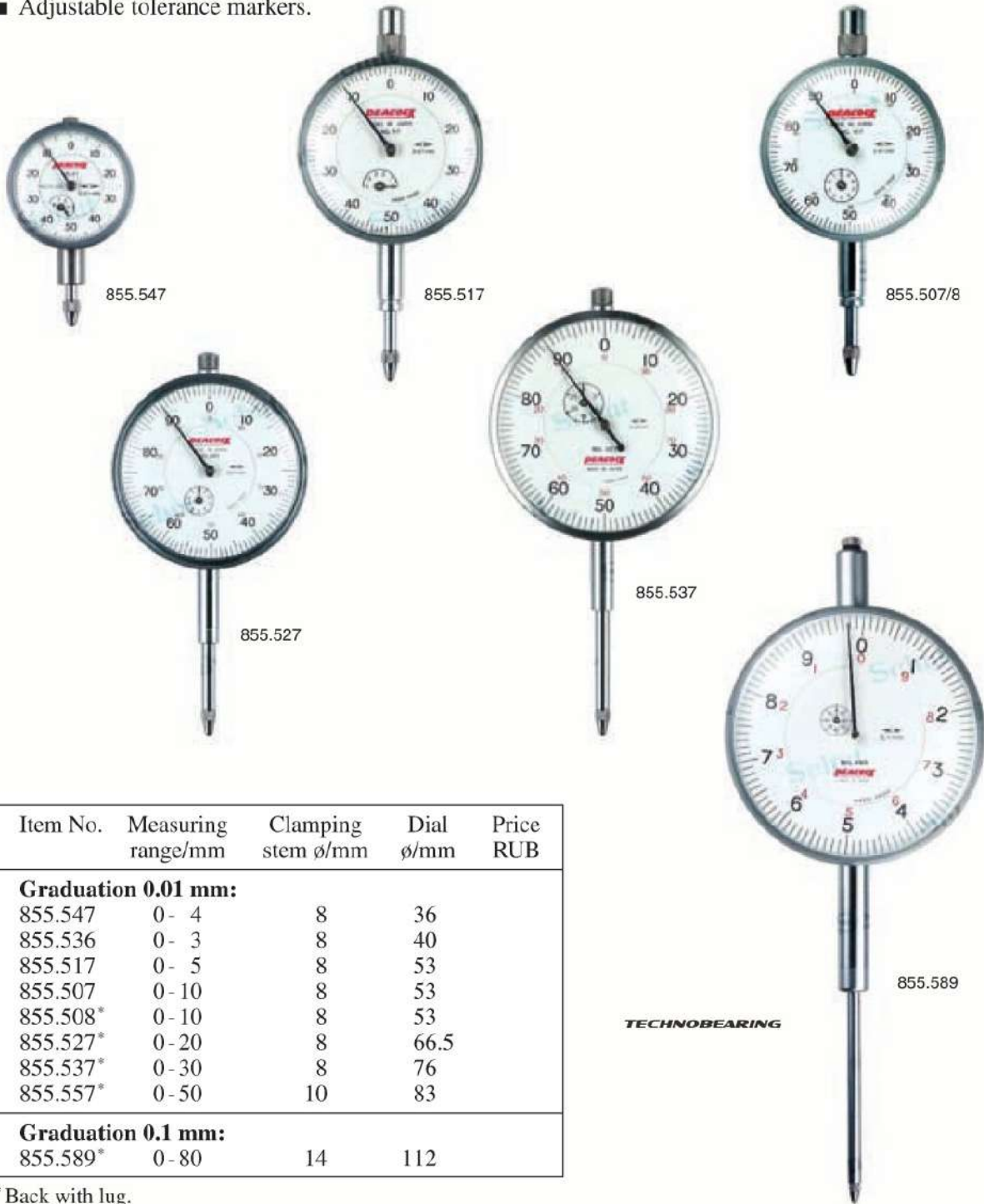

Item No.	Measuring range/mm	Clamping stem \varnothing /mm	Dial \varnothing /mm	Price RUB
Graduation 0.01 mm:				
855.547	0 - 4	8	36	
855.536	0 - 3	8	40	
855.517	0 - 5	8	53	
855.507	0 - 10	8	53	
855.508*	0 - 10	8	53	
855.527*	0 - 20	8	66.5	
855.537*	0 - 30	8	76	
855.557*	0 - 50	10	83	
Graduation 0.1 mm:				
855.589*	0 - 80	14	112	

* Back with lug.

TECHNOBEARING

003.216 Technobearing 201 (06/23)

Peacock dial indicators 0.005 and 0.001 mm

- Measuring range: 0-5 mm.
- Graduation: 0.005 or 0.001 mm.
- Clamping stem: \varnothing 8 mm.
- Rotatable dial.
- Flat back or back with lug*.
- DIN 878.
- Delivery in a case.

Item No.	Measuring range/mm	Dial \varnothing /mm	Price RUB
Graduation 0.005 mm:			
855.535*	0-3	47	
Graduation 0.001 mm:			
855.509	0-1	53	
855.525*	0-2	66.5	
855.555*	0-5	66.5	

* Back with lug.



Peacock dial indicators with back plunger

The back plunger dial indicator is characterized with easy handling since the spindle with the contact point is moving in the direction perpendicular to the dial face and the gauge is more compact. The dial indicator of this type is convenient for use in achieving a parallelism of the table of the machine tool, with measuring jigs, in restricted areas and on locations where scale reading is difficult.

- Measuring range: 0-5 mm.
- Graduation: 0.01 mm.
- Repeatability: 0.005 mm.
- Hysteresis: \pm 0.006 mm.
- Measuring force: 1.4 N.
- Rotatable dial.
- Scale numbering: 0-100.
- DIN 878.
- Delivery in a case.

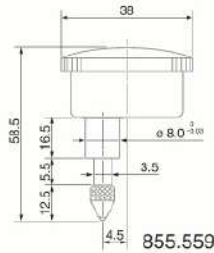
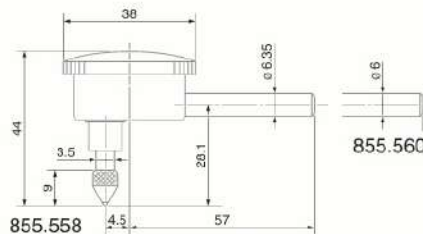

Item No.	Measuring range/mm	Clamping stem \varnothing /mm	Accuracy mm	Price RUB
855.558	0-5	6.35	\pm 0.02	
855.560	0-5	6	\pm 0.02	
Clamping stem on back side:				
855.559	0-5	8	\pm 0.02	

Precision dial indicator

Highly accurate shockproof dial indicator for measurements from a fixed reference point. Very suitable for internal measuring instruments and dial indicator stands for example.

- Measuring range: 0.1 mm.
- Graduation: 0.001 mm.
- Measuring force: < 2 N.
- Clamping stem: \varnothing 8 mm.
- Travel: 3 mm.
- Adjustable tolerance markers.
- Fine adjustment.
- Delivery with an inspection report.



TECHNOBEARING

Item No.	Measuring range/mm	Dial \varnothing /mm	Price RUB
907.939	0.1	63.5	

Precision dial indicators

- Measuring range: 0.06 mm.
- Graduation: 0.0005 mm or 0.001 mm.
- Measuring force: approx. 1 N.
- Clamping stem: \varnothing 28 mm.
- Shockproof.
- Fine adjustment.
- Delivery with an inspection report.



906.333

Item No.	Measuring range/mm	Resolution mm	Scale numbering	Price RUB
906.332	0.03	0.0005	15-0-15	
906.333	0.06	0.001	30-0-30	

003.215 Technobearing 201 (94628)

Inserts

Inserts with thread M2.5. The inserts are made of steel unless otherwise indicated; tungsten carbide (TC), ruby (R) or sapphire (S).

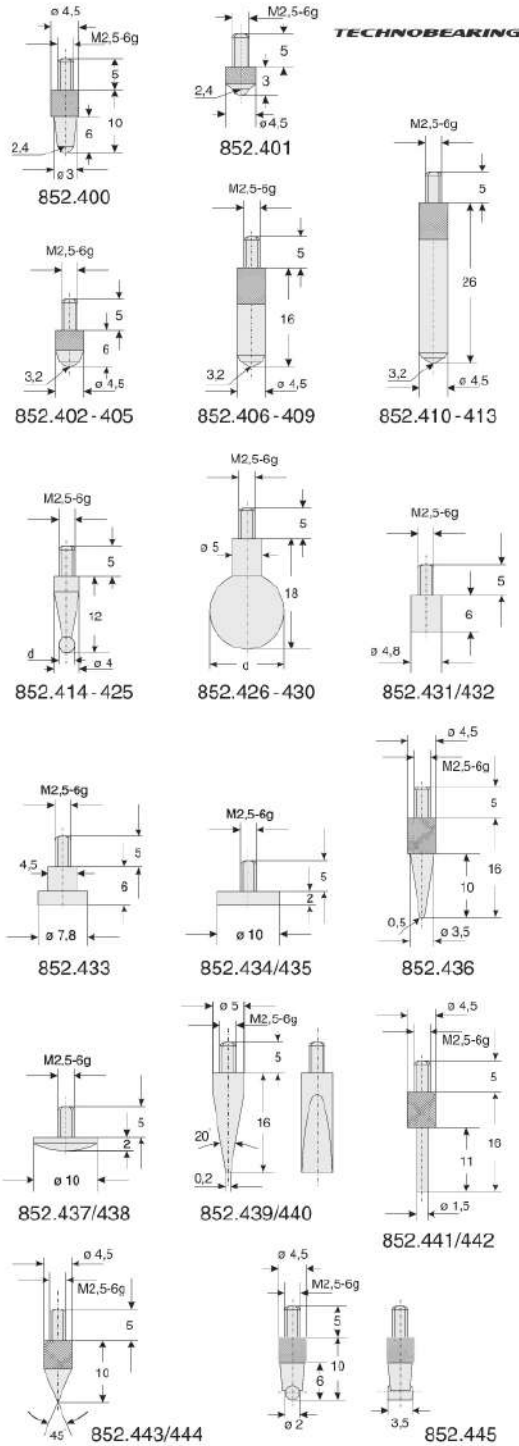

Item No.	Description	Price RUB
Ball probes:		
852.400	d= 2.4 mm l= 10 mm	
852.401	d= 2.4 mm l= 3.0 mm	
852.402	d= 3.2 mm l= 6.0 mm	
852.403	d= 3.2 mm l= 6.0 mm	TC
852.404	d= 3.2 mm l= 6.0 mm	R
852.405	d= 3.2 mm l= 6.0 mm	S
852.406	d= 3.2 mm l= 16 mm	
852.407	d= 3.2 mm l= 16 mm	TC
852.408	d= 3.2 mm l= 16 mm	R
852.409	d= 3.2 mm l= 16 mm	S
852.410	d= 3.2 mm l= 26 mm	
852.411	d= 3.2 mm l= 26 mm	TC
852.412	d= 3.2 mm l= 26 mm	R
852.413	d= 3.2 mm l= 26 mm	S
852.420	d= 1.0 mm l= 12 mm	TC
852.415	d= 2.0 mm l= 12 mm	
852.421	d= 2.0 mm l= 12 mm	TC
852.416	d= 3.0 mm l= 12 mm	
852.422	d= 3.0 mm l= 12 mm	TC
852.417	d= 4.0 mm l= 12 mm	
852.423	d= 4.0 mm l= 12 mm	TC
852.418	d= 5.0 mm l= 12 mm	
852.424	d= 5.0 mm l= 12 mm	TC
852.419	d= 6.0 mm l= 12 mm	
852.425	d= 6.0 mm l= 12 mm	TC
852.426	d= 7.0 mm l= 18 mm	
852.427	d= 8.0 mm l= 18 mm	
852.428	d= 9.0 mm l= 18 mm	
852.429	d= 10.0 mm l= 18 mm	
852.430	d= 11.0 mm l= 18 mm	
Flat probes:		
852.431	d= 4.8 mm l= 6 mm	
852.432	d= 4.8 mm l= 6 mm	TC
852.433	d= 7.8 mm l= 6 mm	
852.434	d= 10.0 mm l= 2 mm	
852.435	d= 10.0 mm l= 2 mm	TC
Spherical probes:		
852.436	conical l= 16 mm	
852.437	d= 10.0 mm l= 2.0 mm	
852.438	d= 10.0 mm l= 2.0 mm	TC
Knife-edged probes:		
852.439	d= 5.0 mm l= 16 mm	
852.440	d= 5.0 mm l= 16 mm	TC
Needle-shaped probes:		
852.441	d= 1.5 mm l= 16 mm	
852.442	d= 1.5 mm l= 16 mm	TC
Tapered probes:		
852.443	d= 4.5 mm l= 10 mm point 45°	
852.444	d= 4.5 mm l= 10 mm point 45°	TC
Probe with cylindrical measuring face:		
852.445	d= 2 x 3.5 mm l= 10 mm	

003.231. Technobearing 201 (9625)

Extensions for inserts

Steel extensions for inserts with thread M2.5.

Item No.	Length mm	Price RUB
Extensions with $\Lambda = \phi 4$ mm:		
852.446	10	
852.447	15	
852.448	20	
852.449	25	
852.450	30	
852.451	35	
852.452	40	
852.453	45	
852.454	50	
852.455	55	
852.456	60	
852.457	65	
852.458	70	
852.459	75	
852.460	80	
852.461	85	
852.462	90	
852.463	95	
852.464	100	

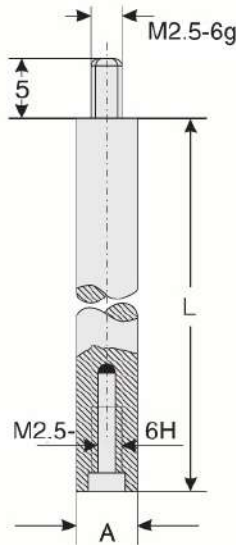

Item No.	Length mm	Price RUB
Extensions with $\Lambda = \phi 5$ mm:		
852.465	10	
852.466	15	
852.467	20	
852.468	25	
852.469	30	
852.470	35	
852.471	40	
852.472	45	
852.473	50	
852.474	55	
852.475	60	
852.476	65	
852.477	70	
852.478	75	
852.479	80	
852.480	85	
852.481	90	
852.482	95	
852.483	100	

Adapters for inserts

Adapter for attaching other inserts to dial indicators and probes with an interchangeable insert with thread M2.5.

Item No.	External/internal thread	Price RUB
960.276	M2.5/M2	

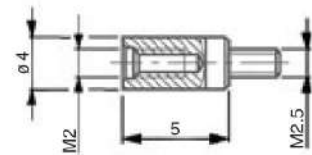

Depth measuring bases for dial indicators

Bases which make dial indicators and probes suitable for depth measurements.

- Clamping shaft: 8H7.

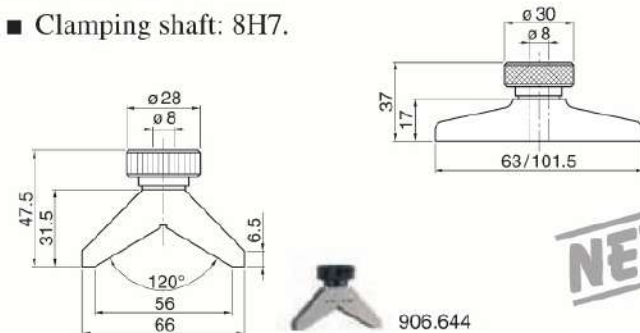

907.153

TECHNOBEARING

NEW

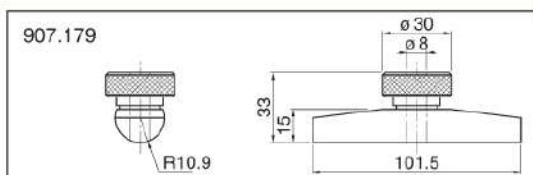

Item No.	Measuring face l x w/mm	Price RUB
907.153	63 x 17	
907.165	101.5 x 17	
906.644	66 x 16	
With cylindrical measuring face:		
907.179	101.5 x R10.9	

Clamping bush



Item No.	Description	Price RUB
780.398	Clamping bush VKE	
780.397	Clamping screw VKD	

Swivel-type probe

Swivel-type probe for dial indicators with M2.5 thread. The probe can be oriented over 180°. Equipped with a steel ball probe ø 3 mm.

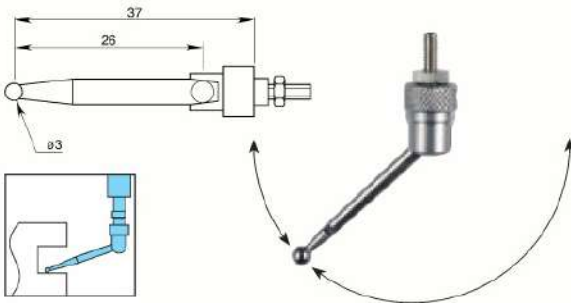

Item No.	Description	Price RUB
900.391	Swivel-type probe	

Angle probe and special probe

Probes e.g. for checks and alignments of bores on lathes.

- Probe measuring range: 10 mm.
- Measuring depth: 30 mm (856.149) or 60 mm (856.150).
- Clamping stem: ø 8 mm.
- Clamping shaft: ø 8 mm.



Item No.	Description	Price RUB
856.149	Angle probe	
856.150	Special probe	

Clamping bush

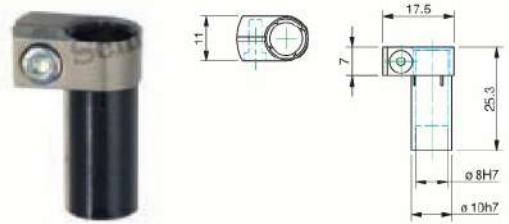

Item No.	Description	Price RUB
906.497	Clamping bush	

Angle probe

Angle probe used for the transmission of the plunger movements up to 10 mm. Suited for dial indicators with a 0.01 mm graduation. Delivery incl. flat insert ø 5 mm.

- Probe measuring range: 10 mm.
- Clamping shaft: ø 8 mm.



Item No.	Description	Price RUB
782.440	Angle probe	

Probe holder

Probe holder for for surfacemounting.

- Clamping shaft: ø 8 mm.
- For attaching with M4 bolts.
- Material: anodized aluminum.

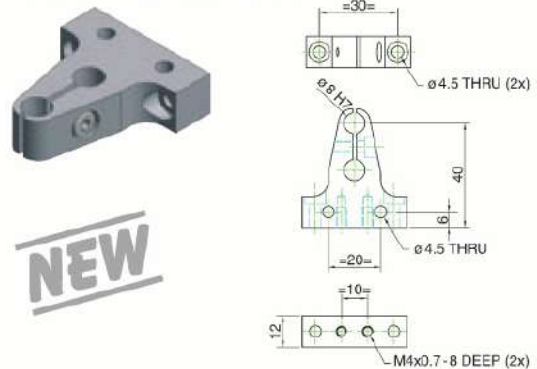

Item No.	Description	Price RUB
993.054	Probe holder	

Lever-type test indicators

- Measuring range: up to 0.8 mm.
- Graduation: 0.01 or 0.002 mm.
- With dovetail joint and clamping stems $\varnothing 6$ and $\varnothing 8$ mm.
- Dial diameter: 40 mm.

- Rotatable dial.
- Stylus tip: $\varnothing 2$ mm.
- Delivery with an inspection report.

NEW



907.941

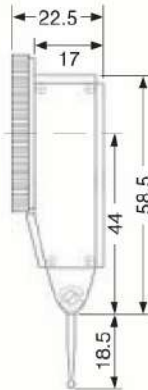

907.942

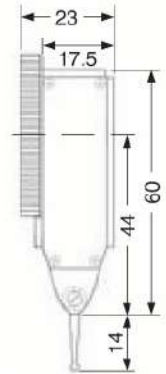

909.114/115



906.663/664

Item No.	Measuring range/mm	Graduation mm	Scale numbering	Insert length/mm	Price RUB
907.941	0.8	0.01	0-40-0	19	
907.942	0.2	0.002	0-100-0	13	

Options:

- 909.114 Steel spare stylus tip for 907.941
- 909.115 Steel spare stylus tip for 907.942
- 906.663 Ruby spare stylus tip for 907.941
- 906.664 Ruby spare stylus tip for 907.942



TECHNOBEARING
Clamping stem $\varnothing 6/\varnothing 8$ mm.

Lever-type digital test indicator

Lever-type digital test indicator with tolerance judgement. Suitable for measurements in both directions. Equipped with three dovetail mountings.

- Measuring range: up to 0.5 mm.
- Resolution: 0.001 mm.
- Accuracy: ± 0.02 mm.
- mm/inch conversion.
- On/off switch.
- Reset.
- Measuring force: ≤ 0.6 N.
- With dovetail joint and clamping stems $\varnothing 6$ and $\varnothing 8$ mm.
- Ruby stylus tip: $\varnothing 2$ mm.



- 230° adjustable measuring insert.
- Adjustable tolerance limits.
- Power supply: 1 battery type V357.



Item No.	Measuring range/mm	Resolution mm	Insert length/mm	Price RUB
907.574	0.5	0.001	17	

Options:

- 836.535 Spare battery
- 907.769 Spare stylus tip

Peacock lever-type dial test indicators

- Measuring range: up to 1 mm.
- Graduation: 0.01, 0.002 or 0.001 mm.
- With dovetail joint and clamping stem $\varnothing 6$ mm.
- Measuring force: <0.3 N (except 855.610: 0.05 N).
- Tungsten carbide stylus tip: $\varnothing 2$ mm.
- Insert thread: M1.7.

Inserts for lever-type dial test indicators

Item No.	Effective length (EL)/mm	Ball \varnothing /mm	Price RUB
For 855.601, 855.605 and 855.610:			
859.016	17.74	2	
859.152	17.74	1	
859.151	17.74	0.8	
859.290	17.74	0.5	
For 855.602:			
859.126	39.00	2	
859.291	39.00	1	
859.292	39.00	0.8	
859.293	39.00	0.5	
For 855.603 and 855.606:			
859.200	14.33	2	
859.294	14.33	1	
859.295	14.33	0.8	
859.296	14.33	0.5	
For 855.604:			
859.259	8.13	2	
859.297	8.13	1	
859.298	8.13	0.8	
859.299	8.13	0.5	
For 855.611:			
859.464	19.24	2	
859.465	19.24	1	
859.466	19.24	0.8	
859.467	19.24	0.5	



Item No.	Measuring range/mm	Graduation mm	Dial \varnothing /mm	Scale numbering	Insert	Total insert length (TL)/mm	Price RUB
Horizontal:							
855.601	0.5	0.01	35	0-25-0	859.016	21.3	
855.602	1	0.01	35	0-50-0	859.126	42.8	
855.603	0.28	0.002	35	0-140-0	859.200	17.9	
855.604	0.14	0.001	35	0-70-0	859.259	11.7	
855.611	0.8	0.01	35	0-40-0	859.464	22.4	
855.610	0.5	0.01	35	0-25-0	859.016	21.3	
Perpendicular:							
855.605	0.5	0.01	35	0-25-0	859.200	21.3	
855.606	0.28	0.002	35	0-140-0	859.200	17.9	

003.225 Technobearing 201 (9623)

Accessories dial indicators/dial test indicators

Item No.	Description	Price RUB
909.433	Centering support $\varnothing 8 \times 25$ mm, holder $\varnothing 4$ mm	
909.434	Rectangular fixing shaft $12 \times 6 \times 76$ mm, holder $\varnothing 4/\varnothing 8$ mm and dovetail clamp	
909.435	Rectangular fixing shaft $12 \times 6 \times 76$ mm, holder $\varnothing 6/\varnothing 8$ mm and dovetail clamp	
909.436	Rectangular fixing shaft $9 \times 9 \times 76$ mm, holder $\varnothing 4/\varnothing 8$ mm and dovetail clamp	
909.437	Rectangular fixing shaft $9 \times 9 \times 76$ mm, holder $\varnothing 6/\varnothing 8$ mm and dovetail clamp	
909.438	Round, swivelling fixing shaft $\varnothing 6 \times 70$ mm, holder with dovetail clamp	
909.439	Round, swivelling fixing shaft $\varnothing 8 \times 70$ mm, holder with dovetail clamp	



Reducer



837.190

TECHNOBEARING

Item No.	Thread	Price RUB
781.819	$\varnothing 8 \rightarrow 4$ mm	
837.190	$\varnothing 8 \rightarrow 6$ mm	

Center-accessory

Small magnetic dial indicator stand which, in combination with a lever, could also be used as center-accessory to align bores in workpieces. For use in combination with a machine center.

- Permanent magnet $\varnothing 27$ mm.
- Universal pivot with dovetail clamp.
- Delivery incl. cylindrical support $\varnothing 9.5$ mm for insert in the collet chuck of a machine center.



Item No.	Description	Price RUB
781.997	Center-accessory	

003.315 Technobearing 201 (9623)

Centering device

Convenient tool to find and set up the position of a workpiece on vertical and horizontal machines. It can also be used to determine the position of a workpiece when the spindle is rotated by hand or automatic. Easy read-out from stationary dial indicator. Instrument with compact dimensions.

- Max. range of use: 300 mm.
- Scale read-out per rotation: 0-3 mm.
- Graduation: 0.01 mm.
- Centering inside and outside with various probes.
- 3 straight and 3 bended probes included.
- Center feeler included.
- Spindle rotating speed max. 800 rpm.
- Compact dimensions.
- For horizontal and vertical use suitable.
- Clamping stem: ϕ 10 mm.
- Delivery in a case.

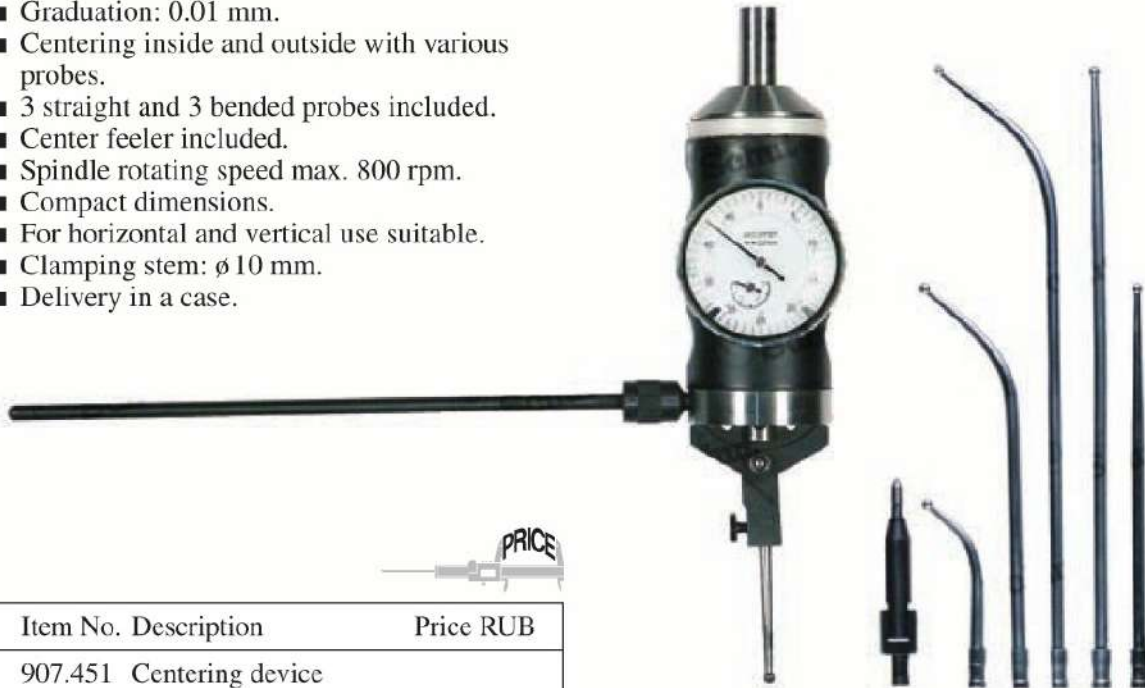

Item No.	Description	Price RUB
907.451	Centering device	
Option:		
907.445	Probe set (7 pieces)	

Edge finders

Edge finders for both stationary and rotating use. As soon as the workpiece is touched by the ballprobe the all around visible LED will light up due to galvanic contact. The ballprobe is held in place by a spring. When the pressure on the tip becomes too large the ball will flip away sideways. The edge finders are also available with additional sound signal for extra working comfort.

- Concentricity: <0.01 mm.
- Diameter ballprobe: 10 mm.
- Delivery in a case.
- Power supply:
907.456/460: 2 batteries type V357,
907.454/458: 1 battery type 23A.



Item No.	Clamping stem ϕ /mm	Length mm	Price RUB
907.454	20	162	
907.456	20	100	
With sound signal:			
907.458	20	162	
907.460	20	100	
Options:			
836.535	Spare battery (2 needed)		
497.931	Spare battery		

TECHNOBEARING

907.456

907.458

3D probes for centering and measuring

For easy and with high accurate setting the reference point of workpiece in all three axes (X, Y and Z), vertically and horizontally.

- Measuring range: max. ±2 mm (rupture point in probe).
- Analog: graduation 0.01 mm, digital: resolution 0.001 mm.
- Clamping stem: $\varnothing 20$ mm.
- Insert length 25 mm, stylus tip $\varnothing 4$ mm (insert length 65 mm and diameter 8 mm optional).
- mm/inch conversion (only 853.822).
- Digit height: 8.5 mm (only 853.822).
- Isolation between insert and insert thread; for use on all machining centres and EDM machines.
- Insert thread: M3.
- Protection:
analog: IP67,
digital: IP64.

TECHNOBEARING



Item No.	Description	Accuracy mm	Repeatability mm	Price RUB
853.821	Analog 3D probe	±0.01	0.01	
853.822	Digital 3D probe	±0.005	0.001	
Options:				
495.157	Spare battery			
853.823	Spare insert 25 mm, tip diameter 4 mm			
853.824	Spare insert 65 mm, tip diameter 8 mm			

Edge finders

Rotating edge finders for accurate edge location.

- Resolution: 0.005 mm.
- Repeatability: 0.005 mm.
- Range of use: 400-600 rpm.
- Hardness TiN measuring face: 2200 HV.



Item No.	Clamping stem \varnothing /mm	Probe \varnothing /mm	Material (measuring face)	Price RUB
909.360	8	10	steel	
909.361	10	10	steel	
909.362	8	4 and 10	steel	
909.363	10	4 and 10	steel	
909.364	6	6	steel	
909.365	10	10	steel + ceramic	
909.366	10	10	steel + TiN	
909.367	10	4 and 10	steel + TiN	
Options:				
909.368	Spring for 909.360/362			
909.369	Spring for 909.364			
909.359	Spring for 909.365			
909.349	Spring for 909.361/363/366/367			

003.317. Technobearing 201 (9628)

Z-axis setting gauge

For easy presetting the Z-axis with a tool, with or without in combination with parallel blocks to set a specific height. As soon as the tool touches the setting gauge (with floating top) the built-in red LED illumination will light up. After this the axis will move in opposite direction until the lamp turns off, this is the turning point, and so the setting gauge, to determine the accuracy.

- Repeatability: 0.01 mm.
- With magnetic base.
- Galvanic contact principle.



- Dimensions: $\varnothing 54 \times 50$ mm (precise height to determine with external measuring instrument).
- Weight: 450 g.
- Power supply: 2 batteries type V389.



Item No.	Description	Price RUB
908.804	Z-axis setting gauge	
Option:		
498.823	Spare battery (2 needed)	

Digital Z-axis setting gauge

For easy presetting the Z-axis with a tool, with or without in combination with parallel blocks to set a specific height.

- Graduation: 0.01 mm.
- Repeatability: 0.01 mm.
- With magnetic base.
- mm/inch conversion.



- On/off switch.
- Automatic switch-off.
- Height: 50 mm (precise height to determine with external measuring instrument).
- Weight: 377 g.
- Power supply: 1 battery type V357.
- Delivery with reference pin for insert in tool holder.

Item No.	Description	Price RUB
910.169	Z-axis setting gauge	
Option:		
836.535	Spare battery	

Z-axis setting gauge

For easy presetting the Z-axis with a tool, with or without in combination with parallel blocks to set a specific height.

- Graduation: 0.01 mm.
- Repeatability: 0.02 mm.
- With magnetic base.
- Diameter dial indicator: $\varnothing 35$ mm.



TECHNOBEARING

- Height: 50 mm (precise height to determine with external measuring instrument).
- Weight: 1013 g.
- Delivery with reference pin for insert in tool holder.



Item No.	Description	Price RUB
909.460	Z-axis setting gauge	

001.324 Technobearing 201 (9623)

Stands / Bench centers / Surface plates



Flatness tolerances according DIN 876		
Class	Flatness t_f (μm)	L = length in mm
00	$2 + L / 500$	
0	$4 + L / 250$	
1	$10 + L / 100$	
2	$20 + L / 50$	
3	$40 + L / 25$	

DOI.D10. Technobearing 201 (REG23)

Dial indicator stands

- With dovetail joint (only 908.958/972).
- With fine adjustment (except 908.958/974).
- On/off switchable magnetic base with V-groove, except 908.973 (*flexform* base with locking mechanism and permanent magnetic force) and 908.974 (flat on/off switchable magnetic base).
- Various bases available.



Item No.	Clamping shaft/mm	Column mm	Arm mm	Desc. of base	Dimensions l x w x h/mm	Magn. force ¹ /N	Thread of base	Price RUB
908.950	ø4/ø8	ø12 x 176	ø10 x 150	V-groove	58 x 50 x 55	600 ^(S)	M8 x 1.25	
908.951	ø4/ø8	ø12 x 176	ø10 x 150	V-groove	60 x 50 x 55	800 ^(S)	M8 x 1.25	
908.952	ø6/ø8	ø20 x 350	2 arms: ø12 x 220 ø10 x 150	V-groove	74 x 50 x 55	1000 ^(S)	M10 x 1.5	
908.958	ø8	ø8 x 130	ø8 x 130	V-groove	36 x 30 x 35	400 ^(S)	M5 x 0.8	
908.972	ø8	ø12 x 176	ø10 x 210	V-groove	60 x 50 x 55	800 ^(S)	M8 x 1.25	
908.973	ø4/ø8	ø12 x 176	ø10 x 150	<i>flexform</i>	75 x 46 x 55	400 ^(P)	M8 x 1.25	
908.974	ø6	ø7 x 50	ø10 x 150	flat	30 x 30 x 30	170 ^(S)	M5 x 0.8	
908.946 ²	ø8	ø12 x 190	ø10 x 160	V-groove	54 x 40 x 47	800 ^(S)	M8 x 1.25	

¹ S= switchable magnet; P=permanent magnetic force.

² V-groove on 3 sides.

Dial indicator stands

- Clamping shaft $\varnothing 8$ mm for dial indicators and probes, and dovetail joint for lever-type dial test indicators (908.957 without dovetail joint).
- With fine adjustment (except 908.962/964/957).
- Arm with mechanical central clamping device (908.954/955: hydraulic).
- On/off switchable magnetic base with V-groove, except 908.964 (permanent magnetic force), 908.961 (vacuum base) and 908.975 (*flexform* base with locking mechanism and permanent magnetic force).
- Various bases available.



Item No.	Clamping	Arm length ¹ /mm	Description of base	Dimensions l x w x h/mm	Magnetic force ² /N	Thread of base	Price RUB
908.953	mechanical	320	V-groove	58 x 50 x 55	600 ^(S)	M8 x 1.25	
908.959	mechanical	340	V-groove	60 x 50 x 55	800 ^(S)	M8 x 1.25	
908.960	mechanical	285	V-groove	60 x 50 x 55	800 ^(S)	M8 x 1.25	
908.954	hydraulic	380	V-groove	58 x 50 x 55	600 ^(S)	M8 x 1.25	
908.955	hydraulic	380	V-groove	60 x 50 x 55	800 ^(S)	M8 x 1.25	
908.962	mechanical	150	V-groove	36 x 30 x 35	400 ^(S)	M5 x 0.8	
908.964	mechanical	65	cylinder	$\varnothing 30 \times 25$	170 ^(P)	M8 x 1.25	
908.975	mechanical	280	<i>flexform</i>	75 x 46 x 55	400 ^(P)	M8 x 1.25	
908.961	mechanical	280	vacuum base	$\varnothing 90 \times 25$		M8 x 1.25	
908.956	mechanical	360	V-groove	60 x 50 x 55	800 ^(S)	M8 x 1.25	
908.957	mechanical	320	V-groove	60 x 50 x 55	800 ^(S)	M8 x 1.25	

¹ The outstretched length between base and clamping shaft.
² S=switchable magnet; P=permanent magnetic force.

001.DM Technobearing 2019/06/25

Bases for dial indicator stands

A solid base is essential for accurate measurements. The dial indicator arms can be mounted on a strong magnetic or vacuum base.



Item No.	Description	Dimensions l x w x h/mm	Magnetic force*/N	Thread	Price RUB
908.971	V-groove	60 x 50 x 55	800 ^(S)	M8 x 1.25	
908.970	V-groove	74 x 50 x 55	1000 ^(S)	M8 x 1.25	
908.969	flat base	118 x 50 x 52	1500 ^(S)	M8 x 1.25	
908.967	V-groove	36 x 30 x 35	400 ^(S)	M5 x 0.8	
908.976	flat base	30 x 30 x 30	170 ^(S)	M5 x 0.8	
908.968	flexform	75 x 46 x 55	400 ^(P)	M8 x 1.25	
908.965	cylinder	∅40 x 30	300 ^(P)	M8 x 1.25	
908.977	vacuum base	∅90 x 25		M8 x 1.25	
402.196	granite base	150 x 100 x 40		M8	

* S=switchable magnet; P=permanent magnetic force.

Fixing clamps for dial indicator stands

Item No.	Fixing clamp ∅/mm		Price RUB
	d1	d2	
907.443	10	8/4	
907.442	10	8/6	
906.398	12	8/6	
907.440	12	10	
907.444	14	8/6	
906.399	20	12	
907.441	20	14	



NEW

001.305 Technobearing 201 (94628)

Magnetic dial indicator stands

Solid dial indicator stands with on/off switchable magnetic base.

- Clamping shaft: $\varnothing 6$ and $\varnothing 8$ mm.
- Magnetic base with V-groove.
- Magnetic face at the back (except 855.707).



855.701



855.705



855.707

Item No.	Dimensions base l x w x h/mm	Magnetic force/N	Column mm	Arm mm	Thread of base	Price RUB
855.701	58 x 50 x 55	800	$\varnothing 12 \times 176$	$\varnothing 10 \times 150$	M8	
855.705	73 x 50 x 55	1000	$\varnothing 20 \times 178$	$\varnothing 14 \times 165$	M8	
855.707	117 x 50 x 55	1300	$\varnothing 20 \times 365$	$\varnothing 14 \times 200$	M20	

Magnetic dial indicator stands

Solid dial indicator stands with on/off switchable magnetic base.

- Clamping shaft: $\varnothing 6$ and $\varnothing 8$ mm.
- Screw thread base: M8.
- Magnetic base with V-groove.
- Magnetic face at the back.

TECHNOBEARING



855.706



855.710

Item No.	Clamping	Dimensions base l x w x h/mm	Magnetic force/N	Arm length* mm	Price RUB
855.706	hydraulic	73 x 50 x 55	1000	335	
855.710	mechanical	58 x 50 x 55	800	335	

*The outstretched length between base and clamping shaft.

Flexible hoses for coolant with magnetic base

- Suitable for cooling on machines in places of the workpiece that are difficult to reach.
- With 1, 2 or 3 flexible hoses.
- Special coupling for supply hose $\varnothing 8.5$ mm.

Support with magnetic base

- On/off switchable magnetic base with V-groove.
- Magnetic force: 588 N.
- Separate on/off switch for every flexible hose.
- Dimensions base $l \times w \times h$:
 906.213: 62 x 51 x 73 mm,
 906.214: 62 x 51 x 74 mm,
 906.215: 69 x 51 x 75 mm.

With round magnetic base

- Magnetic base $\varnothing 35$ mm, with high adhesive force.
- Metal protection plate under magnetic base.



906.213



906.214



906.215



906.216



906.217



906.218

Item No.	Number of flexible hoses	Price RUB
Support with magnetic base:		
906.213	1	
906.214	2	
906.215	3	

Item No.	Number of flexible hoses	Price RUB
With round magnetic base:		
906.216	1	
906.217	2	
906.218	3	

LED lamp on magnetic stand

- Total length: 215 mm.
- Magnetic force: 120 N.
- Power supply: 3 batteries type AAA.

Item No.	Description	Price RUB
909.607	LED lamp on magnetic stand	
Option:		
497.914	Spare battery (3 needed)	



TECHNOBEARING

014.213 Technobearing 201 (9623)

Measuring stands

- Clamping shaft: $\varnothing 8$ mm.
- Transverse arm with fine adjustment.
- Arm length: 150 mm.
- Ground base.
- Base with V-groove (only 857.120).



857.120



857.121

Item No.	Column \varnothing /mm	Dimensions base/mm	Effective arm length/mm	Price RUB
857.120	16	65 x 40 x 140	250	
857.121	22	60 x 55 x 250	300	

Measuring stand

- Clamping shaft: $\varnothing 8$ mm.
- Effective arm length: 180 mm.
- Fine adjustment.
- Ground base with V- and T-groove, 250x60x35 mm.
- Column: $\varnothing 16$ x 295 mm.
- Arm: $\varnothing 16$ x 235 mm.
- Mechanical clamping device.
- Dial indicator not included.

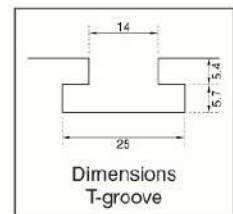

TECHNOBEARING

Item No.	Description	Price RUB
856.720	Measuring stand	

Measuring stands

- Clamping shaft: $\varnothing 8$ mm.
- Transverse arm with fine adjustment.
- Ground base with T-groove.
- Base with V-groove (only 909.376).

TECHNOBEARING



906.219



Item No.	Column mm	Arm mm	Dimensions base/mm	Price RUB
906.219	$\varnothing 14 \times 185$	$\varnothing 12 \times 245$	220 x 60 x 35	
909.376	$\varnothing 16 \times 290$	$\varnothing 16 \times 310$	260 x 60 x 50	

Measuring stand with spindle adjustment

Measuring stand with clear graduation 0.02 mm on the spindle and a hand wheel for easy adjustment of the height setting.

- Clamping shaft: $\varnothing 8$ mm.
- Spindle thread pitch: 2 mm.
- Column: $\varnothing 35$ mm.
- Transverse arm: $\varnothing 20$ mm.
- Granite measuring table: 260 x 150 x 50 mm, measuring face: 250 x 150 mm, flatness according DIN 876/00.
- Total height: 410 mm.
- Max. measuring height: 160 mm.
- Delivery in a wooden case.



Item No.	Description	Price RUB
907.789	Measuring stand	

001_3D1 Technobearing 201 (9625)

Measuring stand

Universal measuring stand, also suitable as a controlling measuring instrument.

- Clamping shaft \varnothing 8 mm and dovetail joint.
- Fine adjustment.
- Granite measuring table: 150 x 100 x 40 mm, flatness: $\leq 10 \mu\text{m}$.
- Base with groove in the center.
- Screw thread base: M8.
- Long, right side face with two mounting bores (thread M5, distance 120 mm).
- Mechanical clamping device.
- Arm length: 300 mm (the outstretched length between base and clamping shaft).
- Delivery in an aluminum case.



Item No.	Description	Price RUB
402.195	Measuring stand	

Measuring stand

- Clamping shaft: \varnothing 8 mm.
- Total height: 200 mm.
- Max. measuring height: 90 mm.
- Effective arm length: 80 mm.
- Measuring table: 60 x 68 mm, ground and lapped.
- Dimensions transverse arm: \varnothing 18 x 120 mm.
- Column: \varnothing 22 mm.
- Other dial gauge holders are available on request.



TECHNOBEARING



Item No.	Description	Price RUB
857.130	Measuring stand	

001.210. Technobearing 201 (9623)

Measuring stands

Universal measuring stands with a cast iron, ground measuring table.

- Clamping shaft: $\varnothing 8$ mm (optional available clamp with clamping shaft $\varnothing 28$ mm).
- Fine adjustment: 5 mm (906.506/508/516/518).
- Total height: 250 mm (906.508: 350 mm).
- Max. measuring height: 160 mm (906.508: 260 mm).
- Effective arm length: 68 mm (906.507: max. 105 mm, 906.517/519: max. 95 mm).
- Measuring table: ground, 906.506/507/508: flat anvil/base, 906.516/517: round flat anvil (height anvil: 13.5 mm), 906.518/519: round serrated anvil (height anvil: 13.5 mm).
- Flatness table: $\leq 10 \mu\text{m}$.
- Dimensions transverse arm: $\varnothing 20 \times 150$ mm (906.507/517/519).
- Column: $\varnothing 30 \times 200$ mm (906.508: helical threaded 300 mm with anti drop facility).



TECHNOBEARING



Item No.	Measuring height/mm	Dimensions table l x w x h/mm	Price RUB
906.506	140	140 x 105 x 50	
906.507	160	140 x 105 x 50	
906.508	260	140 x 105 x 50	
906.516	130	$\varnothing 60 \times 65$	
906.517	145	$\varnothing 60 \times 65$	
906.518	130	$\varnothing 60 \times 65$	
906.519	145	$\varnothing 60 \times 65$	

Option:
999.679 Clamp $\varnothing 28$ mm



001.310. Technobearing 201 (94623)

Measuring stands

Universal measuring stands with a granite measuring table.

- Clamping shaft: $\varnothing 8$ mm (optional available clamp with clamping shaft $\varnothing 28$ mm).
- Fine adjustment: 5 mm (999.680).
- Total height: 240 mm (999.680/681), 355 mm (999.682/683), 370 mm (999.684/685).
- Max. measuring height: 260 mm (999.682/683/684/685).
- Effective arm length: max. 165 mm (999.682/683/684/685), (999.681: max. 105 mm, 999.680: 68 mm).
- Measuring table: granite.
- Flatness table: $\leq 5 \mu\text{m}$ (999.684/685: delivery with an inspection report), $\leq 10 \mu\text{m}$ (999.680/681/682/683).
- Dimensions transverse arm: $\varnothing 20 \times 150$ mm (999.681), $\varnothing 20 \times 210$ mm (999.682/683/684/685).
- Column: $\varnothing 30 \times 200$ mm (999.680/681), $\varnothing 30 \times 300$ mm (999.682/684), $\varnothing 30 \times 300$ mm (999.683/685: helical threaded with anti drop facility).



001.311. Technobearing 201 (9623)

Measuring stands

Measuring stands with a granite base in two models with a competitive price-performance ratio.

- Clamping shaft: $\varnothing 8$ mm.
- Max. measuring height: 250 mm.
- Anti drop facility.
- Granite table.
- Own product.

TECHNOBEARING



Item No.	Measuring height/mm	Flatness table/ μm	Dimensions table $l \times w \times h$ /mm	Column \varnothing /mm	Effective arm length/mm	Price RUB
402.165	150	10	150 x 100 x 40	25	62	
402.168	250	10	250 x 200 x 55	35	100	

Measuring stand

Heavy-duty precision stand with alumina ceramic grooved table and plain column.

- Clamping shaft: $\varnothing 8$ mm.
- Max. measuring height: 135 mm.
- Effective arm length: 62 mm.
- Measuring table: 80 x 80 x 22 mm.
- Flatness table: $\pm 2 \mu\text{m}$.
- Column: $\varnothing 25$ mm.
- Base: 150 x 89 x 37 mm.
- Anti drop facility.
- Own product.

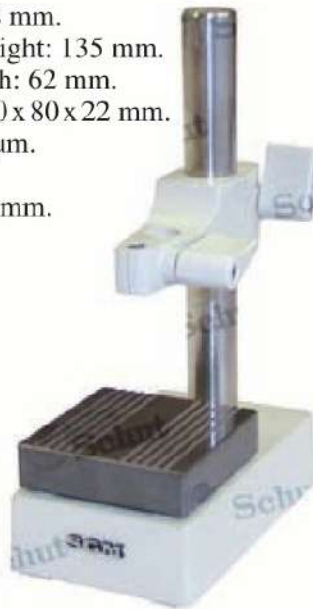

Measuring table

Grooved measuring table made of alumina ceramics as applied to measuring stand 334.690, with the typical advantages of ceramics: high degree of hardness and wear resistance.

- Flatness: $\pm 2 \mu\text{m}$.
- Dimensions: 80 x 80 x 22 mm.
- Bottom-side: 3 tapped holes M6.



Item No.	Description	Price RUB
334.690	Precision stand	

Item No.	Description	Price RUB
841.078	Measuring table	

001.272. Technobearing 201 (RUB)

Measuring stands

- Clamping shaft: $\varnothing 8$ mm.
- Total height: 310 mm.
- Max. measuring height: 180 mm.
- Hard-chrome plated and ground column: $\varnothing 35$ mm.
- 857.126 and 857.128 with adjustable transverse arm ($\varnothing 22$ mm), length 220 mm.
- Granite measuring table: 260x150x48 mm (*l x w x h*), measuring face: 200 x 150 mm, flatness according DIN 876/00.



Item No.	Column	Effective arm length/mm	Price RUB
857.125	plain	104	
857.126	plain	175	
857.127	helical threaded	104	
857.128	helical threaded	175	

Measuring stands

- Clamping shaft: $\varnothing 20$ mm or $\varnothing 32$ mm.
- Max. measuring height: 290 mm.
- Effective arm length: 167 mm.
- Column: $\varnothing 50$ mm.
- 996.190/315 with anti drop facility.
- Granite measuring table: 400 x 400 x 70 mm, flatness: $\leq 5 \mu\text{m}$.
- Delivery with an inspection report.
- DIN 876/0.
- Own product.



TECHNOBEARING

Item No.	Column	Clamping shaft/mm	Price RUB
996.190	plain	$\varnothing 20$	
996.189	helical threaded	$\varnothing 20$	
996.315	plain	$\varnothing 32$	

Option:
344.470 Reducing bush $\varnothing 20/8$ mm

001.213 Technobearing 201 (9625)

Bench center

Cast iron base with the measuring face's accuracy according DIN 876/1. Supplied with two tail-stocks, one with a fixed center point and one with an adjustable center point by means of a lever.

- Center height: 100 mm.
- Max. center distance: 450 mm.
- Center points: 60°.
- Stroke moveable center point: 8 mm.
- Delivery incl. measuring stand 857.141 (column $\varnothing 22 \times 230$ mm, clamping shaft 8H7, with fine adjustment), excl. dial indicator or measuring probe.
- Dimensions measuring face: 700x180 mm (incl. face for stand).
- Total height: 320 mm. (Height without stand: 200 mm.)
- Width T-slot: 12H7.
- Weight: 35 kg.

- Larger models with granite base are available on request.

Item No.	Type	Price RUB
857.131	RP 100-450	



Item No.	Description	Price RUB
857.179	Pair of center points with tungsten carbide point 60°	
857.178	Pair of center points with bore	
857.175	Pair of prism inserts	
857.136	Pair of V-blocks	
857.137	Pair of roller blocks	
857.176	Stop	
857.177	Dial indicator holder	
857.141	Extra measuring stand	

Center points ($\varnothing 22$ mm)

- With tungsten carbide point 60°, or with bore according DIN 332-A 1.6 x 3.8.



Prism inserts 90°

- Capacity: $\varnothing 8 - 45$ mm.
- Center height at $\varnothing 10$ mm: 130 mm.



V-blocks 90° and roller blocks

- Capacity V-blocks: $\varnothing 8 - 50$ mm.
- Capacity roller blocks: $\varnothing 2 - 60$ mm.
- Center height at $\varnothing 10$ mm: 100 mm.
- Stop (857.176): $\varnothing 8$ mm.
- Dial indicator holder (857.177): shaft 8H7.



Bench centers

Cast iron base with the measuring face's accuracy according DIN 876/1. Supplied with two tailstocks, one with a fixed center point and one with an adjustable center point by means of a lever.

- Center height: 50 mm (without V-shaped supports) or 75 mm (P models; with V-shaped supports on the tailstocks).
- Max. center distance: 200 or 350 mm.
- Center points: 60°.
- Capacity V-shaped supports: \varnothing 5 - 20 mm.
- Stroke moveable center point: 8 mm.
- Delivery incl. measuring stand 857.140 (column \varnothing 16 x 220 mm, clamping shaft 8H7, with fine adjustment), excl. dial indicator or measuring probe.
- Dimensions measuring face: 350 x 110 or 500 x 110 mm (including face for measuring stand).
- Total height (incl. measuring stand): 260 mm.
- Width T-slot: 10H7.
- Vertical models are also available.

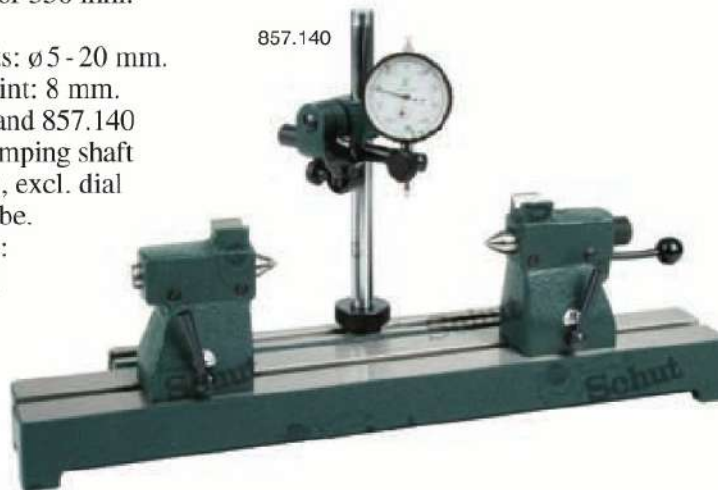

Item No.	Type	Center height mm	Max. center distance/mm	Measuring face/mm	Weight kg	Price RUB
857.132	RP 50-200	50	200	350 x 110	8	
857.133	RP 75-200P	75	200	350 x 110	9	
857.134	RP 50-350	50	350	500 x 110	11	
857.135	RP 75-350P	75	350	500 x 110	12	

Item No.	Description	Price RUB
857.174	Pair of center points with tungsten carbide point 60°	
857.155	Pair of center points with bore	
857.180	Pair of prism inserts	
857.138	Pair of V-blocks	
857.139	Pair of roller blocks	
857.172	Stop	
857.173	Dial indicator holder	
857.140	Extra measuring stand	

Center points (ø 16 mm)

- With tungsten carbide point 60°, or with bore according DIN 332-A 1.6 x 3.8.



Prism inserts 90°

- Capacity: \varnothing 3 - 15 mm.
- Center height at \varnothing 10 mm: 70 mm (RP 50) or 95 mm (RP 75).



V-blocks 90° and roller blocks

- Capacity V-blocks: \varnothing 5 - 25 mm.
- Capacity roller blocks: \varnothing 2 - 40 mm.
- Center height at \varnothing 10 mm: 65 mm.
- Stop (857.172): \varnothing 8 mm.
- Dial indicator holder (857.173): shaft 8H7.



857.138

TECHNOBEARING

001.222 Technobearing 201 (RUB)

Granite surface plates

Black granite surface plates according to DIN 876 specifications. Sizes vary from 250 x 250 mm to 2000 x 1000 mm.

- Delivery with an inspection report.
- Straight beveled edges.
- Cover (synthetic leather) optionally available.
- Surface plate stand optionally available (see “surface plate accessories” elsewhere in this catalog).



402.252



TECHNOBEARING

131.100 +
402.028

Delivery ex Groningen, Netherlands

Granite plate cleaner

Special granite plate cleaner to keep the surface of your granite surface plate clean and useable for a long period. Dust, dirt, grease stains, finger and hand prints can easily be removed. A clean and smooth surface provides low friction, less wear and the most accurate measurements. The non-corrosive property of the cleaner prevents corrosion damage to metal products.



Item No.	Description	Price RUB
407.304	Cleaner, 500 ml	

Dimensions <i>l x w x h</i> mm	Weight ¹ kg	Accuracy according DIN 876/1		Accuracy according DIN 876/0		Accuracy according DIN 876/00		Cover ²	
		Item No.	Price RUB	Item No.	Price RUB	Item No.	Price RUB	Item No.	Price RUB
250 x 250 x 50	13	402.000		402.020		402.040		402.250	
400 x 250 x 50	20	402.001		402.021		402.041		402.251	
400 x 400 x 70	41	402.002		402.022		402.042		402.252	
630 x 400 x 70	65	402.003		402.023		402.043		402.253	
630 x 630 x 80	108	402.004		402.024		402.044		402.254	
800 x 500 x 100	136	402.005		402.025		402.045		402.255	
900 x 600 x 100	188	402.006		402.026		402.046		402.256	
1000 x 630 x 100	223	402.007		402.027		402.047		402.257	
1000 x 630 x 150	317	402.008		402.028		402.048		402.257	
1000 x 1000 x 100	342	402.009		402.029		402.049		402.258	
1000 x 1000 x 150	504	402.010		402.030		402.050		402.258	
1200 x 800 x 120	394	402.011		402.031		402.051		402.259	
1200 x 800 x 150	467	402.012		402.032		402.052		402.259	
1500 x 1000 x 150	750	402.013		402.033		402.053		402.260	
1500 x 1000 x 200	971	402.014		402.034		402.054		402.260	
2000 x 1000 x 200	1295	402.015		402.035		402.055		402.261	
2000 x 1000 x 250	1600	402.016		402.036		402.056		402.261	

¹ Weight including wooden packing.

² Dimensions of the covers are equal to the length and the width of the surface plate, all covers have a depth of 50 mm.

Cast iron surface plates

Extra heavy, cast iron surface plates.

- Three models:
 - milled (smoothened), accuracy according DIN 876/3,
 - hand scraped, accuracy according DIN 876/1,
 - fine scraped, accuracy according DIN 876/0.
- The side faces of all plates are milled and varnished.
- Surface plate stand optionally available
(see “surface plate accessories” elsewhere in this catalog).

TECHNOBEARING



403.212

Delivery ex Groningen, Netherlands

Dimensions <i>l x w</i> mm	Weight kg (approx.)	Accuracy according DIN 876/3		Accuracy according DIN 876/1		Accuracy according DIN 876/0	
		Item No.	Price RUB	Item No.	Price RUB	Item No.	Price RUB
200 x 200	7	403.236		403.208		403.185	
250 x 250	12	403.237		403.209		403.186	
300 x 300	15	403.238		403.210		403.187	
400 x 250	25	403.239		403.211		403.188	
400 x 400	35	403.240		403.212		403.189	
500 x 500	50	403.241		403.213		403.190	
600 x 400	45	403.242		403.214		403.191	
630 x 630	90	403.243		403.215		403.192	
800 x 500	95	403.249		403.221		403.193	
1000 x 600	140	403.245		403.217		403.194	
1000 x 1000	270	403.246		403.218		403.195	
1200 x 800	300	403.250		403.222		403.196	
1500 x 1000	650	403.247		403.219		403.197	
2000 x 1000	1000	403.248		403.220		403.198	

Surface plate supports

- For use with large granite or cast iron surface plates with a minimum size of 1000 x 630 mm.
- Support adjustable in height, with adjusting bolt and lock nut.
- For granite and cast iron surface plates it is advisable to use 5 surface plate supports, 3 for the Bessel points and 2 for tilt protection or a set of 5 supports, consisting of 3 surface plate supports and 2 sleeping points.

- Delivery incl. adjusting bolt and lock nut, excl. required supporting cup.

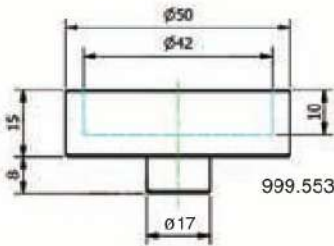

NEW

Delivery ex Groningen, Netherlands



403.298 + 999.553 (5 pieces) + 997.343

Item No.	Description	Height/mm		Price RUB
		min. ¹	max. ¹	
403.253	Surface plate support	550	580	
403.254	Surface plate support	650	680	
403.298 ²	Set of 5 supports	550	580	
403.299 ²	Set of 5 supports	650	680	
999.553 ³	Supporting cup (per piece)			
997.343 ⁴	Support set			

¹ Height without supporting cup and supporting set (incl. adjusting bolt and lock nut).

² Set consists of 3 supports and 2 tilt protectors.

³ Required for granite and cast iron surface plates.

⁴ Required for granite surface plates (in combination with supporting cups).



Support with supporting cup and supporting set.



Sleeping point with supporting cup and supporting set.

Support set for surface plates

Support set for placing a small surface plate on a working table.

- Set consists of support based on 3 Bessel points and two tilt protectors.

- Stainless steel construction.
- Diameter: 40 mm.

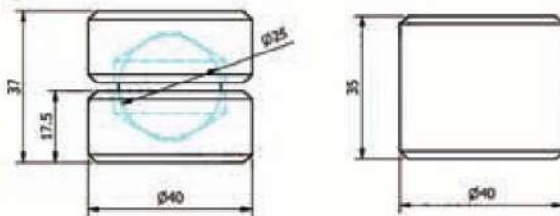

Item No.	Description	Price RUB
997.343	Support set	



Surface plate stands

Extremely solid surface plate stands with excellent price-performance ratio. Support of the surface plate is determined on the basis of the bessel points and has an optional slide protection and chest of drawers. Working height is depending on the surface plate thickness. The models for surface plates equal to or larger than 1000 x 1000 mm directly bear the load at the bessel points to the floor.

- Delivered incl. support (bessel) and sleeping points.
- Difference min. and max. height incl. surface plate: 25 mm.
- Delivered in color RAL 7035.
- Custom made is optionally available.



131.101 +
131.113 +
131.108 +
402.028

Delivery ex Groningen, Netherlands



131.100 +
402.028

TECHNOBEARING



Sleeping point.



Bessel point.

Options

Item No.	For granite surface plates dimensions l x w x t/mm	Height incl. surface plate min./mm max./mm		Price RUB
Surface plate stand (standard model):				
131.100 ¹	630x 630x 80	880	905	
131.100 ¹	800x 500x 100	900	925	
131.100 ¹	900x 600x 100	900	925	
131.100 ¹	1000x 630x 100	900	925	
131.100 ¹	1000x 630x 150	950	975	
131.104	2000x 1000x 200	850	875	
131.104	2000x 1000x 250	900	925	
Surface plate stand (prepared for chest of drawers):				
131.101 ¹	630x 630x 80	880	905	
131.101 ¹	800x 500x 100	900	925	
131.101 ¹	900x 600x 100	900	925	
131.101 ¹	1000x 630x 100	900	925	
131.101 ¹	1000x 630x 150	950	975	
131.102	1000x 1000x 100	850	875	
131.102	1000x 1000x 150	900	925	
131.102	1200x 800x 120	870	895	
131.102	1200x 800x 150	900	925	
131.103	1500x 1000x 150	850	875	
131.103	1500x 1000x 200	900	925	

¹ Does not directly bear the load to the floor at the bessel points.

² Incl. fasteners.

³ Sleeping 2 and bessel points 3 needed.

Item No.	For granite surface plates dimensions l x w x t/mm	Price RUB
Slide protection² for surface plate stands:		
131.105	630x 630x 80	
131.106	800x 500x 100	
131.107	900x 600x 100	
131.108	1000x 630x 100/150	
131.109	1000x 1000x 100/150	
131.110	1200x 800x 120/150	
131.111	1500x 1000x 150/200	
131.112	2000x 1000x 200/250	
Bessel and sleeping points:		
131.115 ³	Sleeping point (tilt protection) (height: 30 mm higher than standard)	
131.116 ³	Bessel point (height: 30 mm higher than standard)	
Chest of drawers:		
131.113 ²	Chest of drawers (RAL 5015), incl. fasteners, 610 x 480 x 470 mm (w x d x h); 3 drawers. Inside dimensions drawers (w x d x h): upper drawer: 515 x 395 x 90 mm, middle drawer: 515 x 395 x 105 mm, lower drawer: 515 x 395 x 135 mm.	

001.009 Technobearing 201 (RUB)

**V-blocks / Vises / Angle plates / Cylindrical squares
Squares / Parallels / Straight edges**



Flatness tolerances according DIN 874	
Class	Flatness t_1 (μm)
00	$1+L/150$
0	$2+L/100$
1	$4+L/60$
2	$8+L/40$

Squareness tolerances according DIN 875	
Class	Squareness (μm)
00	$2+L/100$
0	$5+L/50$
1	$10+L/20$
2	$20+L/10$

Flatness tolerances according DIN 876	
Class	Flatness t_1 (μm)
00	$2+L/500$
0	$4+L/250$
1	$10+L/100$
2	$20+L/50$
3	$40+L/25$

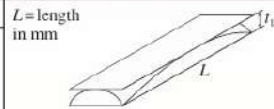

D07.D00 Technobearing 201 (REV2)

V-blocks in pairs

V-blocks for clamping, processing, aligning and inspecting cylindrical objects, available in three classes.

- **Class 3:** Parallelism: 60 µm.
Base and prism face smooth planed, short and long side processed.
- **Class 1:** Parallelism: 16 µm.
Base and prism face hand scraped, short and long side processed.
- **Class 0:** Parallelism: 8 µm.
Base and prism face and short side fine scraped, long side processed.
- Ground in matched pairs.
- V-groove: 90°.



Dimensions <i>l x w x h</i> mm	Capa- city ø/mm	Weight p. pair kg	Class 3		Class 1		Class 0	
			Item No.	Price RUB p. pair	Item No.	Price RUB p. pair	Item No.	Price RUB p. pair
Steel:								
100 x 40 x 30	6 - 50	1.4	403.396		403.390		403.380	
150 x 50 x 40	8 - 60	3.6	403.397		403.391		403.381	
High-quality gray cast iron:								
200 x 70 x 50	8 - 75	6.1	403.398		403.392		403.382	
250 x 85 x 60	10 - 100	10	403.399		403.395		403.383	
300 x 100 x 70	15 - 120	15	403.400		403.393		403.384	

X-blocks in pairs

The X-blocks have four V-grooves of 90°, all varying in size.

- **Class 1:** Parallelism: 16 µm.
Flatness of the measuring faces according DIN 876/1.
All surfaces hand scraped.
- **Class 0:** Parallelism: 8 µm.
Flatness of the measuring faces according DIN 876/0.
All surfaces fine scraped.
- All four V-grooves are ground in matched pairs.
- Material: high-quality gray cast iron.
- V-groove: 90°.
- Holds workpieces on all faces.



Dimensions <i>l x w x h</i> mm	Capa- city ø/mm	Weight p. pair kg	Class 1		Class 0	
			Item No.	Price RUB p. pair	Item No.	Price RUB p. pair
120 x 100 x 60	8 - 90	6	403.370		403.360	
150 x 130 x 75	8 - 110	10.4	403.371		403.361	
200 x 170 x 90	8 - 150	25	403.372		403.362	

TECHNOBEARING

Magnetic V-blocks

- Accuracy: ± 0.02 mm / 100 mm.
- On/off switch.
- V-groove: 90° .



Item No.	Dimensions <i>l x w x h</i> /mm	Capacity ϕ /mm	Magnetic force/N	Weight kg	Price RUB
906.207	70 x 60 x 72	8 - 50	686	1.8	
906.208	100 x 70 x 95	6 - 55	1178	3.7	



Magnetic V-blocks

- Magnetic force: 200 N.
- Ground in matched pairs.
- V-groove: 90° .
- Weight: 2.2 kg (per piece).



Item No.	Dimensions <i>l x w x h</i> /mm	Capacity ϕ /mm	Price RUB
906.210	100 x 50 x 80	6 - 70	



Magnetic V-block

- V-groove: 90° .
- Magnetic force of round spindle axis in V-groove: 450 N, magnetic force of base plate: 450 N.

TECHNOBEARING

Item No.	Dimensions <i>l x w x h</i> /mm	Capacity ϕ /mm	Price RUB
855.200	125 x 60 x 73	6 - 50	



Adjustable V-blocks

V-blocks adjustable from 0 to +60 degrees and 0 to -15 degrees. Suitable for metal cutting machines and for various measuring purposes.



Item No.	Dimensions l x w x h/mm	Price RUB
906.600	75 x 25 x 32.5	
906.601	102 x 30 x 48	
906.602	102 x 46 x 48	

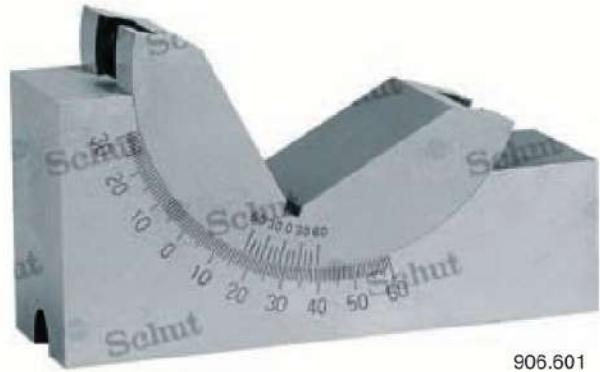

906.601

V-blocks in pairs

- Parallelism measuring faces: $\pm 4 \mu\text{m}$.
- Squareness of front face with bottom face according DIN 2274.
- Hardened ($650 \pm 100 \text{ HV5}$).
- Ground in matched pairs.
- V-groove: 90° .
- Delivery incl. clamp.

V-blocks in pairs

- Parallelism measuring faces: $\pm 4 \mu\text{m}$.
- Squareness of all side faces with each other according DIN 2274.
- Hardened ($650 \pm 100 \text{ HV5}$).
- Ground in matched pairs.
- V-groove: 90° .
- Delivery incl. clamp.



666.550

TECHNOBEARING



666.540

Item No.	Dimensions l x w x h/mm	Capacity ϕ /mm	Price RUB
666.550	50 x 40 x 40	5 - 30	
666.551	75 x 55 x 55	5 - 50	
666.552	100 x 75 x 75	7 - 70	

Item No.	Dimensions l x w x h/mm	Capacity ϕ /mm	Price RUB
666.540	60 x 58 x 40	5 - 30	
666.541	75 x 70 x 54	5 - 50	
666.542	100 x 96 x 75	7 - 70	

007.203 Technobearing 201 (06/23)

Granite V-blocks in pairs

- V-groove: 90°.
- Material: granite.
- Processed in matched pairs.
- Delivery in a aluminum case (except 402.158/162).
- Delivery with an inspection report.



Dimensions <i>l x w x h</i> /mm	Capacity ϕ /mm	Weight kg ¹	Item No.	Accuracy μm^2	Price RUB	Item No.	Accuracy μm^2	Price RUB
			Class 1:			Class 0:		
63 x 63 x 63	10- 50	1.4	402.155	± 6		402.159	± 3	
100 x 100 x 100	15- 75	5.6	402.156	± 8		402.160	± 4	
100 x 160 x 160	25- 125	14.2	402.157	± 8		402.161	± 4	
160 x 250 x 250	60- 200	55.2	402.158	± 10		402.162	± 5	

¹ Weight per pair.

² Parallelism between measuring faces and base.

Magnetic induction blocks in pairs

These magnetic induction blocks are not magnetized themselves. They are placed on a magnetic chuck to induce, to hold objects as for example round bars.



Item No.	Dimensions <i>l x w x h</i> /mm	Weight kg	Price RUB
909.377	100 x 50 x 25	1.18	
909.378	50 x 60 x 48	1.13	

- Material: steel and aluminum alloy.
 - Ground in matched pairs.
- V-blocks (909.378)**
- Capacity: $\phi 7 - 50$ mm.
 - V-groove: 90°.



Magnetic holders

- Angles 45°, 90° and 135°.

Item No.	Dimensions <i>h x w</i> /mm	Thickness mm	Holding power/kg	Price RUB
909.342	80 x 120	14	2.5	
909.332	100 x 155	17	8	

Precision clamping tools

Miniature clamping tools for clamping of small products. Very well suited for measuring for example with roughness testers, microscopes or measuring machines.

Precision vises

- Accuracy (parallelism, flatness and squareness): 0.02 mm.
- 856.081: brass, matt chrome-plated; 856.082 and 856.083: aluminum, matt anodized.
- Standard supplied with 2 pairs of jaws (hardened stainless steel and plastic): 1 side with a ground horizontal and vertical prism and 1 flat side.
- 856.081 and 856.082: provided with 2 x M4 threaded bores with center distances 42 and 62.5 mm; 856.083: provided with 2 x M6 threaded bores with center distance approx. 83 mm.

Clamp jaw sets

Sets consisting of 1 pair plastic jaws, 1 pair with stepped jaws and 1 jaw with a stopper in the horizontal prism.

Base plates

For mounting of the precision vises using a central M6 threaded bore.



Item No.	Jaw opening mm	Jaw width mm	Jaw depth mm	Length mm	Weight kg	Price RUB
856.081	14	15	8	50	0.075	
856.082	23	25	15	75	0.16	
856.083	32	35	21	100	0.4	

Options

Item No.	Description	Price RUB
Clamp jaw sets:		
856.084	For 856.081	
856.085	For 856.082	
856.086	For 856.083	
Base plates:		
856.087	For 856.081	
856.088	For 856.082	
856.089	For 856.083	



NEW



Indexable collet

- Clamping range: 0.4 - 6 mm.
- Per approx. 45 degrees indexable.
- Aluminum, blasted.

- Mounting by means of two M6 threaded bores on the bottom-side.



Item No.	Clamping range mm	Dimensions l x w x h/mm	Price RUB
856.090	0.4 - 3.5	26 x 21 x 34	
856.091	1.2 - 6	26 x 26 x 39	

NEW

Precision vises

Hardened precision vises for accurate measurements and machine operations.

- Accuracy (parallelism, flatness and squareness):
 ≤ 100 mm jaw opening = 0.005 mm,
 > 100 mm jaw opening = 0.005 mm per 100 mm.
- With horizontally and vertically ground prism in the moveable jaw.

Precision and universal sine vises

- Stable and accurate to fix in each angle position (0 to 45°).

Universal precision vise

- With 360° rotatable base.
- Accurate degree scale.
- Stable and accurate to fix in each angle position (0 to 45°).



909.734



909.739



909.746



909.749



909.752



Item No.	Jaw opening mm	Jaw width mm	Jaw depth mm	Length mm	Price RUB
Precision vises:					
909.733	60	50	25	150	
909.734	80	75	35	200	
909.735	120	100	45	250	
909.736	155	125	50	300	
Precision sine vises with swivelling front axis:					
909.737	25	25	10	65	
909.738	65	50	25	140	
909.739	100	75	35	190	
909.740	120	100	45	240	
909.741	155	125	50	280	
Precision sine vises with swivelling rear axis:					
909.742	60	50	25	140	
909.743	100	75	35	190	
909.744	120	100	45	250	
Universal sine vises:					
909.748	60	50	25	140	
909.749	100	75	35	200	
909.750	120	100	45	250	
909.751	155	125	50	300	
Universal precision vise:					
909.752	80	70	30	-	

TECHNOBEARING

007_3D9 Technobearing 201 (RUB25)

Modular precision vises

Hardened precision vises for fixation for various machine operations.

- With or without 90° rotatable base.
- Accuracy (parallelism, flatness and squareness):
 - ≤ 100 mm jaw opening = 0.005 mm,
 - > 100 mm jaw opening = 0.005 mm per 100 mm.
- Also available:
 - intermediate sizes with other jaw depths and jaw openings,
 - larger models with jaw width 200 or 300 mm and jaw opening up to 600 mm.



909.702



909.706

TECHNOBEARING

Jaw opening mm	Jaw width mm	Jaw depth mm	Length mm	Without rotatable base		With rotatable base	
				Item No.	Price RUB	Item No.	Price RUB
100	100	30	270	909.702		909.706	
150	125	40	345	909.703		909.707	
200	150	50	420	909.704		909.708	
400	175	60	655	909.705		909.709	



Long modular vises

Long hardened vises for fixation for various machine operations.

- Single or two-sided model.
- Also available:
 - intermediate sizes with other jaw depths and jaw openings,
 - larger models with jaw width 200 mm and jaw opening up to 700 mm (single) or 250 mm (two-sided).



909.710



909.714



Jaw width mm	Jaw depth mm	Length mm	Single		Two-sided	
			Item No.	Jaw opening/mm Price RUB	Item No.	Jaw opening/mm Price RUB
100	30	460	909.710	290	909.714	90
125	40	520	909.711	320	909.715	100
150	50	580	909.712	360	–	–
150	50	680	–	–	909.716	160
175	60	866	909.713	600	909.717	220

007_310 Technobearing 201 (9625)

Short modular vises

Short hardened vises for fixation for various machine operations.

- With fixed jaw, fixed double jaw or moveable jaw.



909.723



909.728



909.718



Jaw width mm	Jaw depth mm	Length mm	Height mm	Fixed jaw		Fixed double jaw		Moveable jaw	
				Item No.	Price RUB	Item No.	Price RUB	Item No.	Price RUB
100	30	140	65	909.723		909.728		909.718	
125	40	160	80	909.724		909.729		909.719	
150	50	230	100	909.725		909.730		909.720	
175	60	240	118	909.726		909.731		909.721	
200	65	300	135	909.727		909.732		909.722	

Precision sine plates

- Stable and accurate to fix in each angle position (0 to 45°).

Precision sine plates

- Accuracy (parallelism and squareness):
 ≤ 100 mm dimension *l* or *w* = 0.005 mm,
 > 100 mm dimension *l* or *w* = 0.005 mm per 100 mm.
- Mounting hole pattern 909.690: 13x M5,
 909.691: 23x M5.

Magnetic precision sine plates

Permanently magnetic sine plates for positioning and holding small or odd-shaped workpieces.

- Center distance of the support cylinders:
 909.692: 76 mm,
 909.693: 127 mm.

TECHNOBEARING



909.690



909.692



Item No.	Dimensions/mm	Price RUB
Precision sine plates:		
909.690	100 x 100 x 50	
909.691	152 x 152 x 57	
Magnetic precision sine plates:		
909.692	100 x 100 x 117	
909.693	152 x 152 x 117	

007_311 Technobearing 2019 06/23

Granite square blocks with V-nut and tapped holes

Multifunctional granite blocks for e.g. flatness and squareness measurements, with V-nut and several tapped holes. Hold workpieces on several faces.

- Accuracy measuring faces:
flatness conforms to DIN 876/0,
squareness conforms to DIN 875/1.
- Screw thread of tapping holes:
402.170: M6, 402.171/172: M8.
- Equilateral cubic.

Item No.	Dimensions mm	Flatness μm	Squareness μm	Weight kg	Price RUB
402.170 ¹	160 x 160 x 160	4	8	9.6	
402.171	200 x 200 x 200	5	9	17	
402.172	250 x 250 x 250	5	10	34	

¹ Delivery with an inspection report.



402.170

Four-sided cast iron parallel blocks in pairs

Hollow but yet stable cast iron parallel blocks because of the internal bridge construction.

- **Class 3:** Parallelism: 64 μm . Smooth planed.
- **Class 1:** Parallelism: 16 μm . Hand scraped.
- **Class 0:** Parallelism: 8 μm . Fine scraped.
- Flatness conforms to DIN 876.
- Squareness conforms to DIN 875.
- Plan parallel and square matched in pairs.

TECHNOBEARING



403.622

Dimensions <i>l x w x h</i> /mm	Weight p. pair/kg	Class 3		Class 1		Class 0	
		Item No.	Price RUB	Item No.	Price RUB	Item No.	Price RUB
150 x 150 x 100	18	403.628		403.624		403.620	
200 x 150 x 100	28	403.629		403.625		403.621	
300 x 225 x 150	60	403.630		403.626		403.622	
400 x 300 x 200	140	403.631		403.627		403.623	

Cast iron angle blocks with several clamping possibilities

Cast iron angle block, with four clamping faces with several slots and taps, for aligning and clamping of tools and products. The four faces are planparallel and square matched.

- Slot width: 18 mm (403.607: 20 mm).

Item No.	Dimensions <i>l x w x h</i> /mm	Parallelism μm	Squareness μm	Weight kg	Price RUB
403.605	250 x 150 x 100	50	35	13	
403.606	300 x 200 x 150	52	40	23	
403.607	400 x 250 x 200	56	46	55	



403.606

Cast iron clamping tables with several clamping possibilities

These cast iron clamping tables offer many possibilities for aligning and clamping products for mechanical processing. The six faces are parallel and square milled. Four of these faces are equipped with several clamping slots and the top face with T-slots.

- Flatness according DIN 876/3.
- T-slots according DIN 650.



403.613

TECHNOBEARING

Item No.	Dimensions <i>l x w x h</i> /mm	Weight kg	Nom. value T-slots/mm	Slot width mm	Price RUB
403.610	250 x 180 x 150	25	14	16	
403.611	300 x 220 x 200	37	14	18	
403.612	350 x 280 x 250	70	22	22	
403.613	400 x 350 x 300	115	22	22	
403.614	500 x 450 x 400	180	22	22	
403.615	800 x 700 x 600	670	28	30	

Cast iron angle plates with several clamping slots

These cast iron angle plates have several clamping slots both in the base and the clamping face, which make them suitable for all kind of fixtures.

- Flatness according DIN 876.
- Squareness according DIN 875.
- Strengthened outsides.
- Slots in base and clamping face.



403.283

Item No.	Dimensions <i>l x w x h</i> /mm	Weight kg	Flatness and square- ness/ μ m	Slot width mm	Price RUB
Class 3, DIN 876/3, DIN 875/2:					
403.292	150 x 75 x 100	4	30	12	
403.293	200 x 100 x 150	8	30	14	
403.294	275 x 150 x 200	20	40	17	
403.295	300 x 150 x 250	24	45	19	
403.296	400 x 225 x 300	45	50	23	
403.297	500 x 300 x 400	85	60	23	
Class 1, DIN 876/2, DIN 875/1:					
403.286	150 x 75 x 100	4	15	12	
403.287	200 x 100 x 150	8	15	14	
403.288	275 x 150 x 200	20	20	17	
403.289	300 x 150 x 250	24	22	19	
403.290	400 x 225 x 300	45	25	23	
403.291	500 x 300 x 400	85	30	23	
Class 0, DIN 876/1, DIN 875/0:					
403.280	150 x 75 x 100	4	7	12	
403.281	200 x 100 x 150	8	7	14	
403.282	275 x 150 x 200	20	9	17	
403.283	300 x 150 x 250	24	11	19	
403.284	400 x 225 x 300	45	12	23	
403.285	500 x 300 x 400	85	15	23	

Cast iron angle plates

- Ground faces.
- With T-slots.
- Accuracy: flatness according DIN 876, squareness according DIN 875.

TECHNOBEARING



Dimensions <i>l x w x h</i> /mm	Weight kg	DIN 876/3 and 875/2 Item No. Price RUB	DIN 876/2 and 875/1 Item No. Price RUB	DIN 876/1 and 875/0 Item No. Price RUB
150x 75x 100	6	403.264	403.261	403.267
200x 100x 150	11	403.276	403.273	403.270
275x 150x 200	24	403.265	403.262	403.268
300x 150x 250	33	403.277	403.274	403.271
400x 225x 300	54	403.266	403.263	403.269
500x 300x 400	105	403.278	403.275	403.272

Steel cylindrical squares

Ground and lapped steel cylinder for checking squareness e.g. during the acceptance process of machines and instruments. Cylindricity error max. 1.5 μm .

Item No.	Dimensions mm	Squareness p-p/ μm	Price RUB
852.190	$\phi 90 \times 200$	2	
852.191	$\phi 90 \times 250$	2.2	
852.192	$\phi 90 \times 300$	2.5	
852.193	$\phi 90 \times 350$	2.8	
852.194	$\phi 90 \times 400$	3	



Steel cylindrical squares

Ground and lapped steel cylinder for checking squareness.

- Out of roundness, squareness and straightness: $\leq 5 \mu\text{m}$.
- Delivery with an inspection report.

Item No.	Dimensions mm	Squareness p-p/ μm	Price RUB
906.436	$\phi 80 \times 200$	3	
906.437	$\phi 80 \times 315$	4	
906.438	$\phi 100 \times 500$	5	
906.439	$\phi 140 \times 800$	7	



Granite squares

- Triangular model.
- Material: granite.
- Straight beveled edges.

- With weight-saving holes (except 402.120/126).
- Delivery in an aluminum case with an inspection report.



Item No.	Dimensions <i>h x w x t</i> /mm	Squareness ¹ μm	Flatness ² μm	Weight kg	Price RUB
DIN 875/0:					
402.120	100 x 63 x 16	±4	2	0.3	
402.121	160 x 100 x 20	±4	2	0.8	
402.122	250 x 160 x 25	±5	2	2.4	
402.123	400 x 250 x 40	±7	2.5	7.5	
402.124	630 x 400 x 63	±9	3	25.5	
402.125 ³	1000 x 630 x 80	±12	5	102	
DIN 875/00:					
402.126	100 x 63 x 16	±2	1	0.3	
402.127	160 x 100 x 20	±2	1	0.8	
402.128	250 x 160 x 25	±2.5	1	2.4	
402.129	400 x 250 x 40	±3.5	1.2	7.5	
402.130	630 x 400 x 63	±4.5	1.5	25.5	
402.131 ³	1000 x 630 x 80	±6	2.5	102	

¹ Squareness between measuring face and base.

² Flatness of measuring face and base.

³ Weight included package.

Granite squares

- Square model.
- Material: granite.
- Straight beveled edges.
- With weight-saving holes.

- Delivery in an aluminum case with an inspection report.

Item No.	Dimensions <i>h x w x t</i> /mm	Squareness μm ¹	Weight kg	Price RUB
Class 0:				
402.145	200 x 200 x 25	±4	2.6	
402.146	250 x 250 x 30	±4.5	4.9	
402.147	315 x 315 x 30	±5.2	7.7	
402.148	400 x 400 x 40	±6	14.5	
402.149	500 x 500 x 50	±7	33	
Class 00:				
402.150	200 x 200 x 25	±2	2.6	
402.151	250 x 250 x 30	±2.2	4.9	
402.152	315 x 315 x 30	±2.6	7.7	
402.153	400 x 400 x 40	±3	14.5	
402.154	500 x 500 x 50	±3.5	33	

¹ Squareness between adjacent measuring faces.



Flat steel squares

- Lapped measuring faces.
- Accuracy according DIN 875.

TECHNOBEARING



670.003

Item No.	Dimensions mm	Cross- section/mm	Price RUB
Class III:			
670.061	100 x 70	20 x 5	
670.065	300 x 175	35 x 7	
670.066	400 x 200	35 x 7	
670.067	500 x 250	40 x 8	
670.068	600 x 300	40 x 8	
DIN 875/2:			
670.041	75 x 50	15 x 5	
670.042	100 x 70	20 x 5	
670.043	150 x 100	25 x 5	
670.044	200 x 130	30 x 6	
670.045	250 x 165	35 x 7	
670.046	300 x 175	35 x 7	
670.047	400 x 200	35 x 7	
670.048	500 x 250	40 x 8	
670.049 ¹	600 x 300	40 x 8	
670.051 ^{1,2}	1000 x 500	50 x 10	

Item No.	Dimensions mm	Cross- section/mm	Price RUB
DIN 875/1:			
670.022	75 x 50	15 x 5	
670.023	100 x 70	20 x 5	
670.024	150 x 100	25 x 5	
670.025	200 x 130	30 x 6	
670.026	250 x 165	35 x 7	
670.027	300 x 200	40 x 8	
670.028	400 x 265	45 x 10	
670.029	500 x 330	50 x 10	
670.030 ¹	600 x 400	50 x 10	
DIN 875/0 (with inspection report):			
670.002	75 x 50	15 x 5	
670.003	100 x 70	20 x 5	
670.004	150 x 100	25 x 5	
670.005	200 x 130	30 x 6	
670.006	250 x 165	35 x 7	
670.007	300 x 200	40 x 8	
670.008	400 x 265	45 x 10	
670.009	500 x 330	50 x 10	

¹ Incl. transport package.

² Delivery ex Groningen, Netherlands.

Flat stainless steel squares

Item No.	Dimensions mm	Cross-section/mm	Price RUB
DIN 875/2:			
670.142	75 x 50	15 x 5	
670.143	100 x 70	20 x 5	
670.144	150 x 100	25 x 5	
670.145	200 x 130	30 x 6	
670.146	250 x 165	35 x 7	
670.147	300 x 200	35 x 7	
DIN 875/1:			
670.122	75 x 50	15 x 5	
670.123	100 x 70	20 x 5	
670.124	150 x 100	25 x 5	
670.125	200 x 130	30 x 6	
670.126	250 x 165	35 x 7	
670.127	300 x 200	40 x 8	
670.128	400 x 265	45 x 10	
670.129	500 x 330	50 x 10	
670.130 ¹	600 x 400	50 x 10	
DIN 875/0, hardened (with inspection report):			
670.751	50 x 40	12 x 5	
670.752	75 x 50	15 x 5	
670.753	100 x 70	20 x 5	
670.754	150 x 100	25 x 5	
670.755	200 x 130	30 x 6	
670.758	250 x 165	35 x 7	
670.759	300 x 200	40 x 8	
670.760	400 x 265	45 x 10	
670.761	500 x 330	50 x 10	

- Hardened stainless steel.
- Lapped measuring faces.
- Accuracy according DIN 875.



670.753

¹ Incl. transport package.

Wooden cases for squares

Wooden cases for flat squares.



670.466

TECHNOBEARING

Item No.	Dimensions square/mm	Price RUB
670.463	50 x 40	
670.464	50 x 40 / 75 x 50	
670.465	100 x 70	
670.466	150 x 100	
670.467	200 x 130	
670.468	250 x 165	
670.468	300 x 200	
670.469	400 x 265	
670.470	500 x 330	

Flat stainless steel squares

- Hardened stainless steel.
- Lapped measuring faces.
- Accuracy according DIN 875.

Item No.	Dimensions mm	Cross- section/mm	Price RUB
DIN 875/1:			
907.301	75 x 50	15 x 5	
907.302	100 x 70	20 x 5	
907.303	150 x 100	25 x 5	
907.304	200 x 130	30 x 6	
907.305	250 x 160	35 x 7	
907.306	300 x 200	40 x 8	
DIN 875/0:			
907.282	50 x 40	12 x 3.5	
907.283	75 x 50	15 x 5	
907.284	100 x 70	20 x 5	
907.285	150 x 100	25 x 7	
907.286	200 x 130	30 x 7	



907.284

PRICE

Flat steel squares

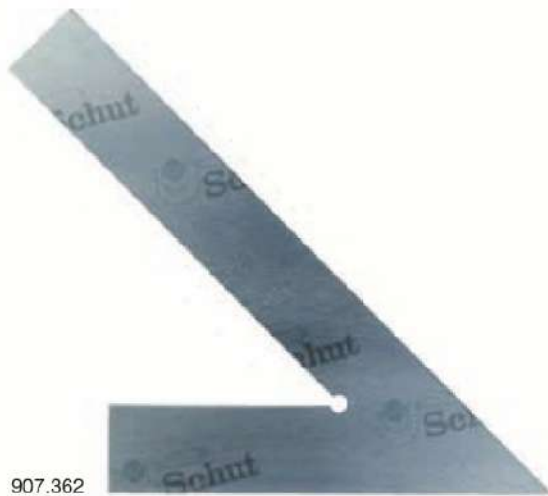

907.362



907.409

Item No.	Dimensions mm	Cross- section/mm	Price RUB
Acute angle squares 45°, DIN 875/2:			
907.359	100 x 70	20 x 5	
907.360	120 x 80	20 x 5	
907.361	150 x 100	20 x 5	
907.362	200 x 130	25 x 5	
Acute angle squares 60°, DIN 875/2:			
907.383	100 x 70	20 x 5	
907.384	120 x 80	20 x 5	
907.385	150 x 100	20 x 5	
907.386	200 x 130	25 x 5	
Hexagon squares 120°, DIN 875/2:			
907.407	50 x 50	15 x 5	
907.408	75 x 75	18 x 5	
907.409	100 x 100	20 x 5	
907.410	150 x 150	25 x 5	
907.411	200 x 200	30 x 6	
Octagon squares 135°, DIN 875/2:			
907.417	50 x 50	15 x 5	
907.418	75 x 75	18 x 5	
907.419	100 x 100	20 x 5	
907.420	150 x 150	25 x 5	
907.421	200 x 200	30 x 6	

PRICE

Steel squares with base

- Lapped measuring faces.
- Accuracy according DIN 875.

TECHNOBEARING



670.203

Item No.	Dimensions mm	Cross- section/mm	Price RUB
Class III:			
670.264	250 x 165	35 x 7	
670.265	300 x 175	35 x 7	
670.267	500 x 250	40 x 8	
670.268	600 x 300	40 x 8	
670.270 ²	1000 x 500	50 x 10	
DIN 875/2:			
670.241	75 x 50	15 x 5	
670.242	100 x 70	20 x 5	
670.243	150 x 100	25 x 5	
670.244	200 x 130	30 x 6	
670.245	250 x 165	35 x 7	
670.246	300 x 175	35 x 7	
670.247	400 x 200	35 x 7	
670.248	500 x 250	40 x 8	
670.249 ¹	600 x 300	40 x 8	
670.250 ¹	750 x 375	45 x 10	
670.251 ^{1,2}	1000 x 500	50 x 10	

Item No.	Dimensions mm	Cross- section/mm	Price RUB
DIN 875/1:			
670.222	75 x 50	15 x 5	
670.223	100 x 70	20 x 5	
670.224	150 x 100	25 x 5	
670.225	200 x 130	30 x 6	
670.226	250 x 165	35 x 7	
670.227	300 x 200	40 x 8	
670.228	400 x 265	45 x 10	
670.229	500 x 330	50 x 10	
670.230 ¹	600 x 400	50 x 10	
DIN 875/0 (with inspection report):			
670.202	75 x 50	15 x 5	
670.203	100 x 70	20 x 5	
670.204	150 x 100	25 x 5	
670.205	200 x 130	30 x 6	
670.206	250 x 165	35 x 7	
670.207	300 x 200	40 x 8	
670.208	400 x 265	45 x 10	
670.209	500 x 330	50 x 10	

¹ Incl. transport package.

² Delivery ex Groningen, Netherlands.

Stainless steel squares with base

Item No.	Dimensions mm	Cross-section/mm	Price RUB
DIN 875/2:			
670.342	75 x 50	15 x 5	
670.343	100 x 70	20 x 5	
670.344	150 x 100	25 x 5	
670.345	200 x 130	30 x 6	
670.346	250 x 165	35 x 7	
670.347	300 x 200	40 x 8	
DIN 875/1:			
670.322	75 x 50	15 x 5	
670.323	100 x 70	20 x 5	
670.324	150 x 100	25 x 5	
670.325	200 x 130	30 x 6	
670.326	250 x 165	35 x 7	
670.327	300 x 200	40 x 8	
670.328	400 x 265	45 x 10	
670.329	500 x 330	50 x 10	
670.330 ¹	600 x 400	50 x 10	
DIN 875/0, hardened (with inspection report):			
670.851	50 x 40	12 x 5	
670.852	75 x 50	15 x 5	
670.853	100 x 70	20 x 5	
670.854	150 x 100	25 x 5	
670.855	200 x 130	30 x 6	
670.762	250 x 165	35 x 7	
670.763	300 x 200	40 x 8	
670.764	400 x 265	45 x 10	
670.765	500 x 330	50 x 10	

¹ Incl. transport package.

- Hardened stainless steel.
- Lapped measuring faces.
- Accuracy according DIN 875.



670.323

All squares can be delivered with an inspection report or a certificate of a recognized measuring laboratory.

For the larger squares it is important to realize that external factors affect the stability of squares, which may influence the accuracy unfavourably.

Wooden cases for squares

Wooden cases for squares with base.



670.884

TECHNOBEARING

Item No.	Dimensions square/mm	Price RUB
670.463	50 x 40	
670.464	50 x 40 / 75 x 50	
670.465	100 x 70	
670.884	150 x 100	
670.885	200 x 130	
670.887	250 x 165	
670.887	300 x 200	
670.888	400 x 265	
670.889	500 x 330	

Stainless steel squares with base

- Hardened stainless steel.
- Lapped measuring faces.
- Accuracy according DIN 875.

Item No.	Dimensions mm	Cross-section/mm	Price RUB
DIN 875/1:			
907.287	75 x 50	15 x 5	
907.288	100 x 70	20 x 5	
907.289	150 x 100	25 x 5	
907.290	200 x 130	30 x 6	
907.291	250 x 160	35 x 7	
907.292	300 x 200	40 x 8	
DIN 875/0:			
907.272	50 x 40	12 x 5	
907.273	75 x 50	15 x 5	
907.274	100 x 70	20 x 5	
907.275	150 x 100	25 x 5	
907.276	200 x 130	30 x 6	



907.274

PRICE

Steel squares with base

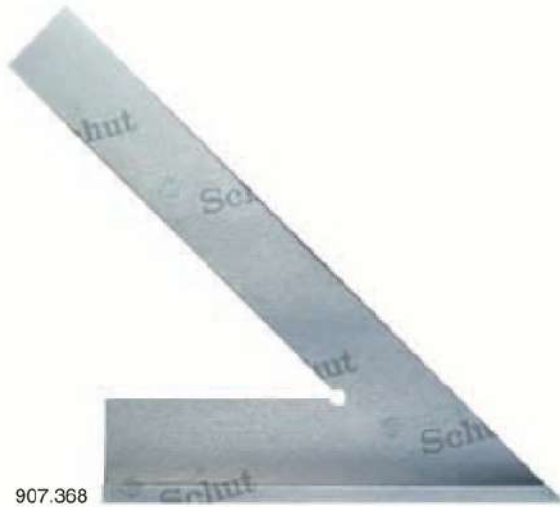

907.368



907.429

TECHNOBEARING

PRICE

Item No.	Dimensions mm	Cross-section/mm	Price RUB
Acute angle squares 45°, DIN 875/2:			
907.365	100 x 70	20 x 5	
907.366	120 x 80	20 x 5	
907.367	150 x 100	20 x 5	
907.368	200 x 130	25 x 5	
Acute angle squares 60°, DIN 875/2:			
907.389	100 x 70	20 x 5	
907.390	120 x 80	20 x 5	
907.391	150 x 100	20 x 5	
907.392	200 x 130	25 x 5	
Mitre squares 135°, DIN 875/2:			
907.427	100 x 70	20 x 5	
907.428	120 x 80	20 x 5	
907.429	150 x 100	20 x 5	
907.430	200 x 130	25 x 5	

007_307 Technobearing 201 (16x25)

Hardened stainless steel squares with heavy beam

TECHNOBEARING

Item No.	Dimensions mm	Cross-section/mm	Price RUB
With knife-edges (DIN 875/00):			
670.601	50 x 40	14 x 10/16 x 2	
670.602	75 x 50	14 x 10/18 x 2	
670.603	100 x 70	16 x 10/18 x 2	
670.604	150 x 100	20 x 12/22 x 2	
670.605	200 x 130	24 x 14/26 x 3	



670.604

Flange squares (not standardized)

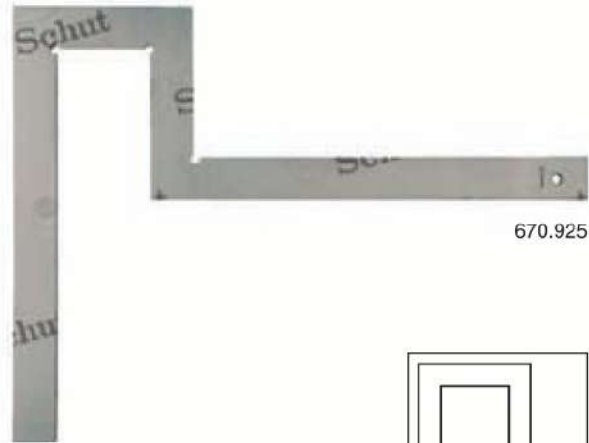
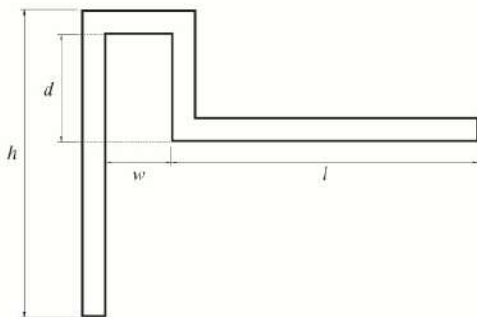

670.925

Item No.	Dimensions/mm				Price RUB
	l	h	w	d	
670.925	300	300	64	105	
670.926	400	400	65	115	
670.927	500	500	70	125	
670.928	600	600	71	124	

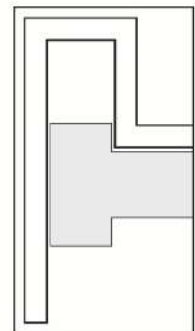

007.214. Technobearing 201 (9623)

Adjustable squares

Precise base with sliding straight edge. The straight edge can be moved continuously along the base and can be firmly clamped by the spindle. All measuring faces are ground and the complete square is hardened. The adjustable straight edge enables working with for instance short edges and grooves.



Item No.	Dimensions straight edge/mm	Dimensions base/mm	Price RUB
907.874	60 x 4 x 4	23 x 40 x 10	
909.407	125 x 8 x 8	30 x 75 x 12	



907.874

Squares with heavy beam

- Hardened stainless steel.
- Lapped measuring faces.
- Accuracy according DIN 875/0.



Item No.	Dimensions mm	Cross- section/mm	Price RUB
907.262	50 x 40	14 x 10/16 x 2	
907.263	75 x 50	14 x 10/16 x 2	
907.264	100 x 70	18 x 12/20 x 3	
907.265	150 x 100	24 x 14/25 x 3	
907.266	200 x 130	28 x 16/30 x 4	

907.264



Squares with heavy beam and knife-edges

- Hardened stainless steel.
- Lapped measuring faces.
- Accuracy according DIN 875/00.



Item No.	Dimensions mm	Cross- section/mm	Price RUB
907.245	50 x 40	14 x 10/16 x 2	
907.246	75 x 50	14 x 10/16 x 2	
907.247	100 x 70	18 x 12/20 x 3	
907.248	150 x 100	24 x 14/25 x 3	
907.249	200 x 130	28 x 16/30 x 4	

907.247



Beveled edge squares

- Hardened stainless steel.
- Lapped measuring faces.
- Accuracy according DIN 875/00.

TECHNOBEARING



Item No.	Dimensions mm	Cross-section/mm	Price RUB
907.250	50 x 40	12 x 4	
907.251	75 x 50	16 x 4	
907.252	100 x 70	20 x 5	
907.253	150 x 100	25 x 6	
907.254	200 x 130	30 x 7	



907.252

Beveled edge squares

- Hardened steel.
- Ground and lapped measuring faces.
- Accuracy according DIN 875/00.

Item No.	Dimensions/mm	Price RUB
Bright steel:		
670.403	50 x 40	
670.404	75 x 50	
670.405	100 x 70	
670.406	150 x 100	
670.407	200 x 130	
Stainless steel:		
670.433	50 x 40	
670.434	75 x 50	
670.435	100 x 70	
670.436	150 x 100	
670.437	200 x 130	



670.435

007.215 Technobearing 201 (9623)

Toolmakers' squares

- Hardened stainless steel.
- Lapped measuring faces.
- Accuracy according DIN 875/00.



Item No.	Dimensions mm	Cross-section/mm	Price RUB
907.255	25 x 20	6 x 3.5 / 5 x 3.5	
907.256	40 x 28	8 x 3.5 / 5 x 3.5	



Toolmakers' squares

LMW flat beveled edge squares, with the knife-edge on the inside.

Item No.	Dimensions mm	Angle	Price RUB
852.220	25 x 20	90°	
852.222	40 x 28	90°	
852.223	40 x 28	89°30'	
852.224	40 x 28	90°30'	



Aluminum square with graduation

- Measuring range: 0-300 mm.
- Graduation: 1 mm.
- Anodized aluminum.
- With base for scribing lines in 90° and 45°.
- Cross-section base: 40 x 14 mm, Cross-section ruler: 50 x 5 mm.

NEW

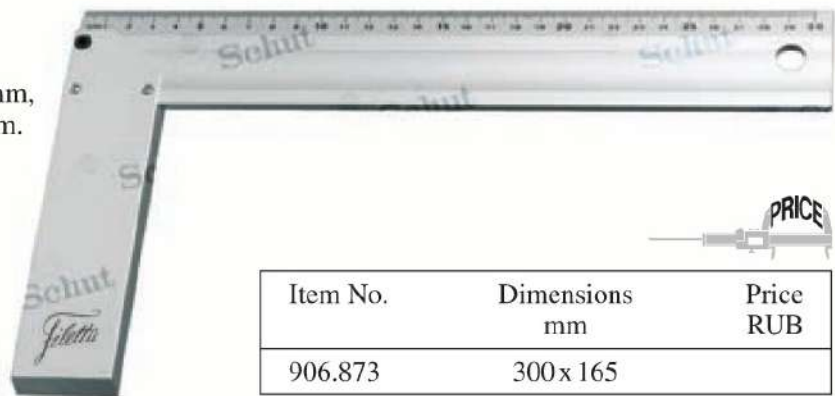

Item No.	Dimensions mm	Price RUB
906.873	300 x 165	

007_3D5 Technobearing 201 (9625)

Toolmakers' set

Consisting of:

- 1 beveled straight edge: 100 mm,
- 1 flat beveled edge square: 75 x 50 mm,
- 1 flat beveled edge square: 40 x 28 mm,
- 1 flat beveled edge square: 25 x 20 mm,
- 1 scriber: 8 x 8 x 60 mm.



TECHNOBEARING

Item No.	Description	Price RUB
852.201	Toolmakers' set	

Sine bar

By means of a sine bar and with gauge blocks, a reference plane can be created ($l = 150 \text{ mm}$, $w = 25 \text{ mm}$) at an angle of 0° to 60° with respect to the base. The base of the sine bar consists of two rollers with a center to center distance of $127 \pm 0.004 \text{ mm}$. In order to make a curve the gauge blocks are placed under one of the rollers.

- Straightness and parallelism: $5 \mu\text{m}$.

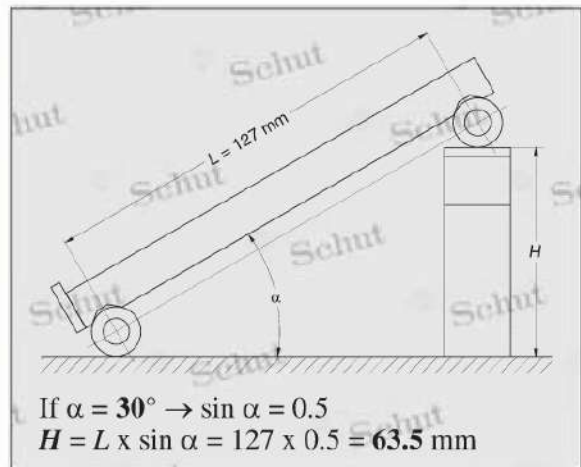

Item No.	Description	Price RUB
909.417	Sine bar	

Steel parallel blocks

Parallels to position and layout workpieces in e.g. clamping jaws for drilling, grinding, milling and measuring. The workpieces and assemblies can easily be set up to the desired working height.

- Parallelism of the two measuring faces: ± 0.005 mm.
- Size deviation (height): ± 0.01 mm.
- Hardness: 55 HRC.
- Ground in matched pairs.
- Produced of a high-grade steel alloy.
- Delivery in a case with a manufacturer's certificate.



(Only available in sets.)

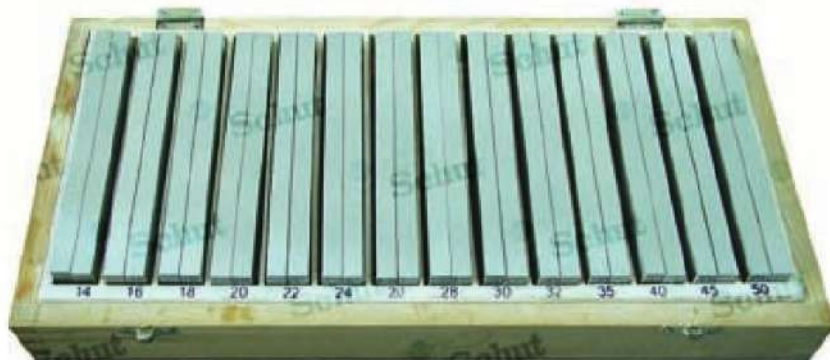

906.996



Item No.	Length mm	Price RUB	Width mm	Height mm
Set of 12 pairs:			10	14-16-18-20-22-24-26-28-30-32-35-40
909.800	100			
909.804	125			
906.995	150			
Set of 14 pairs:			10	14-16-18-20-22-24-26-28-30-32-35-40-45-50
909.802	100			
909.805	125			
906.996	150			
Set of 24 pairs:			8	11-16-21-26-31-36
909.803	100		10	13-18-23-28-33-38
909.806	125		12	15-20-25-30-35-40
906.997	150		14	17-22-27-32-37-42

TECHNOBEARING

009_3D3 Technobearing 201 (RUB25)

Granite parallels in pairs

Flatness, parallelism and straightness of measuring surfaces according DIN 874.

- Material: granite.
- Straight beveled edges.
- Delivery with an inspection report.



Item No.	Flatness/ Parallelism μm^1	Price RUB	Item No.	Flatness/ Parallelism μm^1	Price RUB	Dimensions mm	Weight per pair kg
Class 0, 2-sided:			Class 00, 2-sided:				
402.104	± 3		402.112	± 1.5		160 x 25 x 16	0.5
402.105	± 4		402.113	± 2		250 x 40 x 25	1.6
402.106	± 8		402.114	± 4		400 x 63 x 40	6.5
402.107	± 12		402.115	± 6		630 x 100 x 63	24.7
Class 0, 4-sided:			Class 00, 4-sided:				
402.100	± 3		402.108	± 1.5		160 x 25 x 16	0.5
402.101	± 4		402.109	± 2		250 x 40 x 25	1.6
402.102	± 8		402.110	± 4		400 x 63 x 40	6.5
402.103	± 12		402.111	± 6		630 x 100 x 63	24.7

¹ Flatness and parallelism between opposite surfaces.

Granite straight edges

Flatness, parallelism and straightness of measuring surfaces according DIN 874.

- From length 1000 mm equipped with two bores.
- Material: granite.
- Straight beveled edges.
- Delivery with an inspection report.



Item No.	Dimensions mm	Weight kg	Straightness/ Flatness/ μm	Parallelism μm	Price RUB
Class 0:					
402.135	400 x 60 x 25	2	± 2.6	± 13	
402.136	630 x 100 x 35	7	± 3.5	± 18	
402.137	1000 x 160 x 50	27	± 5	± 25	
402.138 ¹	1600 x 250 x 80	138	± 7.4	± 37	
402.139 ¹	2000 x 300 x 100	210	± 9	± 45	
Class 00:					
402.140	400 x 60 x 25	2	± 1.6	± 8	
402.141	630 x 100 x 35	7	± 2.1	± 10.5	
402.142	1000 x 160 x 50	27	± 3	± 15	
402.143 ¹	1600 x 250 x 80	138	± 4.4	± 22	
402.144 ¹	2000 x 300 x 100	210	± 5.4	± 27	

TECHNOBEARING

¹ Weight included package.

Bright steel and stainless steel straight edges DIN 874/1 and 874/0

- Length: 500 - 6000 mm.
- Rectangular cross-section up to length 1500 mm, from length 2000 mm I-shaped with two grip slots.
- Flatness of the measuring faces according DIN 874.
- Straight edges of length 1000 mm and longer are marked on the side face at the Bessel points.

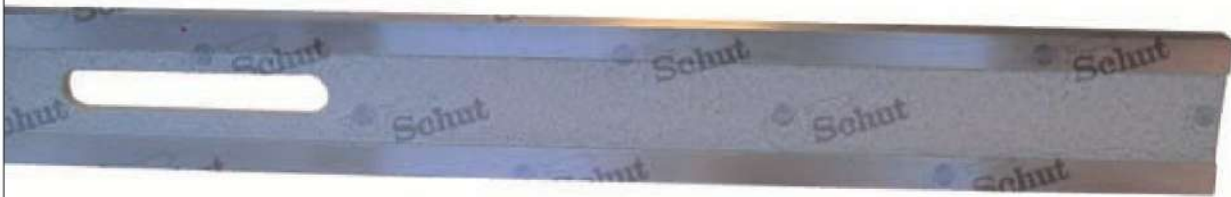

Bright steel

Item No.	Dimensions/mm	Price RUB
DIN 874/1:		
776.131	500 x 40 x 8	
776.140	750 x 50 x 10	
776.132	1000 x 50 x 10	
776.133	1500 x 60 x 12	
776.134	2000 x 70 x 15	
776.135	2500 x 80 x 15	
776.136	3000 x 100 x 16	
776.137	4000 x 120 x 20	
776.138	5000 x 140 x 20	
776.139	6000 x 140 x 20	
DIN 874/0:		
776.121	500 x 50 x 10	
776.120	750 x 50 x 10	
776.122	1000 x 60 x 12	
776.123	1500 x 70 x 15	
776.124	2000 x 80 x 15	
776.125	2500 x 100 x 16	
776.126	3000 x 120 x 20	
776.127	4000 x 140 x 20	
776.128	5000 x 140 x 20	
776.129	6000 x 140 x 20	

Stainless steel

Item No.	Dimensions/mm	Price RUB
DIN 874/1:		
776.231	500 x 40 x 8	
776.374	750 x 50 x 10	
776.232	1000 x 50 x 10	
776.233	1500 x 60 x 12	
776.234	2000 x 70 x 15	
776.235	2500 x 80 x 15	
DIN 874/0:		
776.221	500 x 50 x 10	
776.130	750 x 50 x 10	
776.222	1000 x 60 x 12	
776.223	1500 x 70 x 15	
776.224	2000 x 80 x 15	

TECHNOBEARING

Bright steel and stainless steel straight edges DIN 874/2

- Length: 500 - 6000 mm.
- Rectangular cross-section up to length 3000 mm, from length 4000 mm I-shaped with two grip slots.
- Flatness according DIN 874/2.

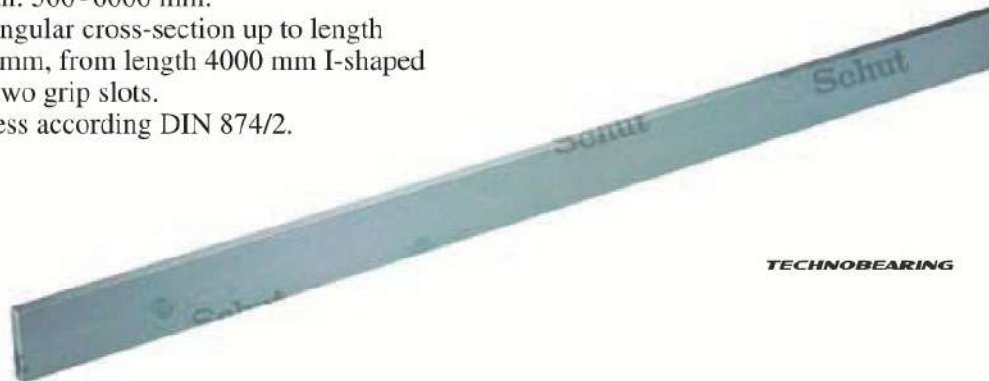

Bright steel

Item No.	Dimensions/mm	Price RUB
776.141	500 x 30 x 6	
776.142	750 x 40 x 8	
776.143	1000 x 40 x 8	
776.144	1500 x 50 x 10	
776.145	2000 x 60 x 12	
776.146	2500 x 70 x 15	
776.147	3000 x 80 x 15	
776.148	4000 x 100 x 16	
776.149	5000 x 120 x 20	
776.150	6000 x 120 x 20	

Stainless steel

Item No.	Dimensions/mm	Price RUB
776.388	500 x 30 x 6	
776.389	750 x 40 x 8	
776.380	1000 x 40 x 8	
776.381	1500 x 50 x 10	
776.382	2000 x 60 x 12	
776.383	2500 x 70 x 15	
776.384	3000 x 80 x 15	
776.385	4000 x 100 x 16	

Bright steel and stainless steel straight edges class 3

Class 3 straight edges are not standardized, i.e. there is no standard in which the accuracy classes are laid down. The accuracy is approximately maximum the double of the permissible error conform DIN 874/2.

Bright steel

Item No.	Dimensions/mm	Price RUB
776.151	500 x 30 x 6	
776.152	750 x 30 x 6	
776.153	1000 x 30 x 6	
776.154	1500 x 40 x 8	
776.155	2000 x 40 x 8	
776.156	2500 x 40 x 8	
776.157	3000 x 50 x 10	
776.158	4000 x 60 x 12	
776.159	5000 x 70 x 15	
776.160	6000 x 80 x 15	

Stainless steel

Item No.	Dimensions/mm	Price RUB
776.161	500 x 30 x 6	
776.162	750 x 30 x 6	
776.163	1000 x 30 x 6	
776.164	1500 x 40 x 8	
776.165	2000 x 40 x 8	
776.166	2500 x 40 x 8	
776.167	3000 x 50 x 10	
776.168	4000 x 60 x 12	
776.169	5000 x 70 x 15	
776.170	6000 x 80 x 15	

Aluminum straight edges

Light and therefore easy-to-use straight edges. Especially when using longer straight edges this is undoubtedly of great significance.

- Highly wear resistant.
- Highly corrosion resistant.
- Surface hardness: 500-550 HV.
- Highly insulating.
- With protective coating, thickness: 50 µm.
- With grip slots:
class 2: from length 2500 mm,
class 1 and 0: from length 1500 mm.
- Accuracy according DIN 874.



Item No.	Dimensions mm	Weight kg	Price RUB
DIN 874/2:			
776.191*	500 x 60 x 12	0.7	
776.192*	1000 x 60 x 12	1.4	
776.193*	1500 x 60 x 12	2.1	
776.194*	2000 x 60 x 12	2.8	
776.195	2500 x 100 x 16	7.2	
776.196	3000 x 100 x 16	8.7	
776.197	4000 x 100 x 16	11.6	
776.198	5000 x 150 x 20	26.7	
776.199	6000 x 150 x 20	32.1	

Item No.	Dimensions mm	Weight kg	Price RUB
DIN 874/1:			
776.181*	500 x 60 x 12	0.7	
776.182*	1000 x 60 x 12	1.4	
776.183	1500 x 100 x 12	4.3	
776.184	2000 x 100 x 12	5.8	
776.185	2500 x 100 x 12	7.2	
776.186	3000 x 150 x 20	15.9	
776.187	4000 x 150 x 20	21.3	
776.188	5000 x 150 x 20	26.7	
776.189	6000 x 150 x 20	32.1	

DIN 874/0:			
776.171*	500 x 60 x 12	0.7	
776.172*	1000 x 60 x 12	1.4	
776.173	1500 x 100 x 16	4.3	
776.174	2000 x 100 x 16	5.8	
776.175	2500 x 100 x 16	7.2	
776.176	3000 x 150 x 20	15.9	
776.177	4000 x 150 x 20	21.3	
776.178	5000 x 150 x 20	26.7	
776.179	6000 x 150 x 20	32.1	

TECHNOBEARING

* Without grip slots.

Steel straight edges for mounting

I-shaped construction with wide and extra wide measuring faces for application of spirit levels.

- Length: 500 - 6000 mm.
- Flatness of the measuring faces according DIN 874.
- Larger sizes available on request.



DIN 874/1

Item No.	Dimensions/mm	Price RUB
406.610	1000 x 100 x 30	
406.615	1500 x 100 x 30	
406.620	2000 x 120 x 40	
406.625	2500 x 120 x 40	
406.630	3000 x 140 x 40	
406.640	4000 x 140 x 40	
406.622	5000 x 160 x 40	
406.641	6000 x 160 x 40	

With extra wide measuring faces:

406.636	500 x 80 x 40
406.637	750 x 80 x 40
406.614	1000 x 160 x 50
406.638	1500 x 160 x 50
406.643	2000 x 160 x 50
406.644	2500 x 160 x 50
406.631	3000 x 180 x 60
406.645	4000 x 180 x 60
406.646	5000 x 200 x 80
406.647	6000 x 200 x 80

DIN 874/0

Item No.	Dimensions/mm	Price RUB
406.613	1000 x 100 x 30	
406.617	1500 x 100 x 30	
406.621	2000 x 120 x 40	
406.626	2500 x 120 x 40	
406.632	3000 x 140 x 40	
406.639	4000 x 140 x 40	
406.618	5000 x 160 x 40	
406.619	6000 x 160 x 40	

With extra wide measuring faces:

406.624	500 x 80 x 40
406.627	750 x 80 x 40
406.611	1000 x 160 x 50
406.616	1500 x 160 x 50
406.623	2000 x 160 x 50
406.628	2500 x 160 x 50
406.629	3000 x 180 x 60
406.633	4000 x 180 x 60
406.634	5000 x 200 x 80
406.635	6000 x 200 x 80

Cast iron straight edges with handles

Especially suitable for measuring small surfaces.

- Tension free.
- Flatness and parallelism according DIN 876.
- DIN 876/1: hand scraped,
DIN 876/0: fine scraped.
- Both measuring faces are flat and parallel
matched in pairs.



Dimensions l x w/mm	Weight approx./kg	DIN 876/1		DIN 876/0	
		Item No.	Price RUB	Item No.	Price RUB
500x35	12	403.705		403.700	
750x50	17	403.706		403.701	
1000x56	25	403.707		403.702	
1500x70	65	403.708		403.703	
2000x80	90	403.709		403.704	

Aluminum straight edges

I-shaped straight edges with wide measuring faces. Lightweight construction and material especially promote handling of longer straight edges.

- Highly wear resistant.
- Highly corrosion resistant.
- Surface hardness: 500-550 HV.
- High insulation: $4 \cdot 10^{15} \Omega \text{ mm}^2/\text{m}$.
- With protective coating, thickness: 50 μm .
- Accuracy according DIN 874/1.
- Larger sizes and class 0 available on request.



TECHNOBEARING

Item No.	Dimensions mm	Weight kg	Tolerance μm	Price RUB
406.650	500 x 100 x 40	1.65	12	
406.651	1000 x 100 x 40	3.31	21	
406.652	1500 x 100 x 40	4.97	29	
406.653	2000 x 100 x 40	6.62	37	
406.654	2500 x 100 x 40	8.28	46	
406.655	3000 x 100 x 40	9.93	54	

Bridge-type straight edges

Made of special close-grained cast iron.

- Tension relieved.
- Flatness according DIN 876:
class 1: hand scraped,
class 0: fine scraped.



Item No.	l x w mm	Weight kg	Flatness µm	Price RUB
DIN 876/1:				
403.658	500 x 40	6	15	
403.659	750 x 45	9	18	
403.680	1000 x 50	17	20	
403.690	1500 x 60	45	25	
403.692	2000 x 70	65	30	
403.698	3000 x 90	210	40	
DIN 876/0:				
403.657	500 x 40	6	6	
403.660	750 x 45	9	7	
403.679	1000 x 50	17	8	
403.691	1500 x 60	45	10	
403.696	2000 x 70	65	12	
403.697	3000 x 90	210	16	

Triangular straight edges

On two sides scraped, triangular straight edge with screwed-in handles. The edge between the scraped sides (45° or 60°) has been accurately processed. The third side has been ground, and recessed for weight reduction at the larger types (from 500 mm).

- Tension relieved.
- Flatness of both scraped sides according DIN 876:
class 1: hand scraped,
class 0: fine scraped.



TECHNOBEARING

Item No.	l x w/mm	Weight/kg	Price RUB
Triangular straight edge 45°, DIN 876/1:			
403.525	250 x 50	2	
403.550	500 x 75	7	
403.575	750 x 90	15	
403.600	1000 x 120	27	
403.602	1500 x 120	48	
Triangular straight edge 45°, DIN 876/0:			
403.524	250 x 50	2	
403.549	500 x 75	7	
403.574	750 x 90	15	
403.599	1000 x 120	27	
403.601	1500 x 120	48	
Triangular straight edge 60°, DIN 876/1:			
403.425	250 x 45	3	
403.450	500 x 60	6	
403.475	750 x 90	16	
403.500	1000 x 100	28	
403.502	1500 x 110	50	
Triangular straight edge 60°, DIN 876/0:			
403.424	250 x 45	3	
403.449	500 x 60	6	
403.474	750 x 80	16	
403.499	1000 x 100	28	
403.501	1500 x 110	50	

Beveled straight edges

- Straightness tolerance according DIN 874/00.
- Hardened and ground.
- Lapped measuring faces.
- With insulated grip over the entire length.



Item No.	Length/mm	Price RUB
Bright steel:		
772.075	75	
772.100	100	
772.125	125	
772.150	150	
772.200	200	
772.300	300	
772.400	400	
772.500	500	

Item No.	Length/mm	Price RUB
Stainless steel:		
772.076	75	
772.101	100	
772.126	125	
772.151	150	
772.201	200	
772.301	300	
772.401	400	
772.501	500	

Beveled straight edges

- Straightness tolerance according DIN 874/00.
- Hardened and ground.
- Lapped measuring faces.
- With insulated grip over the entire length.



Item No.	Length/mm	Price RUB
Chrome finished steel:		
907.750	75	
907.751	100	
907.752	125	
907.753	150	
907.754	200	
907.755	300	
907.756	400	
907.765	500	
909.237	600	

Item No.	Length/mm	Price RUB
Stainless steel:		
907.757	75	
907.758	100	
907.759	125	
907.760	150	
907.761	200	
907.762	300	
907.763	400	
907.764	500	
909.240	600	

Protractors / Clinometers / Spirit levels



Accuracy of clinometers/spirit levels according DIN 877		
Graduation µm/m	"	Flatness (µm) (L = length in mm)
≤ 50	≤ 10	4 + L/250
> 50 - 200	> 10 - 40	8 + L/125
> 200	> 40	16 + L/ 60

D00.D01. Technobearing 201 (RECS)

Universal digital bevel protractor

This digital bevel protractor displays both decimal degrees and degrees-minutes-seconds at the same time.

- Measuring range (switchable): 1x 360°,
2x 180°,
4x 90°.
- Resolution: 0.008° and 30".
- Accuracy: ±0.08° or ±5'.
- On/off switch.
- Reset/preset.
- Reversible measuring direction.
- Fine adjustment.
- Delivery in a case with three blades (150, 200 and 300 mm), a square and an acute angle attachment.
- Power supply: 1 battery type CR2032.



Item No.	Description	Price RUB
907.885	Bevel protractor	
Option:		
495.157	Spare battery	

Single blades

Item No.	Blade length/mm	Price RUB
909.380	150	
909.381	200	
909.382	300	
909.383	500	
909.384	600	
909.385	800	

Universal digital bevel protractors

Digital bevel protractors made of stainless steel, with blades of 150, 200, 300 or 500 mm. The blades and all the measuring faces are hardened.

- Measuring range (switchable): 1x 360°,
2x 180°,
4x 90°.
- Resolution: 1', or decimal 0.01°.
- Accuracy: ± 2'.
- Clamping spring system for blade.
- Indication switchable from degrees and minutes to decimal degrees.
- Automatic switch-off after 10 minutes of idle time with storage of the displayed measuring value.
- Opto-RS232C data output.
- Reset/preset/hold functions.
- Fine adjustment.
- Delivery in a case.
- Power supply: 1 battery type CR2032.

TECHNOBEARING



Complete bevel protractors

Item No.	Blade length/mm	Price RUB
856.688	150	
856.689	200	
856.690	300	
856.691	500	

Options:

- 495.157 Spare battery
- 856.694 Prism base
- 856.695 Ledge
- 781.887 Opto-RS232C cable

Single blades

Item No.	Blade length/mm	Price RUB
856.685	150	
856.693	200	
856.687	300	
856.686	500	



001.232 Technobearing 201 (9623)

Universal digital bevel protractor

This stainless steel, digital bevel protractor is available with blades from 150 to 1000 mm. The blades and all the measuring faces are hardened.

- Measuring range: $\pm 360^\circ$.
- Resolution: 1', or decimal 0.01°.
- Accuracy: $\pm 2'$.
- Repeatability: 1'.
- Indication switchable from degrees and minutes to decimal degrees.
- + and - direction reversible.
- Per 90° adjustable.
- Data output, Mitutoyo Digimatic compatible.
- On/off switch.
- Reset/preset/hold functions.
- Control with 5 keys for several functions.
- Fine adjustment.
- Delivery in a case without blade.
- Power supply: 1 battery type CR2032.



Single blades

Item No.	Description	Price RUB
855.820	Bevel protractor	
Options:		
495.157	Spare battery	
905.409	Data cable 2 m	

Item No.	Blade length/mm	Price RUB
909.380	150	
909.381	200	
909.382	300	
909.383	500	
909.384	600	
909.385	800	
855.827	1000	

Dial bevel protractor

- Measuring range: 4 x 90°.
- Graduation: 5'.
- Fine adjustment.
- Hardened stainless steel construction.
- Delivery in a case with 300 mm blade and an acute angle attachment.



TECHNOBEARING

Item No.	Description	Price RUB
906.504	Bevel protractor	

Single blades

Item No.	Blade length/mm	Price RUB
909.380	150	
909.381	200	
909.382	300	
909.383	500	
909.384	600	
909.385	800	

Bevel protractor with magnifier

- Measuring range: 4 x 90°.
- Vernier: 5', parallax-free.
- Hardened stainless steel construction.

- No-glare chrome finished scale.
- Delivery in a case with 300 mm blade and an acute angle attachment.



Item No.	Description	Price RUB
906.502	Bevel protractor with magnifier	
Option:		
906.505	Spare magnifier	

Single blades

Item No.	Blade length/mm	Price RUB
909.380	150	
909.381	200	
909.382	300	
909.383	500	
909.384	600	
909.385	800	

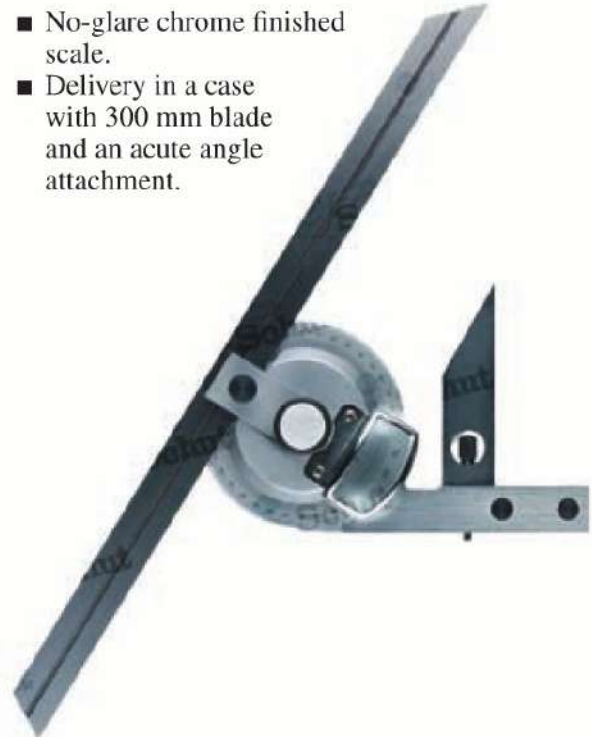

001.204 Technobearing 201 (9625)

Bevel protractor with magnifier

- Measuring range: 4 x 90°.
- Vernier: 5', parallax-free.
- Fine adjustment.
- Hardened stainless steel construction.
- No-glare chrome finished scale.

- Delivery in a case with two blades (150 and 300 mm) and an acute angle attachment.

Item No.	Description	Price RUB
855.801	Bevel protractor with magnifier	
Option:		
859.179	Spare magnifier	

Single blades

Item No.	Blade length/mm	Price RUB
909.380	150	
909.381	200	
909.382	300	
909.383	500	
909.384	600	
909.385	800	



Universal bevel protractor

Universal bevel protractor with micrometer screw adjustment. One rotation of the screw corresponds to an angular change of 1°. Retraction of the micrometer screw enables fast adjustment of the blade and the scale.

- Measuring range: 4 x 90°.
- Graduation: 1'.
- Stainless steel construction, main parts are hardened.
- Delivery in a case with two blades (150 and 300 mm) and a reference square for checking the bevel protractor.



Single blades

Item No.	Description	Price RUB
855.811	Universal protractor with magnifier	
Option:		
859.019	Spare magnifier	

Item No.	Blade length/mm	Price RUB
909.380	150	
909.381	200	
909.382	300	
909.383	500	
909.384	600	
909.385	800	

Combination bevel protractor

Can be used as bevel protractor, ruler, depth gauge, try square, center square and spirit level.

- Measuring range: 0-180° (90-0-90°).
- Graduation: 1°.
- Double graduation.
- Rotatable.
- Scriber (included in square head).
- Protractor head and square head provided with a spirit level.
- Ruler length: 300 mm.
- Delivery with protractor head, square head, center head, and ruler with mm/mm graduation.

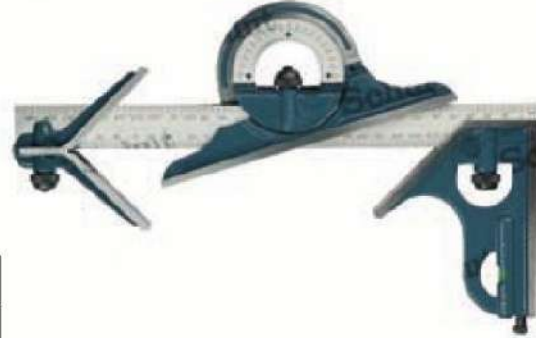

TECHNOBEARING

Item No.	Description	Price RUB
906.503	Combination bevel protractor	

Combination bevel protractor

Stainless steel combination bevel protractor with blade and flat square.

- Measuring range: 0-320°.
- Measuring inside and outside angles.
- Accurate adjustment by rack railway.
- Vernier: 2'.
- Delivery in a case.



Item No.	Description	Price RUB
910.215	Combination bevel protractor	

Bevel protractors

Simple and easy to use protractors with a semicircular or rectangular head and swivelling blade.

- Measuring range: 0-180°.
- Graduation: 1°.
- Scale diameter: 85 mm.
- Locking screw.
- Blade length: 150 mm.
- Hardened steel, no-glare chrome finished.



Item No.	Shape	Price RUB
907.863	semicircular	
909.399	rectangular	



Digital bevel protractors

- Measuring range: 0-180° (with swivelling blade) or 10-170° (with sliding blade).
- Graduation: 0.05°.
- Accuracy: 0.3°.
- On/off switch.
- Reset/hold function.
- Rotatable display value.
- Locking screw.
- Power supply: 1 battery (CR2032).

PRICE

Item No.	Scale ø/mm	Blade length/mm	Price RUB
With swivelling blade:			
906.457	120	150	
906.458	150	200	
906.459	200	300	
With sliding blade:			
906.767	100	150	
906.768	150	300	
906.769	200	400	
Option:			
495.157	Spare battery		



906.457

TECHNOBEARING

NEW



906.767

003.312. Technobearing 201 (9623)

Bevel protractors

- Measuring range: 0-180° (with swivelling blade) or 10-170° (with sliding blade).
- Graduation: 1°.
- Locking screw.
- Hardened steel, no-glare chrome finished.
- Graduation placed by laser.



Item No.	Scale ø/mm	Blade length/mm	Price RUB
With swivelling blade:			
907.864	80	120	
907.865	120	150	
907.866	150	200	
907.867	200	300	
907.868	300	500	
With sliding blade:			
907.869	100	150	
907.870	150	300	
907.871	200	400	
907.872	250	500	
907.873	300	600	

Setting bevel

- Special steel.
- Moveable blade locked with a wing nut.



Item No.	Blade length/mm	Price RUB
910.088	200	
910.089	300	
910.090	500	

Universal digital bevel protractor with spirit level

Digital bevel protractor for measuring both inside and outside angles. The measuring value is displayed upright at any time. Equipped with four holes and a locking knob for measuring a specific angle.

- Measuring range: 360°.
- Resolution: 0.05°.
- Accuracy: ±0.2°.
- ABS/INC switchable.
- With digital-analog display of the measured value.
- Reversal of display value.
- On/off switch.
- Hold function.
- Reversible measuring direction.
- Aluminum casing.
- Rotatable blade of metal.
- Dimensions: 254 x 50 x 36 mm.
- Power supply: 1 battery type CR2032.

Item No.	Description	Price RUB
909.503	Bevel protractor	
Option:		
495.157	Spare battery	



Universal digital bevel protractors

Digital bevel protractors for measuring both inside and outside angles. Equipped with a locking knob for measuring a specific angle.

- Measuring range: $\pm 360^\circ$.
- Resolution: 0.1° .
- Accuracy: $\pm 0.3^\circ$.
- On/off switch.
- Automatic switch-off.
- Zero setting at any position.
- Graduation rulers: 1 mm and 1/32 inch.
- Cross-section rulers: 35 x 2.5 mm.
- With fixing holes.
- Locking screw.
- Power supply: 1 battery type CR2032.



Item No.	Ruler length/mm	Price RUB
909.505	200	
909.506	300	
909.507	500	
Option:		
495.157	Spare battery	

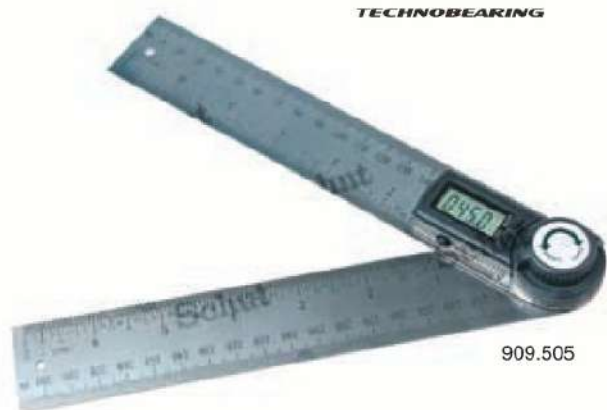

Magnetic clinometers with center point finder

Accurate clinometers with an extremely sensitive, balanced needle. The magnetic base with 90° V-groove is precision milled. The center point finder can be used as a center punch.

Very suitable for angular measurements, surface alignment, and the determination of center points and highest/lowest points of cylindrical and spherical surfaces. Therefore ideal as a universal aid to the installation of larger constructions.

- Measuring range: 360° .
- Graduation: 1° .
- Scale numbering: 0-360 clockwise (CW) or counterclockwise (CCW), or 0-90-0.
- Aperture V-groove (horizontal): 82 mm (for shafts up to $\phi 115$ mm).
- Dimensions $h \times w \times d$: 130 x 130 x 27 mm.

Item No.	Scale numbering	Price RUB
856.702	0-360 CCW	
856.703	0-360 CW	
856.704	0-90-0	
Options:		
856.705	Wooden case	
856.706	Suction magnifier glass	

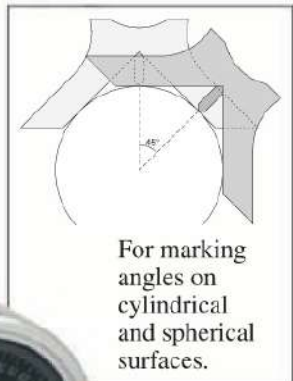

Digital clinometer

- Measuring range: 0-±180°.
- Resolution: 0.1°.
- Accuracy: ±0.2°.
- Rotatable display.
- Automatic switch-off.
- Hold function.
- Reference measurement function.

NEW

- With digital-analog read-out of the vial.
- With magnetic base with V-groove.
- Dimensions: 60x56x33 mm.
- Power supply: 2 batteries type AAA.

PRICE



Item No.	Description	Price RUB
906.427	Digital clinometer	
Option:		
497.914	Spare battery (2 needed)	

Digital clinometers

- Measuring range: ±180° (with external sensor: ±360°).
- Resolution: 0.1°.
- Accuracy 0- 10°: ±0.1°,
10- 170°: ±0.2°,
170- 180°: ±0.1°.
- Repeatability: 0.1°.

- ABS/INC switchable (except 906.476).
- Automatic switch-off.
- Hold function (only 906.479).
- With magnetic base (906.476/479) or magnetic upper part (909.501/502).
- Dimensions: 51 x 51 x 33 mm (906.476 and 909.501/502).
- Power supply: 1 battery type CR2032.

Models with external sensor

- Accuracy 0- 10°: ±0.1°,
10- 350°: ±0.2°,
350- 360°: ±0.1°.
- Sensor with mounting holes.
- Cable length: 1 m.
- Max. rotation speed: 600 rpm.



906.476



906.479



909.501



909.502

TECHNOBEARING

PRICE

Item No.	Description	Price RUB
906.476	Standard model	
906.479	With vial	
909.501	With external sensor	
909.502	With external sensor with axis ø 6 mm	
Option:		
495.157	Spare battery	

Digital clinometers

Instruments for easy measurement of angles, flatness and squareness. All four sides are measuring faces. The measuring value is displayed upright at any time.

- Measuring range: 4 x 90°.
- Resolution: 0.1° (909.504; 0.05°).
- Accuracy 0-10°: ±0.1°,
10-80°: ±0.2°,
80-90°: ±0.1°.
- Repeatability: 0.1°.
- ABS/INC switchable.
- Large, easy-to-read LCD display.
- Automatic switch-off.
- Hold function.
- Delivery in a case.

908.926

- Width measuring face: 6 mm.
- Measuring face bottom-side: 2 tapped holes M4, center distance 130 mm.
- Dimensions *l x w x h*: 151 x 33 x 53 mm.
- Power supply: 1 battery type CR2032.

909.504

- Blue backlight.
- Sound signal at stable value.
- °, mm/m, %, inch/ft conversion.
- Reference plane function.
- Measuring faces bottom- and upper-side with V-groove.
- With magnetic base (2 magnets).
- Protection: IP65.
- Dimensions *l x w x h*: 151 x 32 x 60 mm.
- Power supply: 2 batteries type AAA.



908.926



909.504



909.504

TECHNOBEARING



Item No.	Description	Price RUB
908.926	With tapped holes	
909.504	With V-grooves and magnetic base	
Options:		
495.157	Spare battery type CR2032	
497.914	Spare battery type AAA (2 needed)	

001.D08 Technobearing 201 (06/23)

Digital clinometers

Instruments for easy measurement of inclination. Equipped with a horizontal and vertical vial. The measuring value is displayed upright at any time.

- Measuring range: 4 x 90°.
- Resolution: 0.1°.
- Accuracy 0-10°: ±0.1°,
10-80°: ±0.2°,
80-90°: ±0.1°.
- °/‰ conversion.
- Large, easy-to-read LCD display.
- On/off switch.
- Hold function.
- Sound signal at: 0°, 45°, 90°.
- Laser spot (only 906.478).
- Measuring face on the bottom-side.
- Length: 600 mm.
- Delivery in a case.
- Power supply: 2 batteries type AAA.



Item No.	Description	Price RUB
906.477	Clinometer	
906.478	Clinometer with laser spot	
Option:		
497.914	Spare battery (2 needed)	

Laser alignment tool

With this alignment tool you can exactly, quickly and easily project vertical, horizontal and crossed laserlines. Within a range of ±4° minor inclination errors are automatically compensated by means of the integrated spirit level, to level the projected horizontal line.

- Range: up to 5 m (dependent on the lighting conditions).
- Self-levelling range: 4°.
- Horizontal and vertical accuracy: ±2 mm/m.
- Laser: 650 nm, class 2 conform to IEC 60825-1.
- Lock function for projecting at an angle and transport protection.
- Mounted on rotatable base.
- On/off switch.
- Diameter: ø 120 mm.
- Height: 170 mm.
- Weight: 420 g.
- Delivery in a case incl tripod.
- Power supply: 2 batteries type AA.



TECHNOBEARING



Item No.	Description	Price RUB
909.499	Alignment tool	
Option:		
495.111	Spare battery (2 needed)	

Inspection spirit levels

- Graduation main vial: 0.01 - 0.3 mm/m.
- With cross test vial.
- Base with V-groove.
- Base width: 42 mm
(spirit levels with length 500 mm: 44 mm).
- DIN 877.
- Delivery in a luxurious case.

Item No.	Length mm	Graduation mm/m	Price RUB
853.601	160	0.3	
853.606	160	0.1	
853.611	160	0.04	
853.616	160	0.02	
853.602	200	0.3	
853.607	200	0.1	
853.612	200	0.04	
853.617	200	0.02	
853.621	200	0.01	
853.603	250	0.3	
853.608	250	0.1	
853.613	250	0.04	
853.618	250	0.02	
853.622	250	0.01	
853.604	300	0.3	
853.609	300	0.1	
853.614	300	0.04	
853.619	300	0.02	
853.623	300	0.01	
853.605	500	0.3	
853.610	500	0.1	
853.615	500	0.04	
853.620	500	0.02	
853.624	500	0.01	

Inspection spirit levels

- Graduation main vial: 0.02 - 0.5 mm/m.
- Adjustable main vial.
- With cross test vial.
- Base with V-groove, interrupted at the center over 1/3 of the length.
- Base width: 40 mm.
- DIN 877.
- Delivery in a luxurious case.



Item No.	Length mm	Graduation mm/m	Price RUB
853.343	150	0.5	
853.341	150	0.1	
853.315	150	0.05	
853.348	150	0.02	
853.345	200	0.5	
853.344	200	0.1	
853.323	200	0.05	
853.322	200	0.02	
853.347	300	0.5	
853.346	300	0.1	
853.324	300	0.05	
853.325	300	0.02	



853.618

TECHNOBEARING

Inspection spirit levels

- Graduation main vial: 0.05 or 0.02 mm/m.
- Adjustable main vial.
- With cross test vial.
- Base with V-groove.
- Base width: 46 mm.
- Robust cast iron construction.
- With insulating grip.
- DIN 877.



908.685



Item No.	Length mm	Graduation mm/m	Price RUB
908.688	150	0.05	
908.684	150	0.02	
908.689	200	0.05	
908.685	200	0.02	
908.690	250	0.05	
908.686	250	0.02	
908.691	300	0.05	
908.687	300	0.02	

TECHNOBEARING

Frame spirit levels

- Graduation main vial: 0.05 or 0.02 mm/m.
- Adjustable main vial.
- With cross test vial.
- Two faces with V-groove, two flat faces.
- Robust cast iron construction.
- With insulating grip.
- DIN 877.



908.693



Item No.	Dimensions mm	Graduation mm/m	Price RUB
908.696	150 x 150 x 40	0.05	
908.692	150 x 150 x 40	0.02	
908.697	200 x 200 x 40	0.05	
908.693	200 x 200 x 40	0.02	
908.698	250 x 250 x 40	0.05	
908.694	250 x 250 x 40	0.02	
908.699	300 x 300 x 40	0.05	
908.695	300 x 300 x 40	0.02	

Frame spirit levels

- Graduation main vial: 0.01 - 0.3 mm/m.
- With cross test vial.
- Three faces with V-groove, one flat face.
- DIN 877.
- Delivery in a luxurious case.



853.638

Item No.	Dimensions mm	Graduation mm/m	Price RUB
853.625	100 x 100 x 34	0.3	
853.629	100 x 100 x 34	0.1	
853.633	100 x 100 x 34	0.04	
853.626	150 x 150 x 42	0.3	
853.630	150 x 150 x 42	0.1	
853.634	150 x 150 x 42	0.04	
853.637	150 x 150 x 42	0.02	
853.627	200 x 200 x 42	0.3	
853.631	200 x 200 x 42	0.1	
853.635	200 x 200 x 42	0.04	
853.638	200 x 200 x 42	0.02	
853.640	200 x 200 x 42	0.01	
853.628	300 x 300 x 44	0.3	
853.632	300 x 300 x 44	0.1	
853.636	300 x 300 x 44	0.04	
853.639	300 x 300 x 44	0.02	
853.641	300 x 300 x 44	0.01	

Frame spirit levels

- Graduation main vial: 0.02 - 0.5 mm/m.
- Adjustable main vial.
- With cross test vial.
- Three faces with V-groove, interrupted at the center over $\frac{1}{3}$ of the length. One flat face.
- DIN 877.
- Delivery in a luxurious case.

Item No.	Dimensions mm	Graduation mm/m	Price RUB
853.372	150 x 150 x 40	0.5	
853.371	150 x 150 x 40	0.1	
853.375	150 x 150 x 40	0.05	
853.376	150 x 150 x 40	0.02	
853.374	200 x 200 x 40	0.5	
853.373	200 x 200 x 40	0.1	
853.385	200 x 200 x 40	0.05	
853.382	200 x 200 x 40	0.02	
853.395	250 x 250 x 40	0.05	
853.392	250 x 250 x 40	0.02	



TECHNOBEARING

853.376

Crankshaft spirit levels

- Graduation main vial: 0.04 - 0.6 mm/m.
- With cross test vial.
- Base with a longitudinal and a lateral V-groove.

- Base width: 42 mm.
- DIN 877.



853.688

Item No.	Length mm	Graduation mm/m	Price RUB
853.684	60	0.6	
853.687	60	0.2	
853.682	90	0.3	
853.685	90	0.1	
853.688	90	0.04	
853.683	120	0.3	
853.686	120	0.1	
853.689	120	0.04	

Aluminum spirit levels

- Graduation vial: 0.6 mm/m.
- Base with V-groove.
- Base width: 22 mm.
- DIN 877.



853.677

TECHNOBEARING

Item No.	Length/mm	Price RUB
853.675	100	
853.676	150	
853.677	200	
853.678	250	
853.679	300	

Small spirit levels

Intended for simple tasks.

- Graduation vial: 0.1 or 0.3 mm/m.
- With longitudinal spirit level.
- Width: 24 mm.

- Equipped with mounting holes $\varnothing 5$ mm.
- Flat base.
- DIN 877.

Item No.	Length mm	Graduation mm/m	Price RUB
853.665	100	0.3	
853.666	100	0.1	
853.667	150	0.3	
853.668	150	0.1	



853.666

003.216 Technobearing 201 (9623)

Crankpin levels

Crankpin levels with two vials, in cast iron casing 80 x 80 mm, cross-section 20 x 20 mm, with two screw holes ϕ 4 mm.

TECHNOBEARING

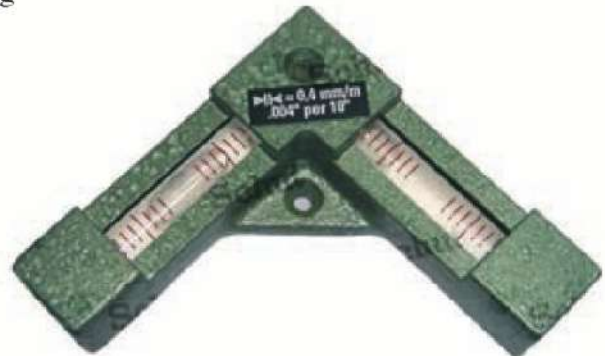

857.338

Item No.	Graduation mm/m	Price RUB
857.338	0.4	
857.339	0.1	
857.340	0.05	



857.342

Crankpin levels with two vials, in circular chrome casing with three screw holes ϕ 4 mm.

Item No.	Graduation mm/m	Dimensions mm	Screw holes ϕ /mm	Price RUB
857.342	0.4	ϕ 80 x 23	4	
857.343	0.1	ϕ 80 x 23	4	

Spirit levels with flat base

Spirit levels with a stainless steel strip base, no screw mounting, with an adjustable plexiglass vial mounted onto it, graduation approx. 5 mm/m.

Item No.	Dimensions base l x w x t/mm	Price RUB
857.344	100 x 20 x 5	
857.345	150 x 20 x 5	
857.346	200 x 20 x 5	



857.344

Spirit levels with a stainless steel strip base, no screw mounting, with two ground contact planes. Mounted onto this an adjustable spirit level with cast iron housing, graduation 1 mm/m.

Item No.	Dimensions base l x w x t/mm	Price RUB
857.347	100 x 20 x 5	
857.348	150 x 20 x 5	
857.349	200 x 20 x 5	



857.347

Circular spirit levels

Item No.	Diameter mm	Height mm	Sensitivity* mm/m	Price RUB
Plexiglass model with yellow and green base:				
857.315	12	7	approx. 22	
857.316	15	8	approx. 22	
857.317	18	9	approx. 22	
857.318	30	10	approx. 22	
Black synthetic model with frame and screw holes \varnothing 2.5 mm and yellow and green base:				
857.320	26/17	7 +3	approx. 19	
857.321	30/20	7.5+3.5	approx. 19	
Chrome casing and white base:				
857.323	15	10	approx. 8	
857.324	18	10	approx. 8	
Chrome casing with frame and screw holes \varnothing 2.5 mm (857.325: \varnothing 1.5 mm; 857.330/331: \varnothing 3.5 mm) and white base:				
857.325	20/13.5	7 +2	approx. 8	
857.326	25/17	7.5+2.5	approx. 8	
857.327	30/17	6.5+3.5	approx. 8	
857.328	35/20	7.5+3.5	approx. 6	
857.329	40/25	8 +4	approx. 6	
857.330	50/34	9.5+5.5	approx. 3	
857.331	60/39	10 +7	approx. 3	
857.332	25/17	7.5+2.5	approx. 2	
White, synthetic casing with frame and screw holes \varnothing 3 mm, additional scale circles and white base:				
857.336	60/45	4+6	Reading $0^{\circ} - 2^{\circ} - 5^{\circ}$	
Black, synthetic casing with frame and screw holes \varnothing 5 mm, additional scale circles and white base:				
857.337	100/75	5+10	Reading $0^{\circ} - 3^{\circ} - 6^{\circ}$	



*Sensitivity means: the angle at which the air bubble is moved to the next scale mark or edge of the vial.

Hose water level

- Measuring range: 10 cm.
- Graduation: 1 mm.
- Scale numbering: 5-0-5 cm.
- Hose length: 20 m (reducible).
- Hose cross-section: 7.5 mm.

Item No.	Description	Price RUB
906.819	Hose water level	



www.technobearing.ru

Gauge blocks / Measuring balls / Optical flats and parallel optical flats / Feeler gauges / Roughness specimens



011_001.
Technobearing 201 (96)23

Gauge blocks general

Which gauge block is the most suitable for you?

TECHNOBEARING

MATERIALS

Steel

Steel is the oldest material and remains the most commonly accepted for gauge blocks. If well taken care of, steel gauges guarantee many years of useful life. They must be cleaned carefully before and after use and stored in a protective case in a dry environment.

Tungsten carbide

When a higher degree of hardness is needed, tungsten carbide is the material to choose. It is less sensitive to wear and damage compared to hardened steel. Especially when used frequently, tungsten carbide has an increased life span compared to steel gauge blocks.

Ceramics

Ceramics is relatively wear resistant and has a high degree of strength and stability. It will not rust and is unaffected by chemicals.

Class 2

Class 2 gauge blocks are intended for general workshop use by skilled workers to set up, for example, measuring instruments.

Class 1

Class 1 gauge blocks are used as working standards in inspection rooms within the production to set and calibrate measuring instruments and equipment as well as to inspect tools, fixtures and machines.

Class 0

Class 0 gauge blocks, with their high accuracy, are intended for use by measuring technicians in environmentally controlled inspection rooms, for example to calibrate measuring equipments.

Class K

Class K gauge blocks have the highest class of accuracy. They are the length standards in a calibration laboratory and other calibration values are derived from these gauges. Only with a UKAS certificate – or with another certificate, accepted by UKAS as equivalent (e.g. DAkkS, RvA and COFRAC) – will these gauge blocks be at their best. The most accurate gauges can meet a tolerance of $\pm 0.05 \mu\text{m}$.

ACCURACY CLASSES

Gauge blocks are classified in upgrading order of accuracy according EN ISO 3650: 1998 in the classes: 2, 1, 0, K. The ISO 3650 is an international standard, which is adopted by national standards such as RvA, DAkkS, UKAS, BKO, SCS and COFRAC.

Accuracy according ISO 3650

Nominal size mm	Class K		Class 0		Class 1		Class 2	
	Tolerance on nominal size μm	Deviation* μm	Tolerance on nominal size μm	Deviation* μm	Tolerance on nominal size μm	Deviation* μm	Tolerance on nominal size μm	Deviation* μm
0.5 - 10	± 0.20	0.05	± 0.12	0.10	± 0.20	0.16	± 0.45	0.30
10 - 25	± 0.30	0.05	± 0.14	0.10	± 0.30	0.16	± 0.60	0.30
25 - 50	± 0.40	0.06	± 0.20	0.10	± 0.40	0.18	± 0.80	0.30
50 - 75	± 0.50	0.06	± 0.25	0.12	± 0.50	0.18	± 1.00	0.35
75 - 100	± 0.60	0.07	± 0.30	0.12	± 0.60	0.20	± 1.20	0.35
100 - 150	± 0.80	0.08	± 0.40	0.14	± 0.80	0.20	± 1.60	0.40
150 - 200	± 1.00	0.09	± 0.50	0.16	± 1.00	0.25	± 2.00	0.40
200 - 250	± 1.20	0.10	± 0.60	0.16	± 1.20	0.25	± 2.40	0.45
250 - 300	± 1.40	0.10	± 0.70	0.18	± 1.40	0.25	± 2.80	0.50
300 - 400	± 1.80	0.12	± 0.90	0.20	± 1.80	0.30	± 3.60	0.50
400 - 500	± 2.20	0.14	± 1.10	0.25	± 2.20	0.35	± 4.40	0.60
500 - 600	± 2.60	0.16	± 1.30	0.25	± 2.60	0.40	± 5.00	0.70
600 - 700	± 3.00	0.18	± 1.50	0.30	± 3.00	0.45	± 6.00	0.70
700 - 800	± 3.40	0.20	± 1.70	0.30	± 3.40	0.50	± 6.50	0.80
800 - 900	± 3.80	0.20	± 1.90	0.35	± 3.80	0.50	± 7.50	0.90
900 - 1000	± 4.20	0.25	± 2.00	0.40	± 4.20	0.60	± 8.00	1.00

* Deviation of the measuring face.

Steel gauge blocks

Steel gauge blocks with an excellent price-performance ratio.

- Hardness: 63 - 65 HRC.
- Expansion coefficient: $(11.5 \pm 1) \cdot 10^{-6}/^{\circ}\text{C}$.
- Cross-section: 0.5 - 10 mm: 30 x 9 mm,
> 10 mm: 35 x 9 mm.
- ISO 3650.
- Delivery with an inspection report.
- Sets delivered in case.

TECHNOBEARING



Steel gauge blocks in sets

Item No.	Class	Price RUB	Size mm	Increment mm	Pieces
M32:			1.005	—	1
906.622	2		1.01 - 1.09	0.01	9
906.621	1		1.1 - 1.9	0.1	9
906.620	0		1 - 9	1	9
			10 - 30	10	3
			50	—	1
M47:			1.005	—	1
906.625	2		1.01 - 1.09	0.01	9
906.624	1		1.1 - 1.9	0.1	9
906.623	0		1 - 24	1	24
			25 - 100	25	4
M87:			1.001 - 1.009	0.001	9
906.613	2		1.01 - 1.49	0.01	49
906.612	1		0.5 - 9.5	0.5	19
906.611	0		10 - 100	10	10
M88:			1.0005	—	1
906.628	2		1.001 - 1.009	0.001	9
906.627	1		1.01 - 1.49	0.01	49
906.626	0		0.5 - 9.5	0.5	19
			10 - 100	10	10
M112:			1.0005	—	1
906.631	2		1.001 - 1.009	0.001	9
906.630	1		1.01 - 1.49	0.01	49
906.629	0		0.5 - 24.5	0.5	49
			25 - 100	25	4

Steel gauge blocks, per piece

Size mm	Increment mm	ISO 3650/1 Price RUB	ISO 3650/0 Price RUB
0.5	—		
1	—		
1.0005	—		
1.001 - 1.009	0.001		
1.01 - 1.50	0.01		
1.6 - 2.0	0.1		
2.5 - 7.5	0.5		
8.0 - 10.0	0.5		
10.5 - 25.0	0.5		
30	—		
40	—		
50	—		
60	—		
70	—		
75	—		
80	—		
90	—		
100	—		

PRICE

Select steel gauge blocks

High quality steel gauge blocks, can be very well wringed to make a combination size. The steel gauge blocks are available in all accuracy classes of ISO 3650 (2, 1, 0, K). Only the most commonly used sizes can be found in this catalog. Special sizes and sets are available on request, as well as special sets for calibration of micrometers and calipers.

- Hardness: 800 HV.
- Expansion coefficient: $(11.5 \pm 1) \cdot 10^{-6} / ^\circ\text{C}$.
- Cross-section: 0.5 - 10 mm: 30 x 9 mm,
> 10 mm: 35 x 9 mm.
- ISO 3650.
- Delivery with a traceable inspection report.
- Delivery on request with a DAkkS certificate, UKAS acknowledged.
- Sets delivered in luxurious case.



TECHNOBEARING

Steel gauge blocks in sets

Item No.	Class	Price RUB	Size mm	Increment mm	Pieces
M32:					
831.915	1		1.005	-	1
831.914	0		1.01 - 1.09	0.01	9
			1.1 - 1.9	0.1	9
			1 - 9	1	9
			10 - 30	10	3
			60	-	1
M47:					
831.911	1		1.005	-	1
831.910	0		1.00 - 1.09	0.01	10
			1.1 - 1.9	0.1	9
			2 - 25	1	24
			50 - 100	25	3
M87:					
831.909	1		0.5	-	1
831.908	0		1.001 - 1.009	0.001	9
			1.00 - 1.50	0.01	51
			2.0 - 10.0	0.5	17
			20 - 100	10	9
M103:					
831.907	1		0.5	-	1
831.906	0		1.005	-	1
			1.00 - 1.50	0.01	51
			2.0 - 25.0	0.5	47
			50 - 100	25	3
M112:					
831.905	1		0.5	-	1
831.904	0		1.0005	-	1
			1.001 - 1.009	0.001	9
			1.00 - 1.50	0.01	51
			2.0 - 25.0	0.5	47
			50 - 100	25	3
M122:					
831.903	1		0.5	-	1
831.902	0		1.0005	-	1
			1.001 - 1.009	0.001	9
			1.00 - 1.50	0.01	51
			1.6 - 1.9	0.1	4
			2.0 - 25.0	0.5	47
			30 - 70	10	5
			75	-	1
			80 - 100	10	3

Steel gauge blocks, per piece

Size mm	Increment mm	ISO 3650/1 Price RUB	ISO 3650/0 Price RUB
0.5	-		
1	-		
1.0005	-		
1.001 - 1.009	0.001		
1.01 - 1.5	0.01		
1.6 - 1.9	0.1		
2.0 - 5.5	0.5		
6.0 - 10.0	0.5		
10.5 - 15.0	0.5		
15.5 - 20.0	0.5		
20.5 - 25.0	0.5		
30	-		
40	-		
50	-		
60	-		
70	-		
75	-		
80	-		
90	-		
100	-		

Tungsten carbide gauge blocks

Tungsten carbide gauge blocks with an excellent price-performance ratio and a low expansion coefficient. High resistance against corrosion.

- Hardness: 70-72 HRC.
- Expansion coefficient: $(8.5 \pm 1) \cdot 10^{-6}/^{\circ}\text{C}$.
- Cross-section: 0.5 - 10 mm: 30 x 9 mm,
> 10 mm: 35 x 9 mm.
- ISO 3650.
- Delivery with an inspection report.
- Sets delivered in case.

TECHNOBEARING



Tungsten carbide gauge blocks, per piece

Size mm	Increment mm	ISO 3650/1 Price RUB	ISO 3650/0 Price RUB
0.5	–		
1	–		
1.0005	–		
1.001-1.009	0.001		
1.01-1.50	0.01		
1.6-1.9	0.1		
2.0-10.0	0.5		
10.5-15.0	0.5		
15.5-25.0	0.5		
30	–		
40	–		
50	–		
60	–		
70	–		
75	–		
80	–		
90	–		
100	–		

Tungsten carbide gauge blocks in sets

Item No.	Class	Price RUB	Size mm	Increment mm	Pieces
M32:					
906.634	2		1.005	–	1
906.633	1		1.01-1.09	0.01	9
906.632	0		1.1-1.9	0.1	9
			1-9	1	9
			10-30	10	3
			50	–	1
M47:					
906.637	2		1.005	–	1
906.636	1		1.01-1.09	0.01	9
906.635	0		1.1-1.9	0.1	9
			1-24	1	24
			25-100	25	4
M87:					
906.662	2		1.001-1.009	0.001	9
906.661	1		1.01-1.49	0.01	49
906.660	0		0.5-9.5	0.5	19
			10-100	10	10
M112:					
906.643	2		1.0005	–	1
906.642	1		1.001-1.009	0.001	9
906.641	0		1.01-1.49	0.01	49
			0.5-24.5	0.5	49
			25-100	25	4

Select tungsten carbide gauge blocks

High quality tungsten carbide gauge blocks, can be very well wringed to make a combination size. The tungsten carbide gauge blocks are available in all accuracy classes of ISO 3650 (2, 1, 0, K). Only the most commonly used sizes can be found in this catalog. Special sizes and sets are available on request.

- Hardness: 1600 HV.
- Expansion coefficient: $(5.0 \pm 1) \cdot 10^{-6}/^{\circ}\text{C}$.
- Cross-section: 0.5 - 10 mm: 30 x 9 mm,
> 10 mm: 35 x 9 mm.
- ISO 3650.

- Delivery with a traceable inspection report.
- Delivery on request with a DAkkS certificate, UKAS acknowledged.
- Sets delivered in luxurious case.



TECHNOBEARING

SELECT

Tungsten carbide gauge blocks, per piece

Size mm	Increment mm	ISO 3650/1 Price RUB	ISO 3650/0 Price RUB
0.5	–		
1	–		
1.0005	–		
1.001 - 1.009	0.001		
1.01 - 1.50	0.01		
1.6 - 1.9	0.1		
2.0 - 5.5	0.5		
6.0 - 10.0	0.5		
10.5 - 15.0	0.5		
15.5 - 20.0	0.5		
20.5 - 25.0	0.5		
30	–		
40	–		
50	–		
60	–		
70	–		
75	–		
80	–		
90	–		
100	–		

Tungsten carbide gauge blocks in sets

Item No.	Class	Price RUB	Size mm	Increment mm	Pieces
M32:					
828.592	1		1.005	–	1
828.606	0		1.01 - 1.09	0.01	9
			1.1 - 1.9	0.1	9
			1 - 9	1	9
			10 - 30	10	3
			60	–	1
M46:					
828.590	1		1.001 - 1.009	0.001	9
828.604	0		1.00 - 1.09	0.01	10
			1.1 - 1.9	0.1	9
			2 - 10	1	9
			20 - 100	10	9
M47:					
828.589	1		1.005	–	1
828.603	0		1.00 - 1.09	0.01	10
			1.1 - 1.9	0.1	9
			2 - 25	1	24
			50 - 100	25	3
M87:					
828.587	1		0.5	–	1
828.601	0		1.001 - 1.009	0.001	9
			1.00 - 1.50	0.01	51
			2.0 - 10.0	0.5	17
			20 - 100	10	9
M103:					
828.585	1		0.5	–	1
828.599	0		1.005	–	1
			1.00 - 1.50	0.01	51
			2.0 - 25.0	0.5	47
			50 - 100	25	3
M112:					
828.584	1		0.5	–	1
828.598	0		1.0005	–	1
			1.001 - 1.009	0.001	9
			1.00 - 1.50	0.01	51
			2.0 - 25.0	0.5	47
			50 - 100	25	3
M122:					
828.583	1		0.5	–	1
828.597	0		1.0005	–	1
			1.001 - 1.009	0.001	9
			1.00 - 1.50	0.01	51
			1.6 - 1.9	0.1	4
			2.0 - 25.0	0.5	47
			30 - 70	10	5
			75	–	1
			80 - 100	10	3

Ceramic gauge blocks

Ceramic gauge blocks with an excellent price-performance ratio, made of Zirconia ceramics. Because of this, these gauge blocks are highly durable, corrosion proof and completely stable for long-term use.

- Highly wear-resistant. Can be used 5 to 10 times longer than steel gauge blocks.
- Rustproof.
- Hardness: 88-90 HRC.
- Expansion coefficient: $(9.2 \pm 1) \cdot 10^{-6}/^{\circ}\text{C}$.
- Cross-section: 0.5 - 10 mm: 30x9 mm,
> 10 mm: 35x9 mm.
- ISO 3650.
- Delivery with an inspection report.
- Sets delivered in case.



TECHNOBEARING

Ceramic gauge blocks, per piece

Size mm	Increment mm	ISO 3650/1 Price RUB	ISO 3650/0 Price RUB
0.5	–		
1	–		
1.0005	–		
1.001 - 1.009	0.001		
1.01 - 1.49	0.01		
1.5 - 1.9	0.1		
2.0 - 5.5	0.5		
6.0 - 9.5	0.5		
10.0 - 20.0	0.5		
20.5 - 25.0	0.5		
30	–		
40	–		
50	–		
60	–		
70	–		
75	–		
80	–		
90	–		
100	–		

Ceramic gauge blocks in sets

Item No.	Class	Price RUB	Size mm	Increment mm	Pieces
M32:			1.005	–	1
906.646	1		1.01 - 1.09	0.01	9
906.645	0		1.1 - 1.9	0.1	9
			1 - 9	1	9
			10 - 30	10	3
			50	–	1
M47:			1.005	–	1
906.649	1		1.01 - 1.09	0.01	9
906.648	0		1.1 - 1.9	0.1	9
			1 - 24	1	24
			25 - 100	25	4
M87:			1.001 - 1.009	0.001	9
906.652	1		1.01 - 1.49	0.01	49
906.651	0		0.5 - 9.5	0.5	19
			10 - 100	10	10
M103:			1.005	–	1
906.655	1		1.01 - 1.49	0.01	49
906.654	0		0.5 - 24.5	0.5	49
			25 - 100	25	4
M112:			1.0005	–	1
906.658	1		1.001 - 1.009	0.001	9
906.657	0		1.01 - 1.49	0.01	49
			0.5 - 24.5	0.5	49
			25 - 100	25	4

PRICE

Select ceramic gauge blocks

High quality ceramic gauge blocks, can be very well wringed to make a combination size. The ceramic gauge blocks are available in all accuracy classes of ISO 3650 (2, 1, 0, K). Only the most commonly used sizes can be found in this catalog. Special sizes and sets are available on request, as well as special sets for calibration of micrometers and calipers.

- Hardness: 1350 HV.
- Expansion coefficient: $(9.5 \pm 1) \cdot 10^{-6}/^{\circ}\text{C}$.

- Cross-section: 0.5 - 10 mm: 30x9 mm,
> 10 mm: 35x9 mm.
- ISO 3650.
- Delivery with a traceable inspection report.
- Delivery on request with a DAkkS certificate, UKAS acknowledged.
- Sets delivered in luxurious case.

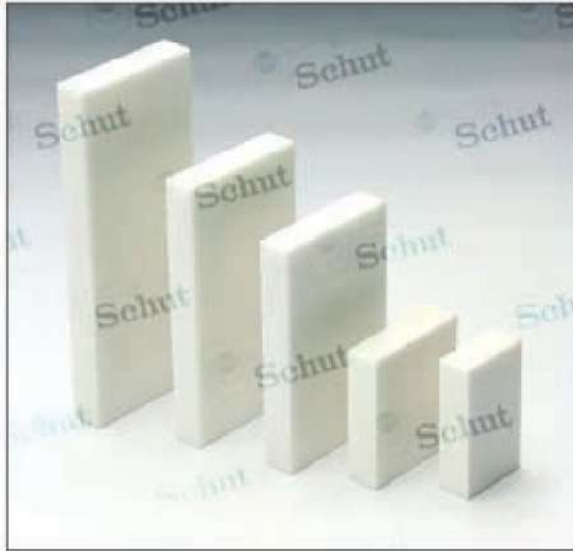

TECHNOBEARING

SELECT

Ceramic gauge blocks, per piece

Size mm	Increment mm	ISO 3650/1 Price RUB	ISO 3650/0 Price RUB
0.5	-		
1	-		
1.0005	-		
1.001 - 1.009	0.001		
1.01 - 1.50	0.01		
1.6 - 1.9	0.1		
2.0 - 5.5	0.5		
6.0 - 10.0	0.5		
10.5 - 15.0	0.5		
15.5 - 20.0	0.5		
20.5 - 25.0	0.5		
30	-		
40	-		
50	-		
60	-		
70	-		
75	-		
80	-		
90	-		
100	-		

Ceramic gauge blocks in sets

Item No.	Class	Price RUB	Size mm	Increment mm	Pieces
M32:					
831.085	1		1.005	-	1
831.084	0		1.01 - 1.09	0.01	9
			1.1 - 1.9	0.1	9
			1 - 9	1	9
			10 - 30	10	3
			60	-	1
M47:					
831.081	1		1.005	-	1
831.080	0		1.00 - 1.09	0.01	10
			1.1 - 1.9	0.1	9
			2 - 25	1	24
			50 - 100	25	3
M87:					
831.079	1		0.5	-	1
831.078	0		1.001 - 1.009	0.001	9
			1.00 - 1.50	0.01	51
			2.0 - 10.0	0.5	17
			20 - 100	10	9
M103:					
831.077	1		0.5	-	1
831.076	0		1.005	-	1
			1.00 - 1.50	0.01	51
			2.0 - 25.0	0.5	47
			50 - 100	25	3
M112:					
831.075	1		0.5	-	1
831.074	0		1.0005	-	1
			1.001 - 1.009	0.001	9
			1.00 - 1.50	0.01	51
			2.0 - 25.0	0.5	47
			50 - 100	25	3
M122:					
831.073	1		0.5	-	1
831.072	0		1.0005	-	1
			1.001 - 1.009	0.001	9
			1.00 - 1.50	0.01	51
			1.6 - 1.9	0.1	4
			2.0 - 25.0	0.5	47
			30 - 70	10	5
			75	-	1
			80 - 100	10	3

011.014. Technobearing 201 (REB25)

Long gauge blocks from 125 mm

Long steel gauge blocks with an excellent price-performance ratio. These steel gauge blocks are available in the accuracy classes 0, 1 and 2 of ISO 3650. All gauge blocks have two coupling holes on both ends so that they can be coupled by means of a toggle clamp.

- Hardness: 63-65 HRC.
- Expansion coefficient: $(11.5 \pm 1) \cdot 10^{-6} / ^\circ\text{C}$.
- Cross-section: 35 x 9 mm.
- ISO 3650.
- Delivery in a case with an inspection report.



TECHNOBEARING

PRICE

Size/mm	Item No.	Price RUB	Item No.	Price RUB	Item No.	Price RUB
	ISO 3650/2:		ISO 3650/1:		ISO 3650/0:	
125	907.728		907.715		907.702	
150	907.729		907.716		907.703	
175	907.730		907.717		907.704	
200	907.731		907.718		907.705	
250	907.732		907.719		907.706	
300	907.733		907.720		907.707	
400	907.734		907.721		907.708	
500	907.735		907.722		907.709	
600	907.736		907.723		907.710	
700	907.737		907.724		907.711	
800	907.738		907.725		907.712	
900	907.739		907.726		907.713	
1000	907.740		907.727		907.714	
Gauge block set consisting of 125, 150, 175, 200, 250, 300, 400 and 500 mm:						
	907.743		907.742		907.741	
Gauge block set consisting of 600, 700, 800, 900 and 1000 mm:						
	907.746		907.745		907.744	

Select long gauge blocks from 125 mm

High quality long steel gauge blocks. These steel gauge blocks are available in the accuracy classes 0, 1 and 2 of ISO 3650. All gauge blocks have two coupling holes on both ends so that they can be coupled by means of a toggle clamp.

- Hardness: 800 HV.
- Expansion coefficient: $(11.5 \pm 1) \cdot 10^{-6} / ^\circ\text{C}$.
- Cross-section: 35 x 9 mm.
- ISO 3650.
- Delivery in a luxurious case with a traceable inspection report.
- Delivery on request with a DAkkS certificate, UKAS acknowledged.
- Gauge blocks of 1000 - 1500 mm incl. a DAkkS certificate, UKAS acknowledged available on request.

NEW



831.937

TECHNOBEARING

SELECT!

Size/mm	Item No.	Price RUB	Item No.	Price RUB	Item No.	Price RUB
	ISO 3650/2:		ISO 3650/1:		ISO 3650/0:	
125	831.019		831.008		831.000	
150	831.020		831.009		831.001	
175	831.021		831.010		831.002	
200	831.022		831.011		831.003	
250	831.023		831.012		831.936	
300	831.024		831.013		831.937	
400	831.025		831.981		831.946	
500	831.026		831.738		831.004	
600	831.027		831.014		831.947	
700	831.028		831.015		831.005	
800	831.029		831.016		831.948	
900	831.030		831.017		831.006	
1000	831.031		831.018		831.007	
Gauge block set consisting of 125, 150, 175, 200, 250, 300, 400 and 500 mm:						
	831.088		831.087		831.086	
Gauge block set consisting of 600, 700, 800, 900 and 1000 mm:						
	831.091		831.090		831.089	

Toggle clamp for long series gauge blocks

Toggle clamp for the coupling of gauge blocks over 100 mm which have coupling holes on both ends. Very quick assembly by means of spring clamping device (with locking screw).

Item No.	Description	Price RUB
619.031	Toggle clamp for long series gauge blocks	



011.015 Technobearing 2019 (6/625)

Caliper inspection set

For checking the accuracy of DIN 862 calipers. The set consists of three special steel gauge blocks (30 mm, 41.3 mm and 131.4 mm, ISO 3650 class 1), two steel setting rings (ø4 mm and ø25 mm) and a pair of gloves.



TECHNOBEARING



Item No.	Description	Price RUB
909.347	Caliper inspection set	

Micrometer inspection sets

For the inspection of micrometers according DIN 863. Suitable for micrometers with a measuring range up to 25 mm.

- Nominal sizes (mm):
2.5 - 5.1 - 7.7 - 10.3 - 12.9 - 15.0 - 17.6 - 20.2 - 22.8 - 25.0.
- Including plan parallel optical flat ø30 x 12 mm.



Item No.	Material	Grade	Price RUB
909.346	steel	1	
909.345	steel	0	
909.162	ceramic	1	
909.340	ceramic	0	



Select microfibre cleaning cloth

Microfibre cleaning cloth for gauge blocks. Ideal for measuring rooms.

- Dimensions: 22.5 x 22.5 cm.



Item No.	Description	Price RUB
831.739	Microfibre cleaning cloth	

011_307 Technobearing 201 (9628)

Gauge block accessories

Various accessories to extract the resulting size of one or more gauge blocks outside or to convert it into an inside gauge. This also enables the creation of setting gauges and marking tools. These accessories considerably increase the applicability of standard gauge blocks.

TECHNOBEARING



907.202



907.204



907.210



907.209



907.207



907.213



907.211 907.212

Item No. Description	Price RUB	Set		
		M8	M10	M12
Holder for gauge blocks:				
907.203 Up to 50 mm		•	•	•
907.204 Up to 100 mm		•	•	•
907.205 Up to 200 mm		•	•	•
Pair of measuring jaws, with measuring faces:				
907.206 Cylindrical ϕ 2 mm and flat ($l=40$ mm)		•	•	•
907.207 Cylindrical ϕ 5 mm and flat ($l=45$ mm)		•	•	•
907.208 Cylindrical ϕ 10 mm and flat ($l=70$ mm)			•	•
907.209 Flat ($l=100$ mm, $h=19$ mm)			•	•
907.213 V-shaped ($l=60$ mm, max. ϕ 60 mm)			•	•
907.210 Straight edge ($l=100$ mm)				•
907.211 Scriber ($l=45$ mm)		•	•	•
907.212 Center point ($l=45$ mm)		•	•	•
907.214 Base for holder ($h=25$ mm)		•	•	•
Accessory sets, delivered in a case:		↑	↑	↑
907.200 M8				
907.201 M10				
907.202 M12				

011.275 Technobearing 201 (9623)

Holder for gauge blocks

Holder for gauge blocks for fixation of gauge blocks for serial inspection. Can also be used in combination with inspection sets for micro-meters and calipers.

- Suited for use with 10 gauge blocks.
- Anodized aluminum with steel base and hard plastic clamping blocks.
- Thickness gauge block: 9 mm conform ISO 3650.
- Delivery in a luxury plastic case incl. Allen key.

NEW



Item No.	Description	Price RUB
910.192	Holder for gauge blocks	

Holder for gauge blocks

- Anodized aluminum.
- Thickness gauge block: 9 mm conform ISO 3650.

NEW



Item No.	Description	Price RUB
906.434	Holder for gauge blocks	

Gloves

Comfortable, smooth, lint-free gloves with universal, perfect fit. Ideal for handling gauge blocks and other measuring instruments.

- Perfect thermal isolation.
- Washing machine safe.



Item No.	Description	Price RUB
191.069	Pair of gloves	

011.317. Technobearing 201 (06/23)

Angle gauge block set

Set of twelve hardened steel angle gauge blocks, comprising the angles 1/4° (15'), 1/2° (30'), 1°, 2°, 3°, 4°, 5°, 10°, 15°, 20°, 25° and 30°. A combination of angle gauge blocks is possible.

- Accuracy: ± 30".
- Thickness gauge blocks: 6 mm.
- Delivery in a case with a manufacturer's certificate.

TECHNOBEARING



Item No.	Description	Price RUB
909.799	Angle gauge block set	



Steel measuring balls

Set of steel measuring balls for measuring e.g. internal tapers. This set contains of a series of balls of different sizes, with two balls of each size.

- Material: chrome alloy steel.
- Hardness: 63 HRC.
- Nominal dimension tolerance: < 2.5 µm.
- Roundness: < 0.6 µm.
- Surface roughness: < 0.05 µm.
- Set 909.647: Delivery in a plastic case.
- Delivery with a manufacturer's certificate.

Item No.	Size mm	Pieces	Price RUB
910.224	1	2	
910.225	2	2	
910.226	3	2	
910.227	4	2	
910.228	5	2	
910.229	6	2	
910.230	7	2	
910.231	8	2	
910.232	9	2	
910.233	10	2	
910.234	11	2	
910.235	12	2	
910.237	13	2	
910.238	14	2	
910.239	15	2	
910.240	16	2	
910.241	17	2	
910.242	18	2	
910.243	19	2	
910.244	20	2	
910.245	21	2	
910.246	22	2	
910.247	23	2	
910.248	24	2	
910.249	25	2	



Set

Item No.	Size mm	Incr. mm	Number per size	Total number	Price RUB
909.647	1 - 25	1	2	50	



Select optical flats

Optical flats can be used for inspection of the flatness of reflecting surfaces of for example gauge blocks, settings gauges and other lapped surfaces by optical interference.

- Flatness measuring faces: $\leq 0.10 \mu\text{m}$.
- Wedge angle error: $> 10.0'$ (optical flats, double sided).
- On request with a DAkkS certificate, UKAS acknowledged.
- Delivery in a case.

Item No.	Diameter mm	Thickness mm	Price RUB
Single optical flats, single sided:			
826.625	30	15	
826.626	45	15	
826.627	50	20	
826.628	60	20	
826.629	75	20	
Single optical flats, double sided:			
827.011	30	15	
826.631	45	15	
826.632	50	20	
826.633	60	20	
826.634	75	20	



NEW

TECHNOBEARING



Select plan parallel optical flats

Plan parallel optical flats can be used for inspection of the parallelism and flatness of measuring surfaces of micrometers and other measuring instruments. Each set consists of 4 sizes plan parallel optical flats for inspection of micrometers on every fourth rotation of the spindle.

- For micrometers with a spindle pitch of 0.5 mm.
- Sets for micrometers with a measuring range of 0-25 mm, 25-50 mm, 50-75 mm and 75-100 mm.
- Flatness measuring faces: $\leq 0.15 \mu\text{m}$.
- Parallelism measuring faces: $\leq 0.3 \mu\text{m}$.
- Diameter: 30 mm.
- On request with a DAkkS certificate, UKAS acknowledged (except 907.909 and 907.910).
- Delivery in a case.



826.635

Item No.	Thicknesses/mm	Price RUB
826.635	12.00/12.12/12.25/12.37	
826.636	25.00/25.12/25.25/25.37	
907.909	50.00/50.12/50.25/50.37	
907.910	75.00/75.12/75.25/75.37	
Option:		
826.630	Single plan parallel optical flat, thickness 12.00 mm	



NEW

Feeler gauges

Feeler gauge sets in a holder, for individual use or in combination to measure slits and gaps and also for checking the amount of clearance in sliding guides, bearings, pistons etc.

- Measuring range: 0.03 - 2.00 mm.
- Blade length: 100 mm.
- Nickel plated handle with locking screw.
- Blade width: 10 mm (except stainless steel models: 12 mm), tapered.
- Accuracy according DIN 2275 T2.
- Also available in brass model (anti-magnetic).



Item No.	Number of blades	Increment(s)				Material	Price RUB
		0.01 mm	0.02 mm	0.05 mm	0.10 mm		
909.904	8			0.05 → 0.30	0.40 → 0.50	hardened steel	
909.905	8			0.05 → 0.30	0.40 → 0.50	stainless steel	
909.906	8			0.05 → 0.30	0.40 → 0.50	brass	
909.907	13			0.05 → 0.30	0.40 → 1.00	hardened steel	
909.908	13			0.05 → 0.30	0.40 → 1.00	stainless steel	
909.909	13			0.05 → 0.30	0.40 → 1.00	brass	
910.019	20			0.05 → 1.00		hardened steel	
910.020	20			0.05 → 1.00		stainless steel	
910.021	20			0.05 → 1.00		brass	
910.022	8	0.03 → 0.10				hardened steel	
910.023	10	0.03 → 0.05		0.10 → 0.30	0.40 → 0.50	hardened steel	
910.024	10				0.10 → 1.00	hardened steel	
910.026	14	0.03 → 0.10		0.15 → 0.30	0.40 → 0.50	hardened steel	
910.027	18	0.05 → 0.10		0.15 → 0.40	0.50 → 1.00	hardened steel	
910.028	19	0.03 → 0.10		0.15 → 0.30	0.40 → 1.00	hardened steel	
910.029	20	0.04 → 0.10		0.15 → 0.50	0.60 → 1.00	hardened steel	
908.978	22	0.03 → 0.05		0.10 → 1.00		hardened steel	
908.979	28	0.03 → 0.10	0.12 → 0.50			hardened steel	
910.034	21			0.05 → 0.10	0.20 → 2.00	hardened steel	

Feeler gauges

- Measuring range: 0.05 - 1.00 mm;
20 blades: 0.05 / 0.10 → 1.00.
- Material: hardened steel.
- Blade width: 12.8 mm.



Item No.	Blade length/mm	Price RUB
910.030	200	
910.031	300	
910.033	500	



910.031

Feeler stock coils

Feeler stock coils made of steel.

- Measuring range: 0.005 - 1.00 mm. **TECHNOBEARING**
- Length: 5 m.
- Width: 13 mm.
- Other widths or material (stainless steel or brass) available on request.



856.045



856.030



856.032

Options

Item No.	Description	Price RUB
856.030	Set 0.01 - 0.25 mm	
856.031	Set 0.3 - 1.00 mm	
856.032	Holder for feeler stock coils	

Item No.	Thickness/mm	Price RUB
856.036	0.005	
856.037	0.01	
856.038	0.02	
856.039	0.03	
856.040	0.04	
856.041	0.05	
856.042	0.06	
856.043	0.07	
856.044	0.08	
856.045	0.09	
856.046	0.10	
856.047	0.12	
856.048	0.15	
856.049	0.18	
856.050	0.20	
856.051	0.25	
856.052	0.30	
856.053	0.35	
856.054	0.40	
856.055	0.45	
856.056	0.50	
856.057	0.55	
856.058	0.60	
856.059	0.65	
856.060	0.70	
856.061	0.75	
856.062	0.80	
856.063	0.85	
856.064	0.90	
856.065	0.95	
856.066	1.00	

Roughness specimens in a set



850.130

This set consists of 30 specimens, mounted in an attractive wallet with instruction card. In addition to the *Ra* values, the standardized *N* values and the *Rz* values are specified.

TECHNOBEARING

Set composition

Item No.	Language	Price RUB
850.130	English	
850.131	French	
850.132	German	

On request available with a declaration of conformity.

Number of specimens	Machining method	Roughness <i>Ra</i> /μm	Roughness class <i>N</i>
3	Flat lapping	0.05- 0.2	2, 3, 4
3	Reaming	0.4 - 1.6	5, 6, 7
6	Grinding	0.05- 1.6	2, 3, 4, 5, 6, 7
6	Horizontal milling	0.4 -12.5	5, 6, 7, 8, 9, 10
6	Vertical milling	0.4 -12.5	5, 6, 7, 8, 9, 10
6	Turning	0.4 -12.5	5, 6, 7, 8, 9, 10

Roughness specimens

Series of roughness specimens, type Microsurf, covering the nine most frequently occurring manufacturing operations.



850.316

Item No.	Machining-method	Number of specimens per set	Roughness <i>Ra</i> μm	Roughness <i>CLA</i> μm	Roughness class <i>N</i>	Price RUB
850.315	Surface grinding	8	0.025- 3.2	1- 125	1- 8	
850.316	Cylindr. grinding	8	0.025- 3.2	1- 125	1- 8	
850.319	Face turning	8	0.4 - 50	16- 2000	5-12	
850.320	Turning	8	0.4 - 50	16- 2000	5-12	
850.321	End milling	8	0.4 - 50	16- 2000	5-12	
850.322	Reaming & drilling	8	0.4 - 12.5	16- 500	5-10	
850.323	Horizontal milling	8	0.4 - 50	16- 2000	5-12	
850.325	Planing	8	0.8 -100	32- 4000	6-13	
850.331	Spark erosion	8	0.4 - 50	16- 2000	5-12	

Available with declaration of conformity on request.

Roughness specimens for blasted surfaces

- Each plate consists of four roughness specimens for grit and shot blasting, in 4 segments.
- Delivery in a solid, leather wallet.
- Standardized to ISO specifications.

Item No.	Description	Price RUB
850.017	Shot blasting	
850.018	Grit blasting	



850.018

019.2017 Technobearing 201 (9628)

Gauges / Pin gauges / Thread and tolerance tables



D12.001.
Technobearing 2019/06/25

Plug gauges

Manufactured according DIN 2245, 2246 and 2247. Available from 0.5 to 250 mm; up to 70 mm with Go and NoGo on one handle, over 70 mm in two parts. Prices are for H7 plug gauges with Go and NoGo ends in hardened steel.

- H7 fit size in hardened steel.
- Available from 0.5 to 160 mm; up to 70 mm with Go and NoGo on one handle, over 70 mm in two parts.
- Including wear allowance at the Go end.

Wear allowance

New gauges are supplemented with a wear allowance on the Go end: z (plus) for plug gauges. Accordingly, the size indicated on the handle is not similar to the measured value of the new Go end.

Example: plug gauge 20 H7

New Go end:

size	20.000 mm
wear allowance (+z)	<u>0.003 mm</u>
	20.003 mm
manufacturing tolerance	± 0.002 mm
largest value measured	20.005 mm
smallest value measured	20.001 mm

Also available:

- larger sizes,
- without wear allowance,
- many other fit sizes, like H6, H8, P7, G7 etc.,
- hard-chrome plated plug gauges,
- tungsten carbide plug gauges,
- extended plug gauges,
- plug gauges with vent hole,
- plug gauges with easy-entry pilot.



Measuring reports

For all gauges also measuring reports can be ordered.

- ① Inspection report (German) per gauge. Stating of product specifications, measured values after production, used traceable measuring devices, measuring inaccuracy and measuring date. A favourable choice when your quality system does not require traceable certificates.
- ② Traceable certificate (Dutch) with measuring reports of the ordered gauges. Besides stating of the measured values the extra assurance of an external inspection.

TECHNOBEARING

Size H7 mm	Price RUB	Size H7 mm	Price RUB	Size H7 mm	Price RUB	Size H7 mm	Price RUB	Size H7 mm	Price RUB
1		10		24		42		70	
1.5		11		25		44		72	
2		12		26		45		75	
2.5		13		27		46		78	
3		14		28		47		80	
3.5		15		30		48		82	
4		16		32		50		85	
4.5		17		33		52		88	
5		18		34		55		90	
5.5		19		35		58		92	
6		20		36		60		95	
7		21		37		62		98	
8		22		38		65		100	
9		23		40		68			

Larger sizes available on request.

Pin gauges in sets

Hardened steel pin gauges in sets with favourable price-performance ratio, very well suited for workshop use. Delivery in plastic case with a declaration of conformity and holder for Go/NoGo determination.

- Hardened steel.
- Diameter range: 0.50-20.00 mm.
- Increment: 0.01 mm.
- Accuracy: ± 0.003 mm.
- Without handle.
- Pin gauges $> \varnothing 1.5$ mm with size indication.
- Length: 50 mm.
- Delivery with a declaration of conformity.
- Delivery in a plastic case with pin gauges in separate plastic tubes with size indication.
- Delivery with holder with Go/NoGo indication.

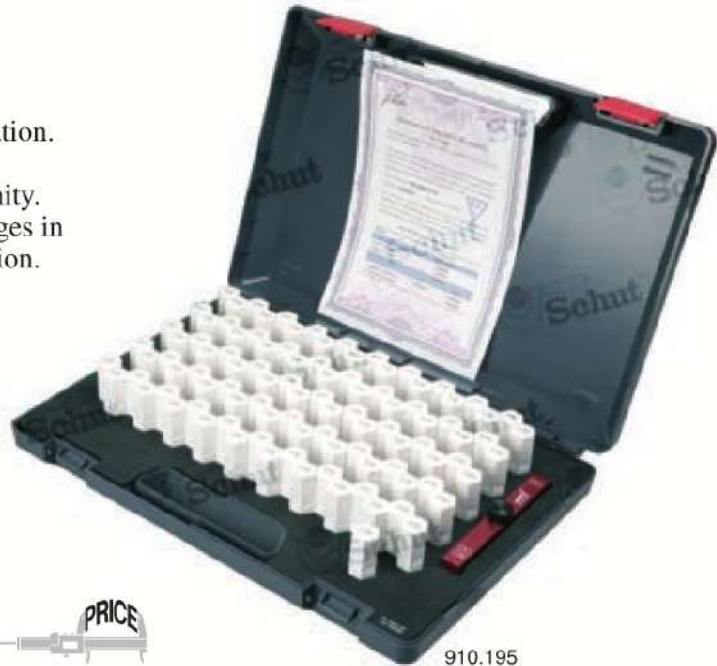

NEW



Item No.	Diameter mm	Increment mm	Number per set	Price RUB
910.193	0.50- 1.00	0.01	51	
910.194	1.00- 2.00	0.01	101	
910.195	2.00- 3.00	0.01	101	
910.196	3.00- 4.00	0.01	101	
910.197	4.00- 5.00	0.01	101	
910.198	5.00- 6.00	0.01	101	
910.199	6.00- 7.00	0.01	101	
910.200	7.00- 8.00	0.01	101	
910.201	8.00- 9.00	0.01	101	
910.202	9.00- 10.00	0.01	101	
910.203	10.00- 11.00	0.01	101	
910.204	11.00- 12.00	0.01	101	
910.205	12.00- 13.00	0.01	101	
910.206	13.00- 14.00	0.01	101	
910.207	14.00- 15.00	0.01	101	
910.208	15.00- 16.00	0.01	101	
910.209	16.00- 17.00	0.01	101	
910.210	17.00- 18.00	0.01	101	
910.211	18.00- 19.00	0.01	101	
910.212	19.00- 20.00	0.01	101	

Options:

- 910.213 Pin gauge handle Go-NoGo 0-13 mm
- 910.214 Pin gauge handle Go-NoGo 13-20 mm



TECHNOBEARING



012-306 Technobearing 201 (96628)

Pin gauges

Swiss made, hardened and ground steel pin gauges, conforms to DIN 2269; available **loose and in sets**.

- Hardened, ground, and seasoned steel (HV 760 ± 50).
- Diameter range:
without handle: 0.06-20.00 mm,
with handle: 0.06-10.00 mm.
- Increment: 0.01 mm.
- Accuracy: ±0.0015 mm.
- Pin gauges ø5.00-20.00 mm
without handle: indication on head.



Also available:

With an accuracy of ±0.0003 or ±0.001 mm;
– hardened steel ø0.06-20.00 mm,
– tungsten carbide or ceramics ø0.50-9.99 mm,
with 0.01 mm increments. The length may deviate. More information available on request.

Diameter/mm	Length/mm	Price RUB
Pin gauge without handle:		
0.06 - 0.09 ¹	30	
0.10 - 0.19 ¹	40	
0.20 - 0.29 ¹	40	
0.30 - 0.49 ¹	40	
0.50 - 0.99 ¹	40	
1.00 - 2.99	70	
3.00 - 4.00	70	
4.01 - 5.00	70	
5.01 - 5.99	70	
6.00 - 9.99	70	
10.00 - 11.99	70	
12.00 - 13.99	70	
14.00 - 15.99	70	
16.00 - 18.99	70	
19.00 - 20.00	70	
Pin gauge with handle²:		
0.06 - 0.09 ¹	23	
0.10 - 0.19 ¹	33	
0.20 - 0.29 ¹	33	
0.30 - 0.49 ¹	33	
0.50 - 0.99 ¹	33	
1.00 - 2.99	62	
3.00 - 4.00	62	
4.01 - 5.00	62	
5.01 - 5.99	62	
6.00 - 10.00	62	

Item No.	Description	Price RUB
Wooden case (tubes not included):		
833.211	For 50 pin gauges ø0.10 - 10.00 mm without handle	
833.704	For 100 pin gauges ø0.10 - 10.00 mm without handle	
833.264	For 50 pin gauges ø0.10 - 10.00 mm with handle	
833.118	For 40 pin gauges ø10.01 - 15.00 mm	
833.705	For 80 pin gauges ø10.01 - 15.00 mm	
833.706	For 30 pin gauges ø15.01 - 20.00 mm	
Pin gauge tube for pin gauges¹:		
833.066	Without handle up to ø0.99 mm	
838.224	Without handle ø1.00-7.00 mm	
838.089	With handle up to ø0.99 mm	

¹ For insert in wooden case.

TECHNOBEARING



¹ Delivery in plastic transport case.

² The length here indicates the measuring length and not the total length of the pin gauges.

D12.2DM Technobearing 201 (96628)

Pin gauges in sets

- Hardened, ground, and seasoned steel (HV 760±50).
- Diameter range: 0.10 - 10.00 mm.
- Increment: 0.01 mm.
- Accuracy: ±0.0015 mm.
- Without handle.
- Pin gauges ø 5.00 - 10.00 mm: indication on head.
- Length: ø 0.10 - 0.99 mm: 40 mm, ø 1.00 - 10.00 mm: 70 mm.
- Sets with larger diameters and/or with handle are available on request.



Item No.	Diameter mm	Increment mm	Number per set	Price* RUB
833.901	0.10- 1.00	0.01	91	
833.902	1.00- 2.00	0.01	101	
833.903	2.00- 3.00	0.01	101	
833.904	3.00- 4.00	0.01	101	
833.905	4.00- 5.00	0.01	101	
833.906	5.00- 6.00	0.01	101	
833.907	6.00- 7.00	0.01	101	
833.908	7.00- 8.00	0.01	101	
833.909	8.00- 9.00	0.01	101	
833.910	9.00- 10.00	0.01	101	
834.190	1.00- 10.00	0.10	91	



*Prices per set, in wooden case.

Pin gauges accessories

Interchangeable handles

- For pin gauges without handle.



Item No.	For diameter/mm	Price RUB
836.043	0.40- 0.80	
834.172	0.80- 1.30	
836.044	1.30- 1.80	
836.045	1.80- 2.30	
837.615	2.30- 2.80	
837.956	2.80- 3.30	
837.957	3.30- 3.80	
837.958	3.80- 4.30	
837.959	4.30- 4.80	
837.960	4.80- 5.30	

Holders for Go/NoGo determination

- For two pin gauges without handle.
- With NoGo indication.



Item No.	For diameter/mm	Price RUB
833.310	1.00- 2.00	
833.311	2.00- 4.00	
833.312	4.00- 6.00	
833.313	6.00- 8.00	
833.314	8.00- 10.00	

TECHNOBEARING



012.203 Technobearing 201 (9623)

Plug gauges

Ground and lapped, hardened tool steel plug gauges with a high accuracy. Available per piece and in sets. Swiss made.

- Diameter range: \varnothing 0.06 - 10.00 mm.
- Increment: 0.01 mm.
- Accuracy: \pm 0.0005 mm.
- Hardened tool steel (HV 760 \pm 50). Ground and lapped.
- Measuring length (and total length):
 - \varnothing 0.06 - 0.30 mm: 2 mm (34 mm),
 - \varnothing 0.31 - 0.50 mm: 3.5 mm (35.5 mm),
 - \varnothing 0.51 - 1.50 mm: 5 mm (37 mm),
 - \varnothing 1.51 - 2.00 mm: 6 mm (38 mm),
 - \varnothing 2.01 - 3.50 mm: 8 mm (43 mm),
 - \varnothing 3.51 - 6.00 mm: 10 mm (55 mm),
 - \varnothing 6.01 - 8.00 mm: 14 mm (59 mm),
 - \varnothing 8.01 - 10.00 mm: 18 mm (63 mm).
- Size indication on the insulated handle.
- Also available in tungsten carbide and ceramic with an accuracy of \pm 0.001 mm.



Per piece

Diameter/mm	Price RUB
0.06- 0.09	
0.10- 0.19	
0.20- 0.29	
0.30- 0.49	
0.50- 0.99	
1.00- 2.99	
3.00- 5.99	
6.00-10.00	

Sets

Item No.	Diameter mm	Pieces	Price RUB
833.761	0.06 - 0.50	45	
833.762	0.51 - 1.00	50	
833.763	1.01 - 1.50	50	
833.764	1.51 - 2.00	50	
833.765	2.01 - 2.50	50	
833.766	2.51 - 3.00	50	
833.767	3.01 - 3.50	50	
833.768	3.51 - 4.00	50	
837.311	4.01 - 4.50	50	
837.312	4.51 - 5.00	50	
837.313	5.01 - 5.50	50	
837.314	5.51 - 6.00	50	
837.315	6.01 - 6.50	50	
837.316	6.51 - 7.00	50	
837.317	7.01 - 7.50	50	
837.318	7.51 - 8.00	50	
837.319	8.01 - 8.50	50	
837.320	8.51 - 9.00	50	
837.321	9.01 - 9.50	50	
837.322	9.51 - 10.00	50	



TECHNOBEARING

Select setting rings

Setting rings, manufactured according DIN 2250 form C, 1 to 4 mm.

The size is indicated on the ring to three decimal places.

For all gauges also measuring reports can be ordered.



Item No.	Size/mm	Price RUB
830.001	1	
830.002	1.2	
830.003	1.5	
830.004	1.8	
830.005	2	
830.006	2.2	
830.007	2.5	
830.008	2.8	
830.009	3	
830.010	4	

Setting rings

Setting rings, manufactured according DIN 2250 form C, 1 to 315 mm.

- DIN 2250 form C.
- Material: hardened steel.
- The size is indicated on the setting rings to three decimal places to 100 mm. From 100 mm the nominal size is indicated in mm and separately the deviation in μm .
- Price on request up to 3 mm.

Also available:

- Higher accuracy,
- in tungsten carbide from 3 to 38 mm,
- form B rings for pneumatic measuring tools,
- intermediate and larger sizes,
- with coating,
- Go and NoGo limit ring gauges.



TECHNOBEARING

Size mm	Price RUB	Size mm	Price RUB	Size mm	Price RUB	Size mm	Price RUB	Size mm	Price RUB
1		18		43		80		165	
1.2		19		44		82		170	
1.5		20		45		84		175	
1.8		21		46		85		180	
2		22		47		86		185	
2.2		23		48		88		190	
2.5		24		49		90		195	
2.8		25		50		92		200	
3		26		52		94		210	
3.5		27		54		95		220	
4		28		55		96		230	
4.5		29		56		98		240	
5		30		58		100		250	
6		31		60		105		260	
7		32		62		110		270	
8		33		64		115		280	
9		34		65		120		290	
10		35		66		125		300	
11		36		68		130		310	
12		37		70		135		315	
13		38		72		140			
14		39		74		145			
15		40		75		150			
16		41		76		155			
17		42		78		160			

Intermediate sizes over 3 mm are also available

Measuring reports

For all gauges also measuring reports can be ordered.

- ① Inspection report (German) per gauge. Stating of product specifications, measured values after production, used traceable measuring devices, measuring inaccuracy and measuring date. A favourable choice when your quality system does not require traceable certificates.
- ② Traceable certificate (Dutch) with measuring reports of the ordered gauges. Besides stating of the measured values the extra assurance of an external inspection.

Thread gauges

The prices of the thread gauges apply to the following tolerances:

Kind of thread	Tolerances	
	Thread plug gauge	Thread ring gauge
Metric thread according ISO 1502 (DIN 13) up to and incl. M1.4 larger than M1.4	5H 6H	6h 6g (standard) 4h and 6e
Fixing pipe thread DIN EN ISO 228	center	A
Trapezoidal thread DIN 103	7H	7c

Other tolerances, sizes and kinds of threads are available on request; also available are special screw threads as per your design. Left-hand screw thread: price on request.



Measuring reports

For all gauges also measuring reports can be ordered.

- ① Inspection report (German) per gauge. Stating of product specifications, measured values after production, used traceable measuring devices, measuring inaccuracy and measuring date. A favourable choice when your quality system does not require traceable certificates.
- ② Traceable certificate (Dutch) with measuring reports of the ordered gauges. Besides stating of the measured values the extra assurance of an external inspection.

Thread plug and ring gauges

Hardened steel thread plug gauges (up to M39: Go + NoGo, from M42: Go and NoGo separate) and thread ring gauges (Go or NoGo) for metric screw thread (ISO) with coarse pitch. Manufactured according ISO 1502 (DIN 13).

Indication M...	Price RUB Thread plug	Price RUB Thread ring
1 x 0.25		
1.2 x 0.25		
1.4 x 0.3		
1.6 x 0.35		
1.8 x 0.35		
2 x 0.4		
2.2 x 0.45		
2.5 x 0.45		
3 x 0.5		
3.5 x 0.6		
4 x 0.7		
4.5 x 0.75		
5 x 0.8		
6 x 1		
8 x 1.25		
10 x 1.5		
12 x 1.75		
14 x 2		
16 x 2		
18 x 2.5		
20 x 2.5		
22 x 2.5		
24 x 3		
27 x 3		
30 x 3.5		
33 x 3.5		
36 x 4		
39 x 4		
Indication M...	Thread plug Go	Thread ring NoGo
42 x 4.5		
45 x 4.5		
48 x 5		
52 x 5		
56 x 5.5		
60 x 5.5		

Also most common sets available.

TECHNOBEARING

D12.2018 Technobearing 201 (RUB25)

Thread plug and ring gauges (continued)

Hardened steel thread plug gauges (Go + NoGo) and thread ring gauges (Go or NoGo) for metric screw thread (ISO) with pitch 0.5, 0.75, 1, 1.5. Manufactured according ISO 1502 (DIN 13).



Hardened steel thread plug gauges (up to 1 1/4": Go + NoGo, from 1 3/8": Go and NoGo separate) and thread ring gauges (Go or NoGo) for American screw thread UNC and UNF manufactured according ANSI B1.2 class 2B (thread plug) and BS 919 2A (thread ring; manufactured according ANSI B1.2 class 2A available on request).



Hardened steel thread plug gauges (up to G1": Go + NoGo, from G1 1/8": Go and NoGo separate) and thread ring gauges (Go or NoGo) for non-sealing fixing pipe thread. Manufactured according DIN EN ISO 228.



Hardened steel tapered thread plug and thread ring gauges NPT for sealing pipe thread. Manufactured according ANSI/ASME B1.20.1.



Hardened steel thread plug and thread ring gauges for sealing pipe thread. Manufactured according DIN 2999. DIN 2999 is replaced with DIN EN 10226 (ISO 7).



TECHNOBEARING

D12.209 Technobearing 201 (94628)

Thread plug and ring gauges in sets

Sets of thread plug gauges or thread ring gauges for inspection of metric ISO threads.

- For threads M3, M4, M5, M6, M8, M10 and M12.
- Tolerance class:
thread plug gauges: 6H,
thread ring gauges: 6g.
- Hardened steel, thread plug gauges with aluminum grip.
- Manufactured according ISO 1502 (DIN 13).
- Delivery in a wooden case with a traceable measuring report.



836.562



836.561



Item No.	Thread gauges set	Price RUB
836.561	Plug gauges (Go + NoGo)	
836.562	Ring gauges (Go)	
836.563	Ring gauges (NoGo)	

Plug gauges and setting rings in sets

- Hardened steel, plug gauges with aluminum grip.
- Set setting rings manufactured according DIN 2250 form C.
- Set plug gauges manufactured according DIN 2248/2249.
- Delivery in a wooden case with a traceable measuring report.

TECHNOBEARING



Item No.	Description	Price RUB
836.564	Setting rings: $\phi 4$, $\phi 5$, $\phi 6$, $\phi 8$ mm	
836.565	Setting rings: $\phi 10$, $\phi 12$, $\phi 16$, $\phi 20$, $\phi 25$ mm	
836.566	Plug gauges (Go + NoGo) H7: 3, 4, 5, 6, 8, 10, 12 mm	



D12.212. Technobearing 201 (94623)

Drill gauges

Gauge in the form of a steel plate with bores of increasing diameters for determining drill diameters.

- Increment: 0.1 mm.



836.640

TECHNOBEARING

Item No.	Measuring range/mm	Number of bores	Price RUB
836.640	0.1 - 10	100	
836.641	3 - 10	71	
856.545	15.1 - 17.5	25	
856.546	17.6 - 20	25	

Twist drill grinding gauges

For checking twist drills for the place and the 118° angle of the twist drill point. The maximum drill diameter is 50 mm.



856.441

Universal twist drill grinding gauge, also called *Y-gauge*. Besides the standard angle of 118°, this gauge also has a 90° angle for counter-sink drills, and some special angles for center drills.

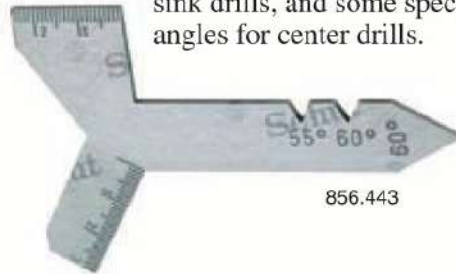

856.443

Item No.	Description	Price RUB
856.441	Twist drill grinding gauge	
856.443	<i>Y-gauge</i>	

Measuring wedges

Measuring wedges for quick measurements and checks of slits, key-ways, distances, etc.

- Measuring range: 0.4-26 mm.
- Graduation: 0.05, 0.1 or 0.2 mm.



909.537



909.535



909.536



856.331

Item No.	Measuring range/mm	Graduation mm	Price RUB
909.535	0.4- 6	0.05	
856.331	0.5-11	0.1	
909.536	1 -15	0.1	
909.537	2 -26	0.2	

PRICE

012.3D1. Technobearing 201 (9623)

Flat plug gauges

- Measuring range: 1-60 mm.
- Graduation: 0.1 mm.
- Stainless steel, no-glare chrome finished.
- Graduation on both sides.
- Ground measuring faces.



Item No.	Measuring range/mm	Price RUB
907.876	1 - 15	
909.516	15 - 30	
909.517	30 - 45	
909.534	45 - 60	



Conical plug gauges

- Measuring range: \varnothing 1-45 mm.
- Graduation: 0.1 mm.
- Hardened, ground and chrome finished.
- With anodized handle.



Item No.	Measuring range/mm	Price RUB
909.490	\varnothing 1 - 6	
909.491	\varnothing 4 - 15	
909.492	\varnothing 15 - 30	
909.493	\varnothing 30 - 45	

TECHNOBEARING



Nozzle gauges

Set of pins in holder serving as a gauge to determine jet nozzle sizes.



Item No.	Number of pins	Sizes mm	Price RUB
856.107	20	\varnothing 0.45 - 1.50	
856.108	16	\varnothing 1.50 - 3.00	
856.124	16	\varnothing 3.00 - 4.50	
856.125	16	\varnothing 4.50 - 6.00	

Nozzle gauges with vernier

Nozzle gauges with a hardened and ground tapered needle.

- Measuring range: \varnothing 0-5 mm.
- Vernier: 0.01 mm.



Item No.	Measuring range/mm	Price RUB
856.109	\varnothing 0-3	
856.110	\varnothing 0-5	

012.213 Technobearing 201 (9623)

Center gauges

For checking thread cutting tools for Whitworth thread 55° or metric thread 60°.

TECHNOBEARING



856.444



856.445

Item No.	Description	Price RUB
856.444	Whitworth 55°	
856.445	Metric 60°	

Thread cutting tool gauges



856.446



856.447



856.449

Item No.	Description	Price RUB
856.446	Universal thread cutting tool gauge for angular thread and flat thread	
856.447	Trapezoidal thread cutting tool gauge for trapezoidal thread DIN 103 (30°, 2-12 mm)	
856.449	Combined lathe and thread cutting tool gauge for – cutting tool wedge angle, – trapezoidal thread DIN 103 (30°, 2-12 mm), and – angular thread (40° - 80°)	
856.450	Combined lathe and thread cutting tool gauge like 856.449, with additional angle stop (0-30°) on the back	
856.451	Thread cutting tool gauge for – rectangular thread, – trapezoidal thread DIN 103 (30°, 2-12 mm), and – angular thread (55° and 60°)	



856.450



856.451

017.202. Technobearing 201 (9628)

Angle gauge set

- Measuring range: 5-90° (supplementary angles: 90-175°).
- Increment: 5° (18 pieces).
- Multiple angles per angle gauge:
 - primary angles (1, 2*, 3, 4),
 - supplementary angles (5, 6), and
 - 1/2 primary angles (7, 8).
- Delivery in a case.



* Angle 2: only with the angle gauges from 20°.



Item No.	Description	Price RUB
909.410	Angle gauge set	

Angle gauges

- Measuring range: 1-45°.
- Number of blades: 20.
- Angles: 1°-2°-3°-4°-5°-6°-7°-8°-9°-10°-12°-14°-16°-18°-20°-25°-30°-35°-40°-45°.



Item No.	Description	Price RUB
908.798	Angle gauges	

Radius gauges

- Measuring range radius: 1-25 mm.
- Increment:
 - 1-3 mm: 0.25 mm,
 - 3.5-20 mm: 0.5 mm,
 - >20 mm: 1.0 mm.

TECHNOBEARING



Item No.	Radius range/mm	Price RUB
907.766	1 - 7	
907.767	7.5 - 15	
907.768	15.5 - 25	

Shape and radius gauge

This stainless steel gauge can be used to adopt various complex shapes of tools and workpieces. When the gauge is pressed against the part which has to be checked, it takes on the shape of this part. Because of the graduation (mm) on the case, the shape can be checked easily.

Because the tracers were supported under pressure, they don't move on their own.



Item No.	Measuring range/mm	Price RUB
836.319	150x40	

017.204 Technobearing 201 (9625)

Set of welding seam gauges

- For weld thickness: 3 - 12 mm.
- Up to 7 mm increasing with 0.5 mm, plus 8, 10 and 12 mm.
- Total: 12 pieces.
- Bright steel.



Item No.	Description	Price RUB
856.452	Welding seam gauges	

Welding seam gauge

For measurement of welding seams.

- Graduation: 0.2 mm.
- Stainless steel.
- Delivery in a case.



Item No.	Description	Price RUB
856.438	Welding seam gauge	

Welding seam calipers

For measurement of welding seams.

- Measuring range: 0 - 20 mm.
- Analog: vernier 0.1 mm, digital: resolution 0.01 mm.
- Delivery in a case.

Analog

- Stainless construction.

Digital

- mm/inch conversion.
- On/off switch.
- Reset.
- Power supply: 1 battery type V357.

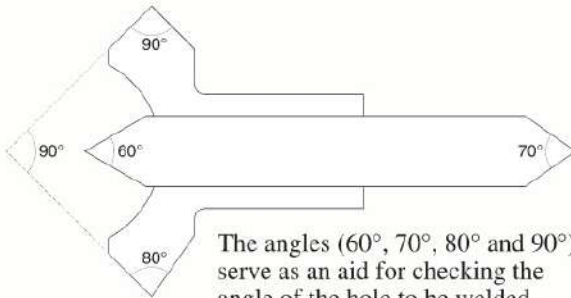
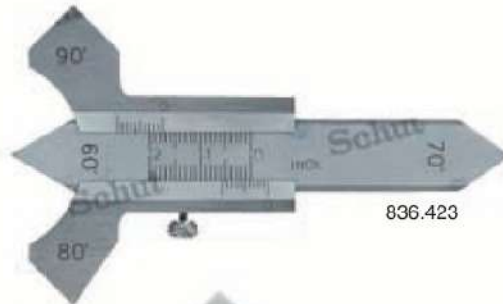

TECHNOBEARING

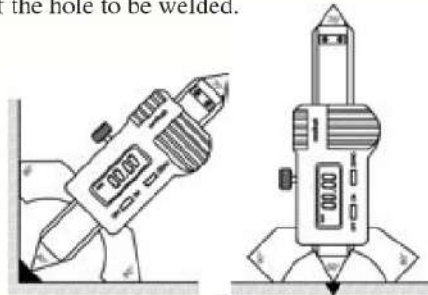

Item No.	Measuring range/mm	Price RUB
Analog: 836.423	0 - 20	
Digital: 906.429	0 - 20	
Option: 836.535	Spare battery	

Thread and tolerance tables

Thread table

Table with all standard international thread indications: metric, Ww, Gas, BSF, Pg, BA, UNC, UNF and UNEF.

Tolerance table

Table comprising all tolerances and fits according ISO R286, up to 500 mm (table with over 6400 pairs of tolerance values for internal and external measurements).

Conversion table mm/inch

For converting from mm to inch and from inch to mm.



Item No.	Description	Price RUB
835.162	Thread table	
835.163	Tolerance table	
835.164	Conversion table mm/inch	

Screw pitch gauges



Flat thickness gauge

Gauge to e.g. measure the thickness of steel plating.

- Measuring range: 1 - 13 mm.
- Graduation: 0.5 mm.
- Stainless steel.



Item No.	Measuring range/mm	Price RUB
907.899	1 - 13	

Item No.	Type of thread	Price RUB
856.456	Metric	
856.457	Whitworth	
856.458	BSP	
856.459	Metric/Whitworth	
856.460	Metric/Whitworth BSP	
856.461	UNC/UNF	

Universal meter for bevels

Universal instrument for measurement of bevels from 0.5 to 10 mm. Direct reading of the measured bevel (30°, 45°, 60°).

- Measuring range: 30°: 15 mm,
45°: 10 mm,
60°: 5 mm.
- Hardened stainless steel construction.
- Delivery in a case.



Item No.	Description	Price RUB
838.727	Universal meter for bevels	

012.214. Technobearing 201 (9623)

www.technobearing.ru

Magnifiers / Microscopes / Glass rulers / Stereo microscopes Endoscopes



013.0D0.
Technobearing 201 (96)23

Peak stand magnifier 5x

Standard, all-purpose magnifier.

- Dimensions: $\varnothing 35 \times 55$ mm.



Item No.	Price RUB
905.110	

Peak stand magnifier 10x

Standard, all-purpose magnifier. Very suitable for inspection of tissues, structures and photographic negatives.

- Dimensions: $\varnothing 34 \times 41$ mm.



Item No.	Price RUB
905.112	

Peak stand magnifier 10x

A simple, all-purpose magnifier.

- Dimensions: $\varnothing 41 / \varnothing 45 \times 40$ mm.

TECHNOBEARING



Item No.	Price RUB
905.316	

Peak stand magnifier 15x

Bright images with high contrast due to a coated achromatic lens. With wide acrylic tube.

- Dimensions: $\varnothing 27 / \varnothing 36 \times 33$ mm.



Item No.	Price RUB
905.114	

Peak stand magnifier 22x

Bright images with high contrast due to a coated achromatic lens. Suitable for inspection of high precision work.

- Dimensions: $\varnothing 28 \times 30$ mm.



Item No.	Price RUB
905.116	

013.201. Technobearing 201 (RUB)

Peak magnetic magnifier 5x

This magnifier has two small magnets which make sure that the magnifier can be put on a fixed position without moving. By placing this magnifier on hard to read scale divisions of, for example, graduated rulers, height gauges or micrometers, the possibility of reading errors substantially reduces.

- Field of view: \varnothing 30 mm.
- Dimensions: \varnothing 44 x 20 x 30 mm.
- Weight: 15 g.



Item No.	Description	Price RUB
905.210	Magnetic magnifier 5x	

Peak eye magnifiers 3.3x ... 20x

Eye magnifiers can be placed in front of the eye easily, which makes them ideal tools for working on small products like watches, clocks and jewelry.

- Made of aluminum.
- Weight: 10 - 16 g.
- A small hole in the tube prevents the lens from becoming blurred.



905.390



905.394



905.301

Item No.	Type	Magnification	Lenses	Price RUB
905.390	A13D	3.3x	1	
905.391	A16D	4.0x	1	
905.392	A20D	5.0x	1	
905.393	A26D	6.7x	1	
905.394	A40D	10.0x	2	
905.299	A48D	12.0x	1	
905.300	A60D	15.0x	1	
905.301	A80D	20.0x	1	

TECHNOBEARING

013.2012 Technobearing 201 (9623)

Peak zoom magnifiers 8-16x and 10-20x

Unique stepless zoom lens with sufficient brightness in each stage of magnification and a minimum of optical aberration. With click-stop on magnifications 8/10/12/14/16x and 10/15/20x, respectively. Equipped with scale.

- Field of view: ϕ 20 - 10 mm or ϕ 13 - 7 mm.
- Graduation: 0.1 mm.

TECHNOBEARING



905.198

905.197

Item No.	Magnification	Field of view ϕ /mm	Adjustment range eye correction	Measuring range/mm	Dimensions mm	Price RUB
905.197	8 - 16x	20 - 10	+2.5D to -5D	16	ϕ 45 x 65	
905.198	10 - 20x	13 - 7	+5D to -3.5D	12	ϕ 42 x 52	

Peak telecentric magnifier 7x

A telecentric magnifier shows objects, which are at different distances, with the same magnification. In this way 3D objects, or e.g. a needle above a scale, can be shown and measured accurately without parallax error.

- Field of view: ϕ 24 mm.
- Measuring range scale: 20 mm.
- Graduation: 0.1 mm.
- Adjustable diaphragm with apertures ϕ 0.5, 1 and 3 mm.
- Dimensions: ϕ 38 x 74 mm.



Item No.	Description	Price RUB
905.136	Telecentric magnifier 7x including case and standard scale (for scales of ϕ 26 mm)	

Peak stand magnifier 4x

This practical and convenient magnifier can be used for many purposes, like inspecting films. The magnifier is delivered with a clear and a black base, which allows you, depending on the amount of light, to choose the base which is most suitable for your application.

- Field of view: ϕ 45 mm.
- Dimensions: 51 x 51 x 65 mm.
- Weight: 80 g.



Item No.	Description	Price RUB
905.399	Stand magnifier 4x	

013.203 Technobearing 2019 06/23

Peak stand magnifier 8x

Convenient and smartly designed magnifier with achromatic lens. A scale is engraved at the bottom of the transparent acrylic base. Photographic negatives can be inspected using the base with opal glass.

- Field of view: 24 x 36 mm.
- Dimensions without base: 46 x 49 x 39 mm.
- Weight: 52 g.



Item No.	Description	Price RUB
905.290	Magnifier w/o base	
Option:		
905.291	Base	

Peak light magnifier 3.5x

Large square lens (52 x 52 mm) of plastic with illumination, e.g. for reading maps and indicators, and for inspection of production processes.

- Dimensions: 60 x 75 x 190 mm.
- Weight (without batteries): 120 g.
- Power supply: 2 batteries type C.



Item No.	Description	Price RUB
905.212	Magnifier (w/o batteries)	
Option:		
495.153	Battery (2 needed)	

Peak monocular telescopes

Lightweight pocket-size telescopes with erect image.

- Dimensions 905.207: ϕ 22.5 x 50 mm,
905.208: ϕ 22.5 x 53 mm.
- Weight: 32 g.
- Delivery in a case.

TECHNOBEARING



Item No.	Magnification	Lens aperture ϕ /mm	Close focus distance/mm	Field of view (angle)	Field of view* ϕ /mm	Field of view* ϕ /m	Price RUB
905.207	2x	8	100	11°	12	192	
905.208	4x	10	220	10°	29	175	

* Field of view respectively at close focus distance and at 1000 m.

013.204 Technobearing 201 (9623)

Peak head magnifiers 2.2x ... 5.2x

Because of the velcro strip, the head magnifier can be used easily. The great advantage of a head magnifier is that the user has both hands free for e.g. production and assembly of precision instruments. The head magnifier is designed in such a way that people who wear glasses can use it as well. With the extra pair of lenses inside the head magnifier, the magnification can be enhanced from 2.2x to 3.3x.

- Clear, broad and 3-dimensional view.
- Weight 905.318: 100 g,
905.317: 118 g.

905.318

905.317



Item No.	Magnification	Price RUB
905.318	2.2x / 3.3x	
905.317	2.2x / 3.3x / 4.1x / 5.2x	

Peak pen microscopes with EIM 25x ... 100x

These pen microscopes have a fixed scale and EIM system. With standard microscopes, the magnification is upside down, but because of the EIM system, this is not the case with these pen microscopes.

- Dimensions: ϕ 20.7 x 111 mm.
- Weight: 25 - 28 g.



905.404

Item No.	Magnification	Field of view ϕ /mm	Measuring range/mm	Graduation mm	Price RUB
905.404	25x	3.50	3.0	0.05	
905.405	50x	1.70	1.6	0.02	
905.406	75x	1.10	1.0	0.01	
905.407	100x	0.86	0.8	0.005	

TECHNOBEARING

Peak pen microscopes 25x ... 100x

- Dimensions: ϕ 12.4 x 127 mm.
- Weight: 13 - 16 g.
- With a fixed scale (only 905.263/264).



905.267

Item No.	Magnification	Field of view ϕ /mm	Measuring range/mm	Graduation mm	Price RUB
905.267	25x	3.30	-	-	
905.268	50x	2.00	-	-	
905.269	75x	1.09	-	-	
905.266	100x	0.84	-	-	
With fixed scale:					
905.263	25x	3.30	3.00	0.05	
905.264	50x	2.00	1.60	0.02	

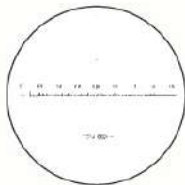

013.2015 Technobearing 201 (94625)

Peak light magnifiers 10x and 15x

Magnifier with illumination.

- Field of view: \varnothing 25 mm.
- Dimensions and weight (without batteries):
905.118: 175 x 35 x 41 mm, 81 g,
905.119: 180 x 36 x 42 mm, 90 g.
- Power supply: 2 batteries type C, not included.



Peak folding magnifiers 7x ... 20x

Steinheil magnifiers with an excellent chromatic correction and a large field of view.

- Dimensions: 39 x 24 x 22 mm.
- Weight: 18-22 g.



Item No.	Magnification	Price RUB
905.118	10x	
905.119	15x	
Option:		
495.153	Battery (2 needed)	

Item No.	Magnification	Field of view \varnothing /mm	Price RUB
905.200	7x	16	
905.202	10x	15.5	
905.204	14x	12	
905.206	20x	7	

Peak folding magnifiers 3x ... 9x

Because of their small size, these folding magnifiers are easy to use. Available in several magnifications, with one or two lenses. The advantage of two lenses is that it gives a very sharp image, because the image error of the first lens is being corrected by the second one.

A mm scale is engraved at each of the four sides of the base. The scale length is equal to the width of the field of view (see table).



Item No.	Magnification	Field of view/mm	Number of lenses	Material/color	Price RUB
905.230	9x	10 x 10	1	Al/clear	
905.375	7x	15 x 15	1	Al/clear	
905.376	6x	25 x 25	1	Al/clear	
905.377	9x	10 x 10	1	Al/black	
905.378	7x	15 x 15	1	Al/black	
905.379	6x	25 x 25	1	Al/black	
905.383	4x	30 x 30	2	Al/black	
905.384	3x	50 x 50	2	Al/black	
905.380	9x	10 x 10	2	Zn/black	
905.381	8x	15 x 15	2	Zn/black	
905.382	6x	25 x 25	2	Zn/black	

Peak scale magnifier 7x

All-purpose scale magnifier. Aberrations are avoided by the excellent achromatic lenses.

- Field of view: $\varnothing 26$ mm.
- Measuring range standard scale: 20 mm.
- Graduation: 0.1 mm.
- Dimensions: $\varnothing 36 \times 62$ mm.
- Weight: 56 g.



TECHNOBEARING



Scale magnifier with illumination 905.138

- Field of view: $\varnothing 22$ mm.
- Dimensions: $\varnothing 36 \times 58 \times 175$ mm.
- Weight (without batteries): 118 g.
- Power supply: 2 batteries type C.

Item No.	Description	Price RUB
905.140	Magnifier with standard scale in a case	
905.155	Set of magnifier 905.140 and five scales in a case	
905.138	Magnifier 905.140 with illumination (without batteries)	
Option:		
495.153	Battery (2 needed)	



Set 905.155

Scale magnifier 905.140 in a set with the five most frequently used scales (2, 3, 7, 8 and 10).

Peak scales $\varnothing 26$ mm

Aside from the standard scale, various other scales are available, each one with its own specific application. These scales are interchangeable in scale magnifiers like the one above.

Item No.	Scale	Price RUB
905.141	no. 1	
905.142	no. 2	
905.143	no. 3	
905.144	no. 4	
905.145	no. 5	
905.146	no. 6	
905.147	no. 7	
905.148	no. 8	
905.149	no. 9	
905.150	no. 10	
905.151	no. 11	
905.152	no. 12	
905.153	standard	

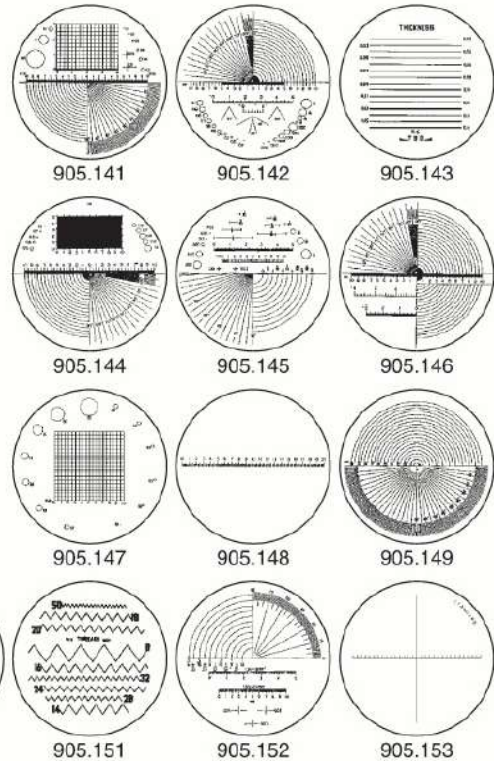

Peak scale magnifier 10x

All-purpose scale magnifier. Aberrations are avoided by the excellent achromatic lenses. High resolution and large field of view.

- Field of view: $\varnothing 35$ mm.
- Measuring range standard scale: 30 mm.
- Graduation: 0.1 mm.
- Dimensions: $\varnothing 46 \times 44$ mm.
- Weight: 74 g.



TECHNOBEARING



Scale magnifier with illumination 905.178

- Field of view: $\varnothing 32$ mm.
- Dimensions: $\varnothing 47 \times 45 \times 185$ mm.
- Weight (without batteries): 134 g.
- Power supply: 2 batteries type C.

Item No.	Description	Price RUB
905.180	Magnifier with standard scale in a case	
905.195	Set of magnifier 905.180 and five scales in a case	
905.178	Magnifier 905.180 with illumination (without batteries)	
Option:		
495.153	Battery (2 needed)	



Set 905.195

Scale magnifier 905.180 in a set with the five most frequently used scales (2, 3, 7, 8 and 10).

Peak scales $\varnothing 35$ mm

Aside from the standard scale, various other scales are available, each one with its own specific application. These scales are interchangeable in scale magnifiers like the one above.

Item No.	Scale	Price RUB
905.181	standard	
905.182	no. 1	
905.183	no. 2	
905.184	no. 3	
905.185	no. 4	
905.186	no. 5	
905.187	no. 6	
905.188	no. 7	
905.189	no. 8	
905.190	no. 9	
905.191	no. 10	
905.192	no. 11	
905.193	no. 12	

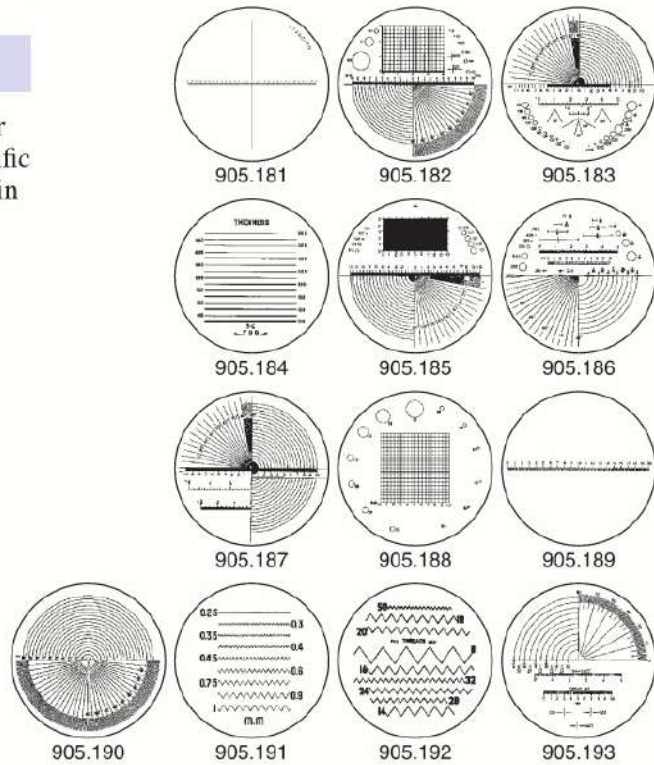

013.208 Technobearing 201 (9623)

Peak long-distance microscope

The long-distance microscope consists of a stand microscope 40x (905.330) and an objective unit. The objects being inspected can be enlarged sharply at a short distance of 200 mm as well as at long distances. The microscope has a large field of view, and comes with a Huygens eyepiece (magnification 10x) and a detachable soft rubber eye adapter.

- Focusing with helicoid ring.
- Dimensions at working distance
200 mm: $\varnothing 46 \times 316$ mm,
infinite: $\varnothing 46 \times 262$ mm.
- Weight: 414 g.
- Delivery in a case incl. standard scale.



Working distance/mm	Magnification	Field of view \varnothing /mm
200	27x	5.5
300	15x	10
400	10x	15
500	8x	19

Item No.	Description	Price RUB
905.435	Long-distance microscope	

Peak scale magnifier 3x

Scale magnifier with a lens system separated from the scale by a stand, hereby creating a larger working distance, field of view and luminous intensity. The scale is placed in a rotatable ring in the base of the stand.

- Field of view: $\varnothing 58$ mm.
- Measuring range scale: 54 mm.
- Graduation: 0.1 mm.
- Dimensions: 76 x 105 x 96 mm.
- Weight: 378 g.

TECHNOBEARING



Item No.	Description	Price RUB
905.328	Magnifier with scale and stand	

013.209 Technobearing 201 (9628)

Peak scale magnifier 30x

- Field of view: $\varnothing 7$ mm.
- Measuring range standard scale: 5 mm.
- Graduation: 0.05 mm.
- Dimensions: $\varnothing 30 \times 19$ mm.
- Weight: 16 g.

Scale magnifier with LED illumination 905.287

- Dimensions: $\varnothing 43 \times 65 \times 184$ mm.
- Weight (without batteries): 48 g.
- Power supply: 2 batteries type AAA.



NEW



Item No.	Description	Price RUB
905.285	Scale magnifier in case	
905.287	Magnifier 905.285 with illumination (without batteries)	
Options:		
497.914	Battery (2 needed)	
905.286	Separate standard scale	
905.179	LED penlight	

Peak anastigmatic scale magnifiers 4x and 7x

Magnifier with anastigmatic lens. This is a combined objective which reflects a large, undistorted image with sharp features, very suitable for inspection of (photographic) films.

- Large field of view, 905.216: $\varnothing 58$ mm,
905.400: $\varnothing 41$ mm.
- Removable scale with mm graduation.
- Measuring range scale 905.217: 54 mm,
905.401: 36 mm.
- Graduation scale: 0.1 mm.
- Dimensions and weight:
905.216: $\varnothing 73 \times 77$ mm, 272 g,
905.400: $\varnothing 55 \times 53$ mm, 103 g.



905.216



905.400

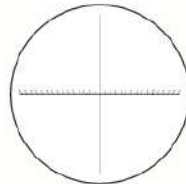

TECHNOBEARING

Item No.	Description	Price RUB
905.216	Scale magnifier 4x	
905.400	Scale magnifier 7x	
Options:		
905.217	Standard scale for magnifier 905.216	
905.401	Standard scale for magnifier 905.400	

013.210. Technobearing 201 (9623)

Peak scale magnifier 15x

- Field of view: $\varnothing 20$ mm.
- Measuring range standard scale: 14 mm.
- Graduation: 0.1 mm.
- Dimensions: $\varnothing 35 \times 33$ mm.
- Weight: 40 g.

NEW

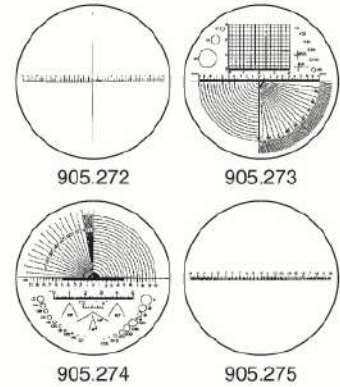

Item No.	Description	Price RUB
905.270	Magnifier with standard scale in a case	
905.278	Magnifier 905.270 with illumination (without batteries)	
Options:		
497.914	Battery (2 needed)	
905.272	Separate standard scale	
905.273	Scale no. 1	
905.274	Scale no. 2	
905.275	Scale no. 8	
905.179	LED penlight	

Scale magnifier with LED illumination 905.278

- Dimensions: $\varnothing 43 \times 65 \times 184$ mm.
- Weight (without batteries): 72 g.
- Power supply: 2 batteries type AAA.



Peak stand magnifier 30x

This *microscopic* magnifier has a very high magnification despite its small size. In this way, the magnifier can be held with one hand, while you can hold the product to be inspected in the other. Because of the sophisticated optic design, this magnifier is almost comparable to a microscope of the same size, while the field of view is larger. This magnifier is often used in photo technique, for the production of precision instruments and for inspection of precision work.

- Lens aperture: $\varnothing 7$ mm.
- Dimensions: $\varnothing 37 \times 20$ mm.
- Weight: 10 g.



TECHNOBEARING

NEW



Stand magnifier with LED illumination 905.402

- Dimensions: $\varnothing 43 \times 65 \times 184$ mm.
- Weight (without batteries): 40 g.
- Power supply: 2 batteries type AAA.

Item No.	Description	Price RUB
905.222	Stand magnifier $M = 30x$	
905.402	Stand magnifier 905.222 with illumination (without batteries)	
Options:		
497.914	Battery (2 needed)	
905.179	LED penlight	

013.211. Technobearing 201 (9625)

Peak ABC magnifier 3-18x

The ABC magnifier consists of three lenses. Combining the three lenses, seven different magnifications are possible.

- Magnification: 3x, 6x, 9x, 12x, 14x, 16x and 18x.
- Magnification and diameter of the lenses:
 lens A: 12x, ϕ 14 mm,
 lens B: 3x, ϕ 28 mm,
 lens C: 6x, ϕ 20 mm.
- Dimensions: 60 x 39 x 24 mm.
- Weight: 76 g.



Item No.	Description	Price RUB
905.196	ABC magnifier 3-18x	

Peak magnifying glass 2.5-5x

This model of the classical magnifying glass has a lens-in-lens construction. In the big ϕ 75 mm lens a smaller ϕ 20 mm lens has been integrated which offers extra strong magnification. The big lens has a 2.5x magnification, the small lens 5x.

- Dimensions: ϕ 80 x 170 mm.
- Weight: 111 g.



Item No.	Description	Price RUB
905.214	Magnifying glass 2.5 - 5x	

Magnifier on magnetic stand

- Magnification: 2x (ϕ 90 mm).
- Total length: 280 mm.
- Magnetic force: 600 N.



Item No.	Description	Price RUB
909.609	Magnifier on magnetic stand	

Peak flexible stand magnifier

This magnifier has a flexible arm which can be adjusted freely from a solid and stabilized stand. The lens can be put in many positions for the most ergonomic use thus leaving both hands of the user free.

- Dimensions:
 145 x 120 x 485 mm
 (maximum height).
- Weight: 1.5 kg.



Item No.	Magnification	Lens ϕ /mm	Price RUB
905.279	1.7x	115	
905.427	2.0x	100	
905.428	2.2x	90	

Peak stand microscopes 20x ... 300x

These stand microscopes are available in five versions. All five are compact and lightweight, but are especially characterized by their large field of view. Delivery in a case, including LED illumination, matching standard scale and objective. The microscopes come with a Huygens eyepiece (magnification 10x) and with a detachable soft rubber eye adapter. All-purpose use with high precision.



Type 2034

A scale graduation (with a 10 mm scale range) has been engraved on the focusing ring which allows height measurements at a resolution of 0.1 mm.

- Focusing with helicoid ring.
- Dimensions: $\phi 63 \times 172$ mm.
- Weight (without batteries): 237-241 g.
- Power supply: 2 batteries type AAA.

Item No.	Magnification	Field of view ϕ /mm	Working distance/mm	Measuring range/mm	Graduation mm	Price RUB
905.320	20x	7.2	36	6	0.1	
905.330	40x	3.6	18.7	3	0.05	
905.340	60x	2.4	10.8	2	0.02	
905.350	100x	1.45	5.7	1.2	0.01	
905.355	150x	0.96	9.2	0.9	0.005	
905.370	200x	0.72	6.7	0.6	0.002	
905.374	300x	0.48	4	0.4	0.001	

Options:

497.914	Spare battery (2 needed)
905.179	LED penlight

Peak individual scales

The in the eyepiece integrated scale can be changed, for example when the magnification of the microscope changes (see "Individual objectives"). Additionally, an extra eyepiece (without scale and soft rubber eye adapter) is available, so the eyepiece doesn't need to be disassembled each time the scale is being changed.

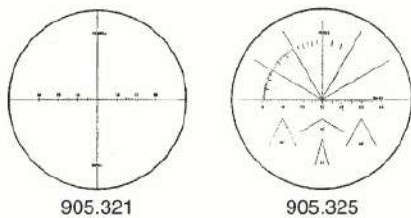

Item No.	Magnification microscope	Scale	Price RUB
Standard scales:			
905.321	20x	no. 54	
905.331	40x	no. 64	
905.341	60x	no. 74	
905.351	100x	no. 84	
905.356	150x	no. 94	
905.337	200x	no. 104	
905.388	300x	no. 114	
For inspection of printed matter and tools:			
905.325	20x	no. 55	
905.335	40x	no. 65	
904.042	Individual eyepiece 10x		

Peak stand microscopes 20x ... 300x (continued)

Types 2054/2054-EIM/2064-CIL

These types primarily differ from the type 2034 in the focusing mechanism and the sturdy die-cast aluminum base.

- Focusing with rack-and-pinion.
- Dimensions: $\varnothing 63 \times 172$ mm.
- Weight (without batteries):
 2054/2054-EIM: 263 - 267 g,
 2064-CIL: 393 - 394 g.
- Power supply:
 2054/2054-EIM: 2 batteries type AAA,
 2064-CIL: 2 batteries type AAA and
 2 batteries type AA.



Type 2064-CIL



Type 2054-EIM

Coaxial Incident Light (CIL)

The microscope of the type 2064-CIL are besides the standard LED illumination also provided with a coaxial light source, which is especially suitable for the inspection of objects with deep structures as well as chromed, high reflective surfaces.

Erected Image with Measure (EIM)

With standard microscopes, the magnification is upside down, but this is not the case with the microscopes of type 2054-EIM.

Peak individual objectives

The objectives are also separately available. This gives you the great advantage that you can get all magnifications with one scale microscope. The magnification of the eyepiece is 10x.

Item No.	Magnification objective	Magnification microscope	Price RUB
905.322	2x	20x	
905.332	4x	40x	
905.342	6x	60x	
905.352	10x	100x	
905.357	15x	150x	
905.372	20x	200x	
905.387	30x	300x	

Item No.	Magnification	Price RUB
Type 2054:		
905.410	20x	
905.411	40x	
905.412	60x	
905.413	100x	
905.414	150x	
905.415	200x	
905.416	300x	
Type 2054-EIM:		
905.417	20x	
905.418	40x	
905.419	60x	
905.420	100x	
Type 2064-CIL:		
905.293	40x	
905.294	60x	
905.295	100x	
905.296	150x	
905.297	200x	
905.298	300x	
Options:		
497.914	Spare battery type AAA (2 needed)	
495.111	Spare battery type AA (2 needed)	
905.179	LED penlight	

For other specifications: see table of type 2034.

013.214. Technobearing 201 (9623)

Peak stand microscopes 25x ... 100x

Compact and light-weight stand microscope with scale. The high resolution and bright images as well as its easy focusing make this instrument a practical measuring aid. A scale graduation (scale range 8 mm) has been engraved on the focusing ring which allows height measurements at a resolution of 0.1 mm. With detachable soft rubber eye adapter. Delivery in a case, with matching standard scale.

- Dimensions: $\varnothing 41.5 \times 122$ mm.
- Weight: 83 g.

TECHNOBEARING

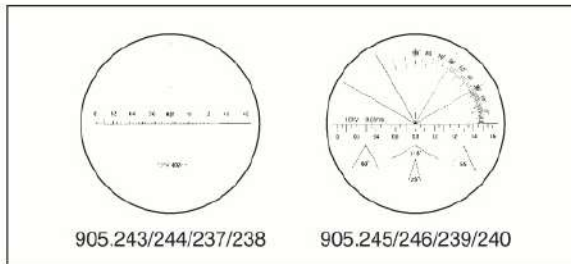

905.243/244/237/238

905.245/246/239/240



905.250

Item No.	Type	Magnification	Price RUB
Standard scales:			
905.243	24	25x	
905.244	13	50x	
905.237	34	75x	
905.238	44	100x	
Scales for inspection of printed matter and tools:			
905.245	25	25x	
905.246	14	50x	
905.239	35	75x	
905.240	45	100x	

Item No.	Magnification	Field of view \varnothing /mm	Working distance/mm	Measuring range/mm	Graduation mm	Price RUB
905.249	25x	3.3	17.0	3.0	0.05	
905.250	50x	2.0	11.7	1.6	0.02	
905.251	75x	1.1	11.7	1.0	0.01	
905.258	100x	0.84	11.6	0.8	0.005	

013.215 Technobearing 201 (9625)

Peak glass rulers

- Graduation: 0.1 mm.
- Accuracy: ±0.02 mm.
- Thickness: 10 mm.
- Width: 50 mm.
- Delivery incl. 2 magnifiers $M=10x$.
- Delivery in a case.



Item No.	Measuring range/mm	Length mm	Price RUB
905.422	0- 300	360	
905.423	0- 500	560	
905.424	0- 700	760	
905.425	0-1000	1060	

Special cleaner

Special cleaner (120 ml) for objectives, glass plates and other optical components.



Item No.	Description	Price RUB
111.534	Special cleaner	

Field of view qualifier

Glass reference standard with a pattern consisting of wide variety of very accurate optical characteristics, produced with a coating (chrome). Very suitable for use with optical instruments as geometric accuracy standard or as a test and training object.

- Accuracy: ±0.002 mm.
- Delivery including drawing with size indication.



Item No.	Description	Price RUB
635.222	Field of view qualifier	

Optical cleaning kit

This cleaning kit is ideal to clean optics, microscopes and magnifying glasses, and can also be used on other products.

The set consists of:

- a bottle of cleaning solution (15 ml),
- a micro fiber cleaning cloth,
- a soft brush,
- an air blower.



Item No.	Description	Price RUB
909.432	Optical cleaning kit	

Light magnifiers with fluorescent or LED illumination

Large lens with a large field of view. Very suitable for production and assembly of precision instruments.

- Magnification: 1.75x.
- Lens: ϕ 120 mm (909.649: ϕ 100 mm).
- Span table clamp: 50 mm.
- Power supply: 230 V.



With circular fluorescent tube

Item No.	Description	Price RUB
909.650	With table clamp	
909.651	With base	
909.654	Spare bulb 22 W	

With LED ring light

Item No.	Description	Price RUB
909.648	90 LEDs, with table clamp	
909.649	60 LEDs, with base	

Stereo microscope SSM

- Magnification: 20x.
- Field of view: ϕ 9.5 mm.
- Viewing angle: 90°.
- Interpupillary distance: adjustable (55-75 mm).
- Working distance: 70 mm.
- Max. object height: 30 mm.
- Incident light (LED).



- Stage plate: white plastic, ϕ 50 mm.
- Dimensions *l* x *w* x *h*: 135 x 120 x 230 mm.
- Power supply: 2 batteries type AA.

Item No.	Type	Magnification	Price RUB
909.012	SSM	20x	
Option:			
495.111	Spare battery (2 needed)		

TECHNOBEARING

Stereo microscopes SSM-2

Stereo microscopes on a column stand, with a sharp erect image and a large field of view. The magnification is 20x (eyepiece: 10x, objective: 2x); eyepieces 5x, 15x and 20x are optionally available. See for all accessories the pages "SSM stereo microscope accessories".

- Viewing angle: 45°.
- Interpupillary distance: adjustable (55-75 mm).
- Left eyepiece with diopter adjustment: ±5 dpt.
- Objective: with dovetail mounting.
- Stage plate: black/white (two-sided).
- Delivery incl. dust cover and soft rubber eye adapters.

Item No.	Type	Magnification	Price RUB
909.000	SSM-2A	20x	
909.001	SSM-2C	20x	

See for accessories the pages "SSM stereo microscope accessories".



909.000



909.001

Type		SSM-2A	SSM-2C
Eyepiece	M	10x	10x
Objective	M	2x	2x
Total range*	M	10-40x	10-40x
Illumination		no	yes
Working distance	mm	70	70
Max. object height	mm	60	70
Travel of rack	mm	40	40
Stage plate	ø/mm	60	95
Dimensions	lxwxh/mm	220x115x250	220x115x290
Weight	kg	1.6	2.6

*The magnification range of the microscope in combination with the optional eyepieces 5-20x.

Illumination: incident light and backlight

Model SSM-2C is equipped with incident light and backlight (switchable incident light or backlight).

- Stage plate: opal glass. Delivery incl. black/white stage plate. Dark field condenser optional.
- Power supply: 230 Vac (50 Hz).

TECHNOBEARING

013.3D4 Technobearing 201 (RUB25)

Stereo zoom microscopes SSM-3/5

Stereo zoom microscopes with a sharp erect image and a large field of view. Equipped with a double objective (2x/4x is used most; also available 1x/2x and 1x/3x), so that the magnification can be changed with a simple rotary motion. The magnification of the eyepieces is 10x (optionally 5x, 15x and 20x). See for all accessories the pages "SSM stereo microscope accessories".

- SSM-3: stand with round column.
SSM-5: fixed stand.
- Microscope head: 360° rotatable (only SSM-5).
- Viewing angle: 45°.
- Interpupillary distance: adjustable (55 - 75 mm).
- Left eyepiece with diopter adjustment: ±5 dpt.
- Stage plate: black/white (two-sided).
- Delivery incl. dust cover and soft rubber eye adapters.

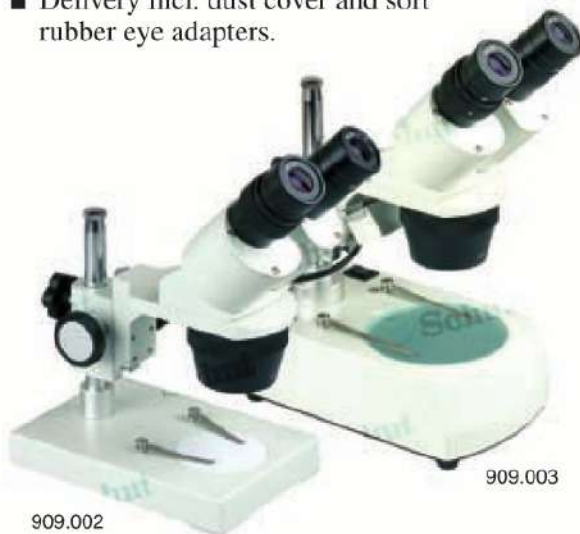

909.003

909.002

Illumination: incident light and backlight

Models SSM-3C/5CW are equipped with incident light and backlight (switchable incident light or backlight).

- Stage plate: opal glass. Delivery incl. black/white stage plate. Dark field condenser optional.
- Power supply: 230 Vac (50 Hz).

Item No.	Type	Magnification	Price RUB
909.002	SSM-3A	20x/40x	
909.042	SSM-3A	10x/20x	
909.032	SSM-3A	10x/30x	
909.003	SSM-3C	20x/40x	
909.043	SSM-3C	10x/20x	
909.033	SSM-3C	10x/30x	
909.034	SSM-5AW	20x/40x	
909.044	SSM-5AW	10x/20x	
909.004	SSM-5AW	10x/30x	
909.045	SSM-5CW	10x/20x	
909.035	SSM-5CW	10x/30x	

See for accessories the pages "SSM stereo microscope accessories".



909.004

909.045

Type		SSM-3A	SSM-3C	SSM-5AW	SSM-5CW
Eyepiece	M	10x	10x	10x	10x
Objective	M	2x/4x, 1x/2x or 1x/3x			
Total range*	M	10-80x, 5-40x or 5-60x			
Illumination		no	yes	no	yes
Working distance	mm	57	57	70	70
Max. object height	mm	60	70	20	20
Travel of rack	mm	40	40	30	20
Stage plate	ø/mm	60	95	60	95
Dimensions	lxwxh/mm	220x115x250	220x115x290	220x115x280	220x115x320
Weight	kg	1.7	2.6	1.7	2.5

*The magnification range of the microscope in combination with the optional eyepieces 5-20x.

TECHNOBEARING

Stereo zoom microscopes with auxiliary lenses SSM-10/20

Stereo zoom microscopes with a sharp erect image and a large field of view. Equipped with a double objective (2x/4x is used most; also available 1x/2x and 1x/3x), so that the magnification can be changed with a simple rotary motion. The magnification of the eyepieces is 10x (optionally 5x, 15x and 20x). The magnification can be adjusted to your application even more with an optional auxiliary lens (0.5x, 0.75x, 1.5x or 2x). See for all accessories the pages "SSM stereo microscope accessories".

- Stand with round (flattened) column and anti drop facility.
- Microscope head: 360° rotatable.
- Viewing angle: 45°.
- Interpupillary distance: adjustable (55 - 75 mm).
- Left eyepiece with diopter adjustment: ±5 dpt.
- Working distance (without aux. lens): 72 mm.
- Stage plate: black/white (two-sided).
- Delivery incl. dust cover and soft rubber eye adapters.

Item No.	Type	Magnification	Price RUB
909.006	SSM-10	20x/40x	
909.046	SSM-10	10x/20x	
909.036	SSM-10	10x/30x	
909.007 ¹	SSM-20C2	20x/40x	
909.047 ¹	SSM-20C2	10x/20x	
909.037 ¹	SSM-20C2	10x/30x	

¹ With LED illumination.
See for accessories the pages "SSM stereo microscope accessories".

TECHNOBEARING

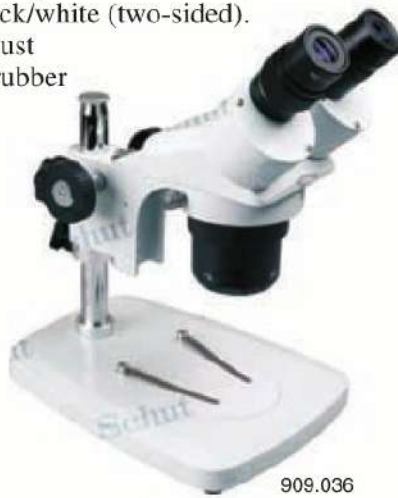

NEW

Illumination: LED incident light and LED backlight

Model SSM-20C2 is equipped with LED incident light and LED backlight, and the luminous intensity is adjustable.

- Stage plate: opal glass. Delivery incl. black/white stage plate.
- Power supply: 230 Vac (50 Hz).

Type		SSM-10	SSM-20C2
Eyepiece	M	10x	10x
Objective	M	2x/4x, 1x/2x or 1x/3x	
Total range*	M	5-160x, 2½-80x or 2½-120x	
Illumination		no	yes
Max. object height	mm	100	100
Travel of rack	mm	60	60
Stage plate	ø/mm	75	95
Dimensions	lxwxh/mm	260x170x290	270x235x330
Weight	kg	3.0	4.3

* The magnification range of the microscope in combination with the optional eyepieces 5-20x and auxiliary lenses 0.5-2x.



PRICE

Stereo microscopes with stepless zoom SSM-E

Stereo zoom microscopes with a sharp erect image and a large field of view. The special microscope head is equipped with stepless zoom; in combination with the standard 10x eyepieces (optionally 20x) you can smoothly zoom in from 10x to 40x magnification. The magnification can be adjusted to your application even more with an optional auxiliary lens (0.5x, 0.75x, 1.5x or 2x). See for all accessories the pages "SSM stereo microscope accessories".

- Stand with round (flattened) column and anti drop facility.
- Microscope head: 360° rotatable.
- Viewing angle: 45°.
- Interpupillary distance: adjustable (55 - 75 mm).
- Both eyepieces with diopter adjustment: ±5 dpt.
- Working distance (without aux. lens): 85 mm.
- Equipped with LED incident light and LED backlight, and the luminous intensity is adjustable.
- Stage plate: opal glass.
- Delivery incl. dust cover, soft rubber eye adapters and black/white stage plate.
- Power supply: 230 Vac (50 Hz).

Item No.	Type	Magnification	Price RUB
909.010	SSM-EC2	10-40x	
908.998	SSM-3EC2	10-40x	

See for accessories the pages "SSM stereo microscope accessories".



Type		SSM-EC2	SSM-3EC2
Eyepiece	M	10x	10x
Objective	M	1-4x	1-4x
Total range*	M	5-160x	5-160x
Illumination		yes	yes
Max. object height	mm	110	110
Travel of rack	mm	60	60
Stage plate	ø/mm	95	95
Dimensions	lxwxh/mm	330x235x360	330x235x395
Weight	kg	4.8	5.4

*The magnification range of the microscope in combination with the 10x eyepieces, the optional 20x eyepieces and the optional auxiliary lenses 0.5-2x.

NEW

Camera connection

Model 3EC2 is equipped with camera connection. See the accessories page for the total magnification range with camera.

013.307. Technobearing 201 (RUB)

SSM stereo microscope accessories

USB microscope cameras

For viewing and saving images. They fit in the ocular (ø30 mm) of an SSM microscope and/or the adapter bushing (ø23 mm) of the models SSM-3E/3EC2.

- Field of view: see table.
- Resolution: 1.3 Mpx or 5 Mpx.
- Suitable for Windows and Mac OS X.
- Measuring of distances, radii and angles.

Auxiliary lenses

The magnification can be adjusted to your application even more with an optional auxiliary lens. Note concerning stereo microscopes with a fixed stand: auxiliary lens 0.5x is not suitable, and with auxiliary lenses 1.5x and 2x focusing on the stage plate is not possible (the product needs to be positioned higher).



Pairs of eyepieces



Soft rubber eye adapters

Item No.	Description	Price RUB
909.089	Per pair	



TECHNOBEARING

Item No.	Description	Price RUB
Pairs of eyepieces for SSM-2/3/5/10/20:		
909.050	M=5x	
909.051	M=10x	
909.052	M=15x	
909.053	M=20x	
Pairs of eyepieces for SSM-E:		
909.055	M=10x	
909.057	M=20x	
Eyepieces with crosshair for SSM-E:		
909.095	M=10x (per piece)	
909.096	M=20x (per piece)	
Auxiliary lenses (for SSM-10/20/E):		
909.018	M=0.5x	
909.019	M=0.75x	
909.020	M=1.5x	
909.021	M=2x	
USB microscope cameras:		
774.145	1.3 Mpx, ø23 mm	
774.146	1.3 Mpx, ø23/30/30.5 mm	
774.243*	5 Mpx, ø23/30/30.5 mm	

* For displaying the 5 Mpx resolution a Motion JPEG codec is required.

PRICE

Magnification objective	Microscope magnification / Field of view/mm			
	Eyepiece 5x	Eyepiece 10x	Eyepiece 15x	Eyepiece 20x
Stereo microscope SSM-2:				
2x	10x / ø10.0	20x / ø10.0	30x / ø7.0	40x / ø5.0
Stereo zoom microscope SSM-3/5:				
1x	5x / ø20.0	10x / ø20.0	15x / ø15.0	20x / ø10.0
2x	10x / ø10.0	20x / ø10.0	30x / ø7.0	40x / ø5.0
3x	15x / ø7.0	30x / ø7.0	45x / ø5.0	60x / ø3.5
4x	20x / ø5.0	40x / ø5.0	60x / ø3.5	80x / ø2.5
Stereo zoom microscope SSM-10/20 (without auxiliary lens):				
1x	5x / ø20.0	10x / ø20.0	15x / ø15.0	20x / ø10.0
2x	10x / ø10.0	20x / ø10.0	30x / ø7.0	40x / ø5.0
3x	15x / ø7.0	30x / ø7.0	45x / ø5.0	60x / ø3.5
4x	20x / ø5.0	40x / ø5.0	60x / ø3.5	80x / ø2.5

Magnification objective	Magnification / Field of view/mm		Field of view camera/mm		
	Eyepiece 10x	Eyepiece 20x	774.145	774.146	774.243
Stereo microscope with stepless zoom SSM-E (without auxiliary lens):					
from 1x to 4x	10x / ø20.0 40x / ø5.0	20x / ø10.0 80x / ø2.5	4.5x3.3 ¹ 1.2x0.8 ¹	6.8x5.0 ¹ 1.4x1.0 ¹	19.0x14.0 ¹ 2.7x2.0 ¹
from 1x to 4x				5.6x4.1 ² 1.34x1.0 ²	18.0x12.0 ² 2.4x1.8 ²

¹ Camera intake in adapter bushing.
² Camera intake in ocular.

013.308 Technobearing 2019 (RUB)

SSM stereo microscope accessories (continued)

LED optical fiber illumination



Item No.	Description	Price RUB
LED optical fiber illumination:		
910.107	Light source LED, 20 W	
909.030	Single flexible arm	
909.028	Dual flexible arm	
909.029	Optical fiber ring light ^{1,2}	

LED optical fiber ring light^{1,2}

Suitable for stereo microscopes SSM-10/20/E.
Note: not for use in combination with auxiliary lenses.



Ring lights^{1,2}:		
909.024	Circular fluoresc. tube 10 W	
909.059	Spare bulb for 909.024	
909.085	Ring light 60 LEDs	

Spare bulbs (standard illumination):		
499.377	For SSM-2/3/5	
498.157	For SSM-20W/EW and for transmitted light SSM-3E	
499.379	For incident light SSM-3E	
438.211	Fuse F 0.5 A, 250 V for SSM-2/3/5/20W/EW/3E	



Other options:		
909.022	Dark field condenser	
908.999	XY measuring table	
960.255	Dial indicator holder	
635.222	Field of view qualifier	

Ring lights^{1,2}

Suitable for SSM-10/20/E (909.085) or SSM-3/5/10/20/E (909.024).

¹ Delivery incl. adapter ring.
² Note: microscopes with standard provided incident light, this incident light must be removed before installing the ring light.

Dark field condenser

The contrast of transparent objects is enhanced. Suitable for all SSM stereo microscopes with backlight.

- Diameter: 94 mm.
- Stage: ø27 mm.



Dial indicator holder

Suitable for stereo microscopes with round column from the series SSM-10/20/E, for height measurements. The accuracy increases with higher magnification.

- Excl. dial indicator.
- The travel of the microscopes is 60 mm; see the dial indicators category for a suitable dial indicator with measuring range 50 or 60 mm.

NEW

XY measuring table

- Range: X, Y: 25 mm.
- Intake microscope: ø94 mm.
- Turnable object plate with degree indication.
- Excl. two analog micrometer heads (intake ø12 mm; 906.072 measuring range 25 mm).



Field of view qualifier

- Accuracy: ±0.002 mm.

635.222



013.310. Technobearing 201 (9625)

SSM stereo microscope accessories (continued)

Large stand

- Base: 255 x 255 mm.
- Column height: 390 mm.
- Arm length: 490 mm.
- Height adjustment: 60 mm.



908.997

Stand with illumination

Equipped with LED incident light and back-light. The luminous intensity is adjustable.

- Column height: 185 mm.



909.405

LCD microscope head

- Screen: 8" color.
- CCD: 1/3" color.
- Zoom lens: 0.65 - 5.5.
- Magnification: 10 - 85x.
- Working distance: 10.5 cm.
- Crosshair can be toggled on/off.
- Field of view: from 1.3 x 1.8 mm (M=85x) to 12 x 16 mm (M=10x).



909.406

Microscope heads

- With or without camera connection.



909.093



909.092



909.405
+909.406
+870.006
+334.695

Item No.	Description	Price RUB
Microscope stands:		
908.997	Large stand	
909.405	Stand with illumination	
870.006 ¹	Column 400 mm	
Microscope heads:		
909.092	Microscope head	
909.093	Microscope head with camera connection	
909.406 ²	LCD microscope head	
334.695	Mini AC adapter 12 Vdc, 1 A	

¹ To be used with stand 909.405 for a larger Z axis range.

² Adapter 334.695 required.

Endoscopes

Endoscopes for inspecting hard-to-reach places by means of a flexible cable. Equipped with built-in illumination.

With the industrial endoscope images can be watched on the integrated LCD color display. When a Micro SD card is installed photos and videos can be made and saved.

The WiFi endoscope is connected with an Apple or Android telephone for displaying and storage of photos and videos. The needed software can be downloaded at no additional cost.

- Bendable cable \varnothing 5 mm, camera: \varnothing 5.5 mm.
- Cable length: 1 m.
- Camera resolution: 0.3 Mpx.
- Cable IP67.
- Field of view: 60°.
- Illumination: 6 LEDs, intensity adjustable.
- Flashlight in the handle.
- Power supply: 4 batteries type AA.

Industrial endoscope

- Focus distance: 6-8 cm.
- 3.5" LCD color display 320x240 px.
- 4x digital zoom.
- Rotatable image.
- Detachable display.
- Delivery with 45° mirror, magnet and hook (excl. Micro SD card).

WiFi endoscope

- Focus distance: 6-10 cm.
- USB cable included for wired connection with PC.
- Delivery with 45° mirror, magnet, hook and carrying case (excl. Micro SD card).



910.170

TECHNOBEARING

NEW



Item No.	Camera \varnothing /mm	Cable \varnothing /mm	Cable length/m	Price RUB
Industrial endoscope:				
910.170	5.5	5	1	
WiFi endoscope:				
910.171	5.5	5	1	
Options:				
910.172*	Cable length 1 m (for 910.170)			
910.173	Cable length 3 m (for 910.170)			
910.174*	Cable length 1 m (for 910.171)			
910.175	Cable length 3 m (for 910.171)			
910.176*	Mirror, magnet and hook			
495.111	Spare battery (4 needed)			

* Standard included.



910.171

013.319 Technobearing 201 (9625)

**Graduated rulers / Scale units / Circumference tapes
Precision tapes / Distance meters**



Accuracy of graduated rulers according DIN 2004/22

Measuring range (mm)	Max. permissible errors (±mm)	
	EC I	EC II
0 - 500	0.15	0.40
0 - 1000	0.20	0.50
0 - 1500	0.25	0.60
0 - 2000	0.30	0.70
0 - 3000	0.40	0.90
0 - 4000	0.50	1.10



Accuracy of graduated rulers according DIN 866 form A/B

Measuring range (mm)	Max. permissible errors (±mm)	
	form A	form B
0 - 500	0.04	0.10
0 - 1000	0.04	0.10
0 - 1500	0.06	0.15
0 - 2000	0.06	0.15
0 - 3000	0.08	0.20
0 - 4000	0.10	0.25
0 - 5000	0.12	0.30

D14_010 Technobearing 201 (RE23)

Rulers

- Measuring range: 0-3000 mm.
- Graduation: 1 mm.
- Material: bright steel or stainless steel.
- No graduation on first 5 mm at both ends.
- Accuracy and construction according DIN 866 form A.



Dimensions <i>l x w x t</i> /mm	Bright steel		Stainless steel		Wooden case	
	Item No.	Price RUB	Item No.	Price RUB	Item No.	Price RUB
500 x 30 x 6	776.280		776.371		776.568	
1000 x 40 x 8	776.281		776.366		776.468	
1500 x 40 x 8	776.282		776.289		776.561	
2000 x 50 x 10	776.283		776.399		776.562	
3000 x 50 x 10			776.369			

Rulers

- Measuring range: 0-4000 mm.
- Graduation: 1 mm.
- Material: bright steel or stainless steel.
- Zero coincides with left end.
- Accuracy and construction according DIN 866 form B.



Dimensions <i>l x w x t</i> /mm	Bright steel		Stainless steel		Wooden case	
	Item No.	Price RUB	Item No.	Price RUB	Item No.	Price RUB
500 x 25 x 5	776.270		776.276		776.568	
1000 x 30 x 6	776.271		776.277		776.468	
1500 x 30 x 6	776.272		776.360		776.561	
2000 x 40 x 8	776.273		776.373		776.562	
3000 x 40 x 8	776.274		776.357			
4000 x 50 x 10			776.410			

Rulers

Rulers with beveled edge for parallax-free reading.

- Measuring range: 0-2000 mm.
- Graduation: 1 mm.
- Accuracy according DIN 866 form B.
- Bright steel or stainless steel.
- Zero coincides with left end.



Dimensions <i>l x w x t</i> /mm	Bright steel		Stainless steel		Wooden case	
	Item No.	Price RUB	Item No.	Price RUB	Item No.	Price RUB
500 x 30 x 6	776.416		776.250		776.568	
1000 x 40 x 8	776.417		776.251		776.468	
1500 x 40 x 8	776.398		776.252		776.561	
2000 x 50 x 10	776.418				776.562	

Rulers

Rulers with beveled edge for parallax-free reading.

- Measuring range: 0-2000 mm.
- Graduation: 1 mm.
- Material: bright steel.
- Zero coincides with left end.

NEW



910.217



Item No.	Dimensions / x w x t/mm	Price RUB
910.216	300x40x5	
910.217	500x40x5	
910.218	1000x40x5	
910.219	1500x40x5	
910.220	2000x50x5	



Aluminum rulers

- Anodized.
- With mm graduation.



775.590



775.600

TECHNOBEARING

Item No.	Dimensions / x w x t/mm	Price RUB
775.590	300x35x1.5	
775.592	600x35x1.5	
775.593	1000x35x1.5	
With handle and magnet:		
775.600	450x50x3	
775.602	1000x50x3	

Stainless steel rulers

- Measuring range: 0-3000 mm.
- Graduation: 1 mm.
- No-glare finished stainless steel surface.
- With mm graduation on the upper edge.
- With 0.5 mm graduation on the lower edge.

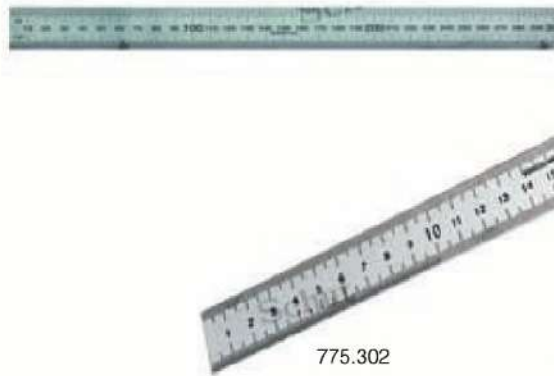

Item No.	Dimensions l x w x t/mm	Price RUB
With mm/0.5 mm graduation:		
775.300	150 x 15 x 0.5	
775.301	300 x 25 x 1	
775.583	600 x 29 x 1.2	
775.584	1000 x 35 x 1.2	
775.585	1500 x 40 x 2	
775.586	2000 x 40 x 2	
With mm/mm graduation:		
The first 100 mm on the lower edge have a 0.5 mm graduation.		
775.302	600 x 30 x 1.2	
775.303	1000 x 35 x 1.5	
775.304	2000 x 41 x 2	
775.305	3000 x 39 x 3	

Self-adhesive rulers

- Measuring range: 0-400 mm.
- Graduation: 1 mm, vernier: 0.1 mm.
- Blue anodized aluminum.
- With self-adhesive back.
- Suitable for positioning on measuring devices and machine elements.

Vernier 0.1 mm

- 10 scale divisions on 9 mm.
- Non-adhesive, furnished with two fixing holes $\varnothing 2.5$ mm.



Item No.	Measuring range/mm	Dimensions l x w x t/mm	Price RUB
775.901	0-200	208 x 16 x 0.5	
775.902	0-300	308 x 16 x 0.5	
775.903	0-400	408 x 16 x 0.5	
775.900	Vernier 0.1 mm	40 x 10 x 0.5	

TECHNOBEARING

Stainless steel rulers with L → R or R → L numbering

- Measuring range: 0-12000 mm.
- Graduation: 1 mm (type B: 0.5 mm).
- No-glare finished stainless steel surface.
- EC class II.
- Etched graduation.
- The rulers up to 4000 mm are conform EC class II.

Available on request:

- with graduation from top to bottom or from bottom to top,
- with different combinations (mm/mm, mm/inch, mm/blanc, etc.),
- with 0-point in the middle.
- Thickness: from 300 mm: 1 mm, from 500 mm: 2 mm.



Item No.	Price RUB	Item No.	Price RUB	Item No.	Price RUB	Item No.	Price RUB	Dimensions l x w x t/mm
L → R type A:		R → L type A:		L → R type B:		R → L type B:		
835.120		835.121		835.421		835.422		150 x 13 x 0.5
835.122		835.123		835.298		835.440		200 x 13 x 0.5
835.124		835.125		835.427		835.441		250 x 13 x 0.5
835.126		835.127		835.129		835.442		300 x 13 x 0.5
835.130		835.131		835.354		835.443		500 x 18 x 0.5
835.132		835.133		835.252		835.444		1000 x 18 x 0.5
835.134		835.135		835.428		835.445		1500 x 18 x 0.5
835.136		835.137		835.429		835.446		2000 x 18 x 0.5
835.138		835.139		835.430		835.447		2500 x 18 x 0.5
835.140		835.141		835.431		835.448		3000 x 18 x 0.5
835.142		835.143		835.432		835.449		3500 x 18 x 0.5
835.144		835.145		835.433		835.450		4000 x 18 x 0.5
835.146		835.147		835.413		835.451		5000 x 18 x 0.5
835.148		835.149		835.434		835.452		6000 x 18 x 0.5
835.150		835.151		835.035		835.453		7000 x 30 x 1
835.152		835.153		835.435		835.454		8000 x 30 x 1
835.154		835.155		835.436		835.455		9000 x 30 x 1
835.156		835.157		835.437		835.456		10000 x 30 x 1
835.158		835.159		835.438		835.457		11000 x 30 x 1
835.160		835.161		835.439		835.458		12000 x 30 x 1



Type A: mm/mm (bottom and top side 1 mm graduation).

Type B: 0.5 mm/1 mm (top side 0.5 mm, bottom side 1 mm graduation).

Rulers with a self-adhesive back

Item No.	Additional costs	Price RUB
835.165	For rulers up to 1000 mm (price per piece) For rulers from 1000 mm (price per meter)	

The self-adhesive back is *not* separately available.

TECHNOBEARING

With 0-point in the middle

Item No.	Dimensions l x w x t/mm	Price RUB
835.266	200 x 13 x 0.5	

Other sizes are also available.

014_305 Technobearing 201 (9623)

Rulers

Stainless steel rulers with laser engraving

- With mm/mm graduation from left to right.
- Graduation: 1 mm.
- With identification number.
- EC class I.

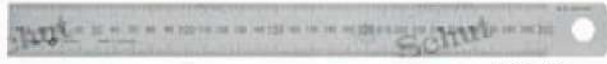

835.462

Stainless steel rulers with magnet inserts

- Graduation from left to right.
- Laser engraving.
- With 2 flat edges without hanger hole.
- Graduation on front and back side.
- Graduation: front side: 1 mm, 0.5 mm, back side: 1/32", 1/64".
- With removeable magnet inserts.
- EC class II.



835.473

Rulers (black) with laser engraving

- Graduation on front and back side.
- Graduation: front side: 1 mm, 0.5 mm, back side: 1/10", 1/16", 1/20", 1/32", 1/64", 1/50", 1/100".
- EC class II.



835.466

Stainless steel rulers with 90° anvil hook

- Graduation from left to right.
- Etched graduation.
- Graduation: front side: 1 mm, back side: 0.5 mm.
- EC class II.



835.476

TECHNOBEARING

Item No.	Dimensions l x w x t/mm	Material	Class	Price RUB
Stainless steel rulers with laser engraving:				
835.096	150 x 13 x 0.5	No-glare finished stainless steel surface	EC class I	
835.459	300 x 13 x 0.5	No-glare finished stainless steel surface	EC class I	
835.460	500 x 20 x 0.5	No-glare finished stainless steel surface	EC class I	
835.461	1000 x 20 x 0.5	No-glare finished stainless steel surface	EC class I	
835.462	300 x 30 x 1.0	No-glare finished stainless steel surface	EC class I	
835.463	500 x 30 x 1.0	No-glare finished stainless steel surface	EC class I	
835.464	1000 x 30 x 1.0	No-glare finished stainless steel surface	EC class I	
835.465	2000 x 30 x 1.0	No-glare finished stainless steel surface	EC class I	
Rulers (black) with laser engraving:				
835.466	150 x 18 x 0.5	Steel, black surface	EC class II	
835.467	300 x 30 x 1.0	Steel, black surface	EC class II	
835.468	450 x 30 x 1.0	Steel, black surface	EC class II	
835.469	600 x 30 x 1.0	Steel, black surface	EC class II	
835.470	1000 x 30 x 1.0	Steel, black surface	EC class II	
Stainless steel rulers with magnet inserts:				
835.471	150 x 20 x 1.0	No-glare finished stainless steel surface	EC class II	
835.472	300 x 30 x 1.0	No-glare finished stainless steel surface	EC class II	
835.473	600 x 30 x 1.0	No-glare finished stainless steel surface	EC class II	
835.474	900 x 30 x 1.0	No-glare finished stainless steel surface	EC class II	
835.475	1200 x 30 x 1.0	No-glare finished stainless steel surface	EC class II	
Stainless steel rulers with 90° anvil hook:				
835.476	200 x 13 x 0.5	No-glare finished stainless steel surface	EC class II	
835.477	300 x 13 x 0.5	No-glare finished stainless steel surface	EC class II	
835.478	500 x 18 x 0.5	No-glare finished stainless steel surface	EC class II	

014_036 Technobearing 2019 0625

Digital horizontal scale units

These scale units are available in two different models. Up to 300 mm the model matches the photo of the 906.403, from 450 mm the photo of the 906.406.

- Measuring range: 0- 1000 mm.
- Resolution: 0.01 mm.
- Repeatability: 0.01 mm.
- mm/inch conversion.
- ABS/INC switchable (from 450 mm).
- On/off switch.
- Reset.
- Preset (from 450 mm).
- Max. measuring speed:
 < 500 mm: 1.5 m/s,
 ≥ 500 mm: 1 m/s.
- Power supply:
 906.400 -403: 1 battery type V357,
 906.404 -409: 1 battery type CR2032.

Item No.	Measuring range/mm	Accuracy mm	Price RUB
906.400	0 - 100	±0.03	
906.401	0 - 150	±0.03	
906.402	0 - 200	±0.03	
906.403	0 - 300	±0.04	
906.404	0 - 450	±0.05	
906.405	0 - 500	±0.05	
906.406	0 - 600	±0.05	
906.408	0 - 800	±0.06	
906.409	0 - 1000	±0.07	

Options:

- 836.535 Spare battery type V357
- 495.157 Spare battery type CR2032



Digital vertical scale units

- Measuring range: 0- 1000 mm.
- Resolution: 0.01 mm.
- Repeatability: 0.01 mm.
- mm/inch conversion.
- ABS/INC switchable.
- On/off switch.
- Reset.
- Preset (from 500 mm).
- Max. measuring speed: 1 m/s.
- Power supply:
 1 battery type V357
 (except 906.416-419).

Item No.	Measuring range/mm	Accuracy mm	Price RUB
906.415	0 - 100	±0.03	
906.416	0 - 150	±0.03	
906.417	0 - 200	±0.03	
906.418	0 - 300	±0.04	
906.419	0 - 450	±0.05	
906.420	0 - 500	±0.05	
906.421	0 - 600	±0.05	
906.423	0 - 800	±0.06	
906.424	0 - 1000	±0.07	

Options:

- 836.535 Spare battery type V357
- 495.157 Spare battery type CR2032

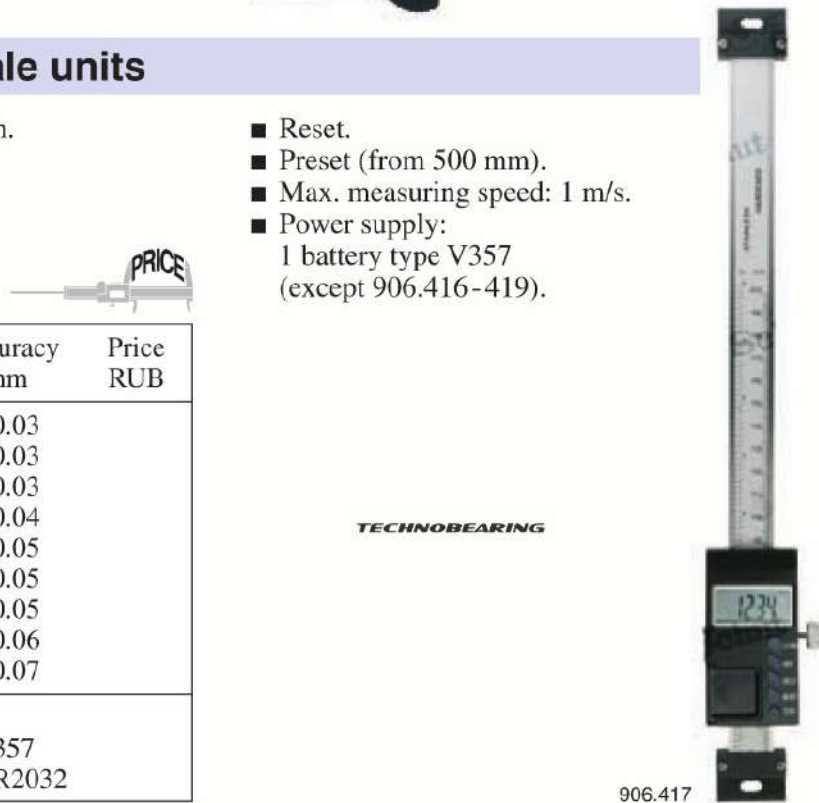

Circumference tapes

- Separate graduations for circumference and diameter in mm.
- Vernier: 0.1 mm.
- Bright steel or stainless steel.
- Accuracy according EC class II.
- With measuring report on request.

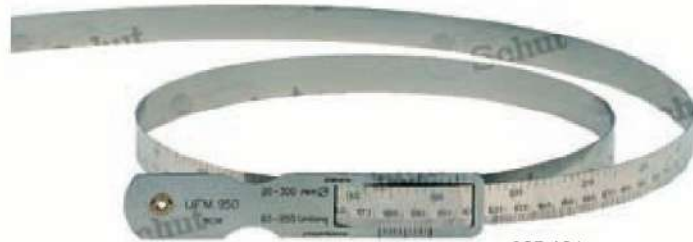

835.101

TECHNOBEARING

Bright steel

Item No.	Diameter mm	Circumference mm	Price RUB
835.111	20- 300	60- 950	
835.112	300- 700	940- 2200	
835.113	700-1100	2190- 3460	
835.114	1100-1500	3450- 4720	
835.115	1500-1900	4710- 5980	
835.116	1900-2300	5960- 7230	
835.117	2300-2700	7220- 8500	
835.118	2700-3100	8480- 9760	
835.119	3100-3500	9730-11010	

Stainless steel

Item No.	Diameter mm	Circumference mm	Price RUB
835.101	20- 300	60- 950	
835.102	300- 700	940- 2200	
835.103	700-1100	2190- 3460	
835.104	1100-1500	3450- 4720	
835.105	1500-1900	4710- 5980	
835.106	1900-2300	5960- 7230	
835.107	2300-2700	7220- 8500	
835.108	2700-3100	8480- 9760	
835.109	3100-3500	9730-11010	

Circumference tapes for diameters

Circumference tapes for measuring of diameters.

- Graduation in mm.
- Vernier: 0.02 mm.
- Total tape width: 13 mm.
- Bright steel.
- Accuracy according DIN 866/B.

NEW



910.181

Item No.	Diameter mm	Price RUB
910.181	15- 50	
910.182	50- 300	
910.183	300- 600	
910.184	600- 900	
910.185	900-1200	
910.186	1200-1500	
910.187	1500-1800	
910.188	1800-2100	
910.189	2100-2400	
910.190	2400-2700	
910.191	2700-3000	



910.181

014.2015 Technobearing 201 (94628)

Laser distance meters

With these compact hand laser distance meters you aim a visual laser spot at the object for quick and accurate measurements of the distance without contact.

- Measuring range: 0-80 m.
- Resolution: 0.001 m/0.01 m.
- Accuracy: ± 2 mm.
- Distance, surface and volume measurements, continuous measurements, addition and subtraction, min/max function and Pythagoras function.
- mm/inch/ft conversion.
- Illuminated LCD display.
- On/off switch, automatic switch-off.
- Measurement reference: front or rear.
- Storage for 99 measuring values.
- With thread for tripod.
- Laser: 635 nm, class II according IEC 60825-1.
- Dimensions: 120 x 55 x 30 mm.
- Weight: 909.453: 180 g, 909.454: 128 g.
- Power supply: 2 batteries type AAA.



Item No.	Measuring range/m	Price RUB
909.453	0-40	
909.454	0-80	
Option:		
497.914	Spare battery	

TECHNOBEARING

909.454



Precision tapes

Cost effective rubberized precision tapes.

- Yellow varnished steel strip with mm graduation.
- One-sided printed blade.
- Matt finished steel blade.
- EC class II.
- Standard EC-type hook.



910.057

910.060



Item No.	Length m	Tape width mm	Price RUB
910.056	2	16	
910.057	3	16	
910.058	5	19	
910.059	8	25	
910.060	10	25	

014.304. Technobearing 201 (9628)

Precision tapes

Precision tapes for professional use with double-sided printed blade and double hook with magnet.

- EC class II (except 910.064).
- EC class I (only 910.064).

- Shockproof til 2 m.
- Matt finished steel blade.
- Double-sided printed blade (except 910.064).
- Blade horizontal stand-out:
19 mm: 1.7 m, 27 mm: 2.8 m.
- EC-type magnet dual hook (except 910.064).
- Double lock (except 910.064).
- Delivery with a EC class I declaration of conformity (only 910.064).



910.062



910.062



Item No.	Length m	Tape width mm	Price RUB
910.061	3	19	
910.062	5	27	
910.063	10	27	
EC class I:			
910.064	3	19	

Long stroke precision tape

Long stroke precision tape with blade from fiberglass and with high speed retracting gear.



- Double-sided printed blade.
- Graduation: 2 mm.
- EC class II.



Item No.	Length m	Tape width mm	Price RUB
910.065	30	15	

Long stroke precision tapes

- Black plastic housing with wristlet.

- White varnished steel strip with mm graduation.
- Winding-on handle.
- EC class II.



775.543

Item No.	Length m	Tape width mm	Price RUB
775.540	10	9.5	
775.541	15	9.5	
775.542	20	9.5	
775.543	30	9.5	

014.209. Technobearing 201 (9628)

Digital measuring tape

Digital measuring tape equipped with a 19 mm wide tape, which is provided with a clear graduation. The digital indication is convertible from external to internal measurements and can be reset to zero at any point on the tape.

- Measuring range: 0-5 m.
- Resolution: 1 mm.
- Accuracy: $\pm(0.3+0.2L)$ mm (L in m).
- mm/inch conversion.
- Hold function.
- Reversal of display value.
- Automatic stop.
- Convertible for internal/external measurements.
- Storage for 8 measuring values.
- Dimensions: 75 x 70 mm.
- Power supply: 1 battery type CR2032.



Item No.	Length m	Tape width mm	Price RUB
909.341	5	19	
Option: 495.157 Spare battery			

Digital measuring wheel

With this measuring wheel long distance measurements can be done quickly and easily.

- Measuring range: 0-10000 m.
- Resolution: 0.1 m.
- Accuracy: <0.5%.
- m/ft conversion.
- Wheel size: \varnothing 160 mm.
- Display located near handle.
- Adjustable in height.
- Reset.
- Storage for 5 values.
- Weight: 0.8 kg.
- Delivery incl. pouch.
- Power supply: 2 batteries type AAA.
- Measuring range: 103.5-500 cm.
- With mm graduation.
- Aluminum model with steel measuring faces.
- With circular spirit level (for vertical use) and horizontal spirit level.
- Delivery in a case.



Item No.	Description	Price RUB
909.518	Digital measuring wheel	
Option: 497.914 Spare battery (2 needed)		

Telescopic scale



TECHNOBEARING



Item No.	Description	Price RUB
909.519	Telescopic scale	

Scribing tools / Compasses / Center squares



D15.D00.
Technobearing 201 (96628)

Marking gauges

- Measuring range: 0-400 mm.
- Vernier: 0.1 mm.
- No-glare chrome finished beam.
- Roll stop.



Item No.	Measuring range/mm	Price RUB
836.602	0 - 200	
836.604	0 - 400	
836.603	Spare scriber point	

TECHNOBEARING

Marking gauges

- Measuring range: 0 - 500 mm.
- Vernier: 0.1 mm.
- With round rod and mm graduation.



Item No.	Measuring range/mm	Price RUB
Without fine adjustment:		
907.183	0 - 200	
907.184	0 - 300	
907.185	0 - 400	
907.186	0 - 500	
With fine adjustment:		
907.187	0 - 200	
907.188	0 - 300	
907.189	0 - 400	
907.190	0 - 500	
907.191	Spare scriber point (TC)	



015.201. Technobearing 201 (RUB25)

Marking calipers

T-shaped stainless steel marking caliper with a large marking face/cross scale. The marking face is sunk into the U-shaped base face.

- Measuring range: 0-300 mm.
- Locking screw.
- Vernier: 0.05 mm.
- With or without fine adjustment.
- No-glare chrome finished beam.
- Marking face/cross scale with mm graduation (50-0-50 mm).

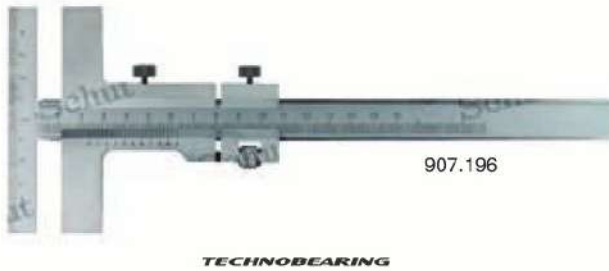

Item No.	Measuring range/mm	Base length/mm	Price RUB
Without fine adjustment:			
907.575	0-160	140	
907.576	0-250	140	
907.577	0-300	160	
With fine adjustment:			
907.196	0-160	140	
907.197	0-250	140	
907.198	0-300	160	

Marking gauges

- Measuring range: 0-300 mm.
- Vernier: 0.1 mm.
- No-glare chrome finished beam.



Item No.	Measuring range/mm	Price RUB
907.180	0-200	
907.181	0-250	
907.182	0-300	

Digital marking gauge and protractor

- Measuring range: 0-300 mm.
- Resolution: protractor: 0.05°, scale: 0.01 mm.
- mm/inch conversion.
- On/off switch.
- Automatic switch-off.
- Reset.
- Hold function.
- Locking screw.
- Protection: IP40.
- Power supply: 1 battery type CR2032.



Item No.	Measuring range/mm	Price RUB
906.669	0-300	
Option:		
495.157	Spare battery	

NEW

Scriber



TECHNOBEARING



Item No.	Description	Price RUB
909.388	Scriber with clip, with tungsten carbide exchangeable point and magnetic upper part	
Replacement point:		
909.389	1 tungsten carbide scriber point for 909.388	

Trammels

- Round rod with graduation.
 - Milled key groove.
 - Vernier: 0.1 mm.
 - Fine adjustment.
- (Also available without fine adjustment.)



Item No.	Length/mm	Price RUB
671.275	500	
671.276	1000	
671.277	1500	
671.278	2000	
Needles per pair:		
671.234	Hardened steel	
671.239	Tungsten carbide	

Trammels

- Flat beam with graduation.
- Vernier: 0.1 mm.
- Fine adjustment.



Item No.	Length/mm	Price RUB
671.261	500	
671.262	1000	
671.263	1500	
671.264	2000	
Needles per pair:		
671.230	Hardened steel	
671.235	Tungsten carbide	

015.204 Technobearing 201 (RUB)

Spring joint dividers

- Stainless steel construction.
- With adjustment screw.
- With interchangeable points (910.012-018, 907.447-448).
- With pencil holder (907.447-448).



Item No.	Description	Price RUB
907.446	Spare divider point $\varnothing 2 \times 30$ mm	

Length/mm	Item No.	Price RUB	Item No.	Price RUB	Item No.	Price RUB
100	-		910.012		-	
125	-		910.013		-	
150	907.827		910.014		907.447	
175	-		910.015		-	
200	907.828		910.016		907.448	
250	907.829		910.017		-	
300	907.830		910.018		-	
400	907.831		-		-	
500	907.832		-		-	
600	907.833		-		-	

Firm joint compasses

- Stainless steel construction.
- With adjustment arch and locking screw (907.818-826, 909.461-469).
- With pencil holder (909.461-469).



TECHNOBEARING



Length/mm	Item No.	Price RUB	Item No.	Price RUB	Item No.	Price RUB
150	907.809		907.818		909.461	
200	907.810		907.819		909.462	
250	907.811		907.820		909.463	
300	907.812		907.821		909.464	
400	907.813		907.822		909.465	
500	907.814		907.823		909.466	
600	907.815		907.824		909.467	
800	907.816		907.825		909.468	
1000	907.817		907.826		909.469	

Internal spring joint compasses

- Stainless steel construction.
- With adjustment screw.



TECHNOBEARING



Item No.	Length/mm	Price RUB
907.793	100	
907.794	125	
907.795	150	
907.796	200	
907.797	250	
907.798	300	
907.799	400	
907.800	500	

External spring joint compasses

- Stainless steel construction.
- With adjustment screw.



Item No.	Length/mm	Price RUB
907.801	100	
907.802	125	
907.803	150	
907.804	200	
907.805	250	
907.806	300	
907.807	400	
907.808	500	

Firm joint compasses

- Stainless steel construction.



Item No.	Length/mm	Price RUB
907.836	100	
907.837	125	
907.838	150	
907.839	200	
907.840	250	
907.841	300	
907.842	400	
907.843	500	
907.844	600	
907.845	800	
907.846	1000	

Firm joint compasses

- Stainless steel construction.



Item No.	Length/mm	Price RUB
907.847	100	
907.848	125	
907.849	150	
907.850	200	
907.851	250	
907.852	300	
907.853	400	
907.854	500	
907.855	600	
907.856	800	
907.857	1000	

015.3D1. Technobearing 201 (9628)

Center squares

Center squares with mm graduation on the blade, to mark the center on round discs or axes.

- Stainless steel construction, no-glare chrome finished.
- Graduation placed by laser.

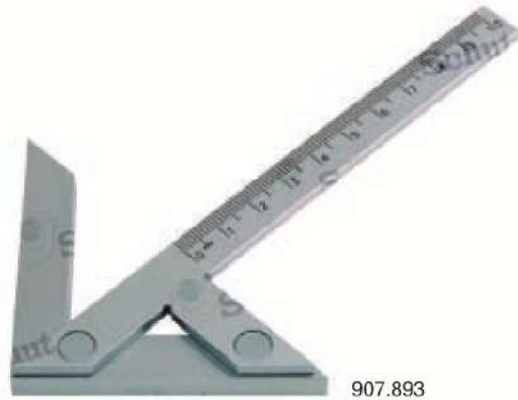

Item No.	Length/mm		Max. ϕ mm	Price RUB
	l_1	l_2		
907.893	100	70	90	
907.894	150	130	190	
907.895	200	150	220	
907.896	250	160	230	
907.897	300	180	280	
909.972	400	250	380	
909.973	500	330	530	

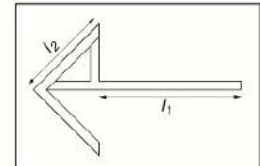

Caliper compasses

- For scribing of diameters of 0 - 600 mm.
- Vernier: 0.1 mm.
- Stainless steel construction, no-glare chrome finished.
- Fixed jaw and beam made out of one piece.
- Hardened, ground and lapped measuring faces.



Item No.	For scri- bing up to ϕ /mm	Meas. range mm	Jaw length mm	Price RUB
909.424	300	150	40	
909.425	400	200	40	
909.426	500	250	40	
909.427	600	300	40	

TECHNOBEARING

Universal setting instrument

This multilateral instrument is specially designed for manufacturers of very accurate products, such as gauges and toolmakers. The guide is installed under an angle of 20° and the components can be moved very accurately. The movable component has several threaded bores M4, by which the setting instrument also can be used as a scriber or height gauge.

- Max. height range incl. extensions: 270 mm.
- Dimensions: 133 x 64 x 18.5 mm.
- Delivery with extensions 25 mm and 75 mm (equipped with thread M4/thread hole M4).
- Base with vial.



Item No.	Description	Price RUB
906.455	Universal setting instrument	



Surface gauge

Stable foot with V-slot at the ground surface, grips at the side and is also equipped with two bores (ø 5.5 mm).

- Foot ground all around (except for the V-slot).
- Fine adjustment.
- Dimensions:
 scriber: ø 4 x 200 mm,
 arm: ø 10 x 300 mm, ø 10 x 450 mm,
 foot: 85 x 65 x 25 mm.

TECHNOBEARING



Item No.	Description	Price RUB
906.220	Surface gauge	



019.201. Technobearing 201 (9623)

Height and scribing gauges / Height gauges



D16.D10.
Technobearing 201 (REG28)

Digital height and scribing gauges

- Measuring range: 0-1000 mm.
- Resolution: 0.01 mm.
- mm/inch conversion.
- ABS/INC switchable.
- On/off switch.
- Reset.
- Hold function.
- Fine adjustment.

- Delivery incl. scriber.
- Power supply:
909.244/245/246: 1 battery type V357,
906.267/268: 1 battery type CR2032.

From measuring range 500 mm:

- Tolerance function.
- Preset.



TECHNOBEARING



Item No.	Measuring range/mm	Accuracy mm	Price RUB
906.267	0- 200	±0.03	
906.268	0- 300	±0.04	
909.244	0- 500	±0.05	
909.245	0- 600	±0.07	
909.246	0-1000	±0.07	

Options:

- 836.535 Spare battery type V357
- 495.157 Spare battery type CR2032
- 906.029 Scriber for 906.267
- 906.049 Scriber for 906.268
- 906.054 Scriber for 909.244
- 906.075 Scriber for 909.245
- 906.077 Scriber for 909.246

D19.202 Technobearing 201 (9623)

Absolute digital height and scribing gauges

Digital height and scribing gauges with an absolute measuring system.

- Measuring range: 0-600 mm.
- Resolution: 0.01 mm.
- Handwheel drive for easy head displacement.
- Interchangeable scriber, intake 9x9 mm.
- ABS/INC switchable.
- Digimatic data output.
- On/off switch.
- Reset.
- Hold function.
- Locking screw.
- Delivery incl. scriber, dial indicator holder and Digimatic data cable.
- Power supply: 1 battery type CR2032.

USB interface:

- For data transfer to PC (e.g. Excel, Word).
- Operating system: Windows and other.
- PC connection: USB.
- No software or driver to install.
- Foot switch (optional).



910.096

TECHNOBEARING



910.096



909.686



909.687



910.039/038



Item No.	Measuring range/mm	Accuracy mm	Price RUB
910.096	0-300	0.03	
910.097	0-600	0.05	
With Bluetooth:			
910.098	0-300	0.03	
Options:			
495.157	Spare battery		
909.686	USB interface		
909.687	Footswitch for USB interface		
910.038	Wireless USB receiver		
910.039	Wireless transmitter		
906.256	Scriber		

019.315 Technobearing 201 (9625)

Special digital height and scribing gauges

The dual display model shows the measuring value on the displays on both sides of the instrument, ideal for left handed use. The magnetic base model is made primarily of plastic, which makes it very light and easy to handle. Due to the magnets in the flat plastic base the instrument can also be placed on magnetic surfaces at an angle.

- Measuring range: 0- 150 mm.
- Resolution: 0.01 mm.
- mm/inch conversion.
- On/off switch.
- Delivery incl. scriber.
- Double display (906.225).
- Magnetic base (906.226).
- Power supply:
906.225: 1 battery type V357,
906.226: 1 battery type CR2032.



Item No.	Accuracy/mm	Price RUB
906.225	±0.03	
906.226	±0.4	
Options:		
836.535	Spare battery type V357	
495.157	Spare battery type CR2032	
906.344	Scriber for 906.225	
906.354	Scriber for 906.226	



Digital height and scribing gauge with dial indicator holder

Solid and stable instrument with integrated dial indicator holder and stainless measuring table.

- Measuring range: 0- 500 mm.
- Resolution: 0.01 mm.
- mm/inch conversion.
- ABS/INC switchable.
- On/off switch.
- Preset.
- Reset.
- Hold function.
- Tolerance function.
- Fine adjustment.
- Intake scriber: 8 x 6 mm.
- Delivery incl. scriber.
- Dial gauge clamping shaft 8 mm.
- Measuring table: 906.115/116: 80 x 80 mm,
906.117: 110 x 100 mm.
- Power supply: 1 battery type V357.

TECHNOBEARING



Item No.	Measuring range/mm	Accuracy mm	Price RUB
906.115	0- 200	±0.04	
906.116	0- 300	±0.04	
906.117	0- 500	±0.06	
Options:			
836.535	Spare battery		
906.343	Scriber		



019.014. Technobearing 201 (9623)

Digital double columns height and scribing gauges

This is a very stable digital height gauge because of its twin guide system. The measuring unit moves over two independent columns with high precision toothed racks, which generates an accurate measurement.

- Measuring range: 0-600 mm.
- Resolution: 0.01 mm.
- Repeatability: 0.01 mm.
- Handwheel drive for easy head displacement.
- mm/inch conversion.
- ABS/INC switchable.
- On/off switch.
- Reset/preset.
- Intake scriber: 9 x 9 mm.
- Delivery incl. scriber.
- Power supply: 1 battery type V357.

TECHNOBEARING



906.263



Item No.	Measuring range/mm	Accuracy mm	Price RUB
906.263	0-300	±0.04	
906.264	0-500	±0.05	
906.265	0-600	±0.05	
Option:			
836.535	Spare battery		
906.118	Scriber 9x9 mm		

Height and scribing gauges with dial and counter

- Measuring range: 0-1000 mm.
- Graduation dial indicator: 0.01 mm.
- Resolution counter: 1 mm.
- 1 pointer revolution = 1 mm.
- Rotatable dial.
- Double counter, one indicator in plus direction and one in minus direction.
- Zero setting possible at any height.
- Intake scriber: 9 x 9 mm.
- Delivery incl. scriber.



Item No.	Measuring range/mm	Accuracy mm	Price RUB
906.250	0- 300	±0.04	
906.251	0- 450	±0.05	
906.252	0- 600	±0.05	
906.253	0- 800	±0.06	
906.254	0-1000	±0.07	
Option:			
906.174	Scriber 9x9 mm		



Height and scribing gauges with dial

These height gauges are equipped with a rack, as used for dial calipers.

- Measuring range: 0-300 mm.
- Graduation: 0.02 mm.
- 1 pointer revolution = 2 mm.
- Rotatable dial.
- Fine adjustment.
- Delivery in a case with a scriber.

TECHNOBEARING



Item No.	Measuring range/mm	Accuracy mm	Price RUB
906.260	0- 150	±0.03	
906.261	0-200	±0.03	
906.262	0-300	±0.04	



019.204. Technobearing 201 (9623)

Height and scribing gauges

- Measuring range: 0-1000 mm.
- Vernier: 0.02 mm.
- Fine adjustment.
- Delivery incl. scriber.
From 500 mm with fixed scriber.
- No-glare chrome finished scale and vernier.



Item No.	Measuring range/mm	Accuracy mm	Price RUB
906.325	0- 200	±0.03	
906.326	0- 300	±0.04	
906.327	0- 500	±0.05	
906.328	0-1000	±0.07	
Options:			
906.324	Scriber for 906.325/326		
906.329	Scriber for 906.327/328		



Height and scribing gauges with magnifier

To minimize the possibility of reading errors these height gauges are equipped with a magnifier. The magnifier can be adjusted in height, so that it can always be positioned correctly with regard to the vernier.

- Measuring range: 0-500 mm.
- Vernier: 0.02 mm.
- Ruler adjustable in height.
- Fine adjustment.
- Intake scriber: 9 x 9 mm.
- Delivery incl. scriber.



Item No.	Measuring range/mm	Accuracy mm	Price RUB
906.255	0-300	±0.04	
906.257	0-500	±0.05	
Options:			
906.269	Scriber for 906.255		
906.323	Scriber for 906.257		



www.technobearing.ru

Hardness testers / Thickness gauges / Thermometers Tachometers / Dynamometers / Inspection instruments



D19.D00
Technobearing 201 (96)23

Portable Shore hardness testers

Portable hardness testers to measure Shore hardness A or D, according to DIN ISO 7619-1, ISO 868 and ASTM D 2240.

- Measuring range: 0-100 Shore.
- Analog: graduation 1 Shore, digital: resolution 0.1 Shore.
- Measuring length: 2.5 mm.
- Material thickness: ≥6 mm.
- Delivery in a case.

Analog

- Dial diameter: 57 mm.
- Dimensions: 110 x 58 x 30 mm.
- Weight: 230 g.

Digital

Integrated sensor and equipped with comfortable buttons. Possibility for display of current, average and maximum measuring value.

- Accuracy: ± 1 Shore.
- RS232C data output.
- On/off switch.
- Automatic switch-off.
- Max function.
- Calculation of the average of at most 9 measurements in "max mode".
- Dimensions: 161 x 65 x 28 mm.
- Power supply: 4 batteries type AAA.

TECHNOBEARING

909.066



Item No.	Type	Meas. range/Shore	Price RUB
Analog:			
907.882	Shore A	20- 90	
907.889	Shore D	20- 90	
Digital:			
909.066	Shore A	0-100	
909.068	Shore D	0-100	
Options:			
497.914	Spare battery (4 needed)		
909.078	RS232C cable and software		
909.430	Shore A (30 x 90) test block set 50 x 50 x 7 mm		
909.431	Shore D (30 x 90) test block set 50 x 50 x 7.5 mm		





907.882



909.430



909.431

Type	Shore A	Shore D
Max. spring force	8.065 N	44.50 N
Impact module	 35°	 30°
Applications	Soft rubber, elastomers, nature rubber, etc.	Hard rubber, thermoplastics, etc.

Portable hardness testers

For measuring the hardness of various materials like aluminum, copper, brass and soft steel. Fit for various forms like extrusion profiles, tubes and flat materials.

- Measuring range: 0-20 Webster.
Values to convert by means of graph (Rockwell B or E Scale).
- Material thickness: 0.4-6 mm.
- Round anvil: $\phi 3/8"$.
- Delivery in a case incl. spare penetrator, screwdriver, adjusting wrench, standard test strip and manual.

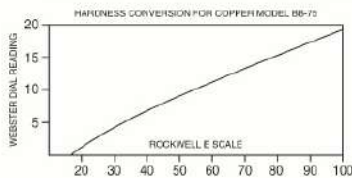
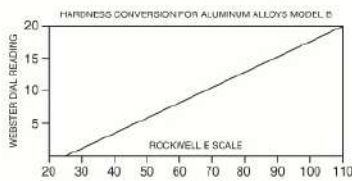
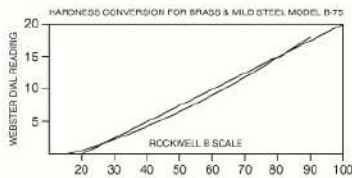

Item No.	Rockwell	Material	Price RUB
909.455	E25 - E110	aluminum	
909.456	B25 - B100	brass, hard	
909.457	E20 - E100	aluminum, soft steel copper	

Portable digital hardness tester

This Swiss made quality product allows one to determine HRC hardness in the most simple way. Modern technology resulted in an extremely compact and easy to use tool. No switches, buttons or cables, simply pull up the ring, measure and immediately read out the value. The measurement causes hardly any damage to the product. Especially suitable for larger objects, installed machines and use in hard-to-reach places.

- Measuring range: 20-70 HRC.
- Resolution: 0.1 HRC.
- Accuracy: ± 1.0 HRC.
- Automatic switch-off.
- Operating temperature: 5 to 50°C.
- Dimensions: $\phi 12 \times 140$ mm.
- Weight: 36 g.
- Power supply: 2 batteries type V394.

Requirements

- Solid base (at least 5 kg) for objects < 5 kg.
- Minimum thickness of objects: 3 mm.
- Minimum thickness of a hardened top layer, if any: 0.7 mm.
- Minimum diameter of workpiece: 10 mm.
- Minimum radius of spherical measuring surface: 30 mm.



Item No.	Description	Price RUB
774.075	Digital hardness tester	
Option:		
420.248	Spare battery (2 needed)	



TECHNOBEARING



018.002. Technobearing 201 (9625)

Portable digital hardness testers

- Measuring range:
HL 174 -900, HB 20 -655,
HRC 19.6- 68, HV80 -940,
HRB 13.5-101.7, HS 32.5- 99.5.
- Accuracy: ±0.5% (at HL 800).
- On/off switch, automatic switch-off.
- Min. radius: 30 mm.
- Tungsten carbide stylus tip.
- USB data output.
- ASTM A956.
- Delivery with an inspection report.

Digital hardness tester (909.470)

- Storage for 10000 measuring values.
- Operating temperature: -20 to 50°C.
- Dimensions basic instrument: 133 x 75 x 29 mm.
- Weight basic instrument: 260 g.

- Delivery in a case with software and cable, small supporting ring, test block D (909.478) and impact module D (909.471).
- Power supply: 2 batteries type AA.



909.470

NEW



909.470



Item No.	Description	Price RUB
909.470	Digital hardness tester	
909.485	Digital hardness tester	
Options:		
909.477	Set special support rings	
909.478 ¹	Testblock D, 2.5 kg (HLD 790 ±40)	
909.479 ^{1,2}	Testblock G, 5.5 kg (HLD 590 ±40)	
Options (only for 909.470):		
495.111	Spare battery (2 needed)	
909.480	Printer	
270.732	Printing paper (5 rolls)	
909.471	Ext. impact module D	
909.472	Ext. impact module G	
909.473	Ext. impact module C	
909.474	Ext. impact module DL	
909.481	Cable for ext. impact module	

¹ Delivery with an inspection report.

² For use in combination with impact module G.

Digital hardness tester (909.485)

- Storage for 1250 measuring values.
- With integrated impact module D.
- Operating temperature: -20 to 40°C.
- Dimensions basic instrument: 158 x 41 x 26 mm.
- Weight basic instrument: 120 g.
- Delivery in a case with AC adapter/charger, software and cable, small supporting ring, test block D (909.478) and integrated impact module D.
- Power supply: 1 rechargeable battery 3.7 V.
- AC adapter/charger.



909.485

TECHNOBEARING

Selection table materials for impact module D

Material	HLD	HRC	HRB	HB	HS	HV
bright steel	300-900	20.0-68.0	38.4- 99.5	80-647	32.5-99.5	80-940
tool steel	300-840	20.4-67.1				80-898
stainless steel	300-800	19.6-62.4	46.5-101.7	85-655		85-802
gray cast iron	360-650			93-334 (30D ²)		
cast iron	400-660			131-387 (30D ²)		
cast aluminum	174-560			20-159 (10D ²)		
brass	200-550		13.5-95.3	40-173 (10D ²)		
bronze	300-700			60-290 (10D ²)		
copper	200-690			45-315 (10D ²)		



909.480

018.319 Technobearing 201 (06/23)

Portable digital hardness testers (continued)

Optional impact devices

External impact module D

External module, instead of standard module.

External impact module DL

With thin, long probe on the impact module for measuring in grooves, blind bores etc.

External impact module C

4x reduced impact energy for hardened components, thin-walled materials and coatings.

External impact module G

9x higher impact energy for rough casting pieces etc.

Impact devices	D	DL	C	G
Max. roughness (Ra)	2	2	0.4	7
Impacting energy (Nmm)	11	11	3	90
Mass of impact body (g)	5.5	7.8	3.0	20
Impact body length (mm)	147	250	141	254
Max. hardness of workpiece (HV)	940	940	1000	-
Max. hardness of workpiece (HB)	-	-	-	650
Min. weight of sample: of compact shape (kg)	5	5	1.5	15
on solid support (kg)	2	2	0.5	5
coupled on plate (kg)	0.1	0.1	0.02	0.5
Min. thickness of sample: coupled (mm)	3	3	1	10
min. thickness of hardened layers (mm)	0.8	0.8	0.2	-



909.471



909.472



909.473



909.474

Impact bodies

Item No.	Description	Price RUB
909.482	Impact body D	
909.483	Impact body G	
909.564	Impact body C	
909.484	Impact body DL	

TECHNOBEARING

909.477



Set special support rings

The set consists of

Type	Description
①	Cylindrical outside surface R10 - R15
①	Cylindrical outside surface R14.5 - R30
①	Cylindrical outside surface R25 - R50
②	Cylindrical inside surface R11 - R13
②	Cylindrical inside surface R12.5 - R17
②	Cylindrical inside surface R16.5 - R30
③	Spherical outside surface SR10 - SR15
③	Spherical outside surface SR14.5 - SR30
③	Spherical outside surface SR11 - SR13
④	Spherical inside surface SR12.5 - SR17
④	Spherical inside surface SR16.5 - SR30
⑤	Cylindrical outside surface, radius adjustable $\geq R10$

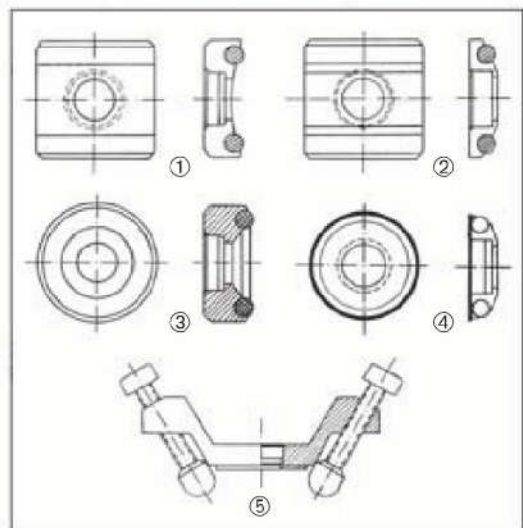

D18.320 Technobearing 2019 06/23

Portable digital hardness tester

With this portable hardness tester one can easily measure the hardness of installed machines or steel constructions, in hard-to-reach places, of heavy and large objects and for example for inspection of large series in the production process. The most common hardness scales can be measured and read out directly on the screen.

- Measuring range with impact module D:
HLD 200 - 900, HB 30 - 650,
HRC 20 - 68, HV 80 - 940,
HRB 20 - 100, HSD 32.5 - 99.5.
- Accuracy: $\pm 0.8\%$ (at HLD 800).
- On/off switch, automatic switch-off.
- Storage for 500 measuring values.
- Calculates automatically the average of at most 7 measuring values.
- Min. radius: 30 mm.
- Operating temperature: 0 to 45°C.
- Admissible relative humidity: <90%.
- Dimensions basic instrument: 170x68x30 mm.
- Weight basic instrument: 250 g.
- Delivery including:
 - integrated impact module D,
 - test block HLD 2.5 kg,
 - 2 batteries.
- ASTM A956.
- Delivery with an inspection report.
- Power supply: 2 batteries type AAA.

External impact module C

4x reduced impact energy for hardened components, thin-walled materials and layers on a surface.

External impact module DL

With thin, long probe on the impact module for measuring in grooves, blind bores etc.



Item No.	Description	Price RUB
906.804	Digital hardness tester	
Options:		
497.914	Spare battery (2 needed)	
906.813	Ext. impact module C	
906.817	Ext. impact module DL	
906.834 ⁴	Test block 2.5 kg (HLD 750 - 850)	

⁴ Delivery with an inspection report.

Requirements

Impact module	Min. weight workpiece/kg ₁	Min. thickness/mm object ₂	Min. thickness/mm hardened top layer ³	Max. roughness Ra/ μm
C	0.5	1.5	1	0.2
D/DL	2	5	5	0.8
G	5	15	10	6.3

¹ On a solid base of at least 5 kg.

² Without solid base.

³ Minimum thickness of a hardened top layer, if any.

Selection table materials for impact module D/DL

Material	HLD	HRC	HRB	HB (30D ²)	HSD	HV
bright steel	300-900	20.0-68.0	38.4-99.5	80-647	32.5-99.5	80-940
tool steel	300-840	20.4-67.1				80-898
stainless steel	300-800	19.6-62.4	46.5-101.7	85-655		85-802
gray cast iron	400-660			131-387		
cast iron	360-650			90-334		
cast aluminum	200-560			30-160 (10D ²)		
brass	200-550		20.0-95.3	40-173		
bronze	300-700			60-290		
copper	200-690			45-315		

TECHNOBEARING

018.202 Technobearing 201 (RUB)

Digital thickness gauge

This thickness gauge measures non-destructively the thickness and speed of sound from several materials according to the ultrasonic measuring principle (as illustrated).

- Measuring principle: ultrasonic.
- Measuring range for steel: 1.2 - 200 mm.
- Resolution: 0.1 mm.
- Accuracy: $\pm (0.5\%H + 0.1 \text{ mm})$ (H = measured value).
- Measuring frequency: 5 MHz.
- Speed of sound: 1000 - 9000 m/s.
- mm/inch conversion.
- RS232C data output.
- On/off switch.
- Automatic switch-off.
- 11 presets for the speed of sound of various materials (cd01 - cd11) and one configurable speed of sound (cd12).

- Calibration standard on side of basic instrument.
- Operating temperature: 0 to 50°C.
- Admissible relative humidity: <80%.
- Dimensions: 120 x 60 x 30 mm.
- Weight basic instrument: 260 g.
- Power supply: 4 batteries type AAA.

Test block for calibration (909.398)

For the inspection and calibration of digital thickness gauges.

- Heights: 2.5 - 25 mm, incr. 2.5 mm.
- Tolerance: 0.1 mm (flatness: $\pm 0.05 \text{ mm}$).
- Material: steel.

TECHNOBEARING

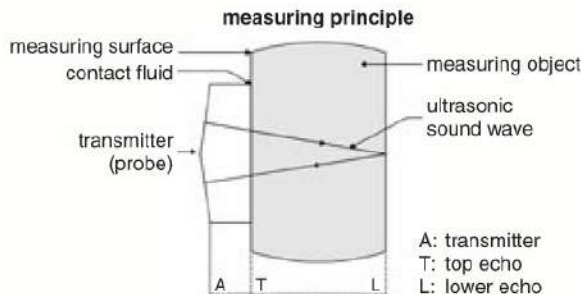

Delivery including:

- small, rectangular probe (measuring face $\varnothing 10 \text{ mm}$),
- contact fluid,
- manual,
- 4 batteries.



Preset code	Material
cd01	steel
cd02	cast iron
cd03	aluminum
cd04	copper (red copper)
cd05	brass
cd06	zinc
cd07	quartz glass
cd08	polyethylene
cd09	PVC
cd10	gray cast iron
cd11	nodular/ductile cast iron

Item No.	Description	Price RUB
909.139	Thickness gauge	
Options:		
497.914	Spare battery (4 needed)	
909.075	RS232C cable and software	
909.576	Contact fluid (approx. 75 ml)	
909.398	Test block for calibration	

909.398



018.307 Technobearing 201 (9628)

Digital thickness gauges

This thickness gauge measures non-destructively the thickness and speed of sound from several materials according to the ultrasonic measuring principle. The Echo-Echo model is capable of measuring the material thickness even through coatings.

- Resolution: 0.1 mm or 0.01 mm.
- Accuracy (H = measured value):
 - 0.65 - 9.99 mm: ± 0.04 mm,
 - 10.00 - 99.99 mm: $\pm (0.1\%H + 0.04$ mm),
 - 100.0 - 400.0 mm: $\pm 0.3\%H$.
- Measuring frequency: 5 MHz (standard probe).
- 9 preset materials (aluminum, titanium, steel, stainless steel, glass, copper, cast iron, brass and polystyrene) and one configurable speed of sound.
- mm/inch conversion.
- LCD display with backlight.
- On/off/reset switch.
- Automatic switch-off.
- Calibration standard on side of basic instrument.
- Operating temperature: -20 to 50°C.
- Dimensions: 116 x 64 x 27 mm.
- Weight basic instrument: 220 g.
- Delivery including inspection report (standard probe).
- Delivery including contact fluid.
- Power supply: 2 batteries type AAA.

Standard model

- Measuring range: 0.8-300 mm (standard probe).
- Delivery including standard probe (909.570).

Echo-Echo model

Echo-Echo mode is only available with the standard probe, 909.575.

- Measuring range:
 - normal mode: 1.44-200 mm (standard probe),
 - Echo-Echo mode: 3-25 mm (standard probe).
- Maximum coating thickness: 2 mm.
- Delivery including standard probe (909.575).

Models with USB output only

- Tolerance settings with alarm function.
- Memory for 5000 measurements.
- Delivery including USB cable.



Item No.	Description	Price RUB
Thickness gauges:		
909.566	Without USB data output	
909.567	With USB data output	
Echo-Echo model:		
909.568	Without USB data output	
909.569	With USB data output	
Options:		
497.914	Spare battery (2 needed)	
909.576	Contact fluid (approx. 75 ml)	
909.398	Test block for calibration	

Test block for calibration (909.398)

For the inspection and calibration of digital thickness gauges.

- Heights: 2.5 - 25 mm, incr. 2.5 mm.
- Tolerance: 0.1 mm (flatness: ± 0.05 mm).
- Material: steel.



Optional probes

Item No.	Mode	Measuring range/mm	Measuring frequency MHz	Minimum tube diameter/mm	Price RUB
909.570		0.8 - 300	5	$\phi 20 \times 1.2$	
909.572		0.65 - 20	10	$\phi 10 \times 4.0$	
For Echo-Echo model only:					
909.575	Normal	3.0 - 25	5	$\phi 25 \times 3$	
	Echo-Echo	1.44 - 200			

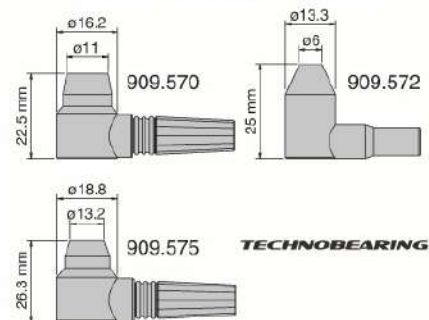

Digital coating thickness gauges

Measurements of coating thickness of paint, coating, foil etc. (non-magnetic layers) on a magnetic (ferro) and/or non-magnetic (non-ferro) metal substrate. Available with integrated or external sensor, in single or combined (automatically selecting magnetic/non-magnetic) model. Furthermore there is a one-button model, specifically designed for the automobile industry.

- Measuring principles: magnetic induction (ferro) and eddy current (non-ferro).
- Measuring range: 0-1250 µm.
- Resolution: 0.1 µm (<100 µm), 1 µm (≥100 µm).
- Accuracy: ±3%H or 3 µm (H = measured value).
- µm/mil conversion.
- RS232C data output.
- Automatic switch-off.
- Minimum measuring area: 6 x 6 mm.
- Minimum substrate thickness: 0.3 mm.
- Minimum object radius:
ferro: 1.5 mm (convex), 25 mm (concave),
non-ferro: 3 mm (convex), 50 mm (concave).
- Dimensions: 131 x 65 x 28 mm.
- Delivery in a case with ferro and non-ferro base plate and reference standards.
- Power supply: 4 batteries type AAA.



909.070



909.072



TECHNOBEARING



909.062

Item No.	Type/description	Price RUB
With integrated sensor:		
909.060	Ferro	
909.069	Non-ferro	
909.070	Non-ferro and ferro	
With external sensor:		
909.061	Ferro	
909.071	Non-ferro	
909.072	Non-ferro and ferro	
One-button model:		
909.062	Non-ferro and ferro	
Options:		
497.914	Spare battery (4 needed)	
909.073	RS232C cable and software	

Digital coating thickness gauge

Measurements of coating thickness of paint, coating, foil etc. (non-magnetic layers) on a magnetic (ferro) and non-magnetic (non-ferro) metal substrate.

- Measuring principles: magnetic induction (ferro) and eddy current (non-ferro).
- Measuring range: 0- 1300 μm .
- Resolution: 1 μm (0- 999 μm), 10 μm (1000- 1300 μm).
- Accuracy: $\pm(3\%+2 \mu\text{m})$.
- Statistics: number of measurements, mean, minimum, maximum and standard deviation.
- $\mu\text{m}/\text{mil}/\text{mm}$ conversion.
- USB data output.
- Illuminated LED display.
- On/off switch.
- Automatic switch-off.
- Minimum measuring area: $\varnothing 6 \text{ mm}$.
- Minimum substrate thickness:
ferro: 0.5 mm, non-ferro: 0.3 mm.
- Minimum object radius:
1.5 mm (convex), 25 mm (concave).
- Maximum measuring frequency: 2 times per second.
- Adjustable tolerance limits (alarm signal on display and acoustic).
- Operating temperature: 0 to 40°C.
- Admissible relative humidity: 20-90%.
- Dimensions: 110x53x24 mm.
- Weight: 92 g.
- Delivery in a case with USB cable, software, ferro and non-ferro base plate, reference standards and an inspection report.
- Power supply: 2 batteries type AAA.

TECHNOBEARING



Item No.	Description	Price RUB
909.116	Coating thickness gauge	
Option:		
497.914	Spare battery (2 needed)	

019.316 Technobearing 201 (94625)

Digital thermometer

- Measuring range: -50 to 750°C.
- Resolution: 1°C.
- Accuracy (H = measured value):
 - 50 to -20°C: ±4°C,
 - 20 to 0°C: ±3°C,
 - 0 to 750°C: ±(0.75%H+1°C).
- On/off switch.
- Hold function.
- Delivery incl. TP01 probe (909.076).
- Weight (incl. battery): approx. 150 g.
- Power supply: 1 battery type PP3 (9 V).



Item No.	Measuring range/°C	Price RUB
909.145	-50 to 750	
Option:		
495.161	Spare battery	



Item No.	Type	Measuring range/°C	Applications	Material probe	Price RUB
909.076	TP01	-50 to 204	air	steel	
909.077	TP02	-50 to 700	air, steam, liquids	stainless steel	

Contact thermometers

These contact thermometers are very suitable for the accurate and fast determination of the workpiece temperature, for example for carrying out temperature-corrected measurements. The contact surfaces are excellent heat conductors, allowing you to measure the exact workpiece temperature within a few minutes.

- Measuring range: 16-26°C.



NEW

TECHNOBEARING

633.250

633.251

Item No.	Measuring range/°C	Graduation °C	Total length (incl. base)/mm	Dimensions base l x w x h/mm	Weight kg	Price RUB
633.250	16-26	0.2°C	110	10 x 10 x 25	0.025	
633.251	17-23	0.1°C	100	10 x 10 x 25	0.025	

018.3D4 Technobearing 201 (06/23)

Infrared thermometers

These hand-held infrared thermometers are extremely suitable for fast non-contact temperature measurements. Equipped with laser for easy aiming at the object. With adjustable emissivity for different surfaces. Applications: for example in the food, automotive and chemical industries, in the process technology and for research purposes.

- Measuring range: -60 to 760°C.
- Resolution: 0.1 or 0.2°C.
- Accuracy: ±2°C or ±2%.
- °C/°F conversion.
- Emissivity preset (standard 0.95).

- Automatic switch-off.
- Hold function.
- Min/max function.
- Operating temperature: 0 to 50°C.
- Measuring time: 1000 ms.
- Laser: 635-660 nm, class 2.

Models

The infrared thermometers have different optics ratios, which makes them applicable for different working distances:

- 908.800: for measurements at small distances,
- 909.413: with a fixed small working distance and a dual laser pointer for targeting,
- 909.412: for measurements at large distances or with a large temperature range.

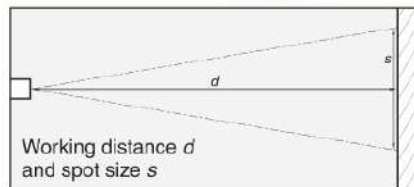

Material	T/°C	Emissivity
Cement	0-200	0.96
Cloth	93	0.90
Paper	38-371	0.93
Granite	21	0.45
Steel	25	0.65
Cast iron	100	0.21
Cold milled steel	93	0.75-0.85
Stainless steel	24	0.28
White alumina ceramics	93	0.90
Hard rubber	23	0.94
Soft rubber	24	0.86

Item No.	908.800	909.413	909.412
Price RUB			
Measuring range °C	-55 to 250	-55 to 220	-60 to 760
Working distance <i>d</i>	small	18 mm	large
Optics ratio <i>d</i> : <i>s</i>	6:1	(<i>s</i> = 2.5 mm)	30:1
Resolution °C	0.1	0.2	0.1
Wave length μm	5-14	5-14	8-14
Laser pointer	✓	✓ (dual)	✓
Emissivity	0.05-1 (incr. 0.01)	0.05-1 (incr. 0.01)	0.10-1 (incr. 0.01)
Emissivity preset	0.95	0.95	0.95
Illuminated LCD display	-	-	✓
Dimensions mm	103 x 50 x 23	171 x 41 x 27	146 x 133 x 49
Weight (incl. batteries) g	65	125	222
Power supply (batteries)	2x CR2032	2x AAA	2x AAA

Spare batteries

Item No.	Type	Price RUB
495.157	CR2032	
497.914	AAA	

019.301. Technobearing 201 (9625)

Digital thermometer

- Measuring range: -40 to 200°C.
- Resolution: 0.1°C.
- Accuracy:
 - 0 to 100°C: ±1°C,
 - 100 to 200°C: ±2°C.
- Stainless steel measuring pin.
- °C/°F conversion.
- On/off switch.
- Power supply: 1 battery type V357.



TECHNOBEARING



Item No.	Measuring range/°C	Price RUB
909.421	-40 to 200	
Option:		
836.535	Spare battery	

Digital thermal imager

With this thermal imager one can easily measure and display (2.8" LCD color display) the thermal image and temperature.

- Measuring range: -20 to 250°C.
- Field of view: 40x40°.
- Accuracy: ±2°C or ±2%.
- Thermal sensitivity: 0.1°C.
- Thermal image resolution: 32 x 31 px.
- Emissivity preset: 0.95, selectable 0.10 - 1.00 per 0.01.
- USB data output.
- On/off switch.
- Automatic switch-off.
- Adjustable tolerance limits.
- Backlight with 3 selectable levels of brightness.
- °C/°F/°K conversion.
- 4 selectable color palettes.
- Alarm for adjustable upper and lower limit of the temperature.
- Frame rate: 9 Hz.
- Spectral range: 8 - 14 μm.
- Time stamp for images.
- Storage for 25000 images.
- Memory card: micro SDHC 8 GB, including adapter for SD card reader.
- Dimensions: 95 x 75 x 233 mm.
- Weight (incl. batteries): 390 g.
- Protection: IP54.
(When using data output: IP40.)
- Delivery in a case with USB cable and software.
- Power supply: 4 batteries type AA.



Item No.	Description	Price RUB
909.429	Thermal imager	
Option:		
495.111	Spare battery (4 needed)	

019.002 Technobearing 201 (9625)

Digital thermohygrometer

- Measuring range: -10 to 50°C, 5-98%RH (with no condensation).
- Resolution: 0.1°C, 0.1%RH.
- Accuracy temperature: ±1°C.
- Accuracy relative humidity at 25°C: ≤30%RH: ±5%RH, >30%RH: ±3%RH.
- °C/°F conversion.
- Measuring frequency: 2.5 times per second.
- Illuminated LCD display.

- On/off switch.
- Automatic switch-off.
- Hold and min/max functions.
- Dimensions: 151 x 83 x 26.5 mm.
- Weight: 251 g.
- Delivery in a case.
- Power supply: 1 battery type PP3 (9 V).



Item No.	Measuring range/°C	Measuring range/%RH	Price RUB
909.130	-10 to 50	5-98	
Option:			
495.161	Spare battery		

TECHNOBEARING

Digital thermohygrograph for permanent monitoring

The new technology for permanent 24 hours registering and checking the temperature and humidity in the area and measuring rooms. Typical metrology room temperature is 20±0.05°C, with a resolution of 0.1°C for registering the temperature.

- Measuring range: -10 to 60°C, 0-100%RH (with no condensation).
- Resolution: 0.01°C, 0.1%RH.
- Accuracy temperature: ±(0.1 + |T-20|/250)°C (T in °C).
- Accuracy relative humidity: 4%RH.
- °C/°F conversion.
- Min/max/P-P function.
- Stand-alone: memory for 500 000 measurements (interval: adjustable).
- Data-logger with Bluetooth, SD card and USB connection for data analysis (initial settings via PC).
- Including software for Windows (7 or later) and app for Android and iOS.

- Audiovisual alarms: temperature: 2 upper and 2 lower limits, humidity: 4 limits, temperature change: 2 limits.
- Graphs: on e-paper display or PC.
- Including wall support and desk stand.
- Dimensions: 75 x 110 x 30 mm.
- Delivery in a case.
- Power supply: 2 batteries type AA or USB (adapter not supplied).



Item No.	Description	Price RUB
837.800	Thermohygrograph	
Option:		
495.111	Spare battery (2 needed)	

018.006 Technobearing 201 (9625)

Digital tachometers – contact, laser, laser/contact

With these digital laser tachometers very accurate non-contact and/or contact measurements can be done easily.

- Measuring range contact: 0.5 - 19999 rpm,
0.05 - 1999.9 m/min.
- Measuring range laser: 2.5 - 99999 rpm.
- Resolution:
 - < 1000 rpm: 0.1 rpm,
 - ≥ 1000 rpm: 1 rpm,
 - < 100 m/min: 0.01 m/min,
 - ≥ 100 m/min: 0.1 m/min.
- Range: 5 - 50 cm (laser).
- Accuracy: ±(0.05% + 1 digit).
- Laser/contact switchable (909.146).
- Automatic switch-off.
- Functions: max., min. and last measured value.
- Dimensions and weight:
 - 909.148: 174 x 72 x 38 mm, 240 g,
 - 909.152: 182 x 70 x 34 mm, 170 g,
 - 909.146: 198 x 70 x 34 mm, 225 g.
- Laser class 2 according IEC825-1 and EN60825-1.
- Power supply:
 - 909.148: 4 batteries type AA,
 - 909.152: 3 batteries type AAA,
 - 909.146: 4 batteries type AAA.



909.148



909.152



909.146

TECHNOBEARING



909.348

Item No.	Description	Price RUB
909.148	Digital contact tachometer	
909.152	Digital laser tachometer	
909.146	Digital laser/contact tachometer	
Options:		
497.914	Spare battery type AAA	
495.111	Spare battery type AA	
906.811	Reflective tape per meter (width 25 mm, for laser tachometers)	
909.348	Set contact points for tachometers 909.146/148	

D18.008 Technobearing 201 (90925)

Digital torquemeters

Instrument for the testing and measuring of torque.

- Measuring range: 0- 500 N·m.
- N·m/kgf·cm/lbf·inch conversion.
- RS232C data output.
- Automatic switch-off.
- Peak hold function.
- Go/NoGo tolerance evaluation.
- Memory for 10 values.
- Average value calculation.
- Weight: 2.4 kg (model I) or 22 kg (model II).
- With built-in printer (only model II).
- Delivery with an RS232C cable.
- Power supply: AC adapter 220 V, 300 mA (model I) or 220±10% V, 100 W (model II).



PRICE

TECHNOBEARING

Item No.	Measuring range/N·m	Resolution N·m	Accuracy	Price RUB
With integrated sensor (model I):				
909.370	0- 1	0.0005	±0.5%	
909.371	0- 5	0.002	±0.5%	
909.372	0- 10	0.005	±0.5%	
With external sensor (model II):				
909.373	0- 50	0.02	±1%	
909.374	0-100	0.05	±1%	
909.375	0-500	0.2	±1%	
Option:				
900.825	Printing paper (5 rolls)			

018.317. Technobearing 201 (9628)

Strain gauges

Handy measuring instruments suitable for measurements in two directions. Used to check the measuring force of dial indicators, lever type indicators, CMM probes etc. Small model with flat touch surface has a $\varnothing 1$ mm bore. Large model with curved touch surface of $\varnothing 3.5$ mm.

- Measuring range: 0.01 - 20 N or 1 - 2000 g.
- Indication accuracy:
±2% of the entire scale except 910.143 and 910.149: ±2.5%.
- With peak pointer.
- Metal housing.
- Delivery in a case.

NEW



910.138

TECHNOBEARING



910.149

Newton model

Item No.	Measuring range/N	Graduation N	Price RUB
Small model:			
910.138	0.01 - 0.05	0.001	
910.139	0.025 - 0.15	0.005	
910.140	0.1 - 0.5	0.01	
910.141	0.25 - 1.5	0.05	
910.142	1 - 5	0.1	
Large model:			
910.143	4 - 20	0.5	

Gram model

Item No.	Measuring range/g	Graduation g	Price RUB
Small model:			
910.144	1 - 5	0.1	
910.145	2.5 - 15	0.5	
910.146	10 - 50	1	
910.147	25 - 150	5	
910.148	100 - 500	10	
Large model:			
910.149	500 - 2000	50	

Strain gauges

Handy strain gauges suitable for measurements in two directions.

- Measuring range: 0.005 - 100 N.
- Indication accuracy: $\pm 2\%$ of the entire scale.
- With peak pointer.



857.701

TECHNOBEARING



857.724

Small model

Item No.	Measuring range/N	Graduation N	Price RUB
857.701	0.005 - 0.05	0.001	
857.702	0.015 - 0.15	0.005	
857.703	0.03 - 0.3	0.01	
857.704	0.05 - 0.5	0.01	
857.705	0.1 - 1	0.02	
857.706	0.15 - 1.5	0.05	
857.707	0.25 - 2.5	0.05	

Large model

Item No.	Measuring range/N	Graduation N	Length mm	Price RUB
857.721	0.25 - 2.5	0.05	153.5	
857.722	1 - 5	0.1	153.5	
857.725	3 - 30	0.5	153.5	
857.726	4 - 40	1	153.5	
857.727	5 - 50	1	127.5	
857.728	10 - 100	2	127.5	

Strain gauges

Handy measuring instruments suitable for measurements in two directions. Used to check the measuring force of dial indicators, lever type indicators, CMM probes etc. The flat touch surface has a $\phi 1$ mm bore.

- Measuring range: 2 - 500 gram.
- Indication accuracy: $\pm 4\%$ of the entire scale.

- With peak pointer.



Item No.	Measuring range/g	Graduation g	Price RUB
909.391	2 - 10	0.5	
909.392	5 - 30	1	
909.393	10 - 50	2	
909.394	20 - 100	5	
909.395	25 - 150	5	
909.396	50 - 300	10	
909.397	100 - 500	20	

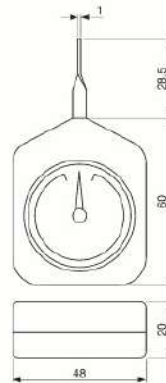

909.395

017_3D1 Technobearing 201 (06/23)

Digital spring scales

- Measuring range: 0-25 kg.
- Resolution: 0.005, 0.01 or 0.02 kg.
- Kg/lbs conversion.
- Automatic switch-off.
- Reset at weight empty box possible.
- Automatic hold function.
- Memory for maximum weight.

- Dimensions and weight:
909.126: 100x 58x22 mm, approx. 100 g,
909.123/124: 149x 100x 35 mm, approx. 200 g.
- Power supply:
909.126: 3 batteries type AAA,
909.123/124: 1 battery type PP3 (9 V).

Item No.	Measuring range/kg	Resolution kg	Accuracy kg	Price RUB
909.126	0- 5	0.005	±0.02	
909.123	0- 10	0.01	±0.01	
909.124	0- 25	0.02	±0.02	

Options:
497.914 Spare battery type AAA
495.161 Spare battery type PP3



Dynamometers

Robust dynamometers in analog and digital model with several set-up pieces.

- Measuring range: 0-500 N.
- Push and pull.
- Max/peak function.

Analog

- Accuracy: ± 1%.
- Graduation: N and kg.
- With 4 tapped holes M3 (for mounting).
- Dimensions: 225 x 60 x 51 mm.
- Weight: approx. 600 g.

Digital

- Accuracy: ±0.2%.
- Kg/lb/N conversion.
- On/off switch.
- Automatic switch-off.
- Reversible display value.
- With 4 tapped holes M4 (for mounting).
- Dimensions: 147 x 75 x 38 mm.
- Weight: approx. 400 g.
- Power supply: AC adapter (12 Vdc, 1 A) and rechargeable battery.

TECHNOBEARING



909.174

909.182

Item No.	Measuring range/N	Reading N	Price RUB
Analog:			
909.175	0- 10	0.05	
909.178	0- 50	0.2	
909.180	0-200	1	
909.182	0-500	2	
Digital:			
909.168	0- 5	0.001	
909.169	0- 10	0.01	
909.171	0- 50	0.01	
909.173	0-200	0.1	
909.174	0-500	0.1	



Digital vibration tester

Instrument with external sensor for quick checking of unbalance, misalignment, bearings and gears. For measuring velocity, acceleration, displacement and frequency.

Measuring range

- Velocity: 0.01 - 99.99 mm/s, 100.0 - 400.0 mm/s (RMS, at frequency 10 Hz - 1 kHz).
- Acceleration: 0.1 - 400 m/s² (peak value, at frequency 10 Hz - 1 kHz or 10 Hz - 10 kHz).
- Displacement: 0.001 - 4.0 mm (P-P, at frequency 10 Hz - 1 kHz).
- Frequency: 0.1 - 20 kHz.

Further specifications

- Accuracy: ± 5% + 2 digits.
- mm/inch conversion.
- RS232C data output.
- Operating temperature: 0 to 50°C.
- Dimensions: 125 x 62 x 31 mm.
- Weight: 255 g.
- Delivery in a case, incl. magnet and 2 attachments.
- Delivery with an inspection report.
- Power supply: 4 batteries type AAA.



Item No.	Description	Price RUB
909.065	Vibration tester	
Options:		
497.914	Spare battery (4 needed)	
909.074	RS232C cable and software	

Digital sound level meter

Instrument for measuring the sound level.

- Measuring range: 30- 130 dB.
- Resolution: 0.1 dB.
- Accuracy: ± 1.5 dB.
- Frequency weighting: A and C.
- Frequency range: 31.5 Hz - 8.5 kHz.
- Measuring frequency: 2 times per second.
- Time weighting: fast/slow.
- The current measured value within the range of 50 dB is graphically displayed (adjustable).
- Over range indication.
- Automatic switch-off.
- Max function.
- Dimensions: 207 x 70 x 29 mm.
- Weight: 178 g.
- Delivery in a case.
- Power supply: 1 battery type PP3 (9 V).

TECHNOBEARING



Item No.	Measuring range/dB	Price RUB
909.131	30 - 130	
Option:		
495.161	Spare battery	

Refractometers

Refractometers for regular checking the correct mixing ratio of coolants. A correct proportion is very important.

- Measuring range: 0-32% Brix.
- Graduation: 0.1 or 0.2% Brix.
- Accuracy: $\pm 0.2\%$.
- Adjustable eyepiece.
- Adjustment screw for zero setting (protected by rubber cap).
- Rubber eye adapter.
- Ergonomic design.
- Weight: 200 g.
- Delivery in a case incl. cleaning cloth, screwdriver, pipette.



909.079



Item No.	Meas. range % Brix	Graduation % Brix	Price RUB
909.090	0 - 10	0.1	
909.079	0 - 32	0.2	

TECHNOBEARING

Telescopic mirror/magnet

- Adhesive force magnet: 5 N.
- Max. length (extended length): 480 mm.



909.343

909.344



Item No.	Description	Price RUB
909.343	Telescopic mirror	
909.344	Telescopic magnet lifter	

Sonarscope

For tracing mechanical problems by means of sound.



Item No.	Description	Price RUB
909.418	Sonarscope	

018.316 Technobearing 201 (9625)

DeMeet 3D CNC coordinate measuring machines DF fixture system

DeMeet coordinate measuring machines

The DeMeet 3D CNC coordinate measuring machines provide automatic, user-independent quality control with measuring results traceable to the international length standard. The DeMeet measuring machines are available in Video (optical) and Combo model (multi-sensor for combined video and touch probe measurements).

The application of quality components made by Schut and by well-known, specialized manufacturers ensures excellent performance and high accurate measurements.

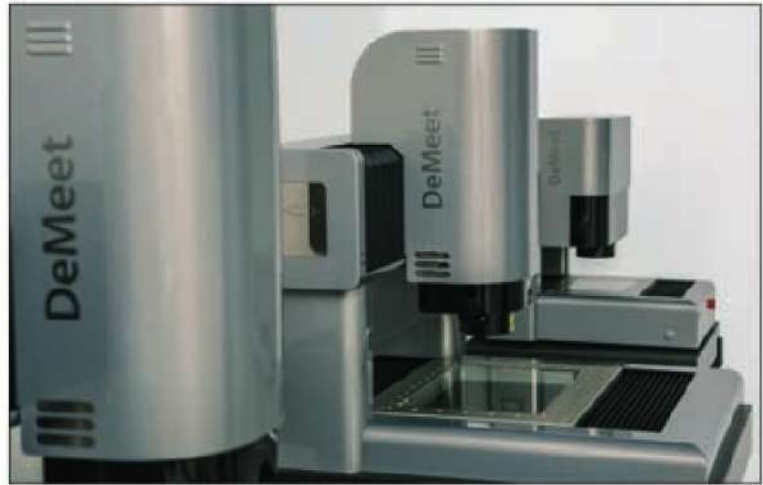

DeMeet video measuring machines

Optical measurements are performed using the camera system, optics and adjustable illumination. Due to the non-contact nature of the measurements there is no risk of product deformation. Optical measuring is very suitable for products with fine structures and contact sensitive products.

Optical system

A combination of high quality telecentric optics and DeMeet Sony sensor camera is integrated for a clear image with an excellent contrast and a high resolution. In combination with the image processing functionality of the DeMeet, this results in highly accurate measurements.



TECHNOBEARING



Illumination

Illumination is essential for accurate measurements. The DeMeet is standard equipped with LED based illumination (backlight, coaxial light and segmented ring light). A ring light consisting of a 3 rings, 16 segments and 48 cells LED pattern, that can be controlled per individual ring, segment and cell, is standard supplied for optimal light configuration.

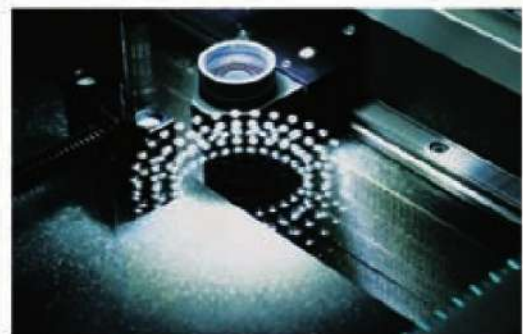

CE3_3D1_ Technobearing_201 (9x625)

DeMeet video and multi-sensor measuring machines



DeMeet multi-sensor measuring machines

The increasing miniaturization and complexity of product features results in more difficult measuring and inspection procedures. Measuring systems equipped for only optical or contact measurements are often no longer sufficient, in which case multi-sensor measuring machines are required for optimal geometrical quality control.

With the DeMeet Combo model both optical and contact measuring principles are seamlessly integrated and measurements can be performed by the optical and the probing system within one measuring run and even within one feature.

TECHNOBEARING

PTB software evaluation

Evaluation software for coordinate measuring machines. The accuracy of the *Approve for DeMeet* software was verified by comparing the results obtained from the software with reference results

supplied by the PTB (Physikalisch-Technische Bundesanstalt, Braunschweig, Germany). The *Approve for DeMeet* software has been placed in the class of the smallest deviations.



Approve for DeMeet multi-sensor measuring software

Approve for DeMeet is a true multi-sensor software package, where the difference in sensor origin of the measuring input is limited to only the necessary. All the measuring results of video and touch probe can be displayed, reported, exported and used in constructs together, and are dynamically updated. The measuring results can also be displayed together in a 3D view. *Approve for DeMeet* is designed to be a user-friendly software package, but is flexible and very elaborate to measure many products.

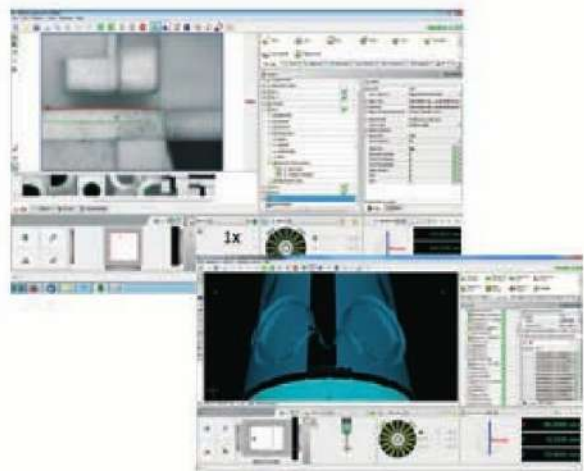

CE31_3Dx2 Technobearing 201 (KRE23)

Fixture systems

Solid positioning of a measuring object with a fixture system is essential for accurate measurements.

DF product fixture system

DF-System is a fixture system developed and produced by Schut and designed for constructing 3D product fixtures, particularly for optical measurements, and is fully compatible with the measuring table of the DeMeet measuring machines. The DF-system is an easy to mount measurement fixture system and especially developed to use the most of the illumination possibilities for optical measurements. Easy to mount with single-screw couplings to build fixtures with a high repeatability and to realize a short set-up time for measuring tasks.

DF is available in separate components and in three basic sets.

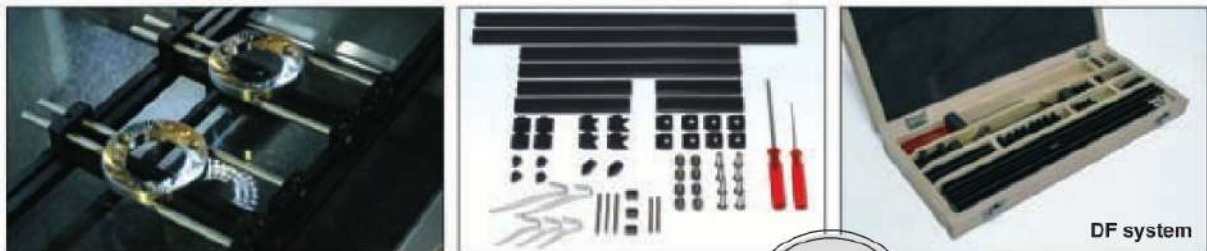

TECHNOBEARING

Download the
brochure from
Schut.com

Custom fixture systems

When products need to be measured in a batch and a standard fixture system does not provide the right solution for example caused by the extraordinary shape or small dimensions of the product, a custom made fixture can provide the solution. This is especially the case for products that need to be measured optically.

A certain repeatability of product positioning in the fixture is important for a quick set-up time in for example the production environment. We can assist you in the development and manufacturing of a custom fixture. There is a range of possibilities, from machined fixturing positions in acryl glass to magnet and vacuum fixture systems.

