

PHE 1100TGHCOVER

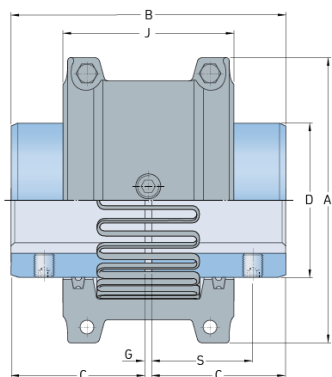

Size	1100
Nominal torque (Nm)	6280
Max speed (r/min)	2440
Min. bore (mm)	41
Max. bore (mm)	107
Weight (kg)	4.6