

Все шкивы под клиновые ремни изготовлены в соответствии с нормами ISO 4183 и DIN 2211-3.

В качестве материала для изготовления данных шкивов используется литейный чугун EN-GJL-200 UNI EN 1561. После механической обработки все шкивы подвергаются фосфатированию.

Для всех шкивов выполнена статическая балансировка и они пригодны для окружных скоростей до 35 м/с.

В настоящем каталоге предлагаются шкивы для клиновых ремней SPZ, SPA, SPB, SPC под втулку тапербуш, а также с черновым отверстием под расточку.

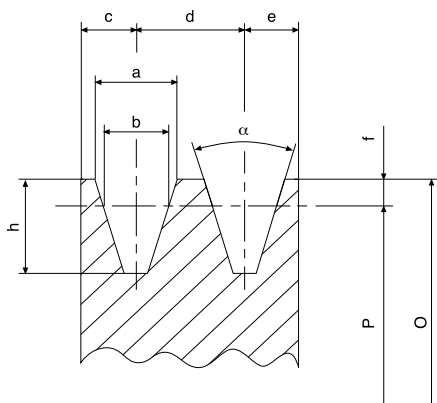

Расчет окружной скорости V_p в м/с:

$$V_p = \frac{\pi \cdot P \cdot n}{60 \cdot 1000} \approx \frac{P \cdot n}{19100}, \quad V_p \leq 35 \text{ м/с}$$

где:

P – расчетный диаметр, мм

n – скорость вращения, об./мин

Размеры канавок

Профиль канавки	a, мм	b, мм	c, мм	d, мм	e, мм	f, мм	h, мм	$\alpha = 34^\circ$	$\alpha = 38^\circ$
SPZ	9,7	8,5	8	12	8	2	11	$P \leq 80$	$P > 80$
SPA	12,7	11	10	15	10	2,8	13,8	$P \leq 118$	$P > 118$
SPB	16,3	14	12,5	19	12,5	3,5	17,5	$P \leq 190$	$P > 190$
SPC	22	19	17	25,5	17	4,8	23,8	$P \leq 315$	$P > 315$

Размеры ремня

Профиль	m, мм	s, мм	n, мм
SPZ	9,7	8	8,5
SPA	12,7	10	11
SPB	16,3	13	14
SPC	22	18	19

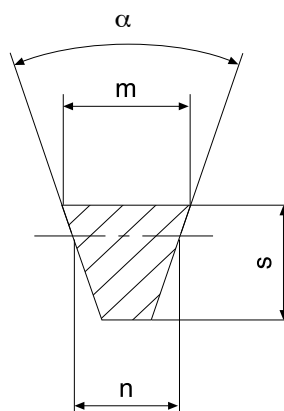

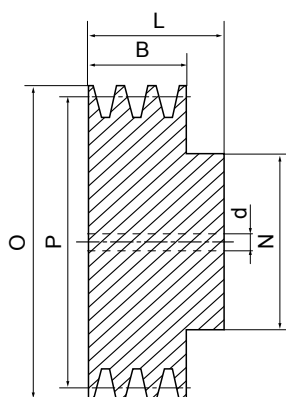

исп. 1

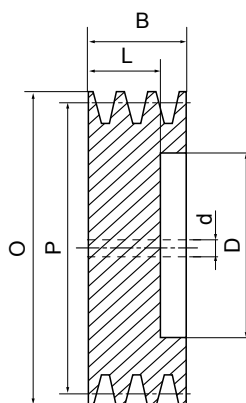

исп. 2

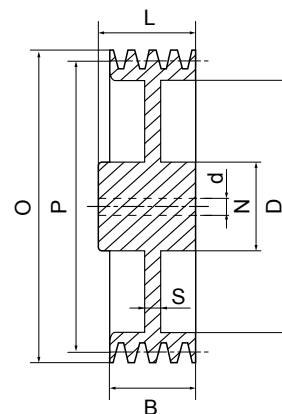

исп. 3

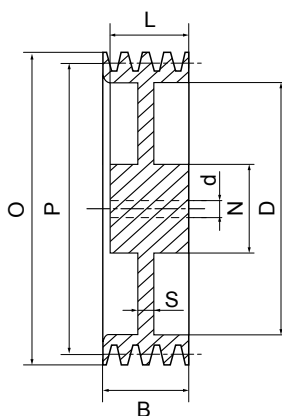

исп. 4

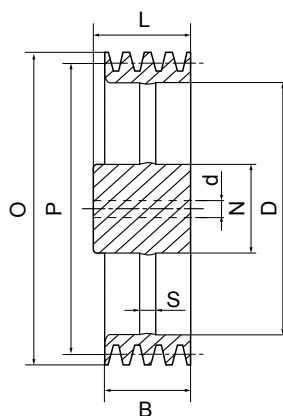

исп. 5

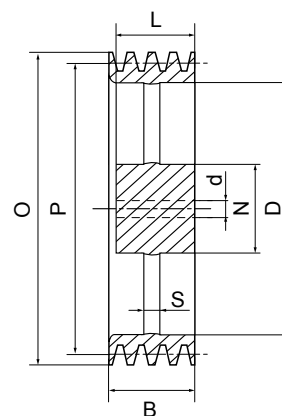

исп. 6

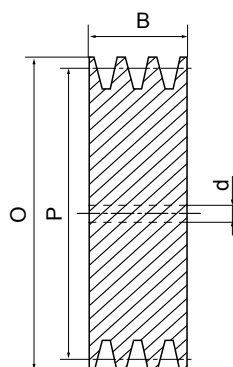

исп. 7

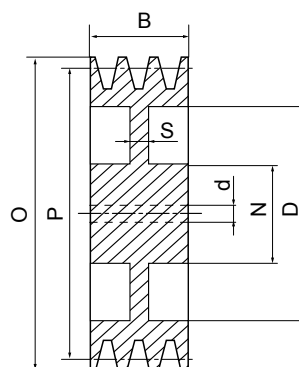

исп. 8



SPB

КОД	Тип	P, мм	O, мм	Количество канавок	N, мм	L, мм	D, мм	S, мм	B, мм	Исп.	d, мм
BM00631	SPB63	63	70	1	45	45			25	1	10
BM00701	SPB70	70	77	1	45	45			25	1	10
BM00702				2	45	55			44	1	10
BM00713	SPB71	71	78	3					63	7	15
BM00801	SPB80	80	87	1	50	45			25	1	10
BM00802				2	50	55			44	1	10
BM00803				3					63	7	15
BM00804				4					82	7	15
BM00805				5					101	7	15
BM00851	SPB85	85	92	1	50	45			25	1	10
BM00852				2	50	55			44	1	10
BM00853				3					63	7	15
BM00901	SPB90	90	97	1	50	45			25	1	10
BM00902				2	50	55			44	1	10
BM00903				3					63	7	15
BM00904				4					82	7	15
BM00905				5					101	7	15
BM00951	SPB95	95	102	1	50	45			25	1	10
BM01001	SPB100	100	107	1	52	45			25	1	10
BM01002				2	55	55			44	1	15
BM01003				3					63	7	15
BM01004				4					82	7	15
BM01005				5					101	7	15
BM01061	SPB106	106	113	1		45			25	1	15
BM01062				2		55			44	1	15
BM01121	SPB112	112	119	1	55	45			25	1	15
BM01122				2	60	55			44	1	15
BM01123				3					63	7	15
BM01124				4					82	7	20
BM01125				5					101	7	20
BM01181	SPB118	118	125	1	55	45			25	1	15
BM01182				2	60	55			44	1	15
BM01183				3					63	7	15
BM01184				4					82	7	20
BM01185				5					101	7	20
BM01186				6					120	7	20
BM01201	SPB120	120	127	1	55	45			25	1	15
BM01202				2	60	55			44	1	15
BM01203				3					63	7	15
BM01204				4					82	7	20
BM01205				5					101	7	20
BM01206				6					120	7	20
BM01251	SPB125	125	132	1	58	45			25	1	10
BM01252				2	60	55			44	1	15
BM01253				3			60	83	63	2	15
BM01254				4			60	83	82	2	20
BM01255				5			60	83	101	2	20
BM01256				6			60	83	120	2	20
BM01321	SPB132	132	139	1	60	45			25	1	15
BM01322				2	60	55			44	1	15
BM01323				3			60	88	63	2	15
BM01324				4			60	88	82	2	20
BM01325				5			60	88	101	2	20
BM01326				6			60	88	120	2	20
BM01401	SPB140	140	147	1	65	45			25	1	20
BM01402				2	65	55			44	1	20
BM01403				3			60	98	63	2	20
BM01404				4			60	98	82	2	20
BM01405				5			60	98	101	2	20
BM01406				6			60	98	120	2	20
BM01501	SPB150	150	157	1	65	45			25	1	20
BM01502				2	65	55			44	1	20
BM01503				3			60	108	63	2	20
BM01504				4			60	108	82	2	20
BM01505				5			60	108	101	2	20
BM01506				6			60	108	120	2	20

