

PHE 1060TGHCOVER

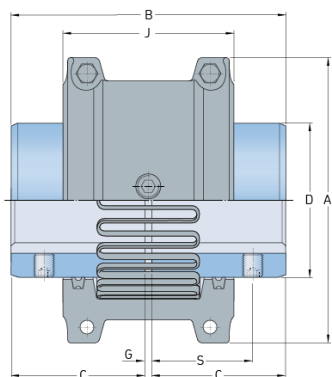

Size	1060
Nominal torque (Nm)	684
Max speed (r/min)	4350
Min. bore (mm)	19
Max. bore (mm)	57
Weight (kg)	1.21