

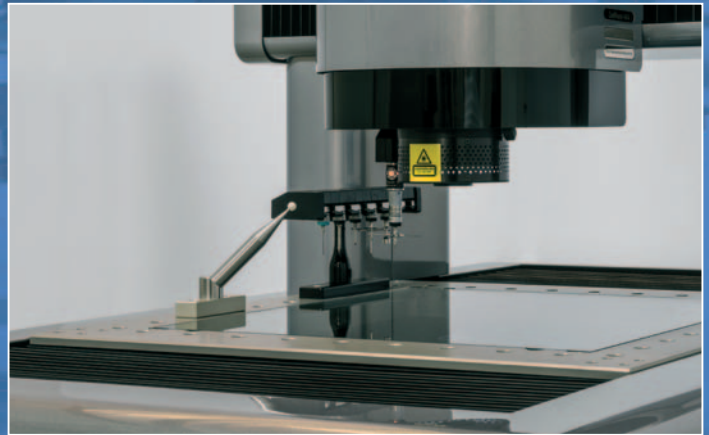

Measuring instruments and systems

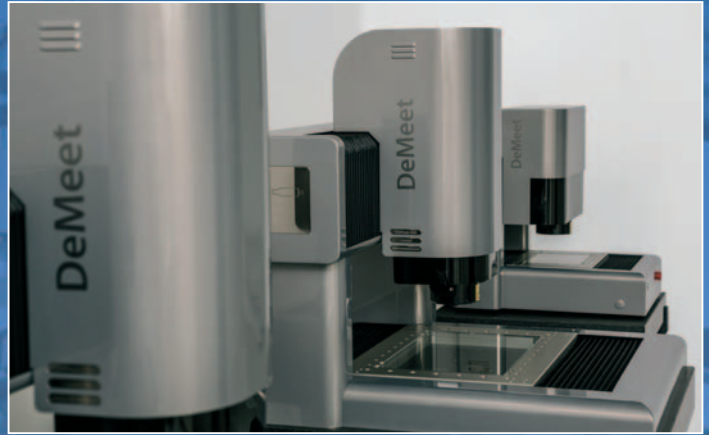

more than
65 YEARS
quality
in Europe

precision measuring instruments
mechanical - optical - electronical
3D CNC coordinate measuring machines

2017/2018

Schut Geometrical Metrology



Schut Netherlands



Schut Belgium



SGM Germany



SGM Switzerland



Schut France



ISO 9001 certification

Schut Geometrical Metrology is ISO 9001-2008 certified. We have established a quality management system that meets the demands of the international quality standards. Our quality management ensures that all activities are comprehensively planned, managed and controlled.

The management of Schut Geometrische Meettechniek b.v. commits itself to conducting all activities in accordance with the defined requirements in the scope of the ISO-9001 declaration.

SCHUT.COM



Expert advice

Our technical advisors provide you a clear explanation and expert advice. Speak directly to a specialist. Our advisors are glad to discuss with you the possibilities and the application of your measuring instruments and e.g. the connection of the instruments to a PC.



Besides products displayed in this catalog, various other products can be supplied. You can also contact us for products that vary with the standard design or for custom measuring fixtures.

Logistics

You can reach our sales department on working days from 8.30 until 17.00. Orders can be placed by e-mail, telephone and post. We guarantee a fast and accurate processing. We aim for orders placed before 15.00 to ship within the same day (provided that the items are on stock). The terms of sales and delivery can be found in the last part of this catalog.

A large stock of products is essential to serve you as quickly as possible. That is why we have more than 170000 items on stock that we ship directly from our warehouse. The order processing is completely automated.



Selection and quality

We aim at supplying a wide lineup of geometrical measuring instruments and systems. In this specialized catalog we made an extensive selection of more than 38000 sales products in different price ranges. Besides products from well-known manufacturers we supply our own brand Filetta with an attractive price.



Calibration service

Some products are supplied with an inspection report or declaration of conformity. In many cases this suits a quality system. When a traceable inspection report is required we can arrange this through one of our calibration-partners.



Service and support

Our specialized service and support departments assist you with various technical assignments.

For repairs, our service department can assist you, with many years of experience in geometrical metrology and a large stock of spare parts. The possibility of performing most repairs internally, saves you cost and time.

Our support department provides you advice, training, online support and custom applications for the DeMeet measuring machines.



Regional coverage

Schut Geometrical Metrology (Schut Geometrische Meettechniek bv) is an international organization, founded in 1949, with five offices throughout Europe, specialized in the development, production and sales of precision measuring instruments and systems.

Service and sales activities are performed by our company group or through an international network of experienced distributors.



Schut in Europe

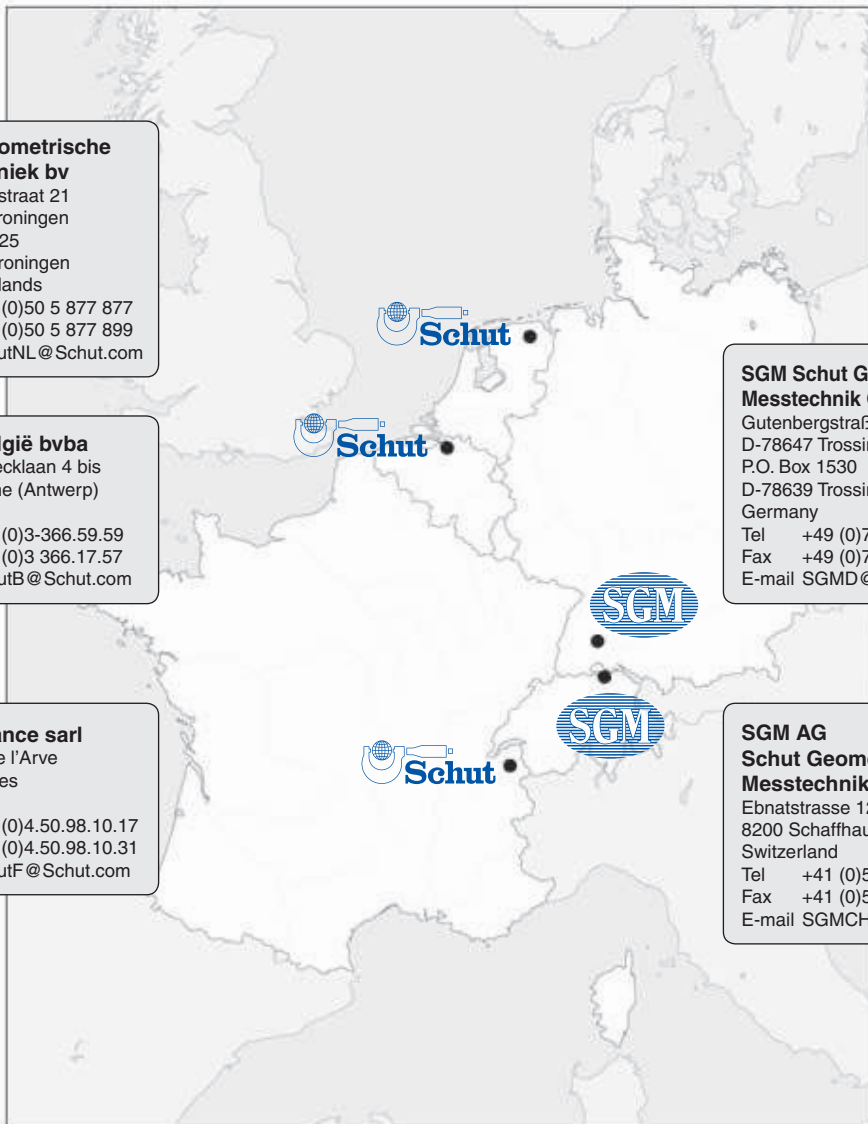

Schut Geometrische Meettechniek bv
Duinkerkenstraat 21
9723 BN Groningen
P.O. Box 5225
9700 GE Groningen
The Netherlands
Tel +31 (0)50 5 877 877
Fax +31 (0)50 5 877 899
E-mail SchutNL@Schut.com

Schut België bvba
Wouter Haecklaan 4 bis
2100 Deurne (Antwerp)
Belgium
Tel +32 (0)3-366.59.59
Fax +32 (0)3 366.17.57
E-mail SchutB@Schut.com

Schut France sarl
105, Rue de l'Arve
74300 Cluses
France
Tel +33 (0)4.50.98.10.17
Fax +33 (0)4.50.98.10.31
E-mail SchutF@Schut.com

SGM Schut Geometrische Messtechnik GmbH
Gutenbergstraße 5
D-78647 Trossingen
P.O. Box 1530
D-78639 Trossingen
Germany
Tel +49 (0)7425 - 312 66
Fax +49 (0)7425 - 312 69
E-mail SGMD@Schut.com

**SGM AG
Schut Geometrische Messtechnik**
Ebnatstrasse 127
8200 Schaffhausen
Switzerland
Tel +41 (0)52 624 00 37
Fax +41 (0)52 624 00 39
E-mail SGMCH@Schut.com



Table of contents

category	page
1 Magnescale digital length measuring and gauge systems	6–30
2 Calipers / Depth calipers and micrometers	31–86
3 Micrometers / Micrometer heads	87–139
4 Internal micrometers / Internal & external measuring instruments	140–202
5 Dial indicators / Dial test indicators / Center instruments Edge finders / Probes / MF measuring fixture system	203–260
6 Stands / Bench centers / Surface plates	261–287
7 V-blocks / Vises / Angle plates / Cylindrical squares Squares / Parallels / Straight edges	288–321
8 Protractors / Clinometers / Spirit levels	322–341
9 Surface roughness testers / Roughness specimens	342–348
10 Gauge blocks / Measuring balls Optical flats and plan parallel optical flats / Feeler gauges	349–368
11 Gauges / Pin gauges / Thread and tolerance tables	369–387
12 Magnifiers / Microscopes / Glass rulers / Stereo microscopes Video microscopes / Endoscopes / Profile projectors	388–418
13 Graduated rulers / Scale units / Circumference tapes Precision tapes / Distance meters	419–433
14 Scribing tools / Compasses / Center squares	434–441
15 Height and scribing gauges / Height gauges	442–459
16 Hardness testers / (Coating) thickness gauges / (Infrared) thermometers Tachometers / Dynamometers / Inspection instruments	460–481
17 Measuring instrument displays and interfaces	482–488
18 DeMeet 3D CNC coordinate measuring machines DF fixture system / Alufix fixture system	489–512
19 Probes and probe systems	513–520
Index	521–528
Terms of sales and delivery	529

Magnescale digital length measuring and gauge systems



Magnescale SJ700A scale systems with favourable price-performance ratio

The SJ700A scales are an excellent choice for applications (lathes, milling machines) where a resolution of 5 µm is sufficient. A real Magnescale with a favourable price-performance ratio.

- Measuring range: 0- 1600 mm.
- Highest resolution: 5 µm.
- Accuracy at 20°C:
 $L \leq 1250 \text{ mm: } \pm 10 \text{ } \mu\text{m,}$
 $L \leq 1600 \text{ mm: } \pm 15 \text{ } \mu\text{m.}$
- Linear expansion coefficient: $(12 \pm 1) \cdot 10^{-6} / ^\circ\text{C.}$
- Operating temperature: 0 to 40°C.
- Cross-section: 24 x 25 mm.
- Total length = $L + 120 \text{ mm.}$
- Cable length (standard):
 $L \leq 800 \text{ mm: } 3 \text{ m,}$
 $L \leq 1600 \text{ mm: } 5 \text{ m.}$
- Resistant to oil, chips and shocks, and reliable in the harshest environments.
- Protection: IP54.



Item No.	Type	Measuring range/mm	Price EUR
346.823	SJ700A-015	150	
346.824	SJ700A-025	250	
346.825	SJ700A-035	350	
346.826	SJ700A-040	400	
346.827	SJ700A-050	500	
346.828	SJ700A-065	650	
346.829	SJ700A-080	800	
346.830	SJ700A-095	950	
346.831	SJ700A-105	1050	
346.832	SJ700A-125	1250	
346.833	SJ700A-140	1400	
346.834	SJ700A-160	1600	
495.302	Mounting kit for lathes		
495.303	Mounting kit for milling machines		
346.867	Adapter cable CK-T157		
For connecting to old display types*:			
346.926	Adapter cable CE30		
346.448	Adapter SZ51-AB01		

* LG10, LH51/52, LH61 and LY51/52.
Both adapter cable and adapter are needed.

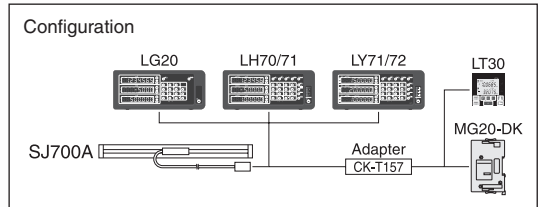
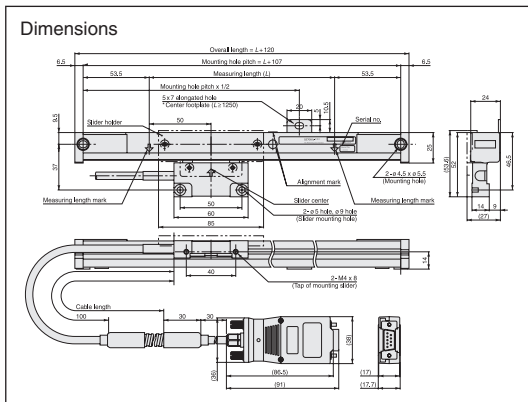

Magnescale GB-ER universal scale systems

The GB-ER beats all competition. An excellent resistance against workshop conditions (oil, chips and shocks), a high resolution (0.5 µm) and an expansion coefficient the same as the machine itself. Reliable for many years and almost maintenance free as all magnetic scales of Magnescale.

- Measuring range: 0 - 2200 mm.
- Highest resolution: 0.5 µm.
- Accuracy at 20°C: $\pm(2.5 + 2.5L) \mu\text{m}$ (L in m).
- Max. measuring speed: 60 m/min.
- Output: A/B phase and reference point Z (TTL line driver RS422).
- Linear expansion coefficient: $(11 \pm 1) \cdot 10^{-6} / ^\circ\text{C}$.
- Operating temperature: 0 to 40°C.
- Cross-section: 21 x 25 mm.
- Total length =
 $L \leq 200 \text{ mm: } L + 104 \text{ mm,}$
 $L \leq 2200 \text{ mm: } L + 120 \text{ mm.}$
- Cable length: 3 m.
- Reference point in the center (standard).
- Protection: IP65.
- Power supply: $5 \pm 5\% \text{ Vdc, } 200 \text{ mA.}$

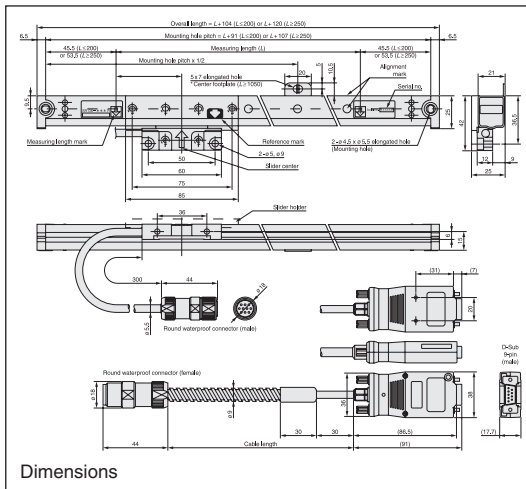

Item No.	Type	Measuring range/mm	Price EUR
346.800	GB-5ER	50	
346.801	GB-10ER	100	
346.802	GB-15ER	150	
346.803	GB-20ER	200	
346.804	GB-25ER	250	
346.805	GB-30ER	300	
346.806	GB-35ER	350	
346.807	GB-40ER	400	
346.808	GB-45ER	450	
346.809	GB-50ER	500	
346.810	GB-55ER	550	
346.811	GB-60ER	600	
346.812	GB-65ER	650	
346.813	GB-75ER	750	
346.814	GB-85ER	850	
346.815	GB-95ER	950	
346.816	GB-105ER	1050	
346.817	GB-125ER	1250	
346.818	GB-140ER	1400	
346.819	GB-160ER	1600	
346.820	GB-185ER	1850	
346.821	GB-205ER	2050	
346.822	GB-220ER	2200	

324.069 Turbine spray

For mounting kits refer to SJ700A.

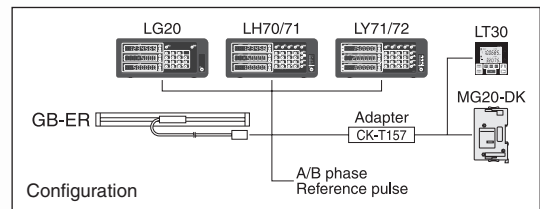

Item No.	Type	Length/m	Price EUR
Extension cables:			
346.260	CE10-01C	1	
346.261	CE10-03C	3	
346.262	CE10-05C	5	
346.263	CE10-10C	10	
346.867	Adapter cable CK-T157		
For connecting to old display types*:			
346.926	Adapter cable CE30		
346.448	Adapter SZ51-AB01		

* LG10, LH51/52, LH61 and LY51/52.
Both adapter cable and adapter are needed.

Magnescale Digiruler SL130 scale systems for a large measuring range

The Digiruler SL130 is very suitable as a low-priced long-axis scale, for example in combination with the SJ700A or GB-ER scales on the other axes. The scale is mounted with the self-adhesive back on a flat surface and protected by an aluminum (optionally stainless steel) cover.

- Measuring range: 0- 30 000 mm.
- Highest resolution: 0.01 mm.
- Accuracy at 20°C (L in m):
 $L \leq 7\,000\text{ mm: } \pm(25 + 5L)\ \mu\text{m,}$
 $L \leq 10\,000\text{ mm: } \pm(35 + 5L)\ \mu\text{m,}$
 $L \leq 20\,000\text{ mm: } \pm(45 + 5L)\ \mu\text{m,}$
 $L \leq 30\,000\text{ mm: } \pm(55 + 5L)\ \mu\text{m.}$
- The maximum allowed distance between reading head and scale is 1.5 mm.
- Max. measuring speed: 300 m/min.
- Total length = L + 100 mm.
- Protection: IP65 (PL25: IP67).

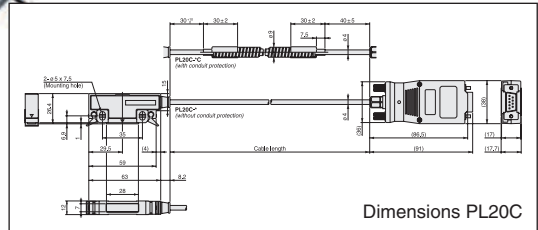
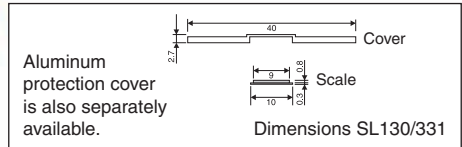
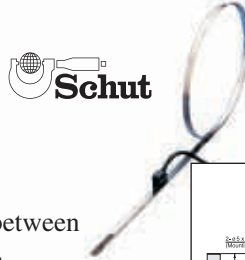

Item No.	Measuring range/mm	Price EUR
Digiruler SL130 scales:		
345.920	200	
345.921	300	
345.922	400	
345.923	500	
345.924	600	
345.925	700	
345.926	800	
345.928	1000	
345.930	1200	
345.933	1500	
345.936	1800	
345.938	2000	
345.948	3000	
345.958	4000	
345.968	5000	
345.978	6000	
345.988	7000	
345.998	8000	
346.008	9000	
346.018	10000	
346.028	20000	
346.038	30000	
344.922	Aluminum cover per meter, incl. bolts	

Item No.	Type	Length/m	Price EUR
PL20¹ without conduit protection:			
346.835	PL20C-3	3	
346.836	PL20C-5	5	
346.837	PL20C-10	10	
346.838	PL20C-15	15	
346.839	PL20C-20	20	
346.840	PL20C-30	30	
PL20¹ with stainless steel conduit protection:			
346.841	PL20C-3C	3	
346.842	PL20C-5C	5	
346.843	PL20C-10C	10	
346.844	PL20C-15C	15	
346.845	PL20C-20C	20	
346.130	PL25 ¹	3	
346.867	Adapter cable CK-T157		
For connecting to old display types²:			
346.926	Adapter cable CE30		
346.448	Adapter SZ51-AB01		

Other lengths available on request.

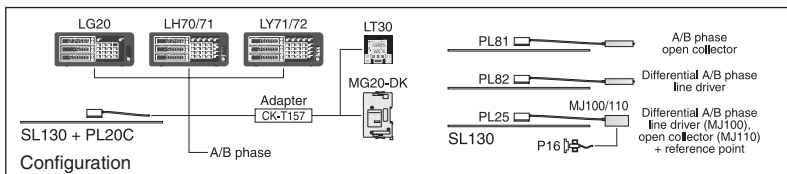

Magnescale Digiruler PL81/82 detectors (for SL130)

Magnescale detectors PL81/82 are used together with the SL130 scales.

- Highest resolution: 10 μm .
- Output PL81: A, B, alarm.
Output PL82: A, B, alarm,
A, B, alarm.
- Output PL81: open collector 50 V, 50 mA.
Output PL82: voltage differential line driver.
- Max. measuring speed: 300 m/min.
- Detector/cable unit: reading head, cable and detector.

- Clearance between scale and reading head: max. 1.5 mm.
- Protection reading head: IP67.
- Power supply:
PL81: 10-30 Vdc (2.1 W),
PL82: 5 Vdc (1.5 W).

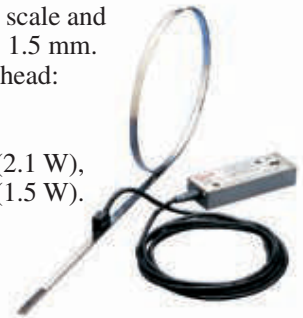

Item No.	Type	Cable length/m	Price EUR
346.380	PL81-3	3	
346.381	PL81-5	5	
346.382	PL81-7	7	
346.383	PL81-A	10	
346.384	PL81-B	15	
346.385	PL82-3	3	
346.386	PL82-5	5	
346.387	PL82-7	7	
346.388	PL82-A	10	
346.389	PL82-B	15	

Item No.	Type/description	Price EUR
Power supply (AC adapter):		
334.695	For PL81 (12 Vdc, 1 A)	
334.684	For PL82 (5 Vdc, 500 mA)	
Options:		
346.393	SZ11 protective guard for use in harsh environments	
346.397	SZ15 necessary mounting accessory for replacing the PL20 reading head by a PL81/82 reading head (with wiper)	

Magnescale Digiruler MJ100/110 detectors (for SL130/331)

The Digiruler detectors MJ100 and MJ110 can be used with the PL60 reading head and the SL331 scale for a highest resolution of 2 μm . The detectors can also be used with the PL25 reading head and the SL130 scale for a highest resolution of 5 μm . Accuracy as described for the SL scales. The maximum measuring speed depends on the pulse time (MJ100: 100 ns, MJ110: 1 μs) and the set resolution. Because of the short response time the detectors are very suitable for feedback applications.

- Input signal from reading head PL60 or PL25 and reference point (set P16).
- Output signal:
A/B phase, reference point and alarm.
- Power supply:
MJ100: 4.5- 6 Vdc,
MJ110: 11 -31 Vdc.

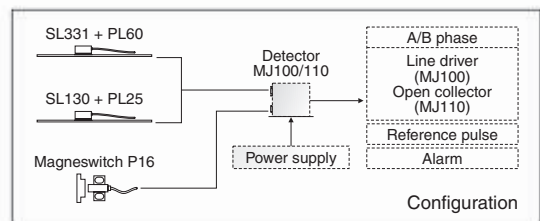

Item No.	Type/description	Price EUR
346.490	MJ100 (2 μm) (line driver, MC34C87)	
346.491	MJ110 (2 μm) (open collector)	
334.684	AC adapter MJ100 5 Vdc, 500 mA	
334.695	AC adapter MJ110 12 Vdc, 1 A	

Magnescale P15/16 reference point set for Digiruler and OEM

The set P16 consists of a magnet PG104 and reading head/detector PK16. The reading head has a red LED. Set P15 (reading head PK15) has an open-ended cable. Protection degree (IP67) makes these non-contact electronic switches long-lasting reliable components without the risk of wearing out.

- Measuring range: 7.5 ± 2 mm.
- Repeatability: 3 μ m.
- Dist. reading head - magnet: 1 mm (max. 3 mm).
- Output:
circuit: NPN transistor open collector,
contact capacity: max. 30 mA or 30 Vdc.
- Operating temperature: -10 to 60°C.
- Length reading head cable: 1.5 m.
- Dimensions reading head $l \times w \times h$:
28 x 30/8 x 10 mm.
- Power supply P15-1/P16-1: $5 \pm 10\%$ Vdc,
P15-2: $12 \pm 10\%$ Vdc,
P15-3: $24 \pm 10\%$ Vdc.

Item No.	Type	Price EUR
346.163	P15-1 / 5 V	
346.164	P15-2 / 12 V	
346.165	P15-3 / 24 V	
346.134	P16-1*	
Option:		
346.167	Wiper PZ3	

* With connector for detectors MJ100/110.



Extension cables for the P16-1

Item No.	Type	Length/m	Price EUR
346.141	CE09-03	3	
346.142	CE09-05	5	
346.143	CE09-010	10	
346.144	CE09-015	15	

Magnescale Digiruler SL331 scale systems for a large measuring range

The Digiruler SL331 scales feature a high resolution (from 2 μ m) and accuracy ($\pm (15 + 5L) \mu$ m, L in m), and have a very high measuring speed up to 720 m/min. Especially suitable for machine builders and OEMs. With the reading head/cable unit PL60 and detector MJ100 or MJ110, the SL331 is a favourable priced scale system with a maximum length of 8 m and an IP65 protection degree.

- Measuring range: 0 - 8000 mm (different lengths available).
- Highest resolution: 2 μ m.
- Accuracy: ($\pm (15 + 5L) \mu$ m, L in m).
- Max. measuring speed: 720 m/min.
- Protection: IP65.

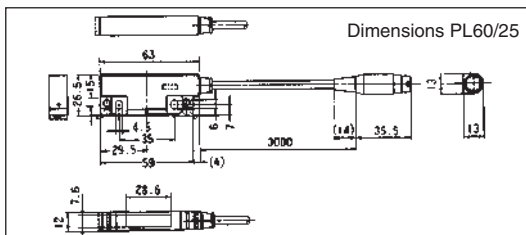

Dimensions PL60/25

Item No.	Type	Cable length/m	Price EUR
346.131	PL60	3	

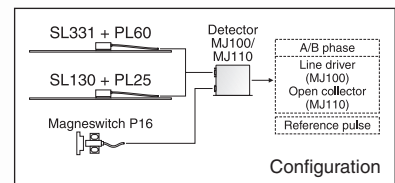

Extension cables

Item No.	Type	Length/m	Price EUR
346.136	CE08-1	1	
346.137	CE08-3	3	
346.138	CE08-5	5	
346.139	CE08-10	10	
346.140	CE08-15	15	

Magnescale SR118 scale systems with the world's smallest body

Scales with a very small body, designed for easy mounting on measuring applications, e.g. on the table of a measuring machine.

- Measuring range: 0- 260 mm.
- Highest resolution: 0.1 μm .
- Accuracy at 20°C:
 - $L \leq 60 \text{ mm}$: $\pm 2 \mu\text{m}$,
 - $L \leq 160 \text{ mm}$: $\pm 2.5 \mu\text{m}$,
 - $L \leq 260 \text{ mm}$: $\pm 3 \mu\text{m}$.
- Linear expansion coefficient: $(14 \pm 1) \cdot 10^{-6} / ^\circ\text{C}$.
- Operating temperature: 0 to 40°C.
- Cross-section: 7.5 x 8.2 mm.
- Total length =
 - $L \leq 60 \text{ mm}$: $L + 30 \text{ mm}$,
 - $L \leq 130 \text{ mm}$: $L + 40 \text{ mm}$,
 - $L \leq 260 \text{ mm}$: $L + 45 \text{ mm}$.
- Length reading head cable: 300 mm.
- Weight: from 40 g.

Item No.	Type	Measuring range/mm	Price EUR
Scales (excl. cable unit):			
346.400	SR118-015	15	
346.401	SR118-030	30	
346.402	SR118-060	60	
346.403	SR118-100	100	
346.404	SR118-130	130	
346.405	SR118-160	160	
346.406	SR118-210	210	
346.407	SR118-260	260	

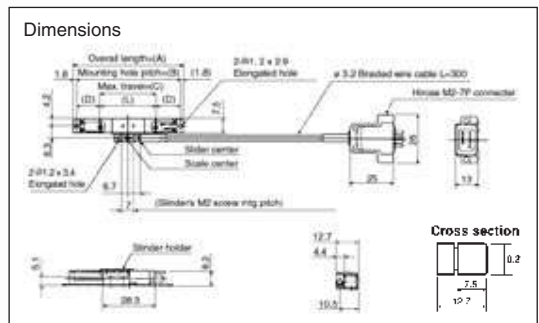

Item No.	Type	Length/m	Price EUR
Cable units for displays:			
346.293	CE05-03C	3	
346.294	CE05-05C	5	
346.445	Adapter SZ51-MS01		
346.793	Adapter SZ70-1		
346.867	Adapter cable CK-T157		
Cable unit for detectors:			
345.818	AK2-10C	10	

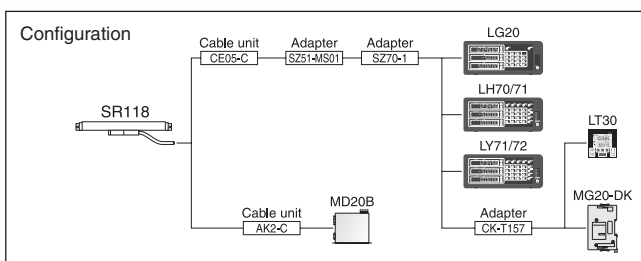

Magnescale SR-721SP scale systems for confined spaces

The SR-721SP is a real Magnescale, without housing. By fixing the reading head and displacing the scale through the reading head, the mounting size is minimal (for measuring microscopes, robotics and in cylinders).

- Measuring range: 0-475 mm.
- Highest resolution: 0.1 µm.
- Accuracy: ± 1 to 3 µm (depending on the measuring range), as specified on the laser measuring report.
- Linear expansion coefficient: $(14 \pm 1) \cdot 10^{-6} / ^\circ\text{C}$.
- Total length = $L + 100$ mm.
- Standard supplied with braided cable (1 m) and connector.
- Connecting cable unit has to be ordered separately.
- Dimensions reading head (without mounting plate): 14 x 16 x 40 mm.
- Measuring axis: $\varnothing 2$ mm.

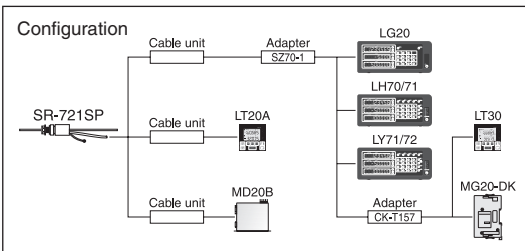
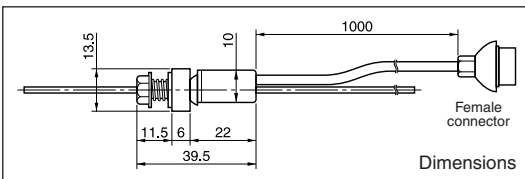

Item No.	Measuring range/mm	Price EUR
Magnescale SR-721SP scales:		
344.160	50	
344.161	75	
344.162	100	
344.163	125	
344.164	150	
344.165	175	
344.167	200	
344.168	225	
344.169	250	
344.170	275	
344.171	300	
344.172	325	
344.173	350	
344.140	375	
344.141	400	
344.142	425	
344.143	450	
344.144	475	

Item No.	To	Length/m	Price EUR
Standard cables:			
324.005	Displays ¹	3	
324.006	Displays ¹	5	
324.007	Displays ¹	10	
324.689	Display LT20	3	
324.695	Detectors ²	3	
324.696	Detectors ²	5	
324.697	Detectors ²	10	

Cables with stainless steel conduit protection:			
324.000	Displays ¹	3	
324.698	Displays ¹	5	
324.001	Displays ¹	10	
324.002	Detectors ²	3	
324.699	Detectors ²	5	
324.003	Detectors ²	10	

324.004	Extension cable (10 m) for all cables		
346.793	Adapter SZ70-1 ¹		
346.867	Adapter cable CK-T157 ¹		

¹ The displays LG20, LH70/71, LY71/72, LT30 and the counter module MG-DK.

² The detector MD20B.



Magnescale MD20B detector (for SR118 and SR-721SP)

Because not all Magnescale scales and gauges contain electronics, a detector is necessary as an interface to connect these sensors to the controls of a CNC system.

- Resolution: 0.1-0.2-0.5-1-2-2.5-4-5-10 μm .
- Output: A, B, Z, alarm, PCU, PCD,
A, B, Z, alarm, PCU, PCD.
- Dimensions: 171 x 144 x 32 mm.
- Power supply: 5 Vdc, 400 mA.
- Standard supplied with Honda output connector.



MD20B

Item No.	Type/description	Price EUR
344.884	Detector box MD20B	
430.115	Power supply, 94-264 Vac / 5 Vdc, 5 A*	
344.878	Connector set reference point PZ001	

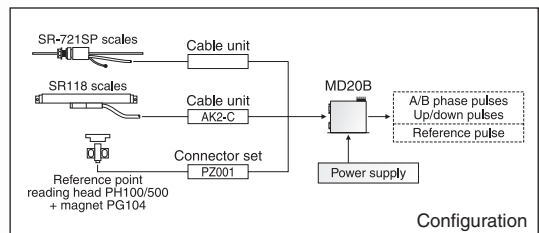

* To connect per power supply: 10 pcs. MD20B.

Magnescale PH100/500 reference point and set K2 for Magnescale and OEM

High accuracy reference points ($\pm 1 \mu\text{m}$) for use with a Magnescale detector MD20B. For use in combination with Magnescale or OEM (set K2). Set K2 consists of a reading head PH100, a magnet PG104 and a detector PD100, and has a digital as well as an analog output.

- Measuring range: $8 \pm 1 \text{ mm}$.
- Repeatability: $1 \mu\text{m}$.
- Distance reading head - magnet: 0.5 mm (max. 3 mm).
- Output pulse: +12 V, < 10 mA (12 k Ω).
- Voltage characteristics: 4.2 mVdc / $1 \mu\text{m}$ (distance reading head - magnet 0.5 mm).
- Operating temperature: -10 to 50°C .
- Length reading head cable: 3 m, max. length reading head cable: 30 m, max. length detector output cable: 20 m.
- Dimensions reading head $l \times w \times h$: 22 x 36 x 16 mm.
- Power supply: $12 \pm 10\%$ Vdc, 16.7 mA.

Item No.	Type/description	Cable length/m	Price EUR
344.624	Set K2	3	
344.635	Reading head PH100 (one direction)	3	
344.626	Reading head PH500 (two directions)	20	
344.625	Magnet PG104		



Magnescale SR series scale systems for CNC applications

These feedback scales boast superior speed and accuracy in addition to their high level of reliability under very harsh conditions, with a highest resolution of 10 nm. Available with output A/B phase or conform protocol (Mitsubishi/Yaskawa/Panasonic/Siemens DRIVE-CLiQ/Fanuc).



Magnescale Digiruler SL700 scales for a large measuring range

The SL700 series is a high-grade ribbon-type feedback system with a large measuring range and high accuracy for CNC applications. The non-contact, extremely reliable magnetic scales generate an analog, A/B phase or output signal according to a certain protocol.



Magnescale SmartSCALE scales

Magnescale SmartSCALE scales offer very high accuracy and a resolution up to 0.05 μm and are available with a range of output signals. The magnetic non-contact system is virtually insensitive for dirt.



Magnescale Laserscale scale systems

The Laserscale is a non-contact measuring system with the world's highest resolution of 0.0084 nm. Very high accuracy measurements of $\pm 0.03 \mu\text{m}$ can be realized. These Laserscales are typically not affected by changes in temperature, humidity and air pressure. Applications of the Magnescale Laserscale are for example measuring machines, electron microscopes, precision lathes and grinders, LCD inspection equipment and wafer inspection devices.



Magnescale Rolling Mill

Magnescale Rolling Mill is a feedback scale system used in rolling mills where metal is rolled into sheets and bars. Magnescale is a proven and reliable system, which is shock- and waterproof and resistant against high pressure.



Magnescale specials

Due to the slim design and resistance against harsh environments the Magnescale scales can be implemented in various systems and processes. The SR-721SP can for example be built into linear actuator cylinders.

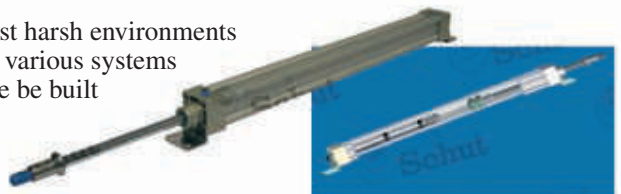

Magnescale DK805SB/812SB gauges

The Magnescale DK gauges are developed using the MR (magnetoresistance) sensor principle and have direct A/B phase output. The MR technology enables a 0.1 µm detection resolution. The gauges have a built-in reference point at 1 mm from the idle point of the spindle. Various models are available, e.g. with pneumatic push or vacuum retract.

- Measuring range: 5 or 12 mm.
- Resolution: 0.1 or 0.5 µm.
- Accuracy (p-p) at 20°C: resolution 0.1 µm: 1 µm,
resolution 0.5 µm: 1.5 µm.
- Max. measuring speed: resolution 0.1 µm: 42 m/min,
resolution 0.5 µm: 100 m/min.

Types with a higher measuring speed are available on request.

- Output: A/B phase and I3 Z (TTL line driver RS422).
- Cable length: 2.5 m (with extension cable: max. 22 m).
- Dimensions: ø8 x 79.6 mm (DK805SB) or ø8 x 105 mm (DK812SB).
- Measuring force at 20°C:
 - DK805SB: upward: 0.35 ± 0.25 N,
lateral: 0.4 ± 0.25 N,
downward: 0.45 ± 0.25 N,
 - DK812SB: upward: 0.4 ± 0.3 N,
lateral: 0.5 ± 0.3 N,
downward: 0.6 ± 0.3 N.

- Reference point.
- Clamping stem: ø8 mm.
- Protection: IP67.
- Resistant to oil, dirt, shocks and vibrations.
- Delivery incl. air fittings.
- Power supply: 5 ± 5% Vdc, 1 W.
- Also available with USB connection.

Type designation

DK8 05/12^① SB -/F^② -/L/V^③ R -/5^④

- ① Measuring range in mm.
- ② With (F) or without (-) flange.
- ③ Cable connection:
axial, with spring push (-),
radial, with vacuum retract (L), or
radial, with pneumatic push (V).
- ④ Resolution: 0.1 µm (-) or 0.5 µm (5).

Option for L types

Item No.	Description	Price EUR
344.465	Pneumatic retraction device DZ-801	



DK812SBLR
DK812SBR

NEW

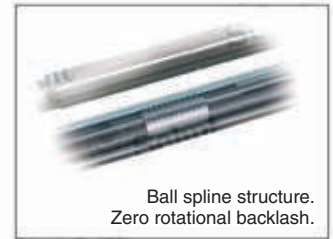

Ball spline structure.
Zero rotational backlash.

Item No.	Type	Price EUR
----------	------	-----------

Resolution 0.1 µm:

346.512	DK805SBR	
346.513	DK805SBLR	
346.514	DK805SBFR	
346.515	DK805SBFLR	
346.516	DK812SBR	
346.517	DK812SBLR	
346.518	DK812SBFR	
346.519	DK812SBFLR	
346.520	DK812SBVR	

Resolution 0.5 µm:

346.521	DK805SBR5	
346.522	DK805SBLR5	
346.523	DK805SBFR5	
346.524	DK805SBFLR5	
346.525	DK812SBR5	
346.526	DK812SBLR5	
346.527	DK812SBFR5	
346.528	DK812SBFLR5	
346.529	DK812SBVR5	

Magnescale DK830S gauges

The new DK830S series offers high accuracy with a measuring range of 30 mm in a compact design. The new developed ball spline bearing prevents spindle rotation and guarantees optimal performance with a lifetime of more than 30 million measuring cycles. The gauges have a built-in reference point at 1 mm from the idle point of the spindle. Various models are available, e.g. with pneumatic push or vacuum retract.

- Measuring range: 30 mm.
- Resolution: 0.1, 0.5 or 1 μm .
- Accuracy (p-p) at 20°C: 1.3 μm (DK830SR/SLR) or 1.7 μm (DK830SVR).
- Max. measuring speed: resolution 0.1 μm : 80 m/min,
resolution 0.5 μm : 100 m/min,
resolution 1 μm : 200 m/min.
- Output: A/B phase and reference point Z (TTL line driver RS422).
- Cable length: 2 m (with extension cable: max. 22 m).
- Dimensions: $\varnothing 8 \times 195.2$ mm (DK830SR),
 $\varnothing 8 \times 185$ mm (DK830SLR) or
 $\varnothing 8 \times 154$ mm (DK830SVR).
- Measuring force at 20°C:
DK830SR/SLR: upward: 0.5 ± 0.35 N,
lateral: 0.6 ± 0.35 N,
downward: 0.7 ± 0.35 N.
DK830SVR: at air pressure 0.07 MPa: ≤ 1.9 N,
at air pressure 0.09 MPa: ≤ 2.6 N.
- Reference point.
- Clamping stem: $\varnothing 8$ mm.
- Protection: IP67 (radial types; in combination with bellow), other types IP53.
- Resistant to oil, dirt, shocks and vibrations.
- Delivery incl. air fittings (V types).
- Power supply: $5 \pm 5\%$ Vdc, 1 W.
- A flange is separately available (DZ830F).



Type designation

DK830S -/L/V_① **R(B)** -/05/10_②

- ① Cable connection:
axial, with spring push (-),
radial, with vacuum retract (L), or
radial, with pneumatic push (V).
- ② Resolution: 0.1 μm (-), 0.5 μm (05)
or 1 μm (10).

Configuration Magnescale DK

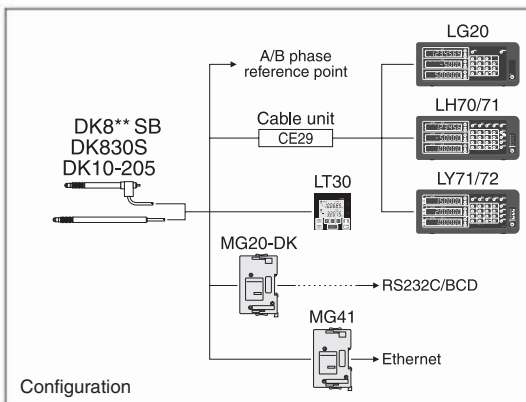

Item No.	Type	Price EUR
----------	------	-----------

Resolution 0.1 μm :

346.950	DK830SR	
346.951	DK830SLR	
346.952	DK830SVR	

Resolution 0.5 μm :

346.953	DK830SRB05	
346.954	DK830SLRB05	
346.955	DK830SVRB05	

Resolution 1 μm :

346.956	DK830SRB10	
346.957	DK830SLRB10	
346.958	DK830SVRB10	

Options:

346.959 ¹	Bellow set DZ830BL incl. air fittings	
346.960 ²	Bellow DZ830BV	
346.000	Flange DZ830F	

¹ For L types. ² For V types.

Magnescale DK10/25/50/100/155/205 gauges

The Magnescale DK gauges are developed using the MR (magnetoresistance) sensor principle and have direct A/B phase output. The gauges have a spring push and a built-in reference point at 1 mm (DK10-100) or not a spring push, and with a built-in reference point at 5 mm (DK155/205) from the idle point of the spindle.

- Measuring range: up to 205 mm.
- Resolution: 0.5 μm .
- Max. measuring speed: 250 m/min.
- Clamping stem: $\varnothing 20$ mm (DK155/205: $\varnothing 32$ mm).
- Output: A/B phase and reference point Z (TTL line driver RS422).
- Cable length: 2.5 m (with extension cable: max. 22 m).
- DK10-100: carbide ball tip $\varnothing 2.5$ mm.
DK155/205: flat magnet $\varnothing 22$ mm (10 N) with in the center a ball $\varnothing 4$ mm.
- Reference point.
- Operating temperature: 0 to 50°C.
- Protection: IP50 or IP64.
- Resistant to shocks and vibrations.
- Power supply: 5 $\pm 5\%$ Vdc, 1 W.



Type designation

DK 10/25/50/100/155/205_① N/P_② -L_③ R5

- ① Measuring range in mm.
② Protection: IP50 and with a reduced measuring force (N), or IP64 (P).
③ Cable connection: axial (-) or radial (L).

Item No.	Type	Accuracy p-p/ μm	Measuring force ¹ /N	Dimensions mm	Price EUR
346.853	DK10NR5	2	0.3/0.6/0.8	$\varnothing 20 \times 122$	
346.854	DK10PR5	2	≤ 4.9	$\varnothing 20 \times 122$	
346.855	DK10PLR5	2	≤ 4.9	$\varnothing 20 \times 102.5$	
346.857	DK25NR5	2	0.4/0.7/1	$\varnothing 20 \times 179.5$	
346.856	DK25NLR5	2	0.4/0.7/1	$\varnothing 20 \times 160$	
346.858	DK25PR5	2	≤ 4.9	$\varnothing 20 \times 179.5$	
346.859	DK25PLR5	2	≤ 4.9	$\varnothing 20 \times 160$	
346.860	DK50NR5	2	-/0.9/1.3	$\varnothing 20 \times 286$	
346.861	DK50PR5	2	6.2	$\varnothing 20 \times 286$	
346.862	DK100NR5	4	-/1.8/2.7	$\varnothing 25 \times 443.5$	
346.863	DK100PR5	4	9.3	$\varnothing 25 \times 443.5$	
346.864	DK155PR5	5	2.7	$\varnothing 32 \times 571$	
346.865	DK205PR5	6	2.7	$\varnothing 32 \times 721$	

¹ In case of reduced measuring force (N types): measuring force upward, lateral and downward, respectively.

Cables for Magnescale DK gauges

Item No.	Type	Length/m	Price EUR
Adapter cables:			
346.145	CE29-003	0.3	
346.146	CE29-01	1	
346.147	CE29-03	3	
346.148	CE29-05	5	
346.149	CE29-10	10	

Item No.	Type	Length/m	Price EUR
Extension cables:			
346.741	CK-T12	1	
346.742	CK-T13	3	
346.743	CK-T14	5	
346.744	CK-T15	10	
346.745	CE22-01 ²	1	
346.746	CE22-03 ²	3	
346.747	CE22-05 ²	5	
346.748	CE22-10 ²	10	

² Open end, TTL line driver RS422.



Magnescale DT gauges

These gauges are especially suitable for the built-in display LT10A (DT12/32) and LT11A (DT512). Together they form an economically favourable and very compact measuring system. The gauges DT512 are the same as the DT12 gauges, but have a resolution of 1 µm (in combination with the detector MT12 this is 5 µm).

- Measuring range: 12 mm or 32 mm.
- Highest resolution:
DT12/32: 5 µm, DT512: 1 µm.
- Accuracy:
DT12/32: ±5 µm, DT512: ±3 µm.
- Measuring force at 20°C:
DT12/512N: upward: 0.7±0.5 N,
lateral: 0.8±0.5 N,
downward: 0.9±0.5 N,
DT12/512P: ≤1.7 N,
DT32N/NV: upward: 1.1±0.8 N,
lateral: 1.3±0.8 N,
downward: 1.5±0.8 N,
DT32P: ≤2.9 N,
DT32PV: ≤9 N.
- Spring push, except DT32NV/PV:
pneumatic push.
- Cable length: 2 m.

- Dimensions *l x w x t* and weight (excl. cable unit):
DT12/512N: 116 x 35 x 12 mm, 75 g,
DT12/512P: 116 x 35 x 12 mm, 80 g,
DT32N/P: 218 x 35 x 12 mm, 120 g,
DT32NV/PV: 217.5 x 35 x 12 mm, 140 g.
- Protection DT12P/512P,
DT32P/PV: IP64.



Item No.	Type	Measuring range/mm	Price EUR
344.855	DT12N	12	
344.856	DT12P	12	
346.495	DT32N	32	
346.496	DT32P	32	
346.497	DT32NV	32	
346.498	DT32PV	32	
344.853	DT512N	12	
344.854	DT512P	12	
346.477	Adapter DZ51		
346.793	Adapter SZ70-1		
344.426*	Pneumatic retraction device DZ176		

* Only for the DT12 and DT512 gauges.

Item No.	Type	Length/m	Price EUR
Extension cables:			
346.136	CE08-1	1	
346.137	CE08-3	3	
346.138	CE08-5	5	
346.139	CE08-10	10	
346.140	CE08-15	15	

Item No.	Type	Resolution µm	Price EUR
To LG20, LH70/71, LY71/72, LT20A:			
346.851	MT12-05	5	
346.871	MT12-10	10	
To LT30:			
346.872	MT13-01	1	
346.852	MT13-05	5	
346.873	MT13-10	10	
A/B phase (TTL line driver RS422):			
346.874	MT14-01	1	
346.875	MT14-05	5	
346.876	MT14-10	10	
334.684 AC adapter for MT14			
To MF10:			
346.412	MT20-01	1	
346.413	MT20-05	5	

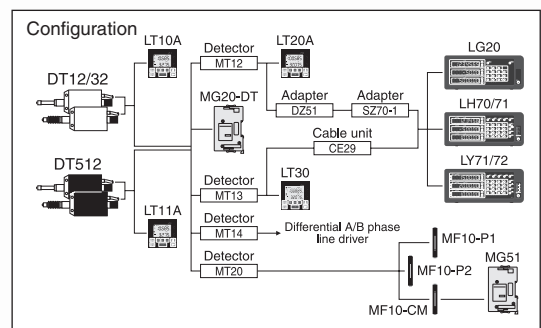

Magnescale DF805S/812S gauges

The new robust DF probes combine a high resolution with a compact body. These probes are specifically designed for use with the MF10 counter modules.

- Measuring range: 5 or 12 mm.
- Resolution: 0.1 μm .
- Accuracy at 20°C: 1 μm .
- Max. measuring speed: 80 m/min.
- Cable length: 2 m (with extension cable: max. 20 m).
- Dimensions: $\varnothing 8 \times 82.8$ mm (DF805SR) or $\varnothing 8 \times 109.7$ mm (DF812SR).
- Measuring force at 20°C:
 - DF805SR: upward: 0.35 ± 0.25 N,
lateral: 0.4 ± 0.25 N,
downward: 0.45 ± 0.25 N,
 - DF812SR: upward: 0.4 ± 0.3 N,
lateral: 0.5 ± 0.3 N,
downward: 0.6 ± 0.3 N.
- Built-in reference point at 1 mm from the idle point of the spindle.
- Clamping stem: $\varnothing 8$ mm.
- Protection: IP67.
- Resistant to oil, dirt, shocks and vibrations.
- Delivery incl. air fittings.
- Power supply: $5 \pm 5\%$ Vdc, 1 W.



Item No.	Type	Price EUR
346.540	DF805SR	
346.541	DF805SLR	
346.542	DF805SFR	
346.543	DF805SFLR	
346.544	DF812SR	
346.545	DF812SLR	
346.546	DF812SFR	
346.547	DF812SFLR	

Type designation

DF8 05/12 ① **S** -/F₂ -/L₃ **R**

- ① Measuring range in mm.
- ② With (F) or without (-) flange.
- ③ Cable connection:
axial, with spring push (-),
radial, with vacuum retract (L).

Item No.	Type	Length/m	Price EUR
Extension cables:			
346.548	CE34-005	0.5	
346.549	CE34-02	2	
346.550	CE34-05	5	
346.551	CE34-10	10	
346.552	CE34-15	15	
346.553	CE34-20	20	

Magnescale MF10 Digital Tolerance Indicator

The MF10 counter module is suitable for the DF and DT probes. The module has a clear display and can also generate Go/NoGo output.

- I/O circuit:
 - MF10-P1: NPN output (current sink),
 - MF10-P2: PNP output (current source).
- Minimum display unit: 0.1 μm .
- Highly visible white LED.
- Number of external inputs: 1.
- Preset.
- Tolerance setting.
- Output inversion function.
- Go/NoGo tolerance evaluation.
- Number of Go/NoGo judgement output: 2.
- Dimensions $l \times w \times t$ and weight (excl. cable unit):
83.4 x 33.5 x 10 mm, 75 g.
- Cable length: 2 m.
- Operating temperature: 0 to 55°C.
- Power supply: 10-30 Vdc.

Item No.	Type/description	Price EUR
346.414	MF10-P1 NPN output	
346.415	MF10-P2 PNP output	



Magnescale MG modular multi-interface system

The MG series is a modular gauging system designed to be incorporated into assembly lines and inspection equipment. Different MG modules are available for connecting gauges of the Magnescale DK, DT and MF series.

The MG10/20/30 interfaces are connectable via RS232C or BCD. Gauges are connected to the MG20 modules. Up to 16 MG20 modules can be connected to one MG10 base module. The MG10 module can itself be linked to three other MG10 modules, which enables output of measuring data of up to 64 gauges through one RS232C port, or BCD via an additional MG30.

The MG40-series ethernet interface series is developed for the Magnescale DK gauges. Up to 100 channels can be connected to the MG41. The MG41 itself has a direct connection possibility for 4 DK gauges and can be expanded with MG42 extension modules with the connection possibility of 4 gauges each.

The MG50 is a new EtherCAT / CC-link interface compatible with the Magnescale DT and DF probes. With one probe per MF10-CM up to 10 probes can be connected to one MG51, and up to 8 MG51's can be connected to one MG50. A maximum total number of 16 (CC-Link) or 30 (EtherCAT) probes can be connected to one MG50. The MG50 is PLC programmable and Fieldbus compatible.

- Input resolutions:
0.1 μm , 0.5 μm , 1 μm , 5 μm and 10 μm .
- Preset/reset/recall.
- Hold functions for when the workpiece is changed.
- Min/max/P-P function.
- Go/NoGo tolerance evaluation.
- Alarm function.
- Reference point: if present on the gauge.
- Operating temperature: 0 to 50°C.
- Power supply: 12 - 24 Vdc.



MG30+MG10+6xMG20

MG10/20/30

Item No.	Type/description	Price EUR
Base modules with RS232C communication:		
346.734	MG10-P1, output: -com	
346.735	MG10-P2, output: +com	
Counter modules:		
346.736	MG20-DT, for DT	
346.738	MG20-DK, for DK	
Interface modules:		
346.739	MG30-B1, output: -com	
346.740	MG30-B2, output: +com	
Options:		
430.182	AC adapter 12 Vdc, 60 W	
348.122	RS232C cable DZ252 (2 m, connector 9-pin Sub-D)	
495.208	RS232C-USB adapter	
346.486	RS232C cable LZ61 for linking two MG10s	
346.867	Adapter cable CK-T157	

NEW

MG70/MG71

PLC fieldbus coupler for Magnescale DK series and DT series gauges. Probedata can be transferred to a PLC via EtherNet/IP (MG70-EI) or PROFINET (MG70PN). One MG71 is required per probe, a maximum of 85 MG71's can be connected to one MG70.

- Resolution depending on connected probes.
- Data transfer speed:
via EtherNet/IP 10/100 Mbps,
via PROFINET RT 100 Mbps.
- Suitable for 35 mm DIN rail mounting.
- Power supply: 20.4 - 28.8 Vdc.

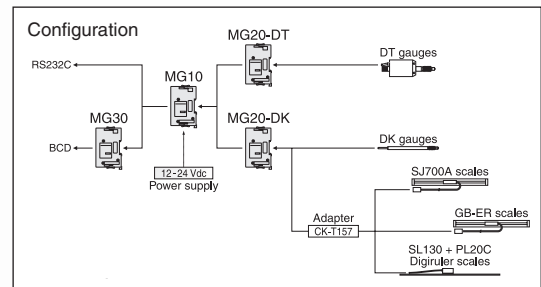

Magnescale MG modular multi-interface system (continued)



MG41 + MG42

Configuration

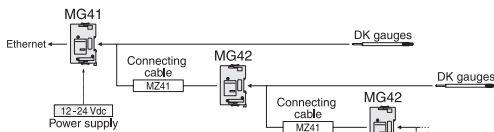

MG50 + 7xMF10

Configuration

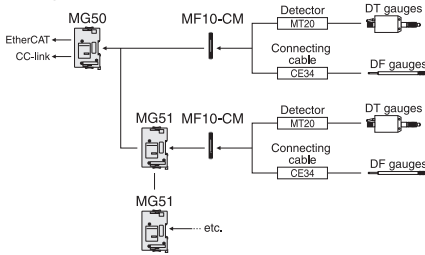

MG70/71

NEW

MG40 series

Item No.	Type/description	Price EUR
Base module with Ethernet communication:		
346.879	MG41-NE	
Extension module:		
346.880	MG42-4	
Connecting cables:		
346.881	MZ41-R5 (0.5 m)	
346.882	MZ41-01 (1 m)	
346.883	MZ41-02 (2 m)	
346.884	MZ41-05 (5 m)	
346.885	MZ41-10 (10 m)	
Option:		
430.182	AC adapter 12 Vdc, 60 W	



MG50 series

Item No.	Type/description	Price EUR
Base module with EtherCAT interface:		
346.408	MG50-EC	
Base module with CC-link interface:		
346.409	MG50-CL	
Extension module:		
346.410	MG51	
Counter module:		
346.411	MF10-CM	

Configuration

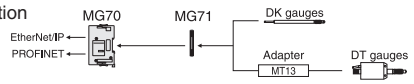

MG70/71 series

Item No.	Type/description	Price EUR
346.074	MG70-EI EtherNet/IP	
346.075	MG70-PN PROFINET	
346.076	MG71-CM	

Retraction device DZ801

Pneumatic retraction device for the L type of the DK805/812 gauges.



Item No.	Type	Price EUR
344.465	DZ801	

Retraction devices DZ174

These pneumatic retraction devices are made for (DK) gauges with a clamping stem of $\varnothing 20$ mm. Working pressure: 30 - 50 N/cm².



Item No.	Type	For	Price EUR
344.416	DZ174-010	DK10	
344.417	DZ174-025	DK25	
344.418	DZ174-050	DK50	

Retraction device DZ176

Retraction device for pneumatic push of the DT12 and DT512 gauges.

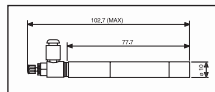

Item No.	Type	For	Price EUR
344.426	DZ176	DT12/512	

Probe accessories



DZ210



DZ811

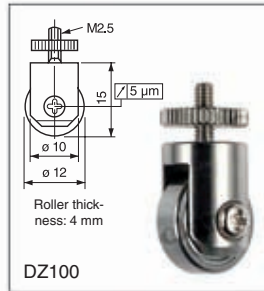

DZ100



DZ181



DZ5100



DZ170

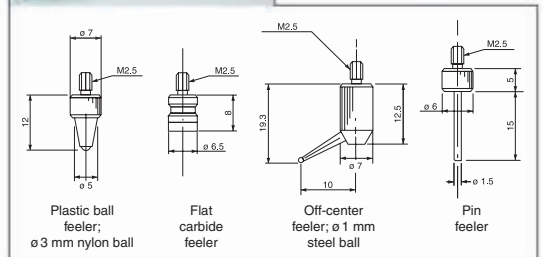

Plastic ball feeler; $\varnothing 3$ mm nylon ball

Flat carbide feeler

Off-center feeler; $\varnothing 1$ mm steel ball

Pin feeler

Item No.	Type/description	Price EUR
----------	------------------	-----------

344.406	DZ210 Gauging bracket $\varnothing 20$ mm	
344.470	DZ811 Adapting bush $\varnothing 20 - \varnothing 8$ mm	
346.870	DZ161 Retraction lever bottom mounted with M2.5 thread	
344.408	DZ170 Retraction device $\varnothing 20$ mm with lever	
344.402	DZ100 Roller feeler	
344.715	DZ181 Magnetic contact point $\varnothing 22$ mm for DK155/205	
344.409	DZ5100 Set of 4 probes	

Magnescale LG20 and LH70/71 display units

These Magnescale display units, for 1, 2 or 3 axes, are well readable, easy to operate and equipped with many functions. The high-end LH71 has even more functions.

- For 1, 2 or 3 axes.
- Highest resolution: SJ700A: 5 μm , GB-ER: 0.5 μm , PL20C (Digiruler): 10 μm , SR118: 0.5 μm , SR-721SP: 0.5 μm , DK802/812: 0.1 μm , DK10-205: 0.5 μm , DT12/32/512: 5 μm .
- mm/inch conversion.
- Display: 7 digits, orange LED display and floating minus sign.
- Reset: resettable at any point on the scale.
- Preset: up to 3 values per axis.
- Recall: recall data stored by preset.
- Input: A/B phase (according EIA/RS422).
- Alarm signal for temporary power failure, exceeded max. measuring speed, error in stored data, disconnected scale or gauge and display overflow.
- Operating temperature: 0 to 40°C (with no condensation).
- Memory for the latest value and preset values at power loss.
- Diameter read-out.
- Linear error compensation: LG20 max. $\pm 600 \mu\text{m/m}$, LH70/71 max. $\pm 1000 \mu\text{m/m}$.
- Energy saving function.
- Power supply: 12 Vdc or 100-240 Vac (when using AC adapter).
- Power consumption: max. 32 VA.
- Dimensions: 289 x 123 x 80 mm.
- Weight: approx. 1.5 kg.

LH70/71 only:

- ABS/INC switchable. In the ABS mode the distance to the reference point is displayed.
- Midpoint calculation for centering purposes.
- Canned cycle functions (2-axes and 3-axes models): bolt hole circle function, line hole function (LH71 only), radius function for angles.
- Hold function: hold of display value and set as a tool offset value.
- Tool offset memory (3-axes models only): LH70: 12 values, LH71: 99 values.
- Addition function for two selectable axes: $\pm Z1 \pm Z2$ (3-axes models only).

- Reference point detection for scales with a fixed reference point.
- Reference point memory: LH70: 10 reference points, LH71: 150 reference points.



LH71 only:

- Read-out of arcs, highest resolution: 1" (Digiruler only).
- Segmented error compensation: max. $\pm 600 \mu\text{m/m}$, up to 32 sections (requires scale with reference point).
- Scaling function: display value = actual movement distance x scaling value 0.100000-9.999999.
- Program function:
 - 1) by manual input,
 - 2) by data storage while functioning (teach-in);
 - 3) by using mirror image function while running the program;
 - 4) by inserting canned cycle functions.



Item No.	Type/description	Price EUR
346.846	LG20-1 / 1 axis	
346.847	LG20-2 / 2 axes	
346.848	LG20-3 / 3 axes	
346.774	LH70-1 / 1 axis	
346.775	LH70-2 / 2 axes	
346.776	LH70-3 / 3 axes	
346.777	LH71-1 / 1 axis	
346.778	LH71-2 / 2 axes	
346.779	LH71-3 / 3 axes	
346.866	LH71-A3T01 / 3 axes	
346.780	AC adapter 12 Vdc, 3 A	

Magnescale LG20 and LH70/71 display units (continued)

■ Front

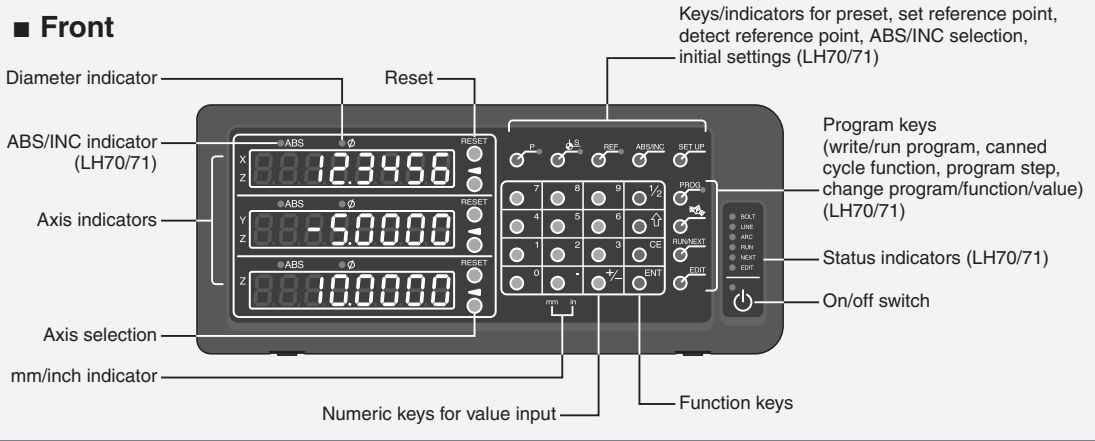

■ Dimensions

Size in mm

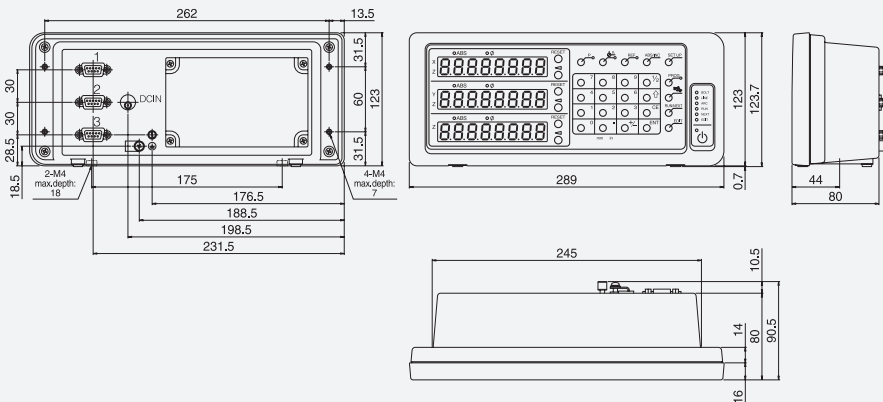

■ Configuration

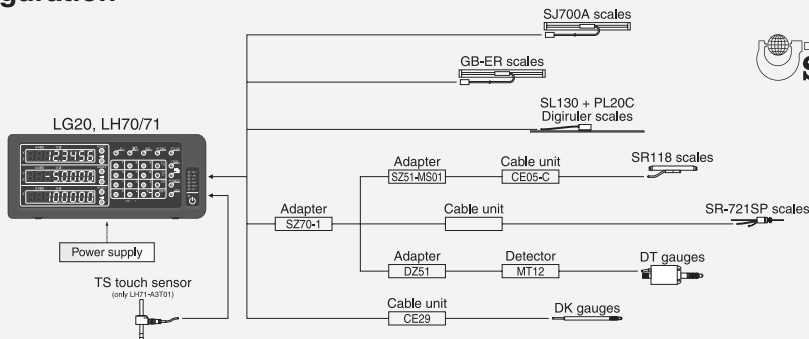

Magnescale LT10A/11A display units

Very compact display unit that, because of its small size, is suitable for inclusion into systems. Display unit with one or two DT12/32 (LT10A) or DT512 (LT11A) measuring gauge connections and several functions and output signals.

- Highest resolution:
 - 5 μm (LT10A) or 1 μm (LT11A).
- Illuminated LCD display with 5 digits and floating minus sign.
- Output: BCD (type B), RS232C (type C).
- Reset/preset.
- Min/max/P-P function, recall function.
- Addition function: $\pm A \pm B$ (2-axes models).
- Comparator values for Go/NoGo indication and output signals (open collector). The BCD models have 4 different preset selections.
- Max. measuring speed: 60 m/min.
- Dimensions: 72 x 72 x 80 mm.
- Weight: 200-270 g.
- Power supply:
 - 12-24 Vdc via terminals,
 - 12 Vdc via AC adapter and plug, directly or via stand-alone housing.

Item No.	Type/description	Price EUR
Display unit for 1 measuring gauge:		
344.857	LT10A-105	
344.858	LT10A-105B (BCD)	
344.859	LT10A-105C (RS232C)	
344.863	LT11A-101	
344.864	LT11A-101B (BCD)	
344.865	LT11A-101C (RS232C)	
Display unit for 2 measuring gauges:		
344.860	LT10A-205	
344.861	LT10A-205B (BCD)	
344.862	LT10A-205C (RS232C)	
344.866	LT11A-201	
344.867	LT11A-201B (BCD)	
344.868	LT11A-201C (RS232C)	
334.695	Mini AC adapter 12 Vdc, 1 A	
Options:		
348.276	Stand-alone housing with on/off switch	
348.122	RS232C cable for PC connection (D sub 9 pin)	

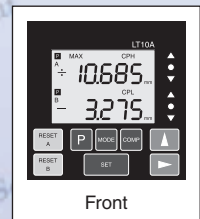
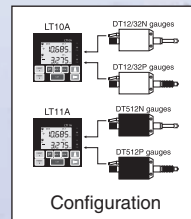

Magnescale LT20A/30 display units

Very compact display unit that, because of its small size, is suitable for inclusion into systems. Can be used for many Magnescale scales and gauges.

- Highest resolution:
0.5 μm (LT20A) or 0.1 μm (LT30).
- Display: backlight LCD display with 6 digits, floating minus sign and mode indication.
- Measuring mode setting by key switch or external signal.
- Input: A/B phase (10p DIN plug).
Output: BCD (type B), RS232C (type C).
- Terminal connection:
Input: reset, peak-hold start, preset, recall.
Output: Go/NoGo.
- Reference point detection (only LT30).
- Alarm signals.
- Data storage of: resolution, measuring direction, preset value, tolerance limits, measuring mode, BCD logic (positive/negative) and RS232C communication parameters.
- Reset/preset/recall.
- Min/max/P-P function.
- Addition function: $\pm A \pm B$ (2-axes models).
- Comparator values for Go/NoGo indication and output signals (open collector). The BCD models have 4 different preset selections.
- Dimensions: LT20A: 72 x 72 x 104.5 mm,
LT30: 72 x 72 x 71.8 mm.
- Weight: 200 - 270 g.
- Power supply: 12 - 24 Vdc (max. 9 W).

Item No.	Type/description	Price EUR
Display unit for 1 measuring gauge:		
346.460	LT20A-101	
346.461	LT20A-101B (BCD)	
346.462	LT20A-101C (RS232C)	
346.787	LT30-1G	
346.788	LT30-1GB (BCD)	
346.789	LT30-1GC (RS232C)	
Display unit for 2 measuring gauges:		
346.463	LT20A-201	
346.464	LT20A-201B (BCD)	
346.465	LT20A-201C (RS232C)	
346.790	LT30-2G	
346.791	LT30-2GB (BCD)	
346.792	LT30-2GC (RS232C)	
334.695	Mini AC adapter 12 Vdc, 1 A	
Options:		
348.276	Stand-alone housing with on/off switch	
348.122	RS232C cable for PC connection (D sub 9 pin)	

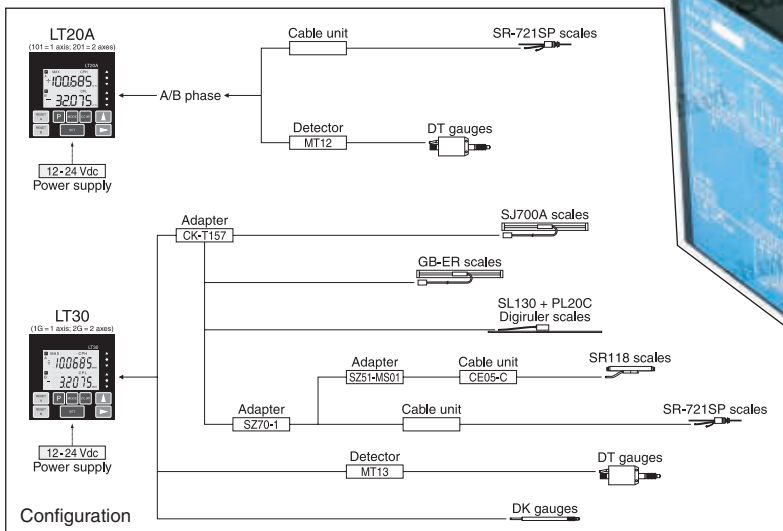

Magnescale LY71/72 display units

Multifunctional display units of which the LY71 is expandable with optional replaceable expansion boards and the LY72 is equipped with an RS232C interface and programmable I/O connector.

- Highest resolution: SJ700A: 5 μm , GB-ER: 0.5 μm , PL20C (Digiruler): 10 μm , SR118: 0.5 μm , SR-721SP: 0.5 μm , DK802/812: 0.1 μm , DK10-205: 0.5 μm , DT12/32/512: 5 μm .
- mm/inch conversion.
- ABS/INC switchable. In the ABS mode the distance to the reference point is displayed.
- Display: 7 digits, orange LED display and floating minus sign.
- Display data: current/min/max/P-P values (LY72 applications with scale: only current).
- Preset/reset/restart.
- Input: A/B phase (according EIA/RS422).
- Alarm signal for temporary power failure, exceeded max. measuring speed, error in stored data, disconnected scale or gauge and display overflow.
- Operating temperature: 0 to 40°C (with no condensation).
- Memory for the latest value and preset values at power loss.
- Two hold functions: hold of display value (while latched) and peak calculation hold (while paused). LY72 applications with scale: only hold of display value.
- Peak hold function convenient for statistical measurement.
- External input functions for automatic measurement.
- Scaling function: display value = actual movement distance x scaling value 0.100000 - 9.999999.
- Linear error compensation: max. $\pm 1000 \mu\text{m/m}$.

- Power supply: 12 Vdc or 100-240 Vac (when using AC adapter).
- Power consumption: max. 32 VA.
- Dimensions: 289 x 123 x 80 mm.
- Weight: approx. 1.5 kg.

LY71 only:

- Input for 1 or 2 axes.
- Addition function.
- Optional expansion boards.

LY72 only:

- Up to 3 axes can be connected.
- RS232C data output.

Item No.	Type/description	Price EUR
346.849	LY71	
346.850	LY72	
346.780	AC adapter 12 Vdc, 3 A	
Options LY71:		
346.868	BCD-I/O board LZ71-B	
346.869	Comparator I/O open collector/relay LZ71-KR	
Options LY72:		
495.169	RS232C cable for PC connection (D sub 9 pin)	
264.504	Mitutoyo DP-1VR SPC printer ¹	
348.042	RS232C→Mitutoyo interface ²	
900.825	Printing paper (5 rolls)	

¹ Incl. AC adapter (6 Vdc) and a roll of printing paper.

² Makes e.g. the Magnescale signal suitable for the SPC printer (495.169 required).

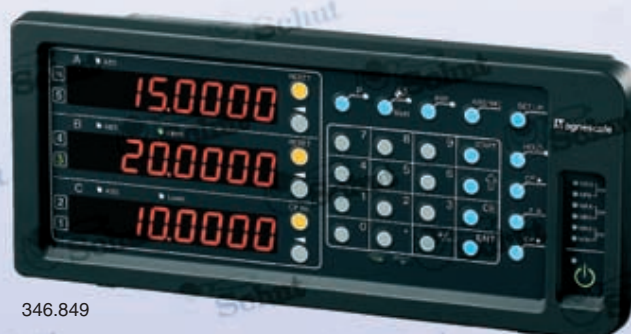

346.849

Magnescale LY71/72 display units (continued)

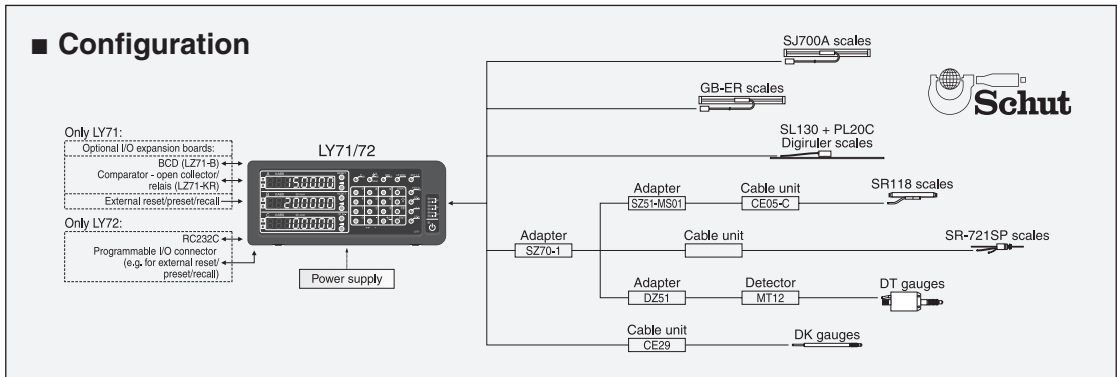
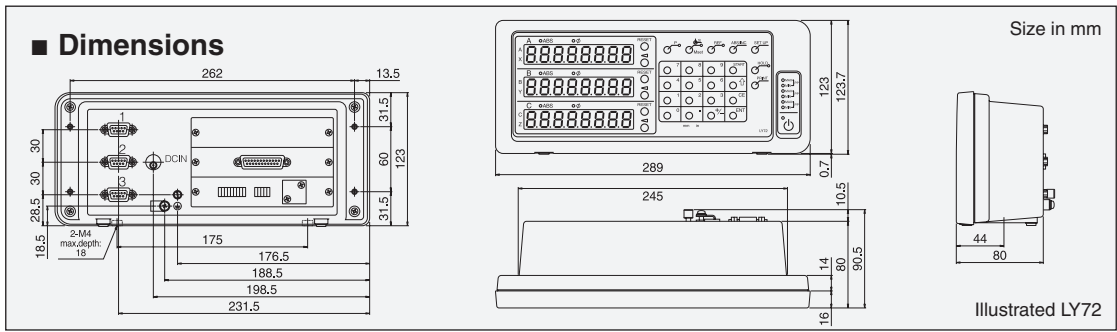
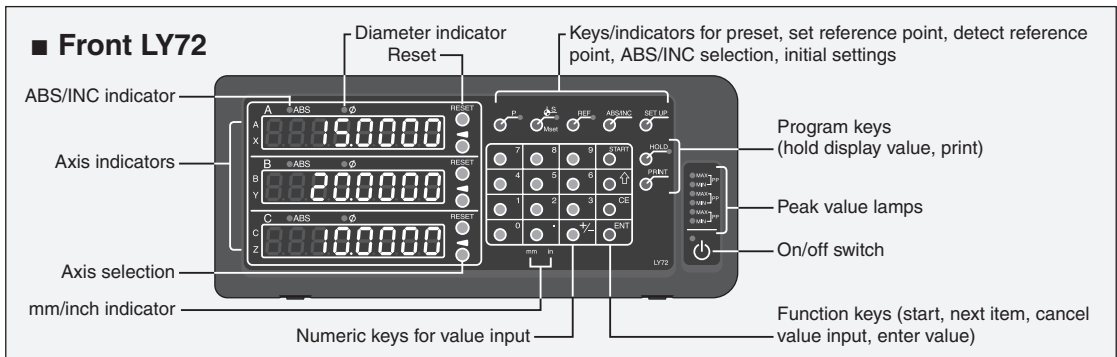
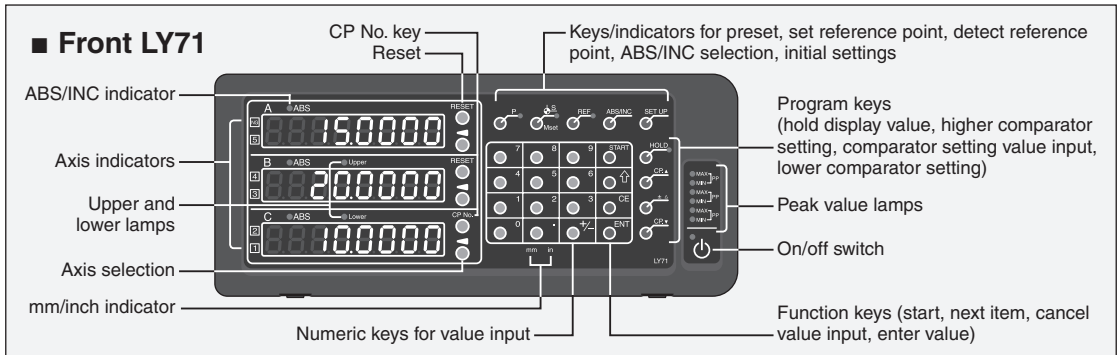

Magnescale TS touch sensor

The touch sensor is in fact a switch that reacts on the galvanic contact of the spring-mounted probe ball with the workpiece. Therefore the workpiece has to be electroconductive.

When the sensor is connected to a suitable display, the display can stop or show a preset value when the sensor makes contact.

- Clamping stem: \varnothing 10 mm.
- Probe ball: \varnothing 10 mm.

Touch sensor without cable

Item No.	Type	Clamping stem \varnothing /mm	Price EUR
344.400	TS-1	10	

Cable for touch sensor

Item No.	Type	Length/m	Price EUR
346.304	LZ40-03	3	
346.305	LZ40-05	5	
346.306	LZ40-10	10	



Schut

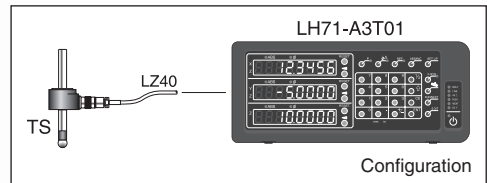

Display supports KB/KBU

Display supports with a steel plate tray which is rotatable over its length axis. The solid wall mount support with hinge joint KBU is vertically adjustable.

- Dimensions tray: 73 x 200 mm.
- Height KB: 130 mm.
- Arm length KBU: 400 mm.
- Mounting materials included.

Item No.	Type/description	Price EUR
857.801	Display support KB	
857.800	Display support KBU	
857.803	Mounting kit* for lathes, incl. display support KB	
857.804	Mounting kit* for milling machines, incl. display support KBU	

* For mounting kits refer to SJ700A.



Calipers / Depth calipers and micrometers

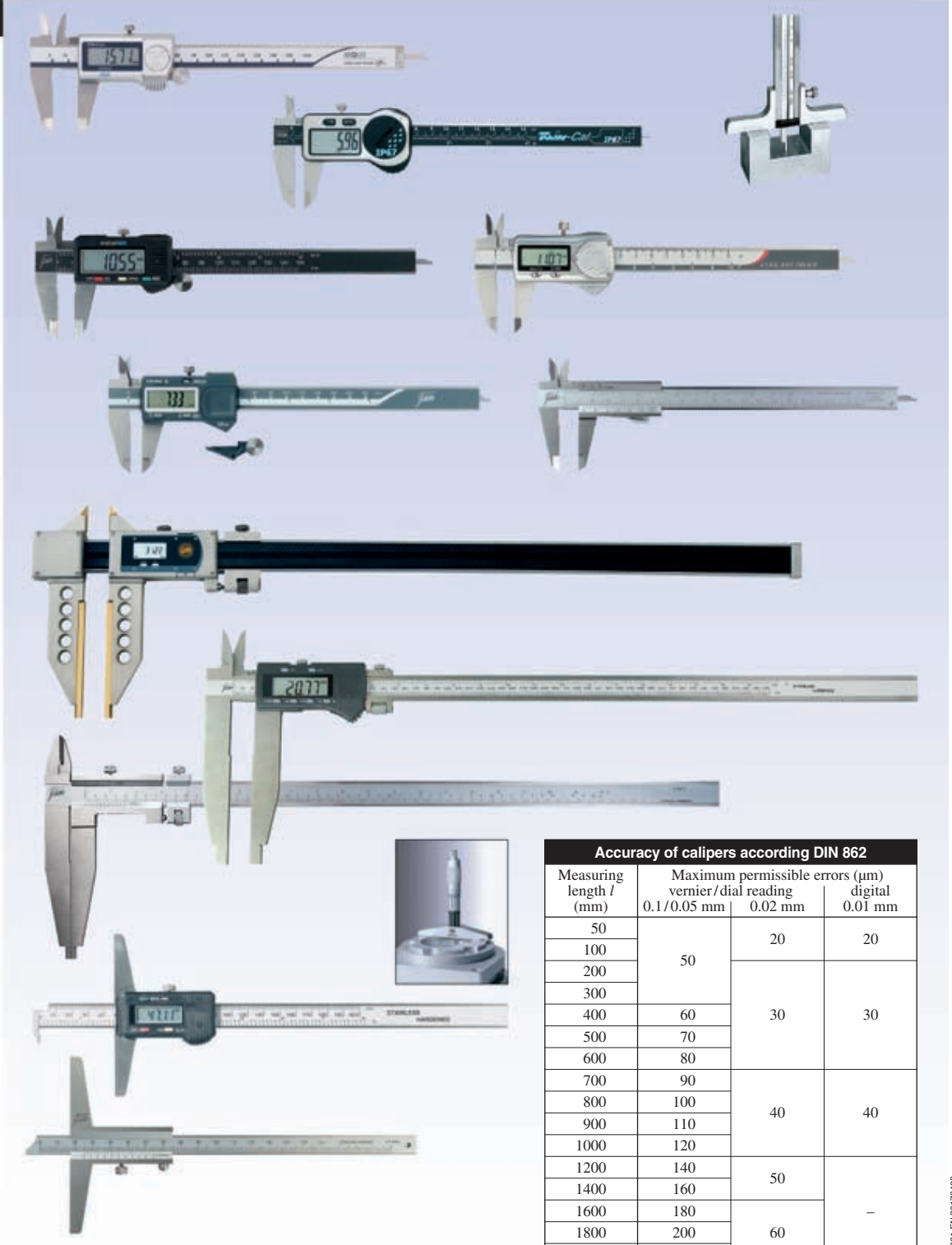

Measuring length <i>l</i> (mm)	Accuracy of calipers according DIN 862		
	Maximum permissible errors (µm) vernier/dial reading		digital
	0.1/0.05 mm	0.02 mm	0.01 mm
50	50	20	20
100			
200		30	30
300			
400	60	40	40
500	70		
600	80		
700	90		
800	100	50	-
900	110		
1000	120		
1200	140		
1400	160	60	-
1600	180		
1800	200		
2000	220		

Absolute digital calipers

Calipers with an absolute measuring system. This gives you the advantage that the caliper stores the one-time setting of the absolute zero position until the battery has to be changed. This reduces the chance of measuring errors and enables you to use the caliper without zero setting.

- Measuring range: 0-300 mm.
- Resolution: 0.01 mm.
- mm/inch conversion.
- ABS/INC switchable.
- Digit height: 11 mm.
- On/off switch.
- Max. measuring speed: 1.5 m/s.
- Locking screw.
- Power supply: 1 battery type V357.

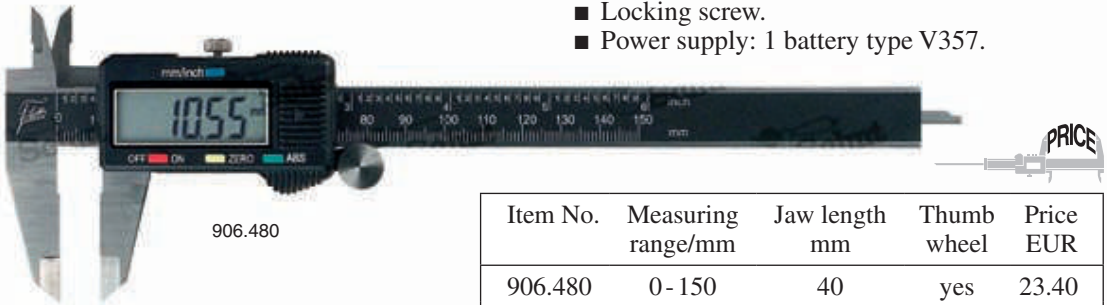

906.480

Item No.	Measuring range/mm	Jaw length mm	Thumb wheel	Price EUR
906.480	0-150	40	yes	23.40
906.481	0-200	50	yes	32.90
906.482	0-300	60	yes	59.00
Option: 836.535 Spare battery				1.90

Digital calipers with excellent price-performance ratio

- Measuring range: 0-300 mm.
- Resolution: 0.01 mm.
- mm/inch conversion.
- On/off switch.
- Digit height:
measuring range ≤ 100 mm: 8 mm,
measuring range ≥ 150 mm: 11 mm.
- Reset.
- Locking screw.
- Power supply: 1 battery type V357.

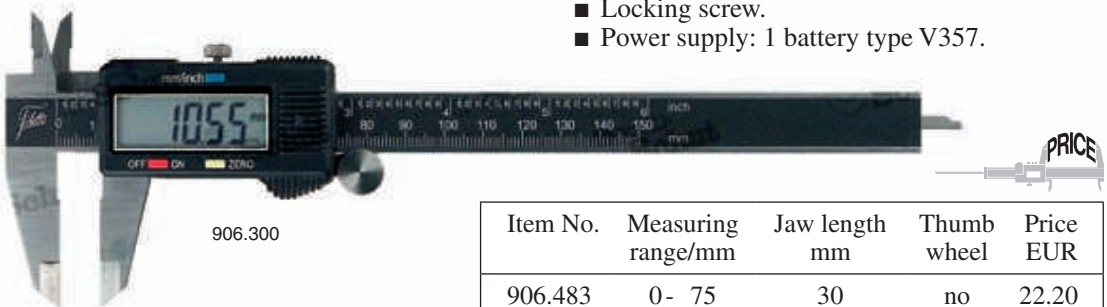

906.300

Item No.	Measuring range/mm	Jaw length mm	Thumb wheel	Price EUR
906.483	0-75	30	no	22.20
906.484	0-100	30	no	21.80
906.300	0-150	40	yes	22.10
906.302	0-200	50	yes	32.10
906.304	0-300	60	yes	57.00
Left-handed model: 906.299 0-150 40 yes				54.00
Option: 836.535 Spare battery				1.90



Absolute digital calipers

The advantage of these calipers is the one-time setting of the absolute zero position until the battery has to be changed. This reduces the chance of measuring errors and enables you to use the calipers without zero setting.

- Measuring range: 0-300 mm.
- Resolution: 0.01 mm.
- mm/inch conversion.
- ABS/INC switchable.
- Digit height: 10 mm.
- On/off switch.
- Reset.
- Max. measuring speed: 1.5 m/s.
- DIN 862.
- Delivery with an inspection report.
- Power supply: 1 battery type V357.



907.546

Item No.	Measuring range/mm	Jaw length mm	Price EUR
907.546	0-150	40	34.30
907.547	0-200	50	53.00
907.548	0-300	60	87.00
Option:			
836.535	Spare battery		1.90

Digital calipers

The advantage of these calipers is the one-time setting of the absolute zero position until the battery has to be changed. This reduces the chance of measuring errors and enables you to use the calipers without zero setting.

- Measuring range: 0-300 mm.
- Resolution: 0.01 mm.
- mm/inch conversion.
- Digit height: 10 mm.
- On/reset switch.
- Max. measuring speed: 1.5 m/s.
- DIN 862.
- Delivery with an inspection report.
- Power supply: 1 battery type V357.



907.537

Item No.	Measuring range/mm	Jaw length mm	Price EUR
907.537	0-150	40	32.60
907.538	0-200	50	51.00
907.539	0-300	60	85.00
Option:			
836.535	Spare battery		1.90



Digital calipers with hold function

Digital calipers with a function to hold the display value at any position.

- Measuring range: 0-300 mm.
- Resolution: 0.01 mm.
- mm/inch conversion.
- Digit height: 11 mm.
- On/off switch.
- Reset.
- Hold function.
- Thumb wheel and locking screw.
- Power supply: 1 battery type V357.

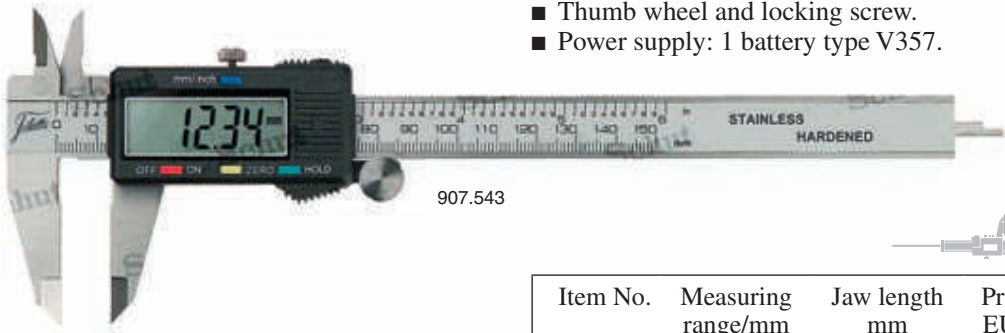

907.543

PRICE

Item No.	Measuring range/mm	Jaw length mm	Price EUR
907.543	0-150	40	28.30
907.544	0-200	50	37.80
907.545	0-300	60	68.00
Option:			
836.535	Spare battery		1.90

Digital calipers with min/max function

By keeping the mode button pressed you can hold the minimum and maximum measuring values.

- Measuring range: 0-300 mm.
- Resolution: 0.01 mm.
- mm/inch conversion.
- Digit height: 11 mm.
- On/off switch.
- Reset.
- Min/max function.
- Thumb wheel and locking screw.
- Power supply: 1 battery type V357.

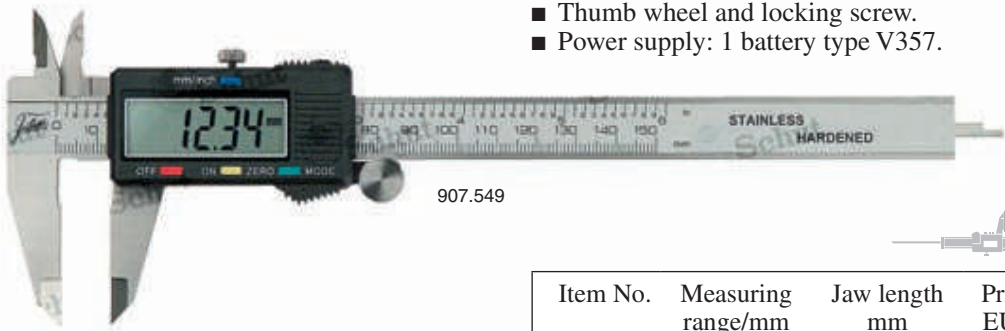

907.549

PRICE

Item No.	Measuring range/mm	Jaw length mm	Price EUR
907.549	0-150	40	31.10
907.550	0-200	50	37.80
907.551	0-300	60	68.00
Option:			
836.535	Spare battery		1.90



Digital calipers 0.005 mm

Calipers with a higher resolution and a measuring range up to 300 mm.

- Measuring range: 0-300 mm.
- Resolution: **0.005 mm**.
- mm/inch conversion.
- ABS/INC switchable.
- On/off switch.
- Thumb wheel (only 906.823).
- Flat depth rod.
- DIN 862.
- Power supply:
906.821/822: 1 battery type V357,
906.823: 1 battery type CR2032.

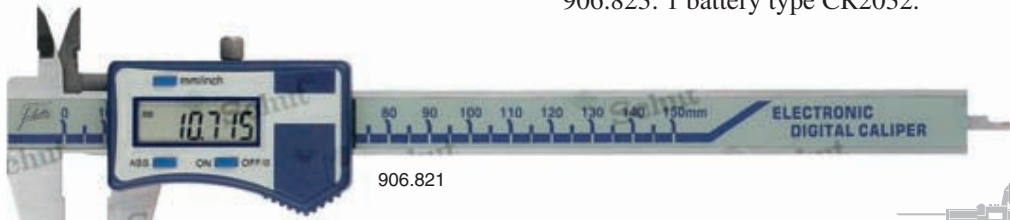

906.821



906.823

Item No.	Measuring range/mm	Jaw length mm	Price EUR
906.821	0-150	40	50.00
906.822	0-200	50	61.00
906.823	0-300	60	102.00
Option:			
836.535	Spare battery type V357		1.90
495.157	Spare battery type CR2032		0.50



Digital solar calipers

The solar power supply functions already with a low illumination level.

- Measuring range: 0-300 mm.
- Resolution: 0.01 mm.
- mm/inch conversion.
- Thumb wheel (except 906.493).
- Flat depth rod.
- Back-up power supply (prevents shut-down in dark places): 1 battery type V389.

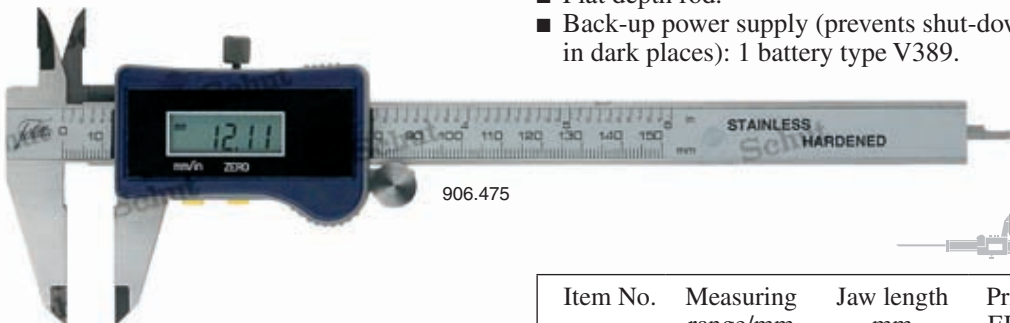

906.475



Item No.	Measuring range/mm	Jaw length mm	Price EUR
906.475	0-150	40	37.00
906.492	0-200	50	60.00
906.493	0-300	60	95.00
Option:			
498.823	Spare battery		1.40



Digital calipers with glass ruler

Equipped with a glass ruler. Very easy displacement by non-contact movement.

- Measuring range: 0 - 300 mm.
- Resolution: 0.01 mm.
- mm/inch conversion.
- ABS/INC switchable (only 909.443/444/445).



- Digit height: 12 mm.
- With data output.
- On/reset switch.
- Automatic switch-off.
- DIN 862.
- Delivery with an inspection report.
- Power supply: 1 battery type CR2025.



909.440



909.440



USB interface:

- For data transfer to PC (e.g. Excel, Word).
- Operating system: Windows and other.
- PC connection: USB data output (cable length 2 m).
- No software or driver to install.
- Foot switch (optional).



909.446

Item No.	Measuring range/mm	Jaw length mm	Price EUR
909.440	0 - 150	40	39.90
909.441	0 - 200	50	58.00
909.442	0 - 300	60	94.00
Absolute calipers:			
909.443	0 - 150	40	44.00
909.444	0 - 200	50	62.00
909.445	0 - 300	60	100.00
Options:			
495.214	Spare battery		0.70
909.446	USB interface		120.00
909.687	Foot switch		17.30

Digital calipers with tolerance function

Digital calipers with function to set tolerance limits with Go/NoGo reading.

- Measuring range: 0 - 300 mm.
- Resolution: 0.01 mm.
- mm/inch conversion.
- With data output.
- Digit height: 12 mm.
- Tolerance function.
- On/reset switch.



- Automatic switch-off.
- DIN 862.
- Delivery with an inspection report.
- Power supply: 1 battery type CR2025.



906.412

Item No.	Measuring range/mm	Jaw length mm	Price EUR
906.412	0 - 150	40	42.00
906.413	0 - 200	50	59.00
906.414	0 - 300	60	89.00
Options:			
495.214	Spare battery		0.70
909.446	USB interface		120.00
909.687	Foot switch		17.30



909.446

USB interface:

- For data transfer to PC (e.g. Excel, Word).
- Operating system: Windows and other.
- PC connection: USB data output (cable length 2 m).
- No software or driver to install.
- Foot switch (optional).

Digital calipers with rotatable LCD display

- Measuring range: 0-300 mm.
- Resolution: 0.01 mm.
- mm/inch conversion.
- On/off switch.
- Automatic switch-off.
- Rotatable display value.
- Thumb wheel and locking screw.
- Flat depth rod.
- Power supply: 1 battery type CR2032.

NEW

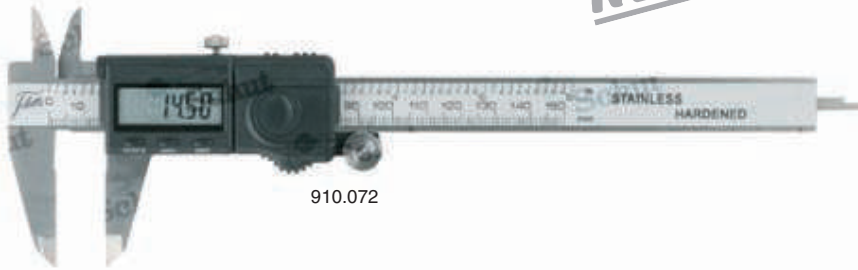

910.072



Item No.	Measuring range/mm	Jaw length mm	Price EUR
910.072	0-150	40	36.80
910.073	0-200	50	56.00
910.074	0-300	60	83.00
Option: 495.157 Spare battery			0.50

Digital calipers with tungsten carbide measuring faces

- Measuring range: 0-300 mm.
- Resolution: 0.01 mm.
- mm/inch conversion.
- On/off switch.
- Reset.
- Power supply: 1 battery type V357.



910.035

NEW



Item No.	Measuring range/mm	Jaw length mm	Price EUR
910.035	0-150	40	93.00
910.036	0-200	50	107.00
910.037	0-300	60	148.00
Option: 836.535 Spare battery			1.90

Absolute digital calipers IP54

Calipers with an absolute measuring system. This gives you the advantage that the caliper stores the one-time setting of the absolute zero position until the battery has to be changed. This reduces the chance of measuring errors and enables you to use the caliper without zero setting.

- Measuring range: 0-300 mm.
- Resolution: 0.01 mm.
- mm/inch conversion.
- ABS/INC switchable.
- Digimatic data output.
- On/off switch.
- Reset.
- Max. measuring speed: any.
- Protection: IP54.
- DIN 862.
- Delivery in a case with an inspection report.
- Power supply: 1 battery type CR2032.

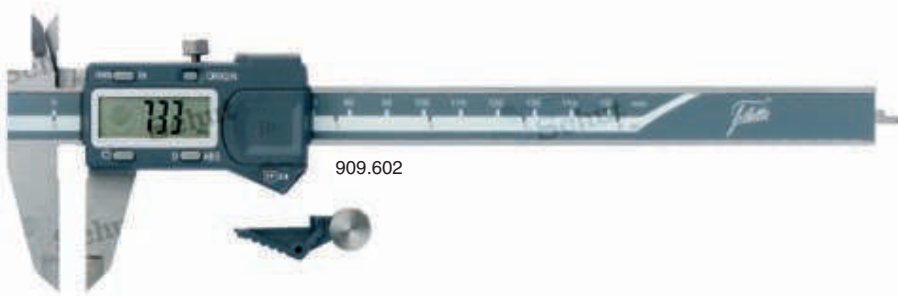

NEW



Item No.	Measuring range/mm	Accuracy mm	Jaw length mm	Price EUR
909.602	0 - 150	0.02	40	52.00
909.603	0 - 200	0.02	50	70.00
909.604	0 - 300	0.03	60	88.00
Options:				
495.157	Spare battery			0.50
909.686	USB interface			101.00
909.687	Footswitch			17.30
910.038	Wireless USB receiver			47.00
910.039	Wireless sender			47.00

Digital calipers IP54

These calipers have a protection degree of IP54 and are therefore protected against splash water and resistant to oil and dust. Zero setting at any position. Equipped with thumb wheel and locking screw.

- Measuring range: 0- 300 mm.
- Resolution: 0.01 mm.
- mm/inch conversion.
- On/off switch.
- Reset.
- Max. measuring speed: 1.5 m/s.
- Thumb wheel and locking screw.
- Flat depth rod.
- Protection: IP54.
- Resistant to workshop conditions.
- Delivery in a case.
- Power supply: 1 battery type V357.

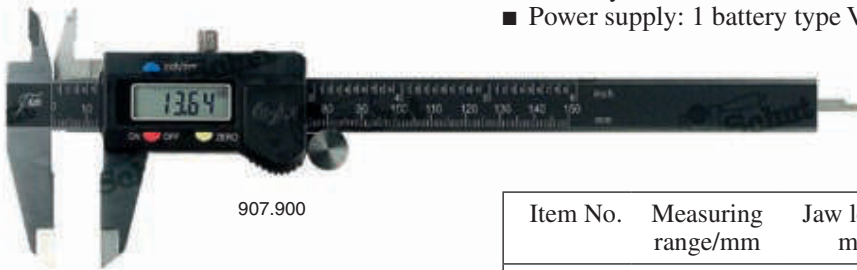

PRICE

Item No.	Measuring range/mm	Jaw length mm	Price EUR
907.900	0- 150	40	34.30
907.901	0- 200	50	49.00
907.902	0- 300	60	70.00
Option:			
836.535	Spare battery		1.90

Digital calipers IP54

- Measuring range: 0- 300 mm.
- Resolution: 0.01 mm.
- mm/inch conversion.
- ABS/INC switchable.
- On/off switch.
- Reset.
- Thumb wheel and locking screw.
- Protection: IP54.
- DIN 862.
- Delivery in a case with an inspection report.
- Power supply: 1 battery type CR2032.

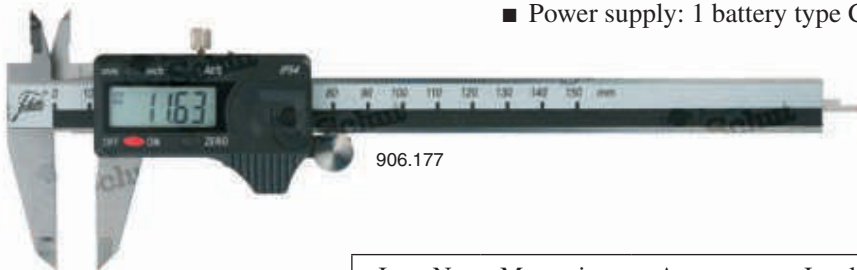

NEW

PRICE

Item No.	Measuring range/mm	Accuracy mm	Jaw length mm	Price EUR
906.177	0- 150	0.03	40	38.60
906.178	0- 200	0.03	50	54.00
906.179	0- 300	0.04	60	79.00
Option:				
495.157	Spare battery			0.50

TESA TWIN-Cal digital calipers IP40

New generation IP40 calipers, TESA TWIN-Cal, with a “soft touch” grip and an excellent price-performance ratio. These calipers have a unique connectivity concept TWIN & LINK. All TWIN-Cal calipers are equipped with a data output. Connect the TESA Link Connector (or TWIN-Cap) to the TWIN-Cal for “plug and play” (wireless) data transfer.

- Measuring range: 0-300 mm.
- Resolution: 0.01 mm.
- mm/inch conversion.
- Digit height: 11 mm.
- Automatic switch-off.
- Reset.
- Max. measuring speed: approx. 2.5 m/s.
- Thumb wheel (except 783.334); also optionally available.
- Locking screw.
- Round ($\varnothing 1.5$ mm) or flat depth rod.
- Protection: IP40.
- DIN 862.
- Standard supplied with data output (USB, Digimatic or wireless).
- Delivery in a case with an inspection report and a declaration of conformity.
- Power supply: 1 battery type CR2032.

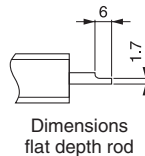

783.331

Dimensions
flat depth rod

TESA Link Connector USB



TESA Link Connector Digimatic



TESA Link Connector TWIN-Cap



TWIN Station

Item No.	Measuring range/mm	Jaw length mm	Depth rod	Price EUR
783.334	0-150	40	flat	109.00
783.331	0-150	40	round	109.00
783.332	0-200	50	flat	156.00
783.333	0-300	64	flat	219.00
Options:				
495.157	Spare battery			0.50
779.362 ¹	Depth measuring base 75 x 6 mm			33.00
783.301 ²	TESA Link Connector USB			118.00
783.302 ²	TESA Link Connector Digimatic			170.00
783.303 ²	TESA Link Connector TWIN-Cap			159.00

¹ Only suitable for the calipers with measuring range 0-150 mm.

² The TESA Link Connector will replace the battery cover.

Mitutoyo Absolute Digimatic calipers

Mitutoyo digital calipers equipped with AOS inductive encoder. The measuring signal is not affected by dirt (water, oil, etc.) on the ruler surface due to the electromagnetic inductive ABS encoder. The one-time setting of origin remains as the absolute zero position until the battery has to be changed.

- Measuring range: 0 - 300 mm.
- Resolution: 0.01 mm.
- ABS/INC switchable.
- With or without Digimatic data output.
- Reset.
- Max. measuring speed: any.
- Flat depth rod (except 500.158, 500.184 and 500.203: round depth rod \varnothing 1.9 mm).
- Protection: IP40.
- DIN 862.



- Delivery in a case.
- Power supply: 1 battery type V357.

Item No.	Measuring range/mm	Jaw length mm	Price EUR
Without Digimatic data output:			
500.181	0 - 150	40	110.00
500.184 ¹	0 - 150	40	110.00
500.182	0 - 200	50	173.00
With Digimatic data output:			
500.161	0 - 150	40	136.00
500.203 ¹	0 - 150	40	138.00
500.158 ^{1,2}	0 - 150	40	159.00
500.162	0 - 200	50	194.00
500.152 ²	0 - 200	50	226.00
500.205	0 - 300	64	359.00
500.153 ²	0 - 300	64	402.00

Options

Item No.	Description	Price EUR
836.535	Spare battery	1.90
959.149 ³	Digimatic signal cable 1 m	40.00
959.150 ³	Digimatic signal cable 2 m	46.00
106.382 ³	USB Input Tool Direct cable 2 m	104.00
102.793 ³	U-WAVE data cable	92.00

¹ With round depth rod \varnothing 1.9 mm.

² With thumb wheel.

³ With data switch.

Mitutoyo Absolute Digimatic Solar calipers

Because of the Solar power supply you never have to replace a battery, and it functions already with a low illumination level. The built-in battery enables working with insufficient light.

- Measuring range: 0 - 150 mm.
- Resolution: 0.01 mm.
- Digimatic data output (only 500.778).
- Reset.
- Max. measuring speed: any.
- Jaw length: 40 mm.
- Flat depth rod (except 500.792: round depth rod \varnothing 1.9 mm).
- Illumination: minimal 60 lux.
- Protection: IP67 (except 500.457: IP40).
- DIN 862.
- Delivery in a case.

- Also available with thumb wheel and measuring range 200 mm.



Item No.	Measuring range/mm	Price EUR
500.457	0 - 150	145.00
500.772	0 - 150	193.00
500.792	0 - 150	193.00
500.778	0 - 150	252.00



Digital carbon fiber calipers

Digital calipers made of carbon fiber.

- Measuring range: 0-300 mm.
- Resolution: 0.1 mm.
- mm/inch conversion.
- On/off switch.
- Automatic switch-off.
- Reset.
- Flat depth rod (only 909.420).
- Power supply:
909.420/688: 1 battery type CR2032,
909.689: 1 battery type V357.

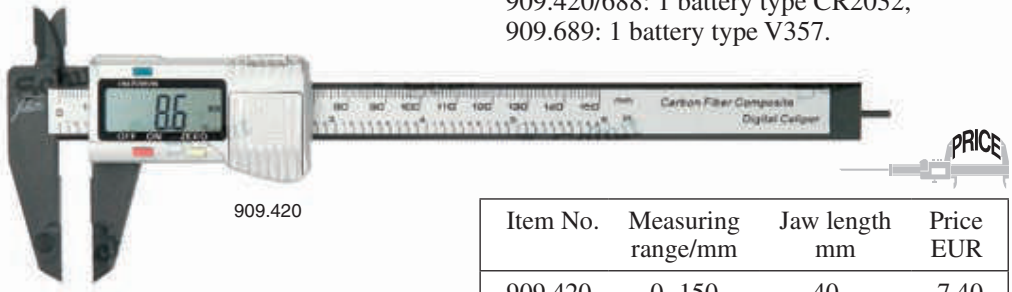

909.420



Item No.	Measuring range/mm	Jaw length mm	Price EUR
909.420	0-150	40	7.40
909.688	0-150	75	11.20
909.689	0-300	90.5	25.90

Options:

- 495.157 Spare battery type CR2032 0.50
- 836.535 Spare battery type V357 1.90

Digital calipers IP67

These IP67 protected calipers are especially suitable for use in production environments: they are fully protected against dust intrusion and even last temporary immersion.

- Measuring range: 0-300 mm.
- Resolution: 0.01 mm.
- mm/inch conversion.
- Automatic switch-off.
- Reset.
- Thumb wheel and locking screw.
- Flat depth rod.
- Protection: IP67.
- DIN 862.
- Delivery with an inspection report.
- Power supply: 1 battery type CR2032.

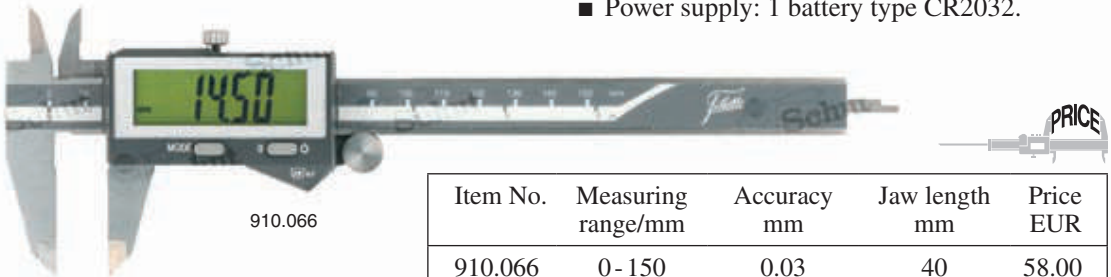

910.066

NEW



Item No.	Measuring range/mm	Accuracy mm	Jaw length mm	Price EUR
910.066	0-150	0.03	40	58.00
910.067	0-200	0.03	50	73.00
910.068	0-300	0.04	60	101.00

With Bluetooth:

- 910.069 0-150 0.03 40 73.00

Option:

- 495.157 Spare battery 0.50

Digital calipers IP67

These IP67 protected calipers are especially suitable for use in production environments: they are fully protected against dust intrusion and even last temporary immersion.

- Measuring range: 0-300 mm.
- Resolution: 0.01 mm.
- mm/inch conversion.
- Automatic switch-off.
- Reset.
- Locking screw.
- Flat depth rod.
- Protection: IP67.
- DIN 862.
- Power supply: 1 battery type CR2032.

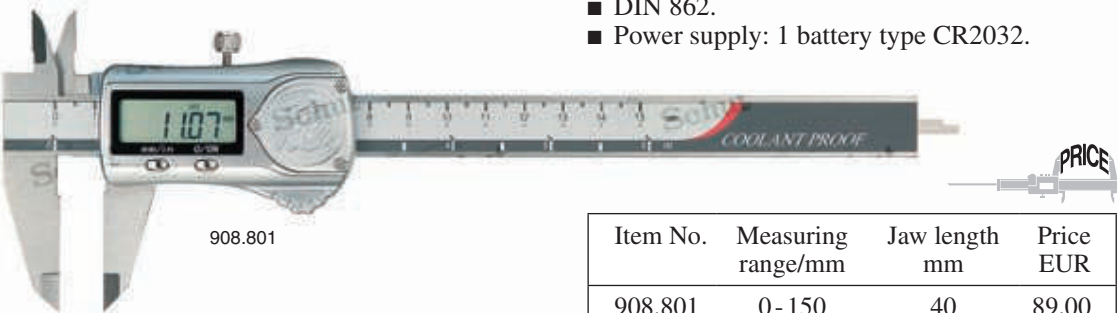

908.801

Item No.	Measuring range/mm	Jaw length mm	Price EUR
908.801	0-150	40	89.00
908.802	0-200	50	113.00
908.803	0-300	60	140.00
Option:			
495.157	Spare battery		0.50

Digital calipers IP67

These IP67 protected calipers are especially suitable for use in production environments: they are fully protected against dust intrusion and even lasts temporary immersion.

- Measuring range: 0-300 mm.
- Resolution: 0.01 mm.
- mm/inch conversion.
- Large, easy to read LCD display.
- On/reset switch.
- Automatic switch-off.
- Thumb wheel and locking screw.
- Stable flat depth rod.
- Protected rack.
- Protection: IP67.
- DIN 862.
- Delivery with an inspection report.
- Power supply: 1 battery type V357.

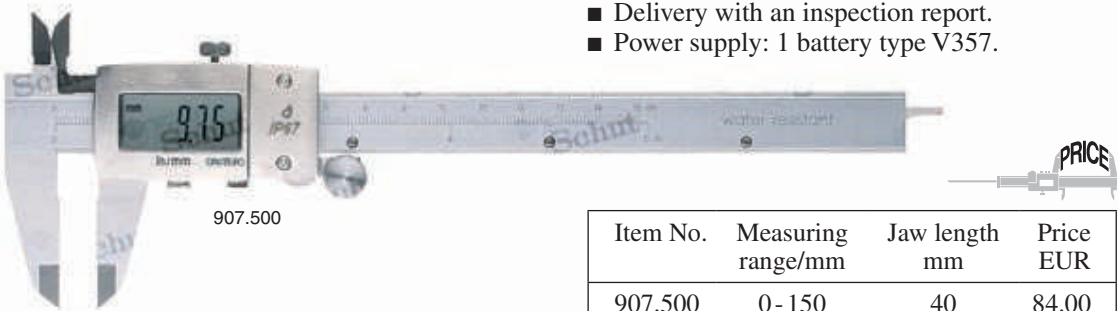

907.500

Item No.	Measuring range/mm	Jaw length mm	Price EUR
907.500	0-150	40	84.00
907.501	0-200	50	132.00
907.502	0-300	60	180.00
Option:			
836.535	Spare battery		1.90



TESA TWIN-Cal absolute digital calipers IP67

New generation IP67 calipers, TESA TWIN-Cal, with an absolute measuring system and a “soft touch” grip. These calipers have a unique connectivity concept TWIN & LINK. All TWIN-Cal calipers are equipped with a data output. Connect the TESA Link Connector (or TWIN-Cap) to the TWIN-Cal for “plug and play” (wireless) data transfer.

- Measuring range: 0-300 mm.
- Resolution: 0.01 mm.
- Repeatability: 0.01 mm.
- mm/inch conversion.
- Digit height: 11 mm.
- Automatic switch-off.
- Reset.
- Max. measuring speed: approx. 2.5 m/s.
- Thumb wheel (except 783.290/291); also optionally available.
- Locking screw.
- Round ($\varnothing 1.5$ mm) or flat depth rod.
- Protection: IP67 (also in combination with data output cable).
- DIN 862.
- Standard supplied with data output (USB, Digimatic or wireless).
- Delivery in a case with an inspection report and a declaration of conformity.
- Power supply: 1 battery type CR2032.

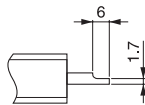

Dimensions
flat depth rod

Item No.	Measuring range/mm	Jaw length mm	Depth rod	Price EUR
783.290	0-150	40	flat	159.00
783.291	0-150	40	round	159.00
783.292	0-150	40	round	159.00
783.293	0-200	50	flat	222.00
783.294	0-300	64	flat	305.00
Options:				
495.157	Spare battery			0.50
779.362 ¹	Depth measuring base 75 x 6 mm			33.00
783.300 ¹	Thumb wheel			9.00
783.301 ²	TESA Link Connector USB			118.00
783.302 ²	TESA Link Connector Digimatic			170.00
783.303 ²	TESA Link Connector TWIN-Cap			159.00

¹ Only suitable for the calipers with measuring range 0-150 mm.

² The TESA Link Connector will replace the battery cover.



TESA Link Connector USB



TESA Link Connector Digimatic



TESA Link Connector TWIN-Cap



TWIN Station

Mitutoyo Absolute Digimatic Coolant Proof calipers IP67

Series digital calipers with the unique Absolute measuring system to prevent inaccuracy because of an incorrect zero position. These IP67 protected calipers are especially suitable for use in production environments; they even last temporary immersion. The one-time setting of origin remains as the absolute zero position until the battery has to be changed.

- Measuring range: 0-300 mm.
- Resolution: 0.01 mm.
- With or without Digimatic data output.
- Digit height: 9 mm.
- Automatic switch-off.
- Reset.
- Max. measuring speed: any.
- Locking screw.
- Flat depth rod (except 500.709: round depth rod \varnothing 1.9 mm).
- Protection: IP67.
- DIN 862.
- Battery life: approx. 18 000 hours.
- Delivery in a case with an inspection report and a declaration of conformity.
- Power supply: 1 battery type V357.
- Also available with thumb wheel.

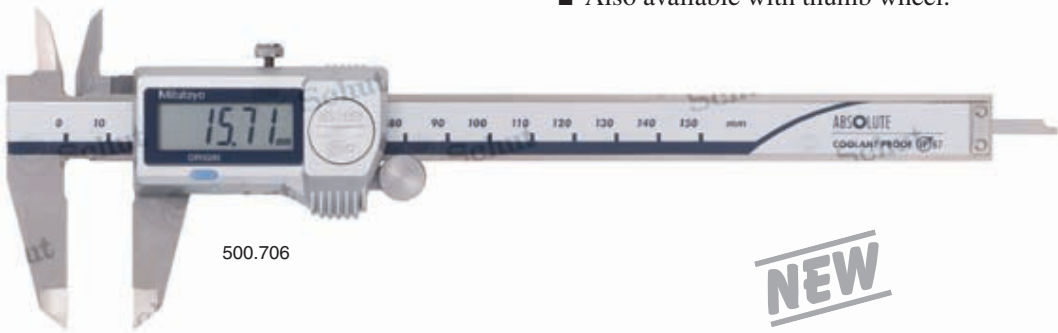

Item No.	Measuring range/mm	Jaw length mm	Price EUR
Without Digimatic data output:			
500.706	0 - 150	40	163.00
500.709 ¹	0 - 150	40	163.00
500.707	0 - 200	50	230.00
500.708	0 - 300	64	309.00
With Digimatic data output:			
500.716	0 - 150	40	209.00
500.727 ²	0 - 150	40	413.00
500.717	0 - 200	50	265.00
500.728 ²	0 - 200	50	471.00
500.718	0 - 300	64	349.00
Options:			
836.535	Spare battery		1.90
105.624 ³	Digimatic signal cable, 1 m		73.00
105.625 ³	Digimatic signal cable, 2 m		84.00
106.381 ³	USB Input Tool Direct cable 2 m		119.00
102.792 ³	U-WAVE data cable		97.00



¹ With round depth rod \varnothing 1.9 mm.

² Provided with tungsten carbide measuring faces.

³ With data switch.

Digital calipers with slidable measuring jaw

For measuring distances between planes at different levels. Very suitable as scribing tool!

- Measuring range: 0 - 500 mm.
- Resolution: 0.01 mm.
- mm/inch conversion.
- On/off switch.
- Reset.
- Thumb wheel and locking screw.
- Power supply: 1 battery type V357.

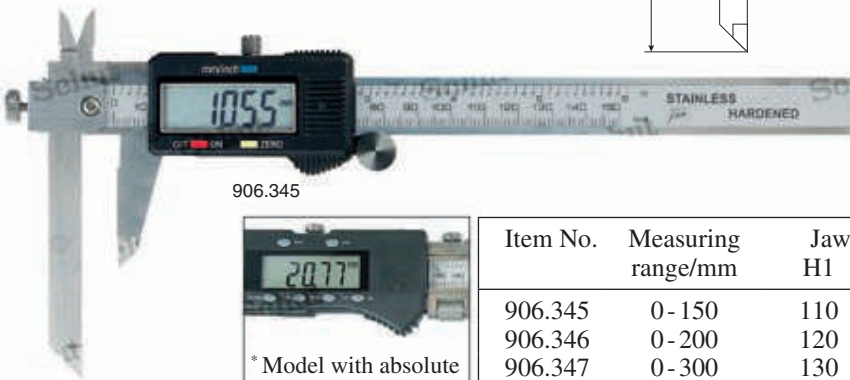
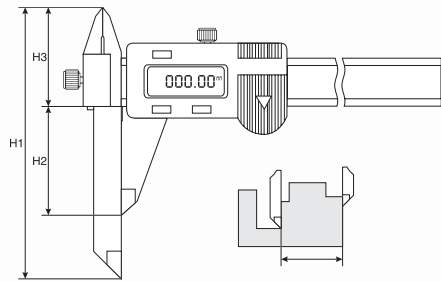

906.345



Item No.	Measuring range/mm	Jaw length/mm			Price EUR
		H1	H2	H3	
906.345	0 - 150	110	40	37	81.00
906.346	0 - 200	120	50	40	115.00
906.347	0 - 300	130	60	42	157.00
906.348*	0 - 500	210	100	66	200.00
Option: 836.535 Spare battery					1.90



Digital calipers for measuring center distances

Suited for measuring center distances between bores from $\varnothing 1$ up to 4.5 mm. Because both measuring jaws are adjustable in height it is possible to measure center distances between bores that are positioned at different levels.

- Measuring range: 5 - 300 mm.
 - Resolution: 0.01 mm.
 - mm/inch conversion.
 - On/off switch.
 - Reset.
 - Locking screw.
- Power supply: 1 battery type V357.



906.395

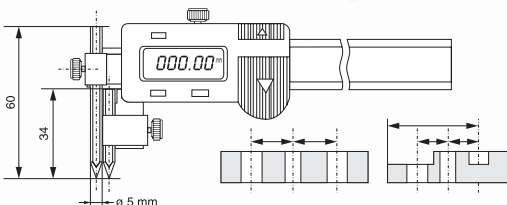

Item No.	Measuring range/mm	Price EUR
906.395	5 - 150	98.00
906.396	5 - 200	113.00
906.397	5 - 300	151.00
Option: 836.535 Spare battery		1.90

Digital calipers with pointed measuring jaws

The pointed measuring jaws of these calipers enable you to measure distances in places that are hard to reach.

- Measuring range: 0-300 mm.
- Resolution: 0.01 mm.
- mm/inch conversion.
- On/off switch.
- Reset.
- Power supply: 1 battery type V357.

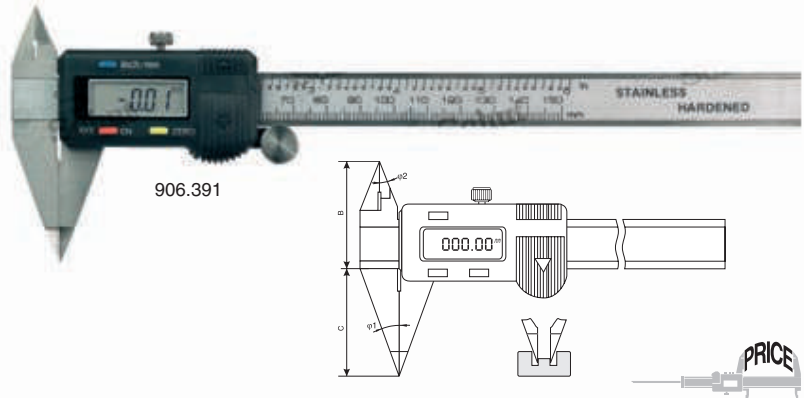

Item No.	Measuring range/mm	Jaw length C/mm	Length B/mm	Angle φ1	Angle φ2	Price EUR
906.391	0-150	40	37	20°	20°	48.00
906.392	0-200	50	40	20°	22.5°	69.00
906.393	0-300	60	42	20°	22.5°	106.00
Option: 836.535 Spare battery						1.90



Digital calipers with outside angled measuring jaws

These calipers have short, stable, V-shaped measuring jaws with a flat front. Specially designed for measuring bore and internal groove diameters.

- Measuring range: 8-200 mm.
- Resolution: 0.01 mm.
- mm/inch conversion.
- On/off switch.
- Preset at 10 mm (delivery incl. setting ring).
- Preset through SET, + and - switches.
- Thickness measuring face: 0.5 mm.
- Power supply: 1 battery type V357.



Item No.	Measuring range/mm	Length/mm			Price EUR
		A	B	C	
907.556	8-150	1.5	3.5	27.5	86.00
907.557	8-200	1.5	3.5	27.5	111.00
Option: 836.535 Spare battery					1.90

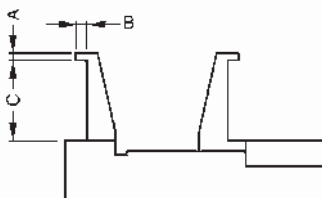

Digital calipers with outside angled measuring pins

These calipers are equipped with outside angled rounded pins.

- Measuring range: 35 - 500 mm.
- Resolution: 0.01 mm.
- mm/inch conversion.
- On/off switch.
- Reset.
- Thumb wheel and locking screw.
- Power supply: 1 battery type V357.

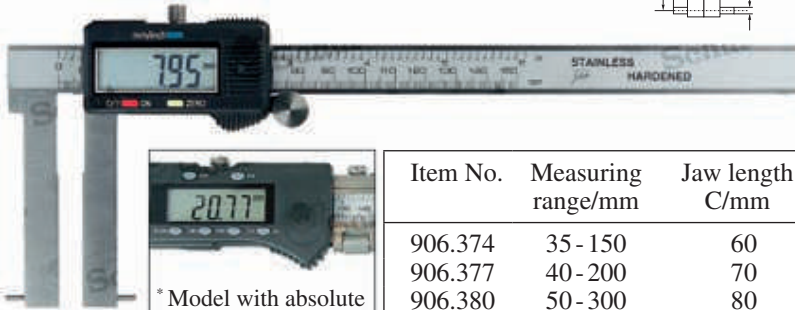
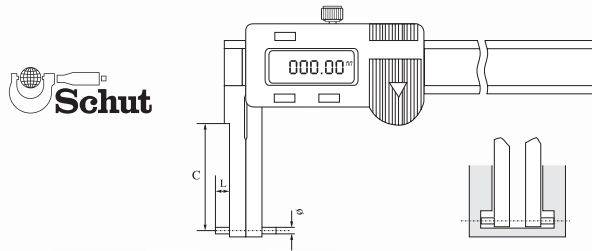

906.374



* Model with absolute digital display, without thumb wheel, with fine adjustment and preset function.

Item No.	Measuring range/mm	Jaw length C/mm	Pin \varnothing /mm	Pin length L/mm	Price EUR
906.374	35 - 150	60	2	6	101.00
906.377	40 - 200	70	3	7	131.00
906.380	50 - 300	80	3	10	155.00
906.383*	60 - 500	105	3	10	251.00
Option:					
836.535	Spare battery				1.90

Digital calipers with inside angled measuring pins

These calipers are equipped with inside angled rounded pins.

- Measuring range: 0 - 500 mm.
- Resolution: 0.01 mm.
- mm/inch conversion.
- On/off switch.
- Reset.
- Thumb wheel and locking screw.
- Power supply: 1 battery type V357.

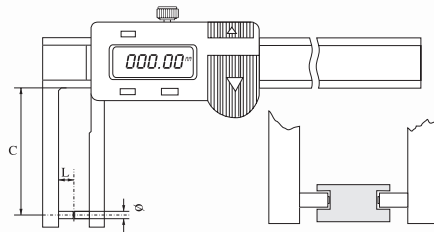

906.368



* Model with absolute digital display, without thumb wheel, with fine adjustment and preset function.

Item No.	Measuring range/mm	Jaw length C/mm	Pin \varnothing /mm	Pin length L/mm	Price EUR
906.368	0 - 150	40	2	5	65.00
906.369	0 - 200	50	2.5	8	75.00
906.370	0 - 300	60	2.5	10	115.00
906.371*	0 - 500	100	3	12	158.00
Option:					
836.535	Spare battery				1.90

Digital calipers with outside angled measuring jaws

These calipers are equipped with outside angled V-shaped measuring jaws.

- Measuring range: 35 - 500 mm.
- Resolution: 0.01 mm.
- mm/inch conversion.
- On/off switch.
- Reset.
- Thumb wheel and locking screw.
- Power supply:
1 battery type V357.

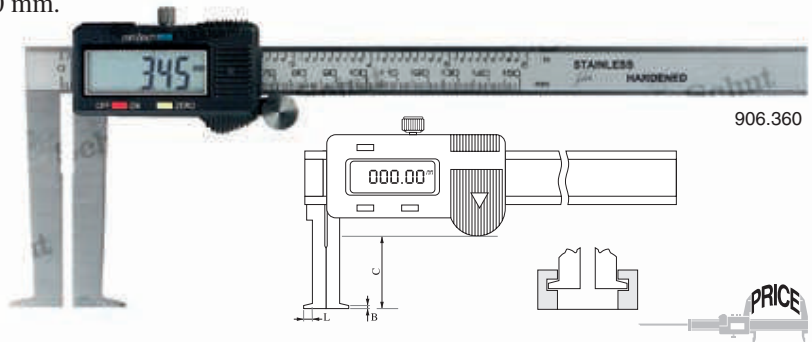

Item No.	Measuring range/mm	Jaw length C/mm	Measuring face B/mm	Jaw length L/mm	Price EUR
906.360	35 - 150	50	1.5	6	80.00
906.361	40 - 200	60	1.5	7	93.00
906.362	50 - 300	70	1.5	8	138.00
906.363*	60 - 500	110	2	10	220.00
Option: 836.535 Spare battery					1.90

Digital calipers with inside angled measuring jaws

These calipers are equipped with inside angled V-shaped measuring jaws.

- Measuring range: 0 - 500 mm.
- Resolution: 0.01 mm.
- mm/inch conversion.
- On/off switch.
- Reset.
- Thumb wheel and locking screw.
- Power supply:
1 battery type V357.

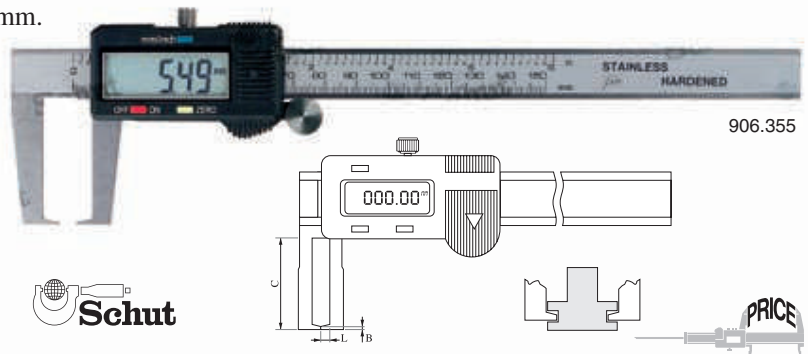

Item No.	Measuring range/mm	Jaw length C/mm	Measuring face B/mm	Jaw length L/mm	Price EUR
906.355	0 - 150	40	1	5	63.00
906.356	0 - 200	50	1	7	78.00
906.357	0 - 300	60	1.5	8	111.00
906.358*	0 - 500	100	2	12	173.00
Option: 836.535 Spare battery					1.90

Digital calipers for internal length measurement

Calipers with outside angled, pointed measuring jaws for the measurement of for example internal grooves.

- Measuring range: 0-200 mm.
- Resolution: 0.01 mm.
- mm/inch conversion.
- On/reset switch.
- Locking screw.
- Power supply: 1 battery type V357.



906.386

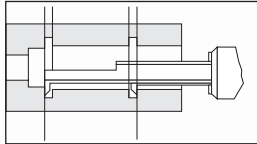
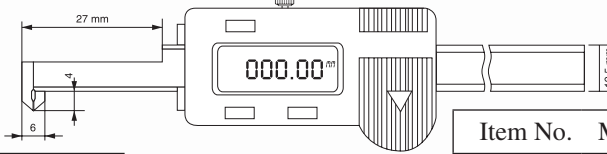

Item No.	Measuring range/mm	Price EUR
906.386	0 - 140	80.00
906.387	0 - 200	95.00
Option:		
836.535	Spare battery	1.90

Digital caliper for groove measurements

- Measuring range: 0-125 mm.
- Resolution: 0.01 mm.
- mm/inch conversion.
- On/off switch.
- Reset.
- Equipped with small measuring jaws on top of the caliper.
- Thumb wheel and locking screw.
- Also suitable for:
 - internal diameter attached collar,
 - internal diameter U-shaped flange on axis,
 - center distances blind holes under-surface flange on axis,
 - hole diameter hard-to-reach places,
 - height measurement,
 - groove width and groove distance.
- Power supply: 1 battery type V357.

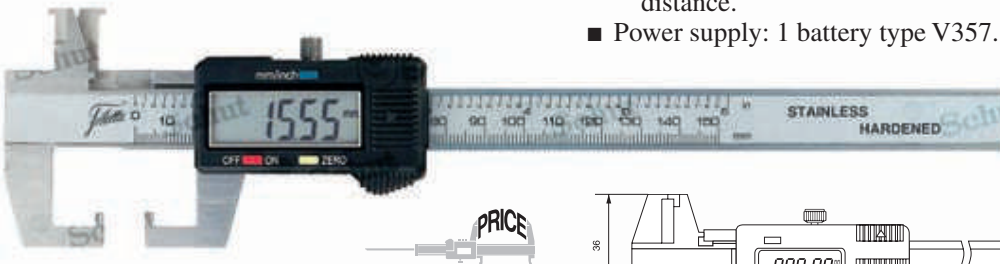

PRICE

Item No.	Measuring range/mm	Price EUR
906.365	0 - 125	104.00
Option:		
836.535	Spare battery	1.90

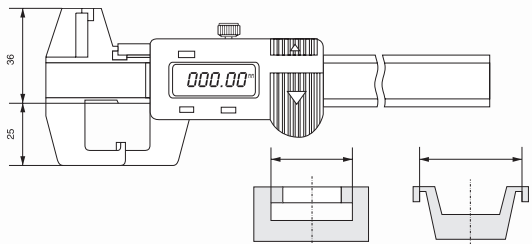

Digital calipers with pointed anvil

Because of the pointed anvil and the long measuring jaws you can measure with these calipers all sorts of wall thicknesses in places that are hard to reach and of for example round surfaces.

- Measuring range: 0- 150 mm.
- Resolution: 0.01 mm.
- mm/inch conversion.
- On/off switch.
- Reset.
- Power supply: 1 battery type V357.

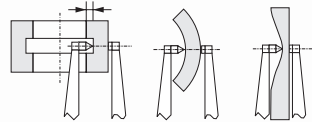
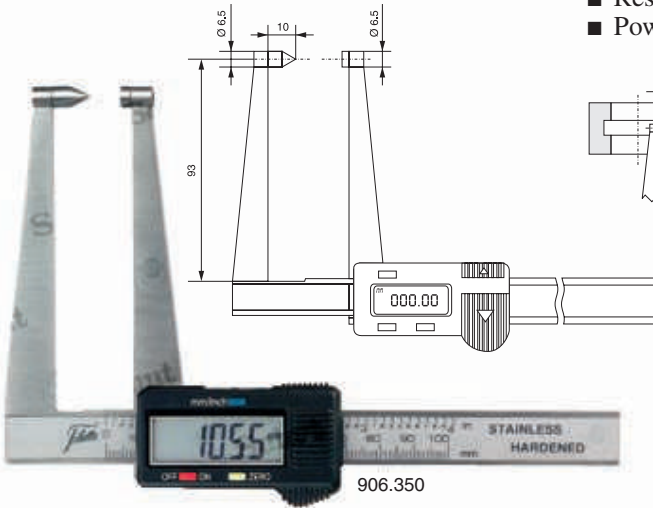

Item No.	Measuring range/mm	Price EUR
906.350	0- 75	83.00
906.351	0- 125	92.00
906.352	0- 150	102.00
Option:		
836.535	Spare battery	1.90

Digital caliper with square, pointed anvil

Because of the pointed anvil and the long measuring jaws you can measure with this caliper all sorts of wall thicknesses in places that are hard to reach and of for example round surfaces.

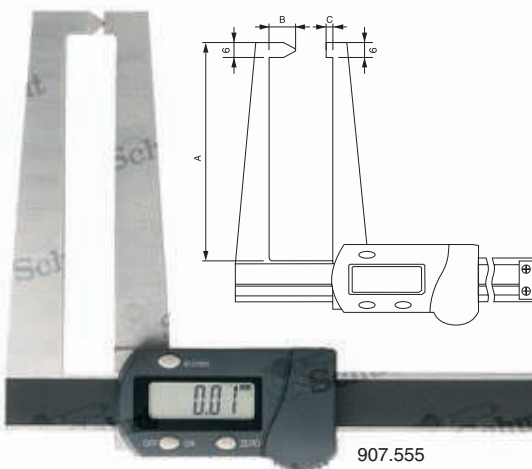

- Measuring range: 0- 150 mm.
- Resolution: 0.01 mm.
- mm/inch conversion.
- Digit height: 10 mm.
- On/off switch.
- Reset.
- Anvil: height 1 mm, width 0.5 mm.
- Measuring face: height 6 mm, width 3 mm.
- Power supply: 1 battery type V357.



Item No.	Measuring range/mm	Length/mm			Price EUR
		A	B	C	
907.555	0- 150	95	10	3	69.00
Option:					
836.535	Spare battery				1.90



Digital calipers with prismatic anvil

Digital calipers with prismatic anvil for measuring objects with an uneven number of grooves like cutters, reamers and drills. The angle of the prism aperture is designed for workpieces having a number of 3 or 5 flutes.

- Measuring range: 1 - 40 mm.
- Resolution: 0.01 mm.
- Accuracy: ± 0.05 mm.
- mm/inch conversion.
- On/off switch.
- Reset through SET switch.
- Max. measuring speed: 1.5 m/s.
- Including setting gauge $\varnothing 4$ mm (907.552) or $\varnothing 1$ mm (907.553).
- Power supply: 1 battery type V357.



Item No.	For work-pieces with	Measuring range/mm	Price EUR
907.552	3 flutes	4 - 40	105.00
907.553	5 flutes	1 - 40	105.00
Option:			
836.535	Spare battery		1.90

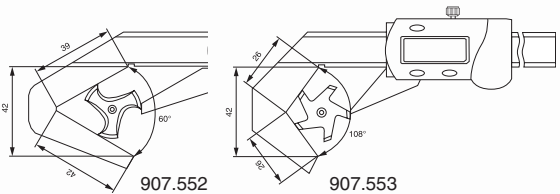

Digital gear tooth thickness calipers

The vertical slider sets the height (H) from the top of the tooth to the pitch line. Subsequently, the horizontal slider measures the tooth thickness (G) at the pitch line.

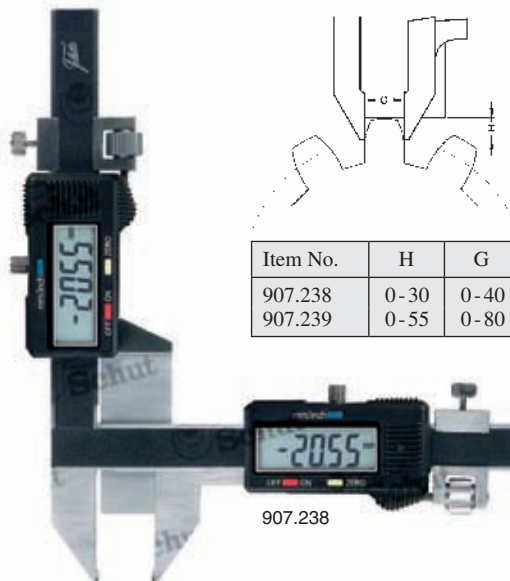

Item No.	H	G
907.238	0 - 30	0 - 40
907.239	0 - 55	0 - 80

- Measuring range: module 1 - 50.
- Resolution: 0.01 mm.
- mm/inch conversion.
- On/off switch.
- Reset.
- Fine adjustment.
- Locking screw.
- Tungsten carbide measuring faces.
- Power supply: 2 batteries type V357.

Item No.	Module	Price EUR
907.238	1 - 30	130.00
907.239	5 - 50	163.00
Option:		
836.535	Spare battery (2 needed)	1.90

Digital calipers for internal measurements

Calipers with long measuring jaws for internal measurements.

- Measuring range: 15 - 300 mm.
- Resolution: 0.01 mm.
- mm/inch conversion.
- ABS/INC switchable.
- On/off switch.
- Reset.
- Locking screw.
- Delivery with an inspection report.
- Power supply: 1 battery type V357.



906.824

PRICE



* Model with absolute digital display, fine adjustment and preset function.

Item No.	Measuring range/mm	Effective jaw length mm	Price EUR
906.824	15 - 150	50	67.00
906.825*	25 - 150	130	114.00
906.826	18 - 200	65	69.00
906.827*	25 - 200	130	117.00
906.828	20 - 300	80	114.00
906.829*	25 - 300	130	134.00
Option:			
836.535	Spare battery		1.90

Brake disc calipers

Brake disc calipers especially for measuring the groove depth of brake discs.

- Measuring range: 0 - 90 mm.
- Vernier: 0.1 mm.
- Locking screw.
- Stainless steel construction.

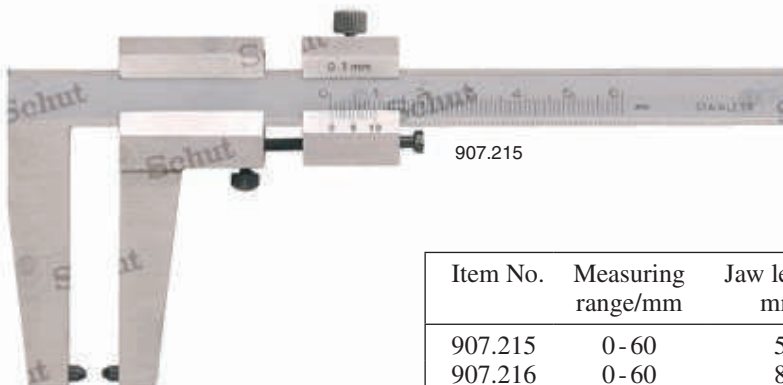

907.215

PRICE

Item No.	Measuring range/mm	Jaw length mm	Price EUR
907.215	0 - 60	55	24.50
907.216	0 - 60	80	43.00
907.217	0 - 90	120	82.00

Mitutoyo special-purpose calipers

Mitutoyo special-purpose analog (vernier) and digital (Absolute Digimatic *Coolant Proof IP67*) calipers. For more information please contact our sales department.

NEW

Item No.	Measuring range/mm	Read-out* mm	Price EUR
With thinner tungsten carbide measuring jaws (thickness 0.75 mm):			
536.134	0 - 150	0.05 ^(V)	359.00
536.135	0 - 200	0.05 ^(V)	389.00
573.635	0 - 150	0.01 ^(D)	609.00
With pointed measuring jaws:			
536.121	0 - 150	0.05 ^(V)	188.00
573.622	0 - 150	0.01 ^(D)	420.00
With thin pointed measuring jaws:			
573.626	0 - 150	0.01 ^(D)	473.00
For scribing, with tungsten carbide measuring jaws:			
536.221	0 - 150	0.05 ^(V)	139.00
536.222	0 - 200	0.05 ^(V)	167.00
536.223	0 - 300	0.05 ^(V)	356.00
573.676	0 - 150	0.01 ^(D)	310.00
573.677	0 - 200	0.01 ^(D)	405.00
573.679	0 - 300	0.01 ^(D)	914.00
With slidable measuring jaw:			
536.101	0 - 150	0.05 ^(V)	261.00
536.102	0 - 200	0.05 ^(V)	317.00
536.103	0 - 300	0.05 ^(V)	424.00
573.611	0 - 150	0.01 ^(D)	536.00
573.612	0 - 200	0.01 ^(D)	599.00
573.614	0 - 300	0.01 ^(D)	749.00
For center distances:			
536.105	10 - 150	0.05 ^(V)	352.00
536.106	10 - 200	0.05 ^(V)	410.00
536.107	10 - 300	0.05 ^(V)	496.00
573.615	10 - 160	0.01 ^(D)	504.00
573.616	10 - 210	0.01 ^(D)	567.00
573.618	10 - 310	0.01 ^(D)	749.00

* V = vernier read-out, D = digital read-out.



 **Schut**

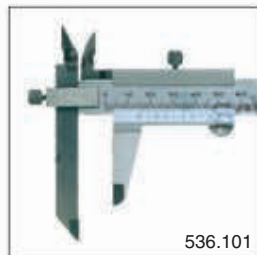

Mitutoyo special-purpose calipers (continued)

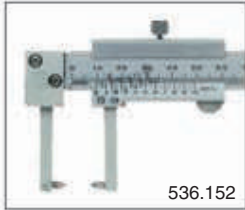

536.152



573.654

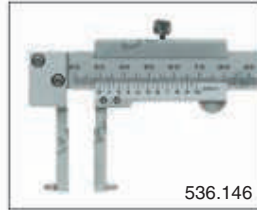

536.146



573.648

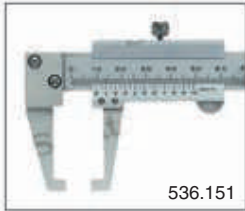

536.151



573.653

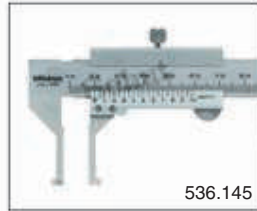

536.145



573.647



NEW

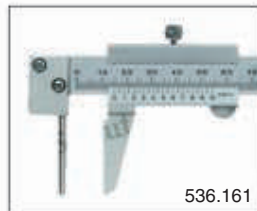

536.161



573.662

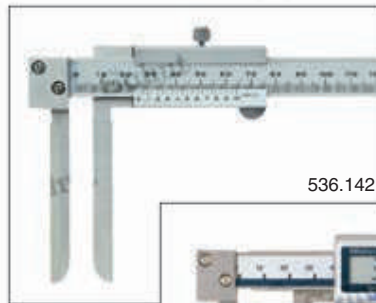

536.142



573.643

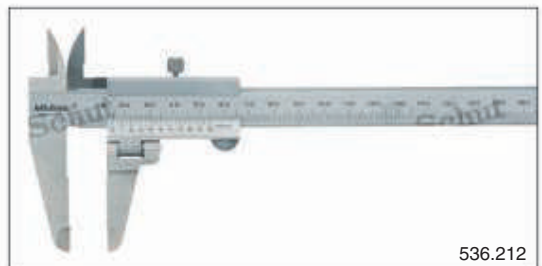

536.212

Item No.	Measuring range/mm	Read-out* mm	Price EUR
With inside angled measuring pins:			
536.152	0 - 150	0.05 ^(V)	451.00
573.654	0 - 150	0.01 ^(D)	630.00
With inside angled measuring jaws:			
536.151	0 - 150	0.05 ^(V)	351.00
573.653	0 - 150	0.01 ^(D)	536.00
With outside angled measuring pins:			
536.146	20 - 150	0.05 ^(V)	413.00
536.147	30 - 300	0.05 ^(V)	454.00
536.148	70 - 450	0.05 ^(V)	853.00
536.149	70 - 600	0.05 ^(V)	877.00
573.648	20 - 170	0.01 ^(D)	641.00
With outside angled measuring jaws:			
536.145	10 - 150	0.05 ^(V)	428.00
573.647	10 - 160	0.01 ^(D)	609.00
For tube wall thickness measurements:			
536.161	0 - 150	0.05 ^(V)	316.00
573.662	0 - 150	0.01 ^(D)	536.00
For internal measurements:			
536.142	10 - 200	0.05 ^(V)	573.00
573.643	10 - 200	0.01 ^(D)	694.00
With swivelling measuring jaw:			
536.212	0 - 200	0.05 ^(V)	561.00

* V = vernier read-out, D = digital read-out.

Absolute digital workshop calipers

- Measuring range: 0 - 2000 mm.
- Resolution: 0.01 mm.
- mm/inch conversion.
- ABS/INC switchable (except 906.460/686/708).
- On/off switch.
- Reset.



- Preset (except 906.460/686/708).
- Memory for measuring values when the display is switched off.
- Fine adjustment.
- Rounded jaw ends for internal measurements.
- Power supply: 1 battery type CR2032 (except 906.460/686/708).

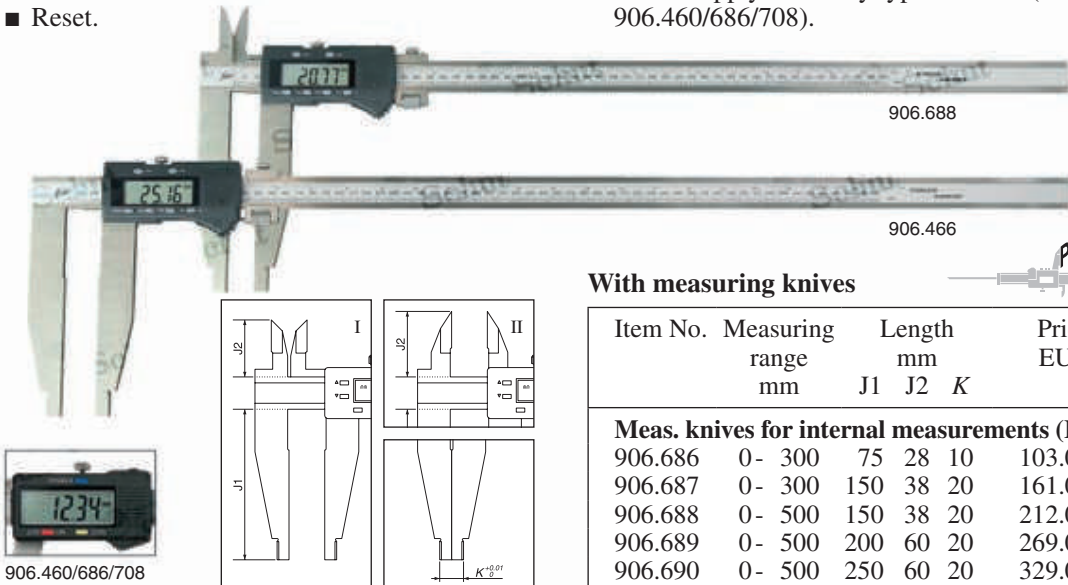

906.460/686/708

Without measuring knives

Item No.	Measuring range mm	Length mm		Price EUR
		J1	K	
906.708	0- 300	75	10	92.00
906.709	0- 300	150	20	136.00
906.465	0- 500	150	20	197.00
906.470	0- 500	200	20	245.00
906.718	0- 500	250	20	282.00
906.466	0- 600	150	20	275.00
906.471	0- 600	200	20	380.00
906.719	0- 600	300	20	415.00
906.467	0-1000	200	20	596.00
906.472	0-1000	300	20	856.00
906.468	0-1500	200	20	940.00
906.473	0-1500	300	20	1,304.00
906.469	0-2000	200	20	1,503.00
906.474	0-2000	300	20	1,956.00

Item No.	Description	Price EUR
495.157	Spare battery type CR2032	0.50
836.535	Spare battery type V357	1.90

With measuring knives

Item No.	Measuring range mm	Length mm			Price EUR
		J1	J2	K	
Meas. knives for internal measurements (I):					
906.686	0- 300	75	28	10	103.00
906.687	0- 300	150	38	20	161.00
906.688	0- 500	150	38	20	212.00
906.689	0- 500	200	60	20	269.00
906.690	0- 500	250	60	20	329.00
906.691	0- 600	150	45	20	279.00
906.692	0- 600	200	60	20	358.00
906.693	0- 600	300	60	20	501.00
906.694	0-1000	200	60	20	627.00
906.695	0-1000	300	60	20	911.00
906.696	0-1500	200	60	20	1,002.00
906.697	0-1500	300	60	20	1,361.00
906.698	0-2000	200	60	20	1,511.00
906.699	0-2000	300	60	20	2,020.00
Meas. knives for external measurements (II):					
906.460	0- 300	75	38	10	114.00
906.758	0- 300	150	56	20	160.00
906.461	0- 500	150	56	20	225.00
906.759	0- 500	200	67	20	260.00
906.760	0- 500	250	80	20	323.00
906.761	0- 600	150	56	20	274.00
906.762	0- 600	200	67	20	354.00
906.763	0- 600	300	80	20	434.00
906.462	0-1000	200	67	20	697.00
906.764	0-1000	300	80	20	913.00
906.463	0-1500	200	80	20	1,096.00
906.765	0-1500	300	80	20	1,336.00
906.464	0-2000	200	80	20	1,622.00
906.766	0-2000	300	80	20	1,990.00



Digital aluminum workshop calipers

Lightweight digital aluminum workshop calipers with both measuring jaws moveable.

- Measuring range: 0- 1500 mm.
- Resolution: 0.1 mm.
- mm/inch conversion.
- ABS/INC switchable.
- On/off switch.
- Reset.
- Aluminum scale with hollow construction (8 x 30 mm).
- Both of the measuring jaws can be moved.
- Delivery in a case.
- Power supply: 1 battery type V357.

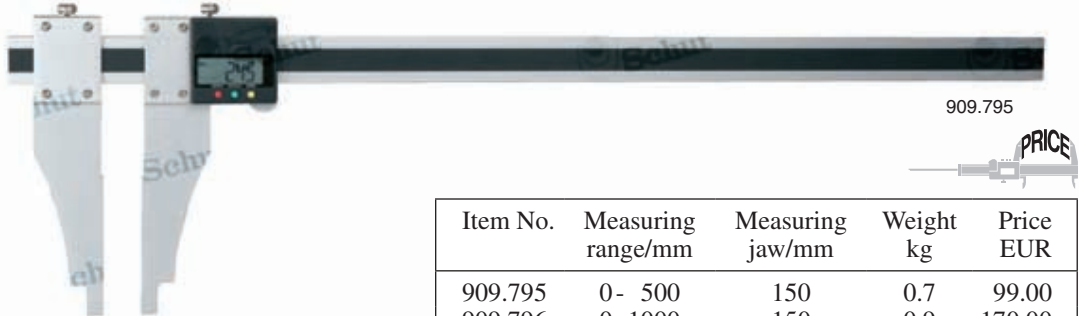

909.795

Item No.	Measuring range/mm	Measuring jaw/mm	Weight kg	Price EUR
909.795	0- 500	150	0.7	99.00
909.796	0- 1000	150	0.9	170.00
909.797	0- 1500	150	1.1	298.00
Option:				
836.535	Spare battery			1.90

Digital lightweight carbon workshop calipers

Different models are available in many lengths. Calipers can be supplied with for instance extra long measuring jaws, TiN coated or hardened measuring jaws or both measuring jaws moveable. There are also models where special inserts or slide on probes can be used for measuring for instance center distances, grooves or diameters.

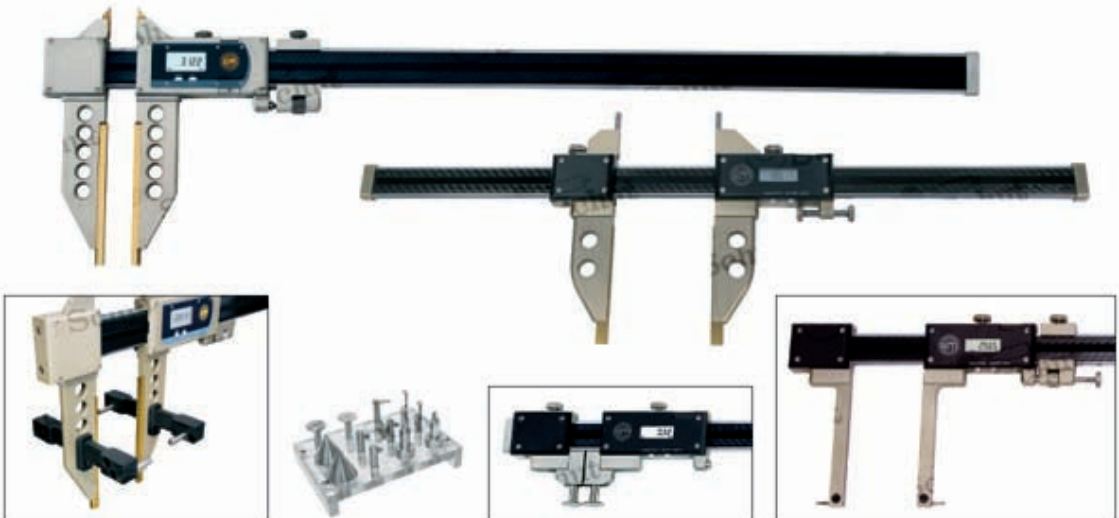

TESA TWIN-Cal digital workshop calipers IP67

New generation IP67 workshop calipers with measuring ranges up to 1000 mm, TESA TWIN-Cal, with an absolute measuring system and a “soft touch” grip. These workshop calipers have a unique connectivity concept TWIN & LINK. All TWIN-Cal workshop calipers are equipped with a data output. Connect the TESA Link Connector (or TWIN-Cap) to the TWIN-Cal for “plug and play” (wireless) data transfer. Hardened stainless steel measuring jaws, with rounded jaw ends for internal and external measurements. Available with or without measuring knives for internal or external measurements.

- Measuring range: 0- 1000 mm.
- Resolution: 0.01 mm.
- mm/inch conversion.
- Digit height: 11 mm.
- Automatic switch-off.
- Reset.
- Hold function.
- Max. measuring speed: approx. 2.5 m/s.
- Locking screw.
- Protection: IP67 (also in combination with data output cable).

- Standard supplied with data output (USB, Digimatic or wireless).
- Delivery in a case with an inspection report and a declaration of conformity.
- Power supply: 1 battery type CR2032.

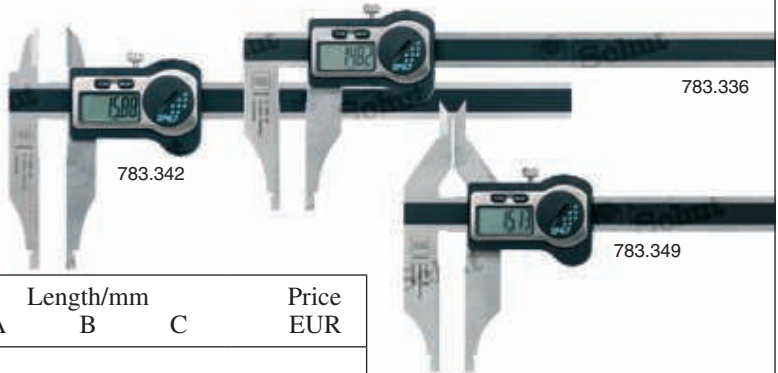

Item No.	Measuring range/mm	Length/mm			Price EUR
		A	B	C	
Without measuring knives (I):					
783.335	0- 200	5	80	–	366.00
783.336	0- 250	5	80	–	395.00
783.337	0- 300	5	90	–	416.00
783.338	0- 500	10	150	–	692.00
783.339	0- 600	10	150	–	856.00
783.340	0- 800	10	150	–	1,071.00
783.341	0- 1000	10	150	–	1,335.00
With measuring knives for external measurements (II):					
783.342	0- 200	5	80	30	392.00
783.343	0- 250	5	80	37	425.00
783.344	0- 300	5	90	37	471.00
783.345	0- 500	10	150	60	782.00
783.346	0- 600	10	150	60	967.00
783.347	0- 800	10	150	56	1,210.00
783.348	0- 1000	10	150	56	1,510.00
With measuring knives for internal measurements (III):					
783.349	0- 250	5	80	54	508.00
Options:					
495.157	Spare battery				0.50
783.301 ¹	TESA Link Connector USB				118.00
783.302 ¹	TESA Link Connector Digimatic				170.00
783.303 ¹	TESA Link Connector TWIN-Cap				159.00

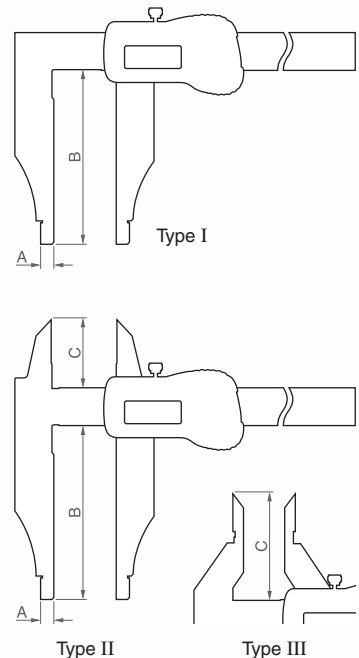

¹ The TESA Link Connector will replace the battery cover.

Mitutoyo Absolute Digimatic workshop calipers

Series large digital calipers with the unique Absolute measuring system to prevent inaccuracy because of an incorrect zero position. The one-time setting of origin remains as the absolute zero position until the battery has to be changed.

- Measuring range: 0- 1000 mm.
- Resolution: 0.01 mm.
- ABS/INC switchable.
- Digimatic data output.
- On/off switch.
- Reset.
- Max. measuring speed: any.
- With or without measuring knives.
- Locking screw.



- Types I and II with rounded jaw ends for internal measurements:
measuring range ≤ 300 mm: from 10 mm,
measuring range ≥ 450 mm: from 20 mm.
- Protection: IP40 or IP67.
- Conforms to factory standard.
- Delivery in a case.
- Power supply: 1 battery type V357.

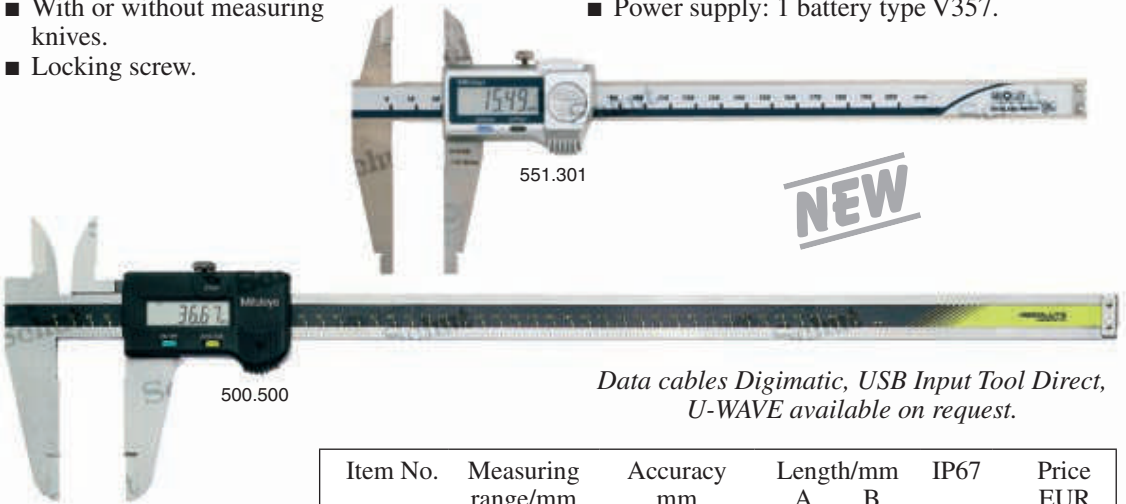

Data cables Digimatic, USB Input Tool Direct, U-WAVE available on request.

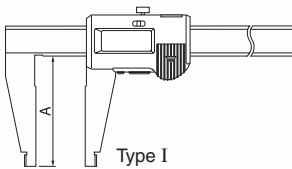

Type I

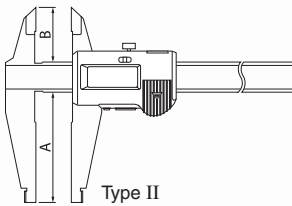

Type II

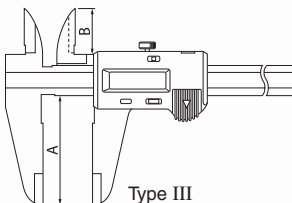

Type III

Item No.	Measuring range/mm	Accuracy mm	Length/mm A B	IP67	Price EUR
Without measuring knives (I):					
550.301 ¹	0- 200	± 0.03	60 -	IP67	344.00
550.331 ²	0- 300	± 0.04	75 -	IP67	413.00
550.203	0- 450	± 0.05	100 -	-	611.00
550.205	0- 600	± 0.05	100 -	-	691.00
550.207	0-1000	± 0.07	140 -	-	1,179.00
With measuring knives for external measurements (II):					
551.301 ¹	0- 200	± 0.03	60 30	IP67	369.00
551.331 ²	0- 300	± 0.04	90 40	IP67	411.00
551.204	0- 500	± 0.06	150 56	-	770.00
551.206	0- 750	± 0.06	150 56	-	1,061.00
551.207	0-1000	± 0.07	150 56	-	1,285.00
With measuring knives for internal measurements (III):					
500.500	0- 450	± 0.05	90 38	-	820.00
500.501	0- 600	± 0.05	90 38	-	889.00
500.502	0-1000	± 0.07	130 50	-	1,545.00
Option: 836.535 Spare battery					1.90

¹ Offset function.

² Offset and preset function.

Mitutoyo Digimatic carbon workshop calipers

Workshop calipers, with a data output, with an ultra lightweight carbon fiber construction that saves up to 50% of the total weight compared to a steel workshop caliper. Exchangeable measuring jaws for special purposes (and the necessary holders) are optionally available.

- Measuring range: 0-2000 mm, internal measurements from 20 mm.
- Resolution: 0.01 mm.
- ABS/INC switchable.
- Digimatic data output.
- On/off switch.
- Reset/preset.
- Hold function.
- Offset function for direct read-out of internal measurements.
- Max. measuring speed: any.
- Protection: IP66.
- Conforms to factory standard.
- Delivery in a case.
- Power supply: 1 battery type V357.



Data cables Digimatic, USB Input Tool Direct, U-WAVE available on request.

Item No.	Measuring range/mm	Accuracy/mm	Jaw length/mm	Weight/kg	Price EUR
With steel measuring faces:					
552.302	0- 450	±0.04	100	0.7	922.00
552.303	0- 600	±0.04	100	0.8	1,019.00
552.304	0-1000	±0.05	150	1.8	1,490.00
552.305	0-1500	±0.09	150	2.2	1,896.00
552.306	0-2000	±0.12	150	2.6	2,423.00
With ceramic measuring faces, suited for e.g. (electro)magnetic objects:					
552.155	0- 450	±0.04	100	0.7	1,383.00
552.156	0- 600	±0.04	100	0.8	1,500.00
Long measuring jaws with steel measuring faces:					
552.150	0- 450	±0.06	200	1.2	1,383.00
552.151	0- 600	±0.06	200	1.3	1,500.00
552.152	0-1000	±0.07	200	2.1	1,929.00
552.153	0-1500	±0.11	200	2.5	2,497.00
552.154	0-2000	±0.14	200	2.9	3,142.00
Options:					
836.535	Spare battery				1.90
914.055*	Measuring jaws (pair) for center distances from 10 mm				224.00
914.057*	Measuring jaws (pair) for internal groove diameters from 50 mm				257.00
914.053*	Holders (pair) for separate measuring jaws, up to measuring range 0- 600 mm				171.00
914.054*	Holders (pair) for separate measuring jaws, from measuring range 0- 1000 mm				176.00

* Not suited for use with the workshop calipers with long measuring jaws (552.150-154).

HELIOS-PREISSER universal digital calipers

Universal calipers with exchangeable measuring inserts for special purposes. All inserts with M2.5 thread can be used with these calipers. Please see the dial indicator accessories section for these inserts.

- Internal measuring range¹: 15 - 500 mm.
- External measuring range¹: 0 - 500 mm.
- Resolution: 0.01 mm.
- mm/inch conversion.
- ABS/INC switchable.
- Digimatic data output (only 836.569/570).
- On/off switch.
- Reset/preset.
- Hold function.
- Interchangeable measuring inserts:
 - 150 mm: 2 pairs included (ball $\varnothing 5$ mm and planar $\varnothing 4.8$ mm),
 - 300/500 mm: not included.
- Locking screw.
- Stainless steel construction.
- Protection: IP67 (only 836.548).
- Delivered with accurate setting standard 50 mm (only 836.548).
- Delivery in a case.
- Power supply: 1 battery type CR2032.



Item No.	Measuring range/mm internal ¹ external ¹	Jaw length mm	Jaw width mm	Weight kg	Price EUR
836.548	15 - 150 0 - 150	40	5	0.7	352.00
836.569	30 - 300 0 - 300	90	12	1.2	583.00
836.570	40 - 500 0 - 500	100	16	2.5	747.00

Options:

495.157	Spare battery	0.50
836.119	Digimatic output cable (2 m)	61.00
836.552	USB output cable (2 m) incl. software	69.00
836.571	RS232C output cable (2 m)	48.00



¹ The measuring range can change depending on inserts.

Inserts examples. For more information see the dial indicator accessories section.

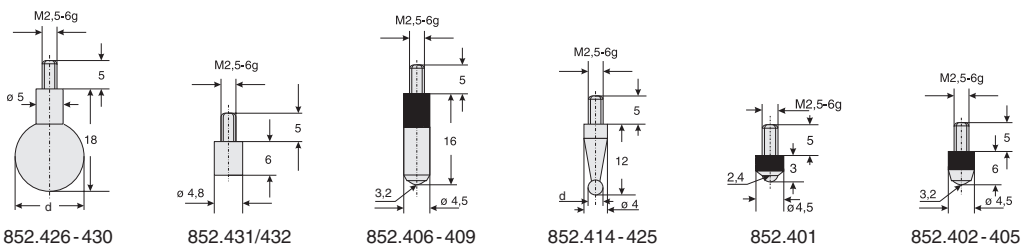

Universal digital calipers

Large universal digital calipers made of stainless steel for internal and external measurements. In combination with these universal calipers many inserts are available e.g. for measuring thread. See accessories universal digital calipers. By intake with M2.5 thread very many inserts can be used. Please see the dial indicator accessories section for these inserts.

Universal digital calipers

- Internal measuring range: 24 - 650 mm.
- External measuring range: 0 - 570 mm.
- Resolution: 0.01 mm.
- Accuracy: ± 0.02 or ± 0.03 mm.
- mm/inch conversion.
- Opto-RS232C data output.
- On/off switch.
- Reset/preset.
- Interchangeable measuring inserts.
- Many extensions and inserts available.
- Protection: IP65.
- Conforms to factory standard.
- Delivery in a case with two inserts, two insert holders and a measuring report.
- Power supply: 1 battery type CR2032.

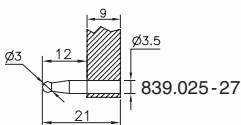
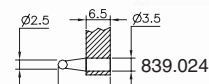

Item No.	Measuring range/mm internal external	Accuracy mm	Jaw length mm	Price EUR
839.024 ¹	24 - 250 0 - 210	± 0.02	64	697.00
839.025 ²	42 - 350 0 - 270	± 0.03	103	778.00
839.026 ²	42 - 450 0 - 370	± 0.03	103	960.00
839.027 ²	42 - 650 0 - 570	± 0.03	103	1,313.00
Options:				
495.157	Spare battery			0.50
781.887	Opto-RS232C cable 9p (2 m)			120.00

¹ Inserts 837.820 and insert holders standard included.

² Inserts 837.821 and insert holders standard included.

Also models with spring system available.

Universal digital calipers with dial indicator

- Internal measuring range: 20 - 500 mm.
- External measuring range: 0 - 430 mm.
- Resolution: 0.01 mm.
- Dial indicator: measuring range: 0 - 5 mm, graduation: 0.01 mm.
- mm/inch conversion.
- Opto-RS232C data output.
- On/off switch.
- Reset/preset.
- Interchangeable measuring inserts.
- Fine adjustment and locking screw.
- Protection: IP65.
- Conforms to factory standard.
- Delivery in a case with a dial indicator, a removable bridge, two inserts $\varnothing 3$ mm, two insert holders and a measuring report.
- Power supply: 1 battery type CR2032.

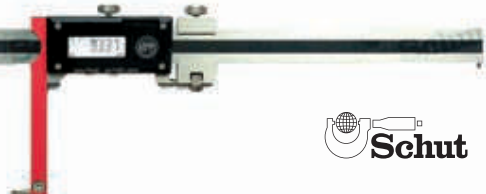
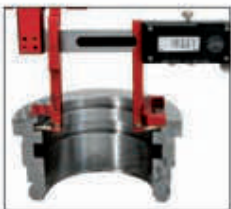

 Schut

Universal digital calipers with dial indicator (continued)

Item No.	Measuring range/mm		Accuracy mm	Jaw length mm	Holder bar length/mm	Price EUR
	internal	external				
837.816	20 - 200	0 - 138	±0.02	60	8	1,697.00
837.817	24 - 300	0 - 230	±0.02	80	10	1,919.00
837.845	24 - 500	0 - 430	±0.03	80	10	2,270.00

Options:

495.157 Spare battery	0.50
781.887 Opto-RS232C cable 9p (2 m)	120.00

Universal digital calipers accessories

Inserts for thread measurements, per pair

Pitch mm	Item No.	Price EUR	Item No.	Price EUR
	Internal meas.:		External meas.:	
0.4 - 0.5	839.010	141.00	839.018	141.00
0.6 - 0.9	839.011	141.00	839.019	141.00
1 - 1.75	839.014	141.00	839.020	141.00
2 - 3	839.015	141.00	839.021	141.00
3.5 - 5	839.016	141.00	839.022	141.00
5.5 - 7	839.017	141.00	839.023	141.00

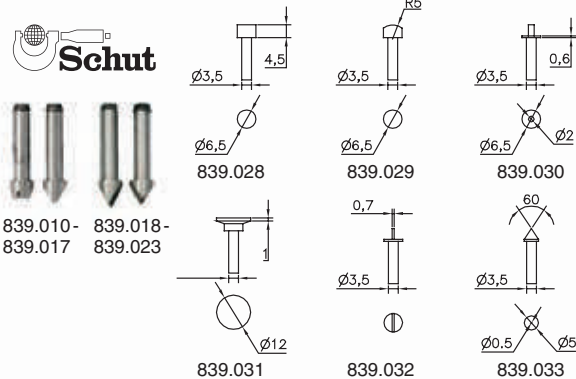

Insert holders (M2.5), per piece

Item No.	Length C/mm	Price EUR
837.832	8	22.20
837.833	10	22.20
839.054	12	38.40
839.055	20	45.00
839.056	50	66.00

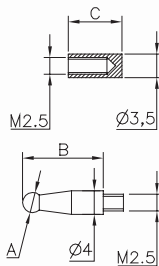

Inserts (M2.5), per pair

Diameter A/mm	Length B/mm	Item No.	Price EUR	Item No.	Price EUR
		Steel:		Tungsten carbide:	
1.5	12	837.818	48.00	839.040	106.00
2	12	837.819	48.00	839.041	106.00
2.5	12	837.820	48.00	839.042	106.00
3	12	837.821	48.00	839.043	106.00
3.5	12	837.822	48.00	839.044	106.00
4	12	837.823	48.00	839.045	106.00
4.5	12	837.824	48.00	839.046	106.00
5	12	837.825	48.00	839.047	106.00
5.5	12	837.826	48.00	839.048	106.00
6	12	837.827	48.00	839.049	106.00
6.5	12	837.828	53.00	839.050	106.00
7	18	837.829	53.00	839.051	106.00
8	18	837.830	53.00	839.052	106.00
10	18	837.831	53.00	839.053	106.00

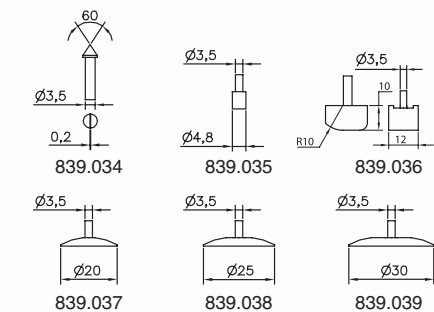

Various inserts, per piece

Item No.	Description	Price EUR
839.028	Cylindrical	89.00
839.029	Spherical	89.00
839.030	Double diameter	89.00
839.031	Disc	106.00
839.032	Flat	89.00
839.033	Conical 60°	89.00
839.034	Knife-edged 60°	89.00
839.035	Cylindrical	89.00
839.036	Flat	111.00
839.037	Disc	131.00
839.038	Disc	146.00
839.039	Disc	146.00

TESA dial calipers

Rugged dial calipers model CCMA-M and CCMA-P, out of hardened stainless steel and with patented shockproof design. Ideal for use in the workshop.

- Measuring range: 0- 300 mm.
- Graduation: 0.01 or 0.02 mm.
- Rotatable dial, \varnothing 32 mm.
- Shockproof.
- Thumb wheel (only 782.528/529).
- Hardened stainless steel construction.
- DIN 862.
- Delivery in a case with an inspection report and a declaration of conformity.

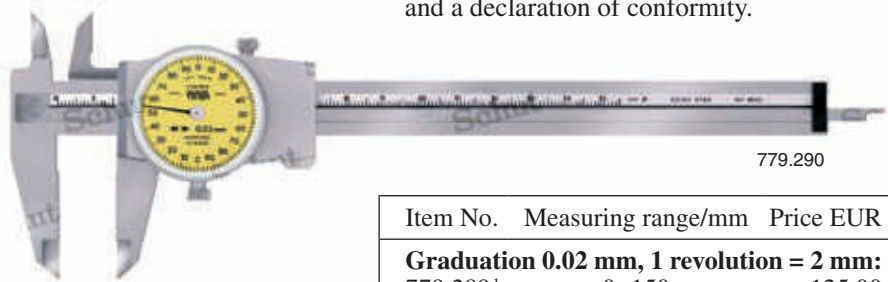

779.290



782.444



779.289

Item No.	Measuring range/mm	Price EUR
Graduation 0.02 mm, 1 revolution = 2 mm:		
779.289 ¹	0 - 150	125.00
779.290	0 - 150	125.00
782.528 ²	0 - 200	222.00
782.529 ²	0 - 300	370.00
Graduation 0.01 mm, 1 revolution = 1 mm:		
782.444	0 - 150	133.00

¹ Plastic dial housing.² With thumb wheel.

Mitutoyo dial calipers

Mitutoyo dial calipers, made of special corrosion-free steel, with hardened and lapped measuring faces and protected rack. The slider is titanium coated (except 505.745).

- Measuring range: 0- 300 mm.
- Graduation: 0.01 mm or 0.02 mm.
- Rotatable dial.
- Shockproof.
- Caliper and dial with locking screw.
- Dial indicator jewel beared.
- Conforms to factory standard.
- Delivery in a case.



505.732



NEW

Item No.	Measuring range/mm	Accuracy mm	Price EUR
Graduation 0.02 mm, 1 revolution = 2 mm:			
505.730	0 - 150	± 0.03	97.00
505.731	0 - 200	± 0.03	199.00
505.745	0 - 300	± 0.04	300.00
Graduation 0.01 mm, 1 revolution = 1 mm:			
505.732	0 - 150	± 0.02	112.00

Dial calipers

Stainless steel dial calipers with protected rack.

- Measuring range: 0 - 300 mm.
- Graduation: 0.01 or 0.02 mm.
- 1 pointer revolution = 1 or 2 mm.
- Rotatable dial.
- Thumb wheel.
- DIN 862.

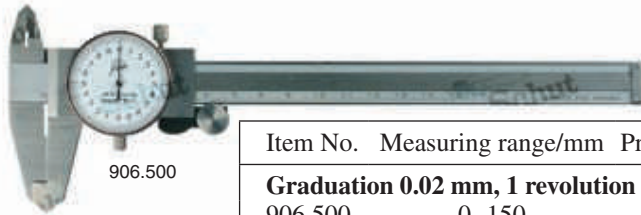

Item No.	Measuring range/mm	Price EUR
Graduation 0.02 mm, 1 revolution = 2 mm:		
906.500	0 - 150	30.00
906.499	0 - 200	49.00
906.501	0 - 300	62.00
Graduation 0.01 mm, 1 revolution = 1 mm:		
906.498	0 - 150	34.30



High-quality plastic calipers from Switzerland

These modern designed Swiss calipers are made of fiberglass re-enforced plastic, which makes them very firm and light, wear-proof, and resistant to all kinds of chemicals – ideal for the workshop! Each model is equipped with an easy read-out. Combined with the low price a line of very attractive calipers.

For 100 pieces or more the calipers and folding rules are available with prints. This gives you the opportunity to promote your company name or logo in an easy way and is within your own company, as well when used as a business gift, an outstanding marker. For more information about the printing possibilities please contact our sales department.

- Measuring range: 0 - 150 mm.
- Accuracy: $\pm(0.1 + 0.001L)$ mm (L in mm).
- Thumb wheel.
- Delivery in a case.

Vernier caliper

- Vernier: 0.1 mm / 1/64 inch.
- The scale lightens up with minimal light.

Dial caliper

- Graduation: 0.1 mm.
- 1 pointer revolution = 10 mm.
- Rotatable dial, $\varnothing 32$ mm.
- The dial is shockproof and can be set to zero.

Digital caliper

- Resolution: 0.01 mm.
- mm/inch conversion.
- On/reset switch.
- Off switch.
- Power supply: 1 battery type V357.



837.209:
set with folding
rule of 1 m

Item No.	Description	Price EUR
837.207	Vernier caliper	12.40
837.205	Dial caliper	18.60
837.209	Set of dial caliper 837.205 with a folding rule of 1 m	21.60
837.201	Digital caliper	55.00
Option:		
836.535	Spare battery	1.90

Calipers

Hardened stainless steel calipers with no-glare chrome finished scale and vernier.

- Measuring range: 0- 300 mm.
- Vernier: 0.05 or 0.02 mm.
- Raised sliders (except 909.538).
- Monoblock.
- Locking screw or spring release.
- Flat depth rod.
- Thread table on the back side.
- DIN 862.
- Delivery in a case.

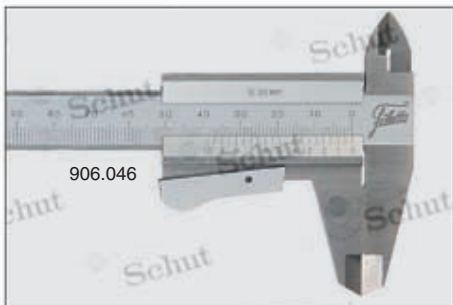
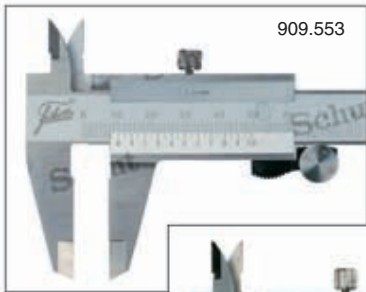
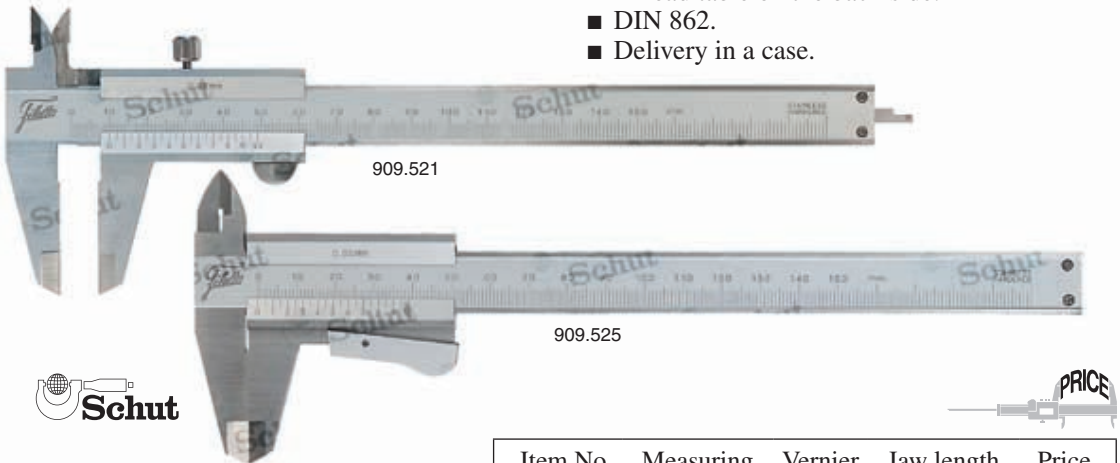

Item No.	Measuring range/mm	Vernier mm	Jaw length mm	Price EUR
Locking screw on top:				
909.541	0- 150	0.02	40	14.20
909.542	0- 160	0.02	40	14.80
909.543	0- 200	0.02	50	19.40
909.544	0- 300	0.02	62	37.10
Locking screw on top:				
909.520	0- 100	0.05	30	12.20
909.521	0- 150	0.05	40	13.90
909.522	0- 160	0.05	40	15.60
909.523	0- 200	0.05	50	18.80
909.524	0- 300	0.05	62	35.20
With thumb wheel (locking screw on top):				
909.553	0- 150	0.05	40	16.00
909.554	0- 200	0.05	50	21.40
909.555	0- 300	0.05	62	40.00
Parallax-free (locking screw on top):				
909.538	0- 150	0.05	40	26.40
Spring release:				
909.525	0- 150	0.05	40	14.30
909.526	0- 160	0.05	40	14.80
909.527	0- 200	0.05	50	18.80
909.528	0- 300	0.05	62	35.20
Spring release, left-handed model:				
906.046	0- 150	0.05	40	20.90
906.047	0- 150	0.02	40	22.30

Mitutoyo calipers

Mitutoyo calipers suitable for outside, inside, height and depth measurements. Measuring jaws and knives with beveled measuring faces for measuring small grooves and bores.

- Measuring range: 0- 300 mm.
- Vernier: 0.05 mm / 1/128 inch or 0.02 mm.
- Flat depth rod (except 530.102: round depth rod \varnothing 1.9 mm).
- Raised sliders.
- Thread table on the back side (only 531.122/530.316).
- No-glare chrome finished scale and vernier.
- Lapped, hardened steel measuring faces.
- Tungsten carbide outside measuring jaws (only 530.320/335).
- Tungsten carbide inside measuring jaws (only 530.335).

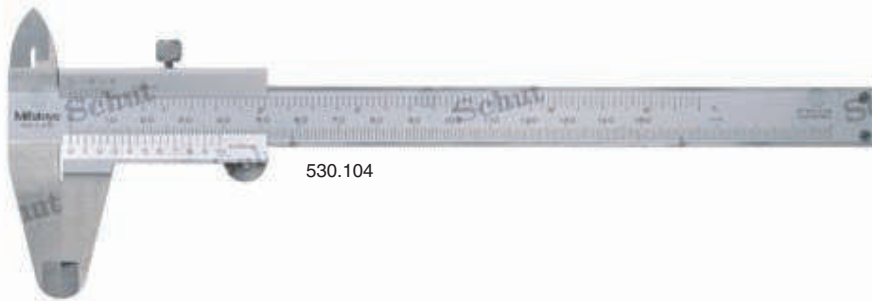

530.104

NEW



531.122



Item No.	Measuring range/mm	Vernier mm	Jaw length mm	Price EUR
Locking screw on top:				
530.122 ¹	0- 150	0.02	40	35.00
530.123 ¹	0- 200	0.02	50	58.00
530.124 ¹	0- 300	0.02	64	182.00
Locking screw on top:				
530.104	0- 150	0.05	40	29.00
530.114	0- 200	0.05	50	75.00
530.115	0- 300	0.05	64	182.00
Locking screw on top:				
530.102 ¹	0- 150	0.05	40	45.00
530.101 ¹	0- 150	0.05	40	29.00
Locking screw on top:				
530.320 ¹	0- 150	0.05	40	117.00
Locking screw on top:				
530.335 ¹	0- 150	0.05	40	186.00
Locking screw on the bottom-side:				
530.316	0- 150	0.05	40	47.00
Spring release:				
531.122	0- 150	0.05	40	36.00
531.108	0- 200	0.05	50	87.00
531.109	0- 300	0.05	64	199.00

¹ Without inch graduation.

TESA calipers

Swiss high-precision stainless steel caliper with no-glare chrome finished scale and vernier.

- Measuring range: 0-300 mm.
- Vernier: 0.02 mm, 0.05 mm or 0.05 mm / 1/128 inch.
- Locking screw.
- Round ($\varnothing 1.5$ mm) or flat (1.5-2 mm) depth rod.
- DIN 862.
- Delivery in a case with an inspection report and a declaration of conformity.

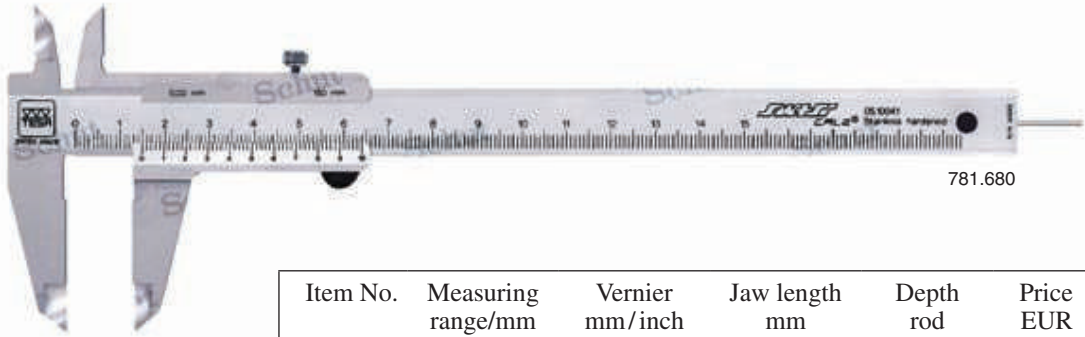

781.680



783.276

Item No.	Measuring range/mm	Vernier mm/inch	Jaw length mm	Depth rod	Price EUR
With mm graduation:					
781.680	0-150	0.02	40	round	60.00
783.275	0-150	0.05	40	round	60.00
With mm/inch graduation:					
783.276	0-150	0.05/1/128	40	round	65.00
783.277	0-200	0.05/1/128	50	flat	95.00
783.278	0-300	0.05/1/128	64	-	180.00

TESA calipers with outside angled measuring jaws

Specially designed for measuring bore and internal groove diameters, e.g. on internal safety rings.

- Measuring range: 10-200 mm.
- Vernier: 0.05 mm.
- Locking screw.
- Hardened stainless steel construction.
- Conforms to factory standard.
- Delivery in a case with a declaration of conformity.

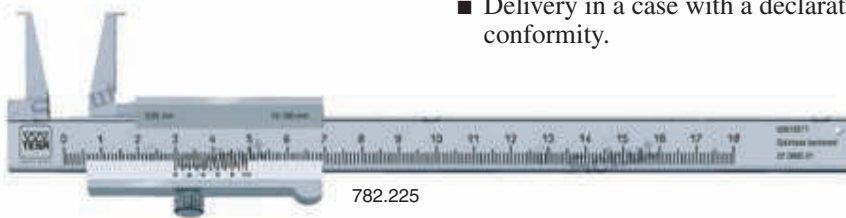

782.225

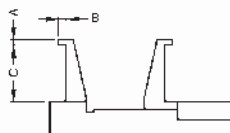

Item No.	Measuring range/mm	Length/mm			Price EUR
		A	B	C	
782.225	10-160	0.9	3	25	190.00
782.226	20-160	2	5	40	270.00
782.227	26-200	3	7	60	349.00

Workshop calipers

Hardened stainless steel workshop calipers with no-glare chrome finished scale and vernier.

- Measuring range: 0- 1500 mm.
- Vernier: 0.02 mm.
- Raised sliders.
- Fine adjustment.
- With measuring knives or rounded jaw ends for internal measurements.
- Locking screws.
- DIN 862.
- Delivery in a case.



906.230

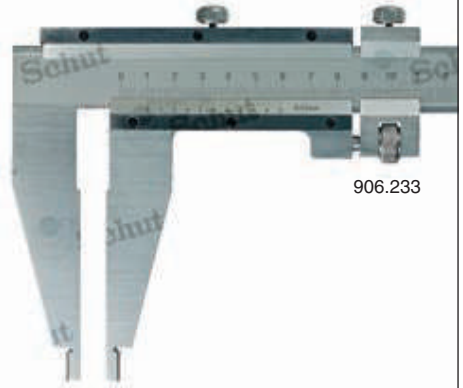

906.233



Item No.	Measuring range mm	Internal measurements from/mm	Jaw length mm	Price EUR
With measuring knives for internal measurements:				
906.230	0- 300	-	65	54.00
With rounded jaw ends for internal measurements:				
906.231	0- 300	10	80	69.00
906.233	0- 500	10	100	84.00
906.234	0- 600	10	100	86.00
906.235	0-1000	20	125	301.00
906.236	0-1500	20	125	672.00

Workshop calipers with extended jaw lengths

Hardened stainless steel workshop calipers with no-glare chrome finished scale and vernier.

- Measuring range: 0-300 mm.
- Vernier: 0.05 mm / 1/128 inch.
- Raised sliders.
- With or without fine adjustment.
- Measuring knives for external measurements.
- Rounded jaw ends for internal measurements from 10 mm.
- DIN 862.
- Delivery in a case.

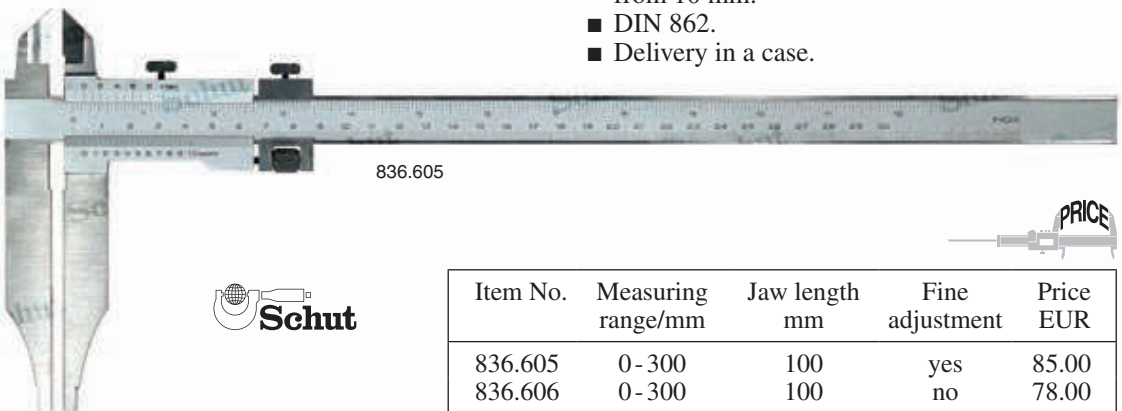

836.605



Item No.	Measuring range/mm	Jaw length mm	Fine adjustment	Price EUR
836.605	0-300	100	yes	85.00
836.606	0-300	100	no	78.00

Workshop calipers

Large and solid, stainless steel calipers with no-glare chrome finished scale and vernier.

- Measuring range: 0-2000 mm.
- Vernier: 0.02 mm / 1/1000 inch or 0.05 mm / 1/128 inch.
- Fine adjustment.
- With or without measuring knives for internal or external measurements.
- Monoblock.
- Rounded jaw ends for internal measurements; measuring range ≤ 600 mm: $K=10$ mm, measuring range >600 mm: $K=20$ mm.
- DIN 862.
- Delivery in a case with a declaration of conformity.

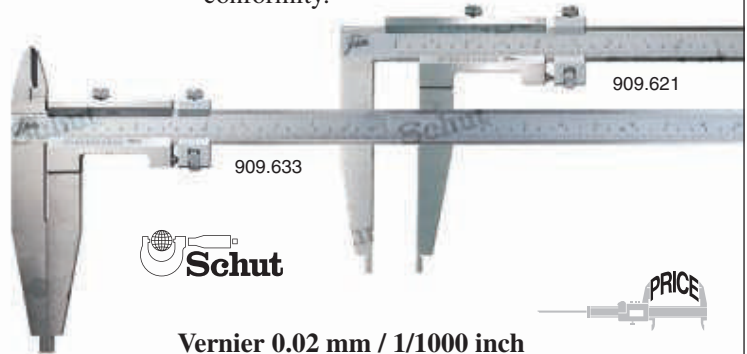
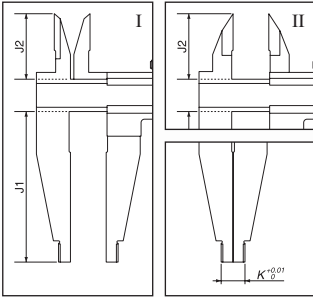

Vernier 0.05 mm / 1/128 inch

Item No.	Measuring range mm	Length mm			Price EUR
		J1	J2	K	
Without measuring knives:					
909.670	0- 300	90	-	10	83.00
909.620	0- 450	150	-	10	151.00
909.621	0- 500	150	-	10	163.00
909.622	0- 600	150	-	10	175.00
909.623	0- 800	150	-	20	288.00
909.624	0-1000	150	-	20	349.00
909.639	0-1500	200	-	20	872.00
909.640	0-2000	200	-	20	1,188.00
Meas. knives for internal measurements (I):					
909.672	0- 300	90	22	10	112.00
909.632	0- 400	100	46	10	157.00
909.633	0- 500	150	46	10	234.00
909.634	0- 600	150	46	10	280.00
909.635	0- 750	150	54	20	433.00
909.636	0-1000	150	54	20	505.00
909.637	0-1500	200	66	20	1,196.00
909.638	0-2000	200	66	20	1,453.00
Meas. knives for external measurements (II):					
909.674	0- 300	90	22	10	118.00
909.656	0- 400	100	46	10	165.00
909.657	0- 500	150	46	10	247.00
909.658	0- 600	150	46	10	294.00
909.659	0- 750	150	54	20	455.00
909.660	0-1000	150	54	20	530.00
909.661	0-1500	200	66	20	1,255.00
909.662	0-2000	200	66	20	1,526.00

Vernier 0.02 mm / 1/1000 inch

Item No.	Measuring range mm	Length mm			Price EUR
		J1	J2	K	
Without measuring knives:					
909.671	0- 300	90	-	10	83.00
909.615	0- 450	150	-	10	151.00
909.616	0- 500	150	-	10	163.00
909.617	0- 600	150	-	10	175.00
909.618	0- 800	150	-	20	288.00
909.619	0-1000	150	-	20	349.00
909.641	0-1500	200	-	20	872.00
909.642	0-2000	200	-	20	1,188.00
Meas. knives for internal measurements (I):					
909.673	0- 300	90	22	10	112.00
909.625	0- 400	100	46	10	165.00
909.626	0- 500	150	46	10	234.00
909.627	0- 600	150	46	10	280.00
909.628	0- 750	150	55	20	433.00
909.629	0-1000	150	55	20	505.00
909.630	0-1500	200	66	20	1,196.00
909.631	0-2000	200	66	20	1,453.00
Meas. knives for external measurements (II):					
909.675	0- 300	90	22	10	118.00
909.663	0- 400	100	46	10	165.00
909.664	0- 500	150	46	10	246.00
909.665	0- 600	150	46	10	294.00
909.666	0- 750	150	55	20	455.00
909.667	0-1000	150	55	20	530.00
909.668	0-1500	200	66	20	1,255.00
909.669	0-2000	200	66	20	1,526.00



HELIOS-PREISSER workshop calipers

Large and solid, stainless steel calipers with no-glare chrome finished scale and vernier. The calipers with a measuring range up to 300 mm have a mm/inch graduation, those with a measuring range of 400 mm and more only have a metric graduation.

- Measuring range: 0- 1000 mm.
- Vernier: 0.05 mm / 1/128 inch.
- Rounded jaw ends for internal measurements.
- With or without fine adjustment.
- With or without measuring knives for external measurements.
- DIN 862.
- Delivery with an inspection report.
- Case available on request.



Without measuring knives

Item No.	Measuring range/mm	Jaw length mm	Price EUR
Without fine adjustment:			
836.360	0- 200	80	103.00
836.361	0- 300	90	140.00
836.362	0- 400	125	297.00
836.363	0- 500	150	391.00
836.364	0- 600	150	467.00
836.365	0- 800	150	484.00
836.367	0-1000	150	604.00
With fine adjustment:			
836.380	0- 200	80	127.00
836.381	0- 300	90	167.00
836.382	0- 400	125	347.00
836.383	0- 500	150	439.00
836.384	0- 600	150	514.00
836.385	0- 800	150	544.00
836.386	0-1000	150	665.00

With meas. knives for external measurements

Item No.	Measuring range/mm	Jaw length mm	Price EUR
Without fine adjustment:			
836.370	0- 200	80	124.00
836.371	0- 300	90	157.00
836.372	0- 400	125	364.00
836.373	0- 500	150	469.00
836.374	0- 600	150	532.00
836.375	0- 800	150	603.00
836.376	0-1000	150	724.00
With fine adjustment:			
836.390	0- 200	80	141.00
836.391	0- 300	90	181.00
836.392	0- 400	125	412.00
836.393	0- 500	150	507.00
836.394	0- 600	150	577.00
836.395	0- 800	150	664.00
836.396	0-1000	150	784.00

Probe set for calipers

This probe set enlarges the possibilities of a regular caliper. Probe holders are slid on the measuring jaw of the caliper. The different probes can be screwed onto them. The probe set makes it possible to execute measurements which are not possible with a regular caliper, such as measuring internal grooves and center distances.

- Maximum jaw thickness: 3.2 mm.
- Delivery in a wooden case.



The set consists of:

- ① right probe holder,
- ② left probe holder,
- ③ pair of disc probes $\varnothing 6$ mm,
- ④ pair of disc probes $\varnothing 10$ mm,
- ⑤ pair of disc probes $\varnothing 12.5$ mm,
- ⑥ pair of cone probes $\varnothing 9$ mm, 60° ,
- ⑦ pair of cone probes $\varnothing 12.5$ mm, 60° ,
- ⑧ pair of cylindrical probes $\varnothing 1.5 \times 9$ mm,
- ⑨ hexagon key.

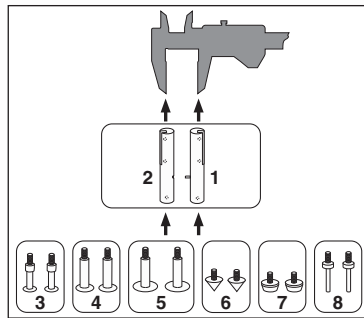

Item No.	Description	Price EUR
909.655	Probe set for calipers	55.00

\varnothing		
6 mm	>16 mm	>4 mm
10 mm	>20 mm	>1 mm
12.5 mm	>22 mm	>0 mm

3, 4, 5
Disc probes for internal measurements.

6
Conical probes (9 mm) for measuring center distances of two equal holes.

7
Conical probes (12.5 mm) for measuring center distances of two equal holes.

8
Horizontally positioned cylindrical probes for measuring internal grooves > 45 mm.

8
Vertically positioned cylindrical probes.

Caliper inspection set

For checking the accuracy of DIN 862 calipers. The set consists of three special steel gauge blocks (30 mm, 41.3 mm and 131.4 mm, ISO 3650 class 1), two steel setting rings (ø4 mm and ø25 mm) and a pair of gloves.



Item No.	Description	Price EUR
909.347	Caliper inspection set	237.00

Depth measuring base for calipers

Universal depth measuring base for stable and accurate depth measurements. Suitable for most of the calipers with a depth rod and a measuring range up to 200 mm. For more information please contact our sales department.

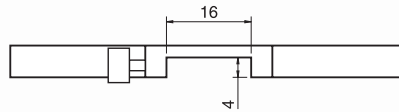

Item No.	Measuring face l x w/mm	Price EUR
909.156	75 x 6	13.60

Depth measuring bases for calipers

Universal depth measuring bases for stable and accurate depth measurements. Suitable for most of the calipers with a depth rod and a measuring range up to 200 mm. For more information please contact our sales department.



909.386

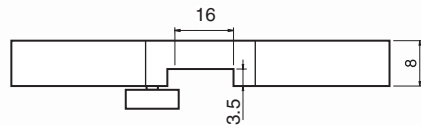

Item No.	Measuring face l x w/mm	Price EUR
909.386	80 x 8	16.60
909.387	100 x 8	18.50



Mitutoyo caliper inspection set

For checking the accuracy of DIN 862 calipers.

The set consists of three special steel gauge blocks (30 mm, 41.3 mm and 131.4 mm, ISO 3650 class 1), two steel setting rings (ø4 mm and ø25 mm) and a pair of gloves.

- Delivery in a case with a manufacturer's certificate for the gauge blocks.



Item No.	Description	Price EUR
516.124	Caliper inspection set	815.00

TESA depth measuring base for calipers

Suitable for most of the TESA calipers with a depth rod and measuring range 150 mm.

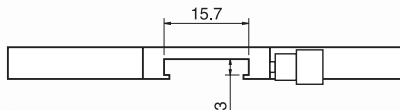

Item No.	Measuring face l x w/mm	Price EUR
779.362	75 x 6	33.00

Mitutoyo depth measuring bases for calipers

Universal depth measuring bases for stable and accurate depth measurements. Suitable for most of the calipers with a depth rod and a measuring range up to 200 mm.

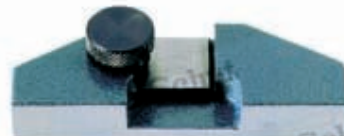
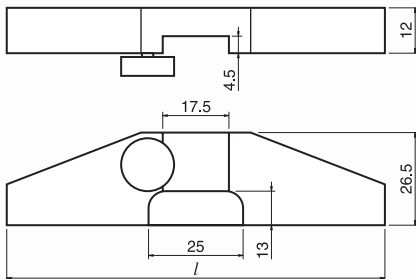

150.083



150.084



Item No.	Measuring face l x w/mm	Price EUR
150.083	75 x 12	47.00
150.084	100 x 12	52.00

Soft cases for calipers

Protect calipers during transport and storage.

- For regular shaped calipers (analog, digital and dial type).

- Made of synthetic leather.



Item No.	For meas. range/mm	Price EUR
909.494	100	2.60
909.495	150	3.30
909.496	160	3.70
909.497	200	5.40
909.498	300	7.40

Digital protractor

Compact digital protractor to attach to a caliper or height gauge.

- Measuring range: 180°.
- Resolution: 0.01° or 1'.
- Accuracy: ±5'.
- Digimatic data output.
- On/off switch.
- Automatic switch-off (adjustable).
- Preset or hold function.
- Reset.
- Reversible measuring direction.
- Weight: 160 g.
- Delivery in a case including assembly key, mounting bracket (clamping shaft 9 x 9 mm) and clamping screw for height gauge.
- Power supply: 2 batteries type AAA.



Item No.	Description	Price EUR
855.803	Digital protractor	457.00
Options:		
497.914	Spare battery (2 needed)	0.40
905.338	Digimatic cable, 1 m	30.00
905.409	Digimatic cable, 2 m	36.00

Measuring instruments set

- Caliper 0- 150 mm, vernier 0.02 mm.
- Micrometer 0- 25 mm, graduation 0.01 mm.
- Precision square 100 x 70 mm.
- Ruler 0- 150 mm.
- Adjustment tool.



Item No.	Description	Price EUR
906.176	Meas. instruments set	59.00



Depth calipers

- Measuring range: 0 - 500 mm.
- Analog: vernier 0.02 mm, digital: resolution 0.01 mm.
- With or without hook (8 x 3 mm, l x w).
- Locking screw.

Analog

- Stainless steel construction.
- No-glare chrome finished scale and vernier.

Digital

- mm/inch conversion.
- On and off switches.
- Reset.
- Power supply: 1 battery type V357.

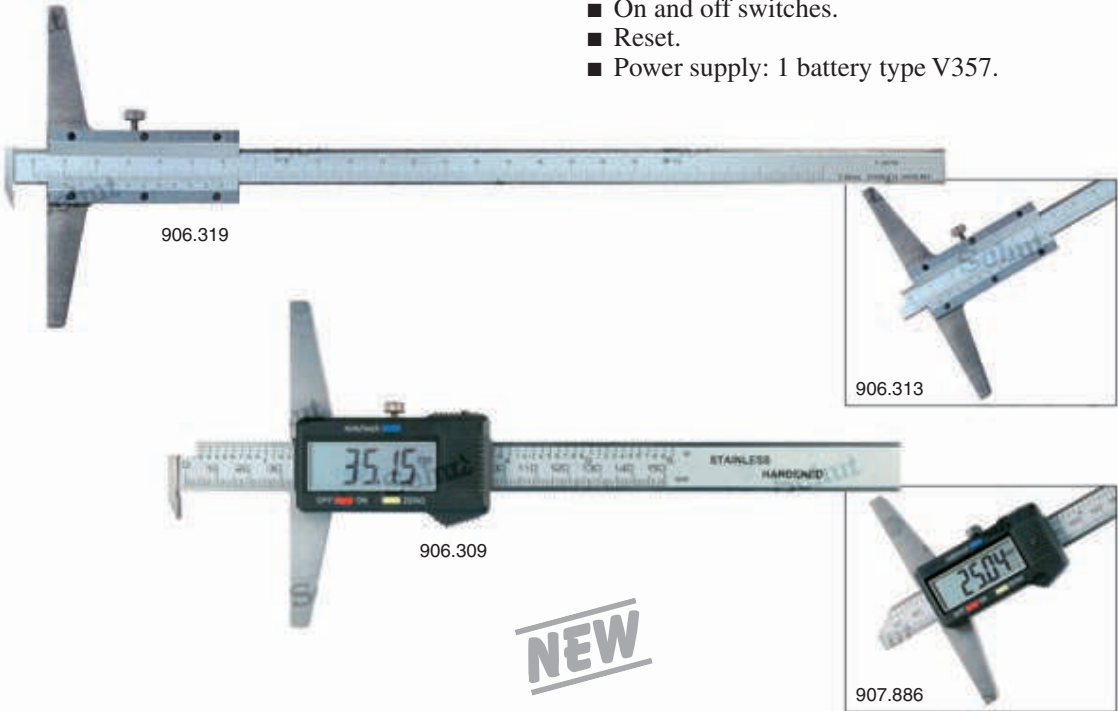

Analog

Item No.	Measuring range/mm	Base length/mm	Price EUR
Without hook:			
906.314	0 - 150	100	32.50
906.313	0 - 200	100	32.50
906.315	0 - 300	100	35.80
906.317	0 - 500	100	54.00
With hook:			
906.318	0 - 150	100	33.50
906.319	0 - 200	100	33.50
906.321	0 - 300	100	36.90
906.322	0 - 500	100	61.00

Digital

Item No.	Measuring range/mm	Base length/mm	Price EUR
Without hook:			
907.886	0 - 150	100	45.00
907.887	0 - 200	100	45.00
907.888	0 - 300	100	58.00
907.898	0 - 500	100	99.00
With hook:			
906.309	0 - 150	100	47.00
906.310	0 - 200	100	47.00
906.311	0 - 300	100	60.00
906.312	0 - 500	100	101.00
Option:			
836.535	Spare battery		1.90



Depth calipers

Depth calipers with or without hook.

- Measuring range: 0 - 300 mm.
- Vernier: 0.05 mm.
- No-glare chrome finished scale and vernier.
- Monoblock.
- Stainless steel construction.
- DIN 862.
- Larger measuring ranges available on request.

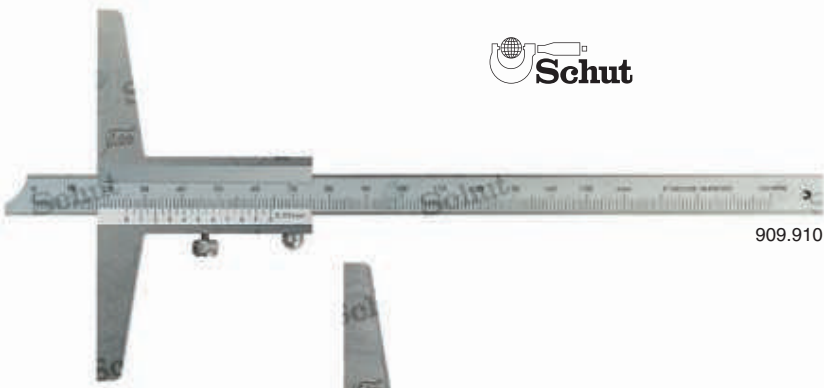

909.910



909.916

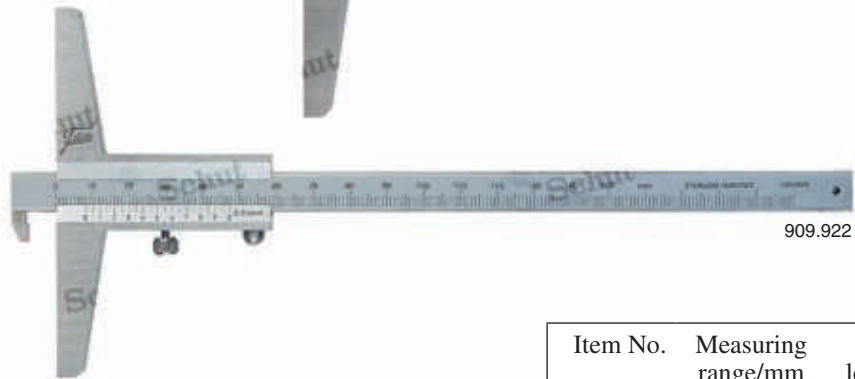

909.922

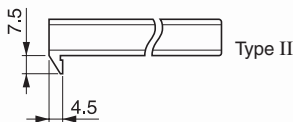
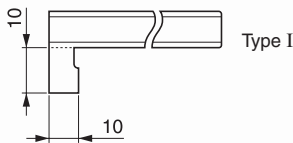

Item No.	Measuring range/mm	Base length/mm	Price EUR
Without hook:			
909.910	0 - 150	100	29.20
909.911	0 - 200	100	39.80
909.912	0 - 300	100	52.00
With hook (type I):			
909.916	0 - 150	100	45.00
909.917	0 - 200	100	57.00
909.918	0 - 300	100	87.00
With hook (type II):			
909.922	0 - 150	100	45.00
909.923	0 - 200	100	57.00
909.924	0 - 300	100	87.00

HELIOS-PREISSER depth calipers

Depth calipers with or without hook. The models with a hook have graduations on both sides of the scale, allowing reversed usage (i.e. without hook) of the instrument.

- Measuring range: 0- 1000 mm.
- Vernier: 0.05 mm.
- No-glare chrome finished vernier.
- DIN 862.
- Length (l) and width (w) of the hook at a scale cross-section of
 - 8 x 3 mm: 12 x 5 mm,
 - 12 x 4 mm: 16 x 10 mm,
 - 20 x 5 mm: 50 x 19 mm.

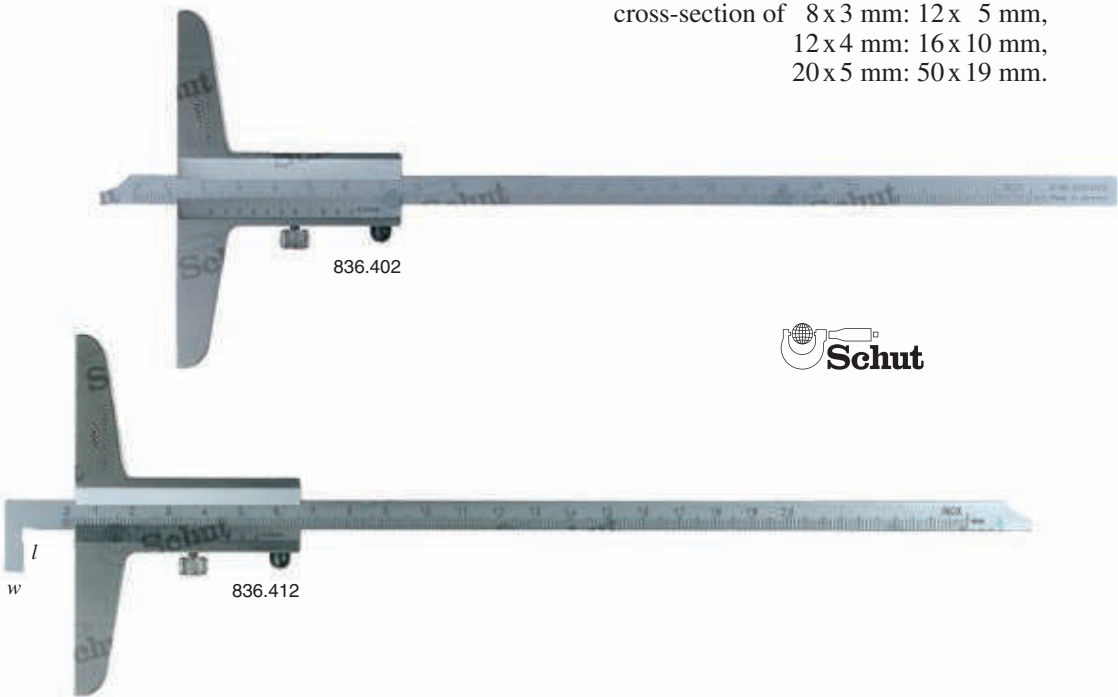

Stainless steel

Item No.	Meas. range mm	Base length mm	Cross-section scale/mm	Price EUR
Without hook:				
836.622	0- 200	100	8 x 3	71.00
836.623	0- 300	150	12 x 4	86.00
836.621	0- 500	150	12 x 4	133.00
836.624	0- 500	250	20 x 5	205.00
836.625	0- 800	250	20 x 5	338.00
836.626	0-1000	250	20 x 5	480.00
With hook:				
836.627	0- 200	100	8 x 3	84.00
836.608	0- 300	150	12 x 4	102.00
836.628	0- 500	150	12 x 4	160.00
836.629	0- 500	250	20 x 5	268.00
836.636	0- 800	250	20 x 5	737.00
836.631	0-1000	250	20 x 5	583.00

Stainless steel, no-glare chrome finished scale

Item No.	Meas. range mm	Base length mm	Cross-section scale/mm	Price EUR
Without hook:				
836.402	0- 200	100	8 x 3	79.00
836.403	0- 300	150	12 x 4	95.00
836.404	0- 500	150	12 x 4	146.00
836.405	0- 500	250	20 x 5	223.00
836.407	0- 800	250	20 x 5	371.00
836.410	0-1000	250	20 x 5	526.00
With hook:				
836.412	0- 200	100	8 x 3	90.00
836.413	0- 300	150	12 x 4	110.00
836.414	0- 500	150	12 x 4	177.00
836.415	0- 500	250	20 x 5	372.00
836.417	0- 800	250	20 x 5	502.00
836.420	0-1000	250	20 x 5	639.00

TESA TWIN-Cal digital depth calipers IP67

New generation IP67 depth calipers, TESA TWIN-Cal, with an absolute measuring system and a “soft touch” grip. These depth calipers have a unique connectivity concept TWIN & LINK. All TWIN-Cal depth calipers are equipped with a data output. Connect the TESA Link Connector (or TWIN-Cap) to the TWIN-Cal for “plug and play” (wireless) data transfer. Waterproof, hardened stainless steel depth calipers, in different versions of the beam’s measuring face. Suited for use with removable bridges. There is also a small depth gauge available.

- Measuring range: 0 - 500 mm.
- Resolution: 0.01 mm.
- mm/inch conversion.
- Digit height: 11 mm.
- Automatic switch-off.
- Reset.
- Max. measuring speed: approx. 2.5 m/s.
- Locking screw.
- Protection: IP67 (also in combination with data output cable).
- Standard supplied with data output (USB, Digimatic or wireless).
- Delivery in a case with an inspection report and a declaration of conformity.
- Power supply: 1 battery type CR2032.

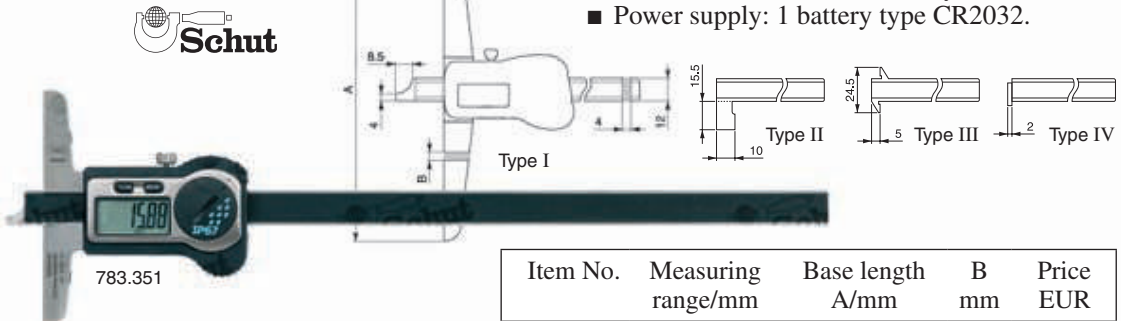

Removable bridges*

Item No.	Meas. face l x w/mm	Height h/mm	Price EUR
782.886	200 x 8	10±0.005	182.00
782.949	300 x 8	16±0.005	196.00
782.887	400 x 8	16±0.005	215.00

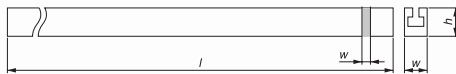

* Delivery in a case with clamp device and a declaration of conformity. Conforming to factory standard. Not suited for use with 783.360.

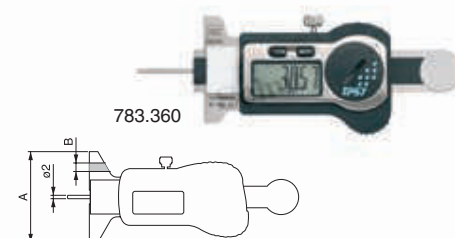

Item No.	Measuring range/mm	Base length A/mm	B mm	Price EUR
Short cut measuring face (I):				
783.350	0 - 200	100	8	417.00
783.351	0 - 250	100	8	438.00
783.352	0 - 300	150	8	462.00
783.353	0 - 500	150	8	571.00
Measuring face with one hook (II):				
783.354	0 - 300	150	8	534.00
783.355	0 - 500	150	8	629.00
Measuring face with two hooks (III):				
783.356	0 - 300	150	8	667.00
Measuring face with rotary stop (IV):				
783.357	0 - 250	100	8.5	475.00
783.358	0 - 350	100	8.5	525.00
783.359	0 - 500	150	8.5	658.00
Small depth gauge with steel depth rod:				
783.360	0 - 25	50	7.4	332.00
Options:				
495.157	Spare battery			0.50
783.301 ¹	TESA Link Connector USB			118.00
783.302 ¹	TESA Link Connector Digimatic			170.00
783.303 ¹	TESA Link Connector TWIN-Cap			159.00

¹ The TESA Link Connector will replace the battery cover.

TESA depth calipers

Hardened stainless steel depth calipers with no-glare chrome finished scale and vernier. Reduced scale section for easy access to difficult measuring points. The main scale is slightly set back for wear protection. Suited for use with removable bridges. Authentic Swiss made product.

- Measuring range: 0-600 mm.
- Vernier: 0.02 or 0.05 mm.

- DIN 862.
- Delivery in a case with an inspection report and a declaration of conformity.

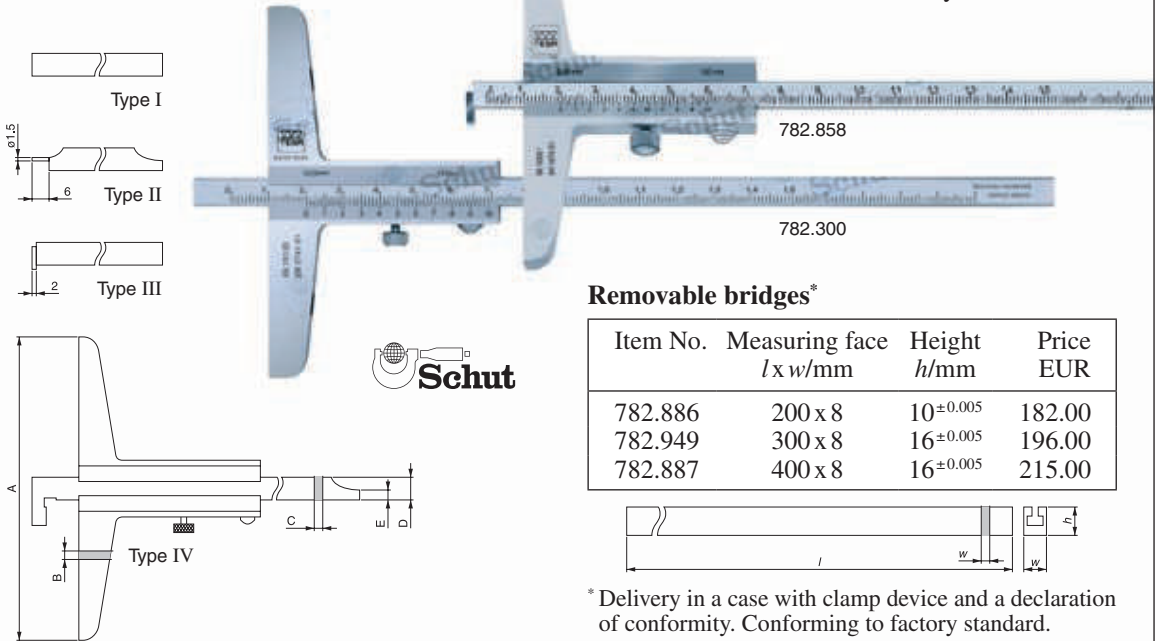

Removable bridges*

Item No.	Measuring face <i>l</i> x <i>w</i> /mm	Height <i>h</i> /mm	Price EUR
782.886	200 x 8	10 \pm 0.005	182.00
782.949	300 x 8	16 \pm 0.005	196.00
782.887	400 x 8	16 \pm 0.005	215.00

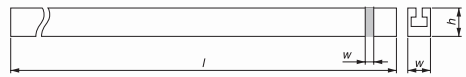

* Delivery in a case with clamp device and a declaration of conformity. Conforming to factory standard.

Measuring range/mm	Base length <i>A</i> /mm	Dimensions/mm				Vernier 0.05 mm		Vernier 0.02 mm	
		B	C	D	E	Item No.	Price EUR	Item No.	Price EUR
Flat measuring face (I):									
0 - 150	100	7.5	3	8	–	782.872	85.00	782.300	85.00
0 - 250	100	7.5	3	8	–	–	–	782.301	110.00
0 - 500	100	8.5	4	12	–	782.873	302.00	782.302	220.00
0 - 600	150	8.5	4	12	–	–	–	782.303	280.00
Convertible models with a steel tip and a short cut measuring face (II):									
0 - 150	100	7.5	3	8	3.5	782.304	120.00	782.870	120.00
0 - 250	100	7.5	3	8	4	–	–	782.305	180.00
Measuring face with rotary stop (III):									
0 - 150	130	8.5	4	12	–	782.858	190.00	782.306	190.00
0 - 250	130	8.5	4	12	–	782.876	292.00	782.307	210.00
0 - 500	130	8.5	4	12	–	–	–	782.308	290.00
Convertible models with a hook and a short cut measuring face (IV):									
0 - 150	100	7.5	3	8	3.5	–	–	782.878	170.00
0 - 250	130	8.5	4	12	4	–	–	782.880	200.00
0 - 300	150	8.5	4	12	4	–	–	782.882	230.00
0 - 500	150	8.5	4	12	4	–	–	782.884	290.00

Depth calipers

Waterproof, hardened stainless steel depth calipers, in different versions of the beam's measuring face. Suited for use with removable bridges.

- Measuring range: 0-800 mm.
- Resolution: 0.01 mm.
- Accuracy: ± 0.03 mm or ± 0.04 mm.
- On/off switch.
- Automatic switch-off.
- Reset/preset.
- Hold function.
- Locking screw.
- Protection: IP67.
- Standard supplied with insert 839.077.
- Conforms to factory standard.
- Delivery in a case with an inspection report.
- Power supply: 1 battery type CR2032.



Removable bridges

Item No.	Length/mm	Price EUR
839.074	400	372.00
839.075	500	429.00
839.076	600	556.00

Item No.	Measuring range/mm	Accuracy mm	Price EUR
839.069	0-300	± 0.03	692.00
839.070	0-400	± 0.03	798.00
839.071	0-500	± 0.03	939.00
839.072	0-600	± 0.03	1,040.00
839.073	0-800	± 0.04	1,515.00
Option:			
495.157	Spare battery		0.50

Inserts

Item No.	Description	Price EUR
839.077	Insert	111.00
839.079	Insert	111.00
839.080	Insert	111.00
839.081	Insert	111.00
839.082	Insert	111.00
839.083	Insert	111.00
839.078	Insert	152.00

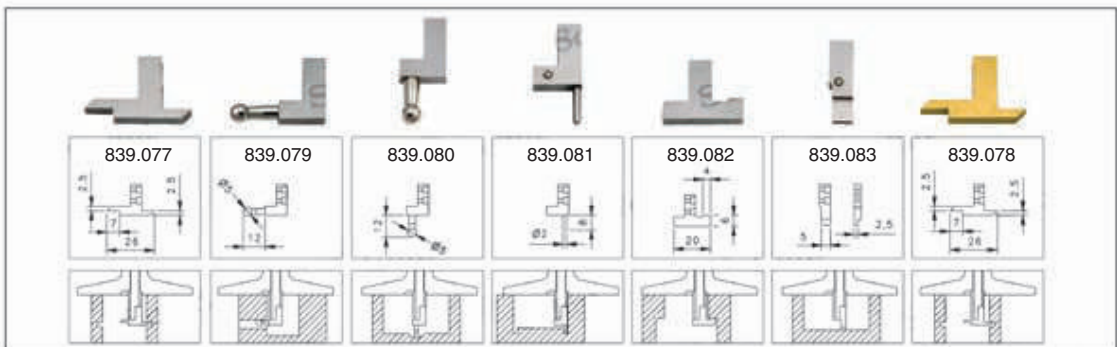

Mitutoyo Absolute Digimatic depth calipers

Mitutoyo depth calipers with the Absolute system. For use in workshop conditions, Mitutoyo has also developed *Coolant Proof* models with high protection degree (IP67); these are resistant to for example oil and coolants, and even last temporary immersion.

- Measuring range: 0- 1000 mm.
- Resolution: 0.01 mm.
- ABS/INC switchable (except 571.251 - 253).
- Digimatic data output.
- Reset.
- Max. measuring speed: any.
- Beam: 16 x 3.5 mm.
- Protection: IP67 (only *Coolant Proof* models).
- Conforms to factory standard.
- Delivery in a case.
- Power supply: 1 battery type V357.
- Also other models available (e.g. with hook or with tip).

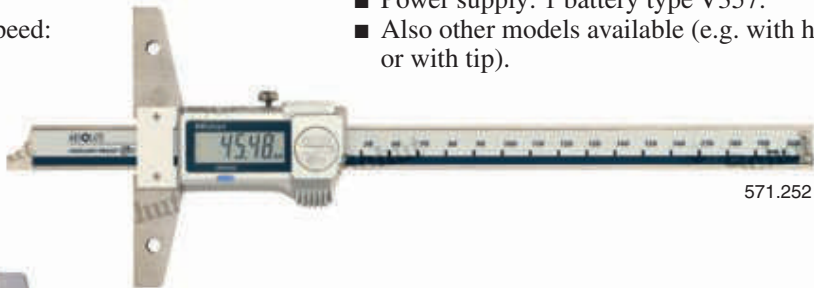

571.252

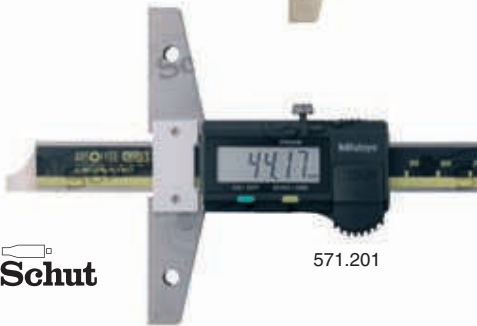

571.201

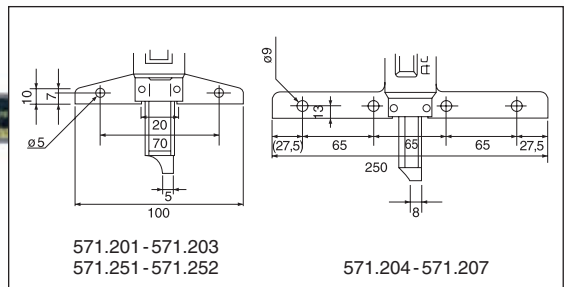

571.201 - 571.203
571.251 - 571.252

571.204 - 571.207

Data cables Digimatic, USB Input Tool Direct, U-WAVE available on request.

Item No.	Measuring range/mm	Base length/mm	Accuracy/mm	Price EUR
571.201	0- 150	100	±0.02	330.00
571.202	0- 200	100	±0.02	394.00
571.203	0- 300	100	±0.03	428.00
571.204	0- 450	250	±0.05	750.00
571.205	0- 600	250	±0.05	868.00
571.206	0- 750	250	±0.06	942.00
571.207	0- 1000	250	±0.07	1,039.00
Protection IP67 (Coolant Proof):				
571.251	0- 150	100	±0.02	377.00
571.252	0- 200	100	±0.02	438.00
571.253	0- 300	100	±0.03	488.00
Options:				
836.535	Spare battery			1.90
900.370	Removable bridge, length 180 mm (for depth calipers up to 300 mm)			54.00
900.371	Removable bridge, length 260 mm (for depth calipers up to 300 mm)			75.00
900.372	Removable bridge, length 320 mm (for depth calipers up to 300 mm)			85.00

Digital depth gauge

- Measuring range: 0-21.5 mm.
- Resolution: 0.01 mm.
- mm/inch conversion.
- On/off switch.
- Reset.
- Measuring face: 45 x 6 mm.
- Measuring pin: 6 x 2 mm, taper to 4 x 2 mm.
- Power supply: 1 battery type V357.



Item No.	Measuring range/mm	Price EUR
907.861	0-21.5	30.90
Option:		
836.535	Spare battery	1.90

Depth gauge with dial

- Measuring range: 0-25 mm.
- Graduation: 0.1 mm.
- Measuring face: 60 x 25 mm.
- Measuring pin: $\varnothing 3$ mm.



Item No.	Measuring range/mm	Price EUR
853.110	0-25	73.00

Depth calipers for keyway depths

- Measuring range: keyway depths 0-60 mm.
- Application range: cylinders $\varnothing 5$ -200 mm.
- Vernier: 0.05 mm.
- Stainless steel construction.

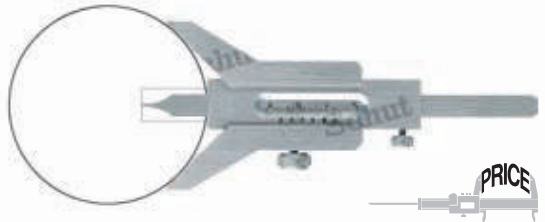

Item No.	Application range/mm	Price EUR
907.192	$\varnothing 5$ - 80	88.00
907.193	$\varnothing 6$ -120	115.00
907.194	$\varnothing 7$ -160	164.00
907.195	$\varnothing 8$ -200	134.00

Käfer depth dial indicators

- Measuring range: 0-30 mm.
- Graduation: 0.01 mm.
- Measuring pin shaft: $\varnothing 2$ mm.
- Measuring depth with pin 852.385: 200 mm.
- Excl. measuring pin and measuring base.
- Accuracy according DIN 878 (852.383) or factory standard (852.384).



Item No.	Measuring range/mm	Price EUR
852.383	0-10	124.00
852.384	0-30	218.00
Options:		
852.385	Measuring pin $\varnothing 2$ mm	8.50
907.153	Meas. base 63 x 17 mm	16.40
907.165	Meas. base 101.5 x 17 mm*	17.20

* Larger sizes available on request.

Digital depth micrometers IP65

Digital depth micrometers with interchangeable, spherical rods or flat rods. With the flat rods mainly flat and spherical surfaces can be measured very accurately. The spherical rods are especially suitable for beveled and hollow surfaces. The high accuracy of the rods makes resetting after exchanging the rods unnecessary. Two models with different base lengths available.

- Measuring range: 0-300 mm.
- Resolution: 0.001 mm.
- mm/inch conversion.
- ABS/INC switchable.
- Automatic switch-off.
- Preset.
- Measuring rods: $\varnothing 4.5$ mm.
- Locking screw.
- Protection: IP65.
- DIN 863 T2.
- Power supply: 1 battery type V357.



909.765



Model with spherical rods especially for hollow and beveled surfaces

Item No.	Price EUR	Item No.	Price EUR	Measuring range/mm	Accuracy mm	Number of rods
Base 63 mm:		Base 101.5 mm:				
909.753	150.00	909.759	150.00	0- 25	± 0.005	1
909.754	157.00	909.760	157.00	0- 50	± 0.005	2
909.755	171.00	909.761	171.00	0-100	± 0.006	4
909.756	185.00	909.762	185.00	0-150	± 0.007	6
909.757	199.00	909.763	199.00	0-200	± 0.008	8
909.758	234.00	909.764	234.00	0-300	± 0.009	12

Model with flat rods especially for flat and spherical surfaces

Item No.	Price EUR	Item No.	Price EUR	Measuring range/mm	Accuracy mm	Number of rods
Base 63 mm:		Base 101.5 mm:				
909.765	150.00	909.771	150.00	0- 25	± 0.005	1
909.766	157.00	909.772	157.00	0- 50	± 0.005	2
909.767	171.00	909.773	171.00	0-100	± 0.006	4
909.768	185.00	909.774	185.00	0-150	± 0.007	6
909.769	199.00	909.775	199.00	0-200	± 0.008	8
909.770	234.00	909.776	234.00	0-300	± 0.009	12

Option

Item No.	Description	Price EUR
836.535	Spare battery	1.90



Depth micrometers

Depth micrometers with interchangeable, spherical or flat rods. With the flat rods mainly flat and spherical surfaces can be measured very accurately. The spherical rods are especially suitable for beveled and hollow surfaces. The high accuracy of the rods makes recalibration after exchanging the rods unnecessary. Two models with different base lengths available.

- Measuring range: 0-300 mm.
- Graduation: 0.01 mm.
- Measuring rods: $\varnothing 4.5$ mm.
- Locking screw.
- DIN 863 T2.

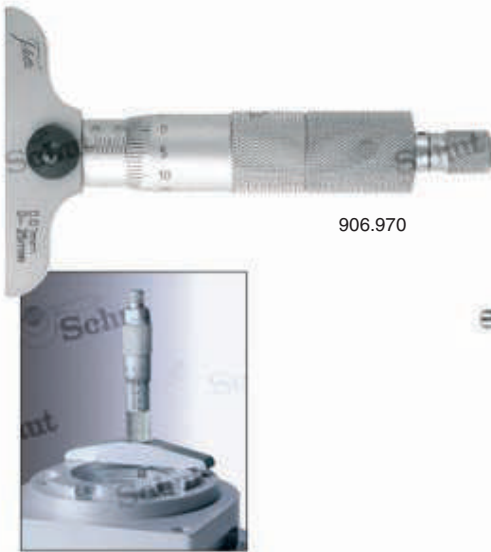

906.970

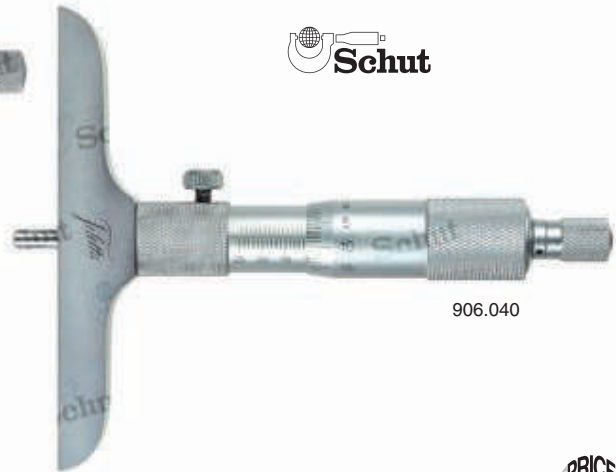

906.040

Model with spherical rods especially for hollow and beveled surfaces

Item No.	Price EUR	Item No.	Price EUR	Measuring range/mm	Accuracy mm	Number of rods
Base 63 mm:		Base 101.5 mm:				
906.964	37.30	906.040	37.30	0- 25	± 0.005	1
906.965	44.00	906.039	44.00	0- 50	± 0.005	2
906.966	56.00	906.041	56.00	0-100	± 0.006	4
906.967	72.00	906.042	72.00	0-150	± 0.007	6
906.968	105.00	906.043	105.00	0-200	± 0.008	8
906.969	145.00	906.044	145.00	0-300	± 0.009	12

Model with flat rods especially for flat and spherical surfaces

Item No.	Price EUR	Item No.	Price EUR	Measuring range/mm	Accuracy mm	Number of rods
Base 63 mm:		Base 101.5 mm:				
906.970	53.00	906.976	53.00	0- 25	± 0.005	1
906.971	63.00	906.977	63.00	0- 50	± 0.005	2
906.972	87.00	906.978	87.00	0-100	± 0.006	4
906.973	104.00	906.979	104.00	0-150	± 0.007	6
906.974	130.00	906.980	130.00	0-200	± 0.008	8
906.975	170.00	906.981	170.00	0-300	± 0.009	12

Mitutoyo depth micrometers

- Measuring range: 0-300 mm.
- Analog: graduation 0.01 mm, digital: resolution 0.001 mm.
- Accuracy micrometer: ± 0.003 mm.
- Increment of measuring rods: 25 mm.
- Hardened steel measuring rods: $\varnothing 4$ mm.
- DIN 863 T2 (analog) or factory standard (digital).
- Delivery in a case with adjustment tool.

Digital (Mitutoyo Digimatic)

- Length tolerance measuring rods: $\pm (2 + L/75) \mu\text{m}$ (L in mm).
- ABS/INC switchable.
- Digimatic data output.
- Reset/preset.

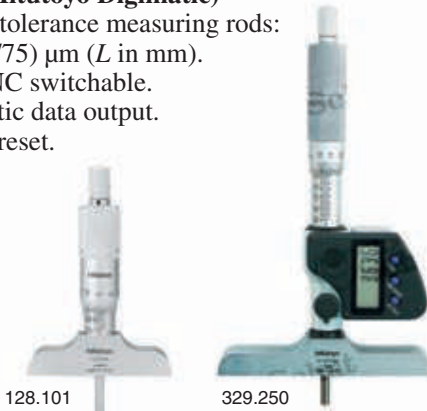

- Hold function.
- Power supply: 1 battery type V357.

Item No.	Measuring range/mm	Base l x w/mm	Number of rods	Price EUR
Mitutoyo analog depth micrometers:				
128.101	0- 25	63.5 x 16	1	139.00
128.102	0- 25	101.6 x 16	1	173.00
129.109	0- 50	63.5 x 16	2	162.00
129.113	0- 50	101.6 x 16	2	191.00
129.110	0- 75	63.5 x 16	3	164.00
129.114	0- 75	101.6 x 16	3	203.00
129.111	0-100	63.5 x 16	4	215.00
129.115	0-100	101.6 x 16	4	237.00
129.112	0-150	63.5 x 16	6	298.00
129.116	0-150	101.6 x 16	6	310.00
129.152	0-300	63.5 x 16	12	452.00
129.153	0-300	101.6 x 16	12	474.00
Mitutoyo Digimatic digital depth micrometers:				
329.250	0-150	101.6 x 16	6	750.00
329.251	0-300	101.6 x 16	12	975.00
Option:				
836.535	Spare battery			1.90

Data cables Digimatic, USB Input Tool Direct, U-WAVE available on request.

TESA depth micrometers

- Measuring range: 0-180 mm.
- Analog: graduation 0.01 mm, digital: resolution 0.001 mm.
- Max. deviation after exchanging measuring rods: 0.003 mm.
- Hardened steel measuring rods: $\varnothing 3$ mm.
- DIN 863 T2.
- Delivery in a case with two adjustment tools, an inspection report and a declaration of conformity.

Item No.	Measuring range/mm	Base l x w/mm	Number of rods	Price EUR
TESA Isomaster analog depth micrometers:				
779.102	0- 75	50 x 15	3	527.00
779.104	0- 75	100 x 15	3	592.00
779.103	0-150	50 x 15	6	642.00
779.105	0-150	100 x 15	6	688.00
TESA Micromaster digital depth micrometers:				
782.148	0- 90	50 x 15	3	1,062.00
782.149	0-180	100 x 15	6	1,230.00
Options:				
495.157	Spare battery			0.50
781.887	Opto-RS232C cable 9p (2 m)			120.00

Analog (TESA Isomaster)

- Increment of measuring rods: 25 mm.

Digital (TESA Micromaster)

- mm/inch conversion.
- Opto-RS232C data output, bidirectional.
- Automatic switch-off.
- Reset/preset.
- Increment of measuring rods: 30 mm.
- Power supply: 1 battery type CR2032.



Micrometers / Micrometer heads

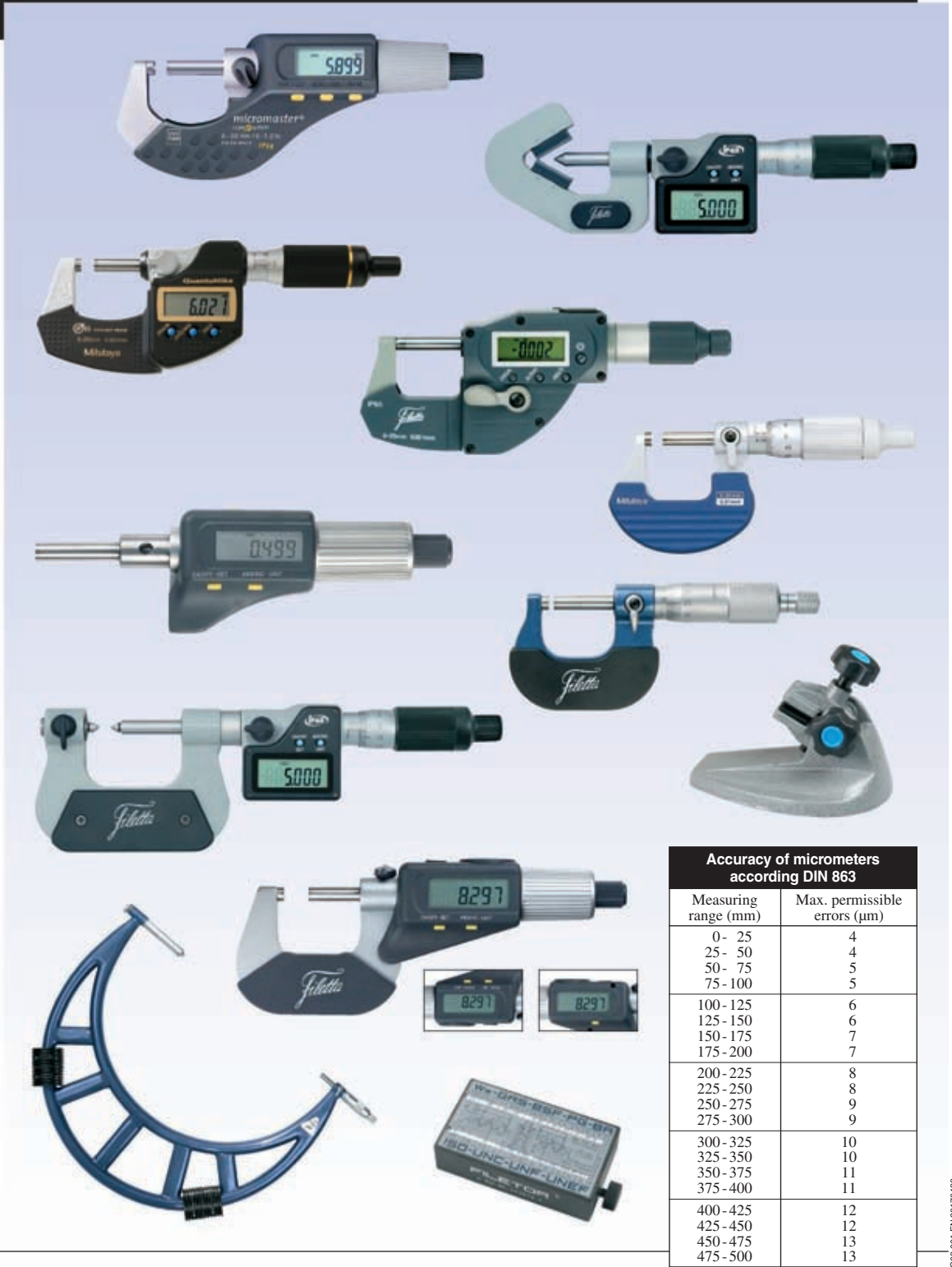

Accuracy of micrometers according DIN 863	
Measuring range (mm)	Max. permissible errors (µm)
0 - 25	4
25 - 50	4
50 - 75	5
75 - 100	5
100 - 125	6
125 - 150	6
150 - 175	7
175 - 200	7
200 - 225	8
225 - 250	8
250 - 275	9
275 - 300	9
300 - 325	10
325 - 350	10
350 - 375	11
375 - 400	11
400 - 425	12
425 - 450	12
450 - 475	13
475 - 500	13

Digital micrometers

Rugged digital micrometers with simple functions and an excellent price-performance ratio.

- Measuring range: 0-200 mm.
- Resolution: 0.001 mm.
- Automatic switch-off.
- Reset/preset.
- Tungsten carbide measuring faces: $\varnothing 6.5$ mm.
- DIN 863 T1.
- From measuring range 25 - 50 mm including setting gauge.
- Power supply: 1 battery type V357.



Item No.	Measuring range/mm	Accuracy mm	Price EUR
Not switchable:			
908.750	0- 25	± 0.004	55.00
908.751	25- 50	± 0.004	66.00
908.752	50- 75	± 0.005	73.00
908.753	75-100	± 0.005	80.00
908.754	100-125	± 0.006	88.00
908.755	125-150	± 0.006	97.00
908.756	150-175	± 0.007	107.00
908.757	175-200	± 0.007	117.00
Switchable mm/inch and ABS/INC:			
908.758	0- 25	± 0.004	60.00
908.759	25- 50	± 0.004	72.00
908.760	50- 75	± 0.005	78.00
908.761	75-100	± 0.005	86.00
908.762	100-125	± 0.006	94.00
908.763	125-150	± 0.006	103.00
908.764	150-175	± 0.007	113.00
908.765	175-200	± 0.007	124.00

Sets

Item No.	Measuring range/mm	Pieces	Price EUR
Not switchable:			
908.766	0- 75	3	194.00
908.767	0-100	4	274.00
908.768	0-150	6	459.00
Switchable mm/inch and ABS/INC:			
908.769	0- 75	3	210.00
908.770	0-100	4	296.00
908.771	0-150	6	509.00

Option

Item No.	Description	Price EUR
836.535	Spare battery	1.90

Digital micrometers

Rugged digital micrometers with simple functions and an excellent price-performance ratio.

- Measuring range: 0- 150 mm.
- Resolution: 0.001 mm.
- mm/inch conversion.
- ABS/INC switchable.
- Automatic switch-off.
- Reset/preset.
- Tungsten carbide measuring faces: $\varnothing 6.5$ mm.
- From measuring range 25- 50 mm including setting gauge.

- Delivery in a case with ball attachment and an inspection report.
- Power supply: 1 battery type CR2032.



Item No.	Measuring range/mm	Accuracy mm	Price EUR
909.982	0- 25	± 0.003	48.00
909.983	25- 50	± 0.003	61.00
909.984	50- 75	± 0.004	70.00
909.985	75- 100	± 0.004	81.00
909.986	100- 125	± 0.005	103.00
909.987	125- 150	± 0.005	121.00

Option:	495.157 Spare battery	0.50
----------------	-----------------------	------

Digital micrometers with double display

This patented micrometer distinguishes itself by its the two large displays on both sides of the instrument, which can also display upside-down. Therefore the measuring value can always be presented upright, which enables ergonomic read-out at all times. Add to this its measuring range of 30 mm, the tungsten carbide measuring faces and then check out its price.

- Measuring range: 0- 205 mm.
- Resolution: 0.001 mm.
- mm/inch conversion.
- ABS/INC switchable.
- Double LCD display.
- Second display can be switched on/off separately.



- Automatic switch-off.
- Reset/preset.
- Tungsten carbide measuring faces: $\varnothing 6.5$ mm.
- DIN 863 T1.
- From measuring range 25- 55 mm including setting gauge.
- Delivery in a case.
- Power supply: 1 battery type CR2032.



Item No.	Measuring range/mm	Accuracy mm	Price EUR
907.682	0- 30	± 0.004	142.00
907.683	25- 55	± 0.004	175.00
907.684	50- 80	± 0.005	187.00
907.685	75- 105	± 0.005	220.00
907.686	100- 130	± 0.006	252.00
907.687	125- 155	± 0.006	278.00
907.688	150- 180	± 0.007	303.00
907.689	175- 205	± 0.007	329.00

Option:	495.157 Spare battery	0.50
----------------	-----------------------	------

Digital micrometers with tolerance indication

These absolute digital micrometers are provided with both a tolerance and a hold function. They also have a large display.

- Measuring range: 0- 100 mm.
- Resolution: 0.001 mm.
- mm/inch conversion.
- ABS/INC switchable.
- Digit height: 9 mm.
- Automatic switch-off.
- Reset/preset.
- Hold function.
- Adjustable tolerance limits.
- Tungsten carbide measuring faces: $\varnothing 6.5$ mm.
- DIN 863 T1.
- Power supply: 1 battery type V357.



907.570



Item No.	Measuring range/mm	Accuracy mm	Price EUR
907.570	0- 25	± 0.004	76.00
907.571	25- 50	± 0.004	82.00
907.572	50- 75	± 0.005	95.00
907.573	75- 100	± 0.005	108.00
Option:			
836.535	Spare battery		1.90

Micrometers with counter

These solid micrometers have a counter with a resolution of 0.01 mm for an error free read-out of the measuring value, and a very favourable price-performance ratio.

- Measuring range: 0- 200 mm.
- Resolution: 0.01 mm.
- Numerical counter adjustable.
- Tungsten carbide measuring faces: $\varnothing 6.5$ mm.
- Delivery with adjustment tool.
- From measuring range 25 - 50 mm including setting gauge.



906.556



Sets (delivered incl. setting gauges)

Item No.	Measuring range/mm	Pieces	Price EUR
906.564	0- 75	3	138.00
906.565	0- 100	4	194.00
906.566	0- 150	6	337.00

Item No.	Measuring range/mm	Accuracy mm	Price EUR
906.556	0- 25	± 0.01	41.00
906.557	25- 50	± 0.01	46.00
906.558	50- 75	± 0.01	51.00
906.559	75- 100	± 0.01	56.00
906.560	100- 125	± 0.02	67.00
906.561	125- 150	± 0.02	77.00
906.562	150- 175	± 0.02	92.00
906.563	175- 200	± 0.02	103.00

Mitutoyo Digimatic micrometer

Digital micrometer with a very compact design.

- Measuring range: 0-25 mm.
- Resolution: 0.001 mm.
- Reset.
- Measuring force: 5-10 N.
- Spindle: $\varnothing 6.35$ mm.
- Ground and lapped tungsten carbide measuring faces.
- Varnished frame.
- Weight: 275 g.
- DIN 863 T1.
- Delivery in a case with an inspection report and a declaration of conformity.
- Power supply: 1 battery type V357.



Item No.	Measuring range/mm	Accuracy mm	Price EUR
293.821	0-25	± 0.002	148.00
Option:			
836.535	Spare battery		1.90

Mitutoyo Absolute Digimatic Quick Micrometer

Very fast adjustable digital micrometer (10 mm/rotation!) with the absolute system and a non-rotating spindle. It works according to the Abbe principle and has an almost unlimited measuring speed. All this makes the Quick Micrometer the most accurate 'quick meter' of its kind.

The model with adjustable measuring force is for measurements of small, vulnerable and deformable objects. Should be used in horizontal position for optimal accuracy of the measuring force.

- Measuring range: 0-30 mm.
- Resolution: 0.001 mm.
- On/off switch.
- Reset/preset.
- Hold function.
- Max. measuring speed: any.
- 1 revolution of the thimble = 10 mm.
- Flatness measuring faces: ≤ 0.3 μm .
- Parallelism measuring faces: ≤ 2.0 μm .
- Non-rotating spindle.
- Ground and lapped tungsten carbide measuring faces: $\varnothing 6.35$ mm.
- Varnished frame.
- Protection: IP54 (only 293.661/666). (When using data output: IP40.)
- Conforms to factory standard.
- Delivery in a case.
- Power supply: 1 battery type V357.
- Also larger sizes available.



293.666

Item No.	Measuring range/mm	Accuracy mm	Measuring force/N	Digimatic output	Price EUR
293.661	0-30	± 0.002	5 -10	no	357.00
293.666	0-30	± 0.002	5 -10	yes	384.00
With adjustable measuring force:					
227.205	0-10	± 0.002	2 -10	yes	1,002.00
227.202	0-15	± 0.002	2 -10	yes	922.00
227.201	0-15	± 0.002	0.5- 2.5	yes	1,039.00
Option:					
836.535	Spare battery				1.90

Data cables Digimatic, USB Input Tool Direct, U-WAVE available on request.



Setting measuring force (227.201/202/205)

Digital micrometers IP54

- Measuring range: 0 - 150 mm.
- Resolution: 0.001 mm.
- mm/inch conversion.
- Automatic switch-off.
- Reset.

- Tungsten carbide measuring faces: $\varnothing 6.5$ mm.
- Protection: IP54.
- DIN 863 T1.
- From measuring range 25 - 50 mm including setting gauge.
- Power supply: 1 battery type V357.



910.041

NEW**PRICE**

Sets

Item No.	Measuring range/mm	Pieces	Price EUR
910.053	0 - 75	3	235.00
910.054	0 - 100	4	334.00
910.055	0 - 150	6	576.00

Item No.	Measuring range/mm	Accuracy mm	Price EUR
910.041	0 - 25	± 0.004	66.00
910.042	25 - 50	± 0.004	79.00
910.043	50 - 75	± 0.005	89.00
910.044	75 - 100	± 0.005	99.00
910.045	100 - 125	± 0.006	116.00
910.046	125 - 150	± 0.006	126.00

Option:

836.535	Spare battery	1.90
---------	---------------	------

Digital micrometers IP65

These IP65 protected micrometers are especially suitable for use in production environments.

- Measuring range: 0 - 100 mm.
- Resolution: 0.001 mm.
- mm/inch conversion.
- ABS/INC switchable.
- On/off switch.
- Automatic switch-off.
- Reset.

- Tungsten carbide measuring faces: $\varnothing 6.5$ mm.
- Protection: IP65.
- From measuring range 25 - 50 mm including setting gauge.
- Delivery in a case with ball attachment and an inspection report.
- Power supply: 1 battery type CR2032.



909.988

PRICE

Item No.	Measuring range/mm	Accuracy mm	Price EUR
909.988	0 - 25	± 0.003	81.00
909.989	25 - 50	± 0.003	98.00
909.990	50 - 75	± 0.004	111.00
909.991	75 - 100	± 0.004	127.00

Option:

495.157	Spare battery	0.50
---------	---------------	------

Digital fast adjustable external measuring instruments

These digital external measuring instruments have an IP65 classification and are therefore not only resistant to dust, but can also withstand water jets. The non-rotating spindle is lever operated and fast adjustable.

- Measuring range: 0- 100 mm.
- Resolution: 0.001 mm.
- mm/inch conversion.
- ABS/INC switchable.
- Digimatic data output.
- On/off switch.
- Reset.
- Non-rotating spindle.
- Tungsten carbide measuring faces: $\varnothing 6.5$ mm.
- Protection: IP65.
- From measuring range 25 - 50 mm including setting gauge.
- Delivery in a case with ball attachment and an inspection report.
- Power supply: 1 battery type CR2032.



909.994

NEW



909.686



910.039/038



909.687



Item No.	Measuring range/mm	Accuracy mm	Price EUR
909.994	0- 25	± 0.003	157.00
909.995	25- 50	± 0.003	179.00
909.996	50- 75	± 0.004	201.00
909.997	75- 100	± 0.004	223.00
With Bluetooth:			
910.075	0- 25	± 0.003	158.00
Options:			
495.157	Spare battery		0.50
909.686	USB interface		101.00
909.687	Footswitch		17.30
910.038	Wireless USB receiver		47.00
910.039	Wireless sender		47.00

Digital micrometers IP65

These digital micrometers have an IP65 classification and are therefore not only resistant to dust but can also withstand water jets. Also available as fast adjustable micrometers with a pitch of 2 mm.

- Measuring range: 0- 300 mm.
 - Resolution: 0.001 mm.
 - mm/inch conversion.
 - ABS/INC switchable.
 - On/off switch.
 - Automatic switch-off.
 - Tungsten carbide measuring faces: $\varnothing 6.5$ mm.
 - Protection: IP65.
 - DIN 863 T1.
 - From measuring range 25 - 50 mm including setting gauge.
 - Power supply: 1 battery type V357.
- Fast adjustable micrometers**
- 1 revolution of the thimble = 2 mm.



909.549



909.545

Item No.	Measuring range/mm	Accuracy mm	Price EUR
909.549	0 - 25	± 0.002	75.00
909.550	25 - 50	± 0.002	90.00
909.551	50 - 75	± 0.003	107.00
909.552	75 - 100	± 0.003	124.00
909.556	100 - 125	± 0.003	145.00
909.557	125 - 150	± 0.003	163.00
909.558	150 - 175	± 0.004	180.00
909.559	175 - 200	± 0.004	198.00
909.560	200 - 225	± 0.004	217.00
909.561	225 - 250	± 0.004	233.00
909.562	250 - 275	± 0.005	250.00
909.563	275 - 300	± 0.005	268.00
Option:			
836.535	Spare battery		1.90

Fast adjustable micrometers

Item No.	Measuring range/mm	Accuracy mm	Price EUR
909.545	0 - 25	± 0.002	140.00
909.546	25 - 50	± 0.002	157.00
909.547	50 - 75	± 0.003	175.00
909.548	75 - 100	± 0.003	192.00

Sets

Item No.	Measuring range/mm	Pieces	Price EUR
909.577	0 - 75	3	278.00
909.578	0 - 100	4	406.00
909.579	0 - 150	6	714.00

TESA Micromaster digital *capa μ* micrometers IP54

This line of digital micrometers with the patented *capa μ* measuring system has a very light-weight and ergonomic design and is equipped with a large easy-to-read LCD display with 7 mm large digits. Especially the high protection degree – IP54 against dust and splash water – makes this series of micrometers very suitable for use in workshop conditions. The friction thimble ensures a constant measuring force of approximately 10 N for optimal repeatability.

- Measuring range: 0-300 mm.
- Resolution: 0.001 mm.
- mm/inch conversion.
- ABS/INC switchable.
- With or without bidirectional Opto-RS232C data output.
- Automatic switch-off.
- Reset/preset and hold function.
- Locking screw.
- Friction thimble.
- Tungsten carbide measuring faces: $\varnothing 6.5$ mm (from measuring range 100-125 mm: $\varnothing 8$ mm).
- No-glare chrome finished frame with insulating grip.
- Protection: IP54.
- (When using data output: IP40.)
- DIN 863 T1.
- Delivery in a case with an inspection report and a declaration of conformity.
- Power supply: 1 battery type CR2032.



782.102



782.105



782.100



Item No.	Measuring range/mm	Accuracy mm	Price EUR
Without Opto-RS232C data output:			
782.100 ¹	0- 30	±0.004	315.00
782.101	0- 30	±0.004	326.00
782.102	25- 50	±0.004	403.00
782.103	50- 75	±0.005	460.00
782.104	75-100	±0.005	521.00
With Opto-RS232C data output:			
782.105	0- 30	±0.004	351.00
782.106	25- 50	±0.004	445.00
782.107	50- 75	±0.005	528.00
782.108	75-100	±0.005	584.00
782.115	100-125	±0.006	754.00
782.116	125-150	±0.006	768.00
782.117	150-175	±0.007	778.00
782.118	175-200	±0.007	793.00
782.119	200-225	±0.008	840.00
782.122	225-250	±0.008	856.00
782.123	250-275	±0.009	882.00
782.124	275-300	±0.009	911.00
Option:			
495.157	Spare battery		0.50

¹ Micromaster “Easy”: simple model with protection IP40 and without preset function.

Mitutoyo Digimatic and *QuantuMike* micrometers IP65

These digital *Coolant Proof* micrometers have an IP65 classification and are therefore not only resistant to dust but can also withstand water jets. The large and clear LCD display with 7.5 mm high digits enables easy read-out. New in this line is the revolutionary *QuantuMike* with a pitch of 2 mm. The spindle feed is therefore 4x as fast. This way, the *QuantuMike* offers you a reduction in costs.

- Measuring range: 0-100 mm.
- Resolution: 0.001 mm.
- ABS/INC switchable.
- Automatic switch-off.
- Reset.
- ABS reset by means of origin.
- Hold function.
- 1 revolution of the thimble = 2 mm (only *QuantuMike*).
- Locking screw.
- Tungsten carbide measuring faces: $\varnothing 6.35$ mm.
- Varnished frame with insulating grip.
- Protection: IP65.
- Conforms to factory standard.
- Delivery in a case with an inspection report (0-50 mm) and a declaration of conformity.
- Power supply: 1 battery type V357.
- Battery life: approx. 2.4 years.
- The standard model with data output (293.230-293.233) is available up to 300 mm, and is also available in sets.



Item No.	Measuring range/mm	Accuracy mm	Digimatic output	Price EUR
293.240	0 - 25	± 0.001	no	194.00
293.241	25 - 50	± 0.001	no	272.00
293.242	50 - 75	± 0.001	no	329.00
293.243	75 - 100	± 0.002	no	374.00
293.230	0 - 25	± 0.001	yes	251.00
293.231	25 - 50	± 0.001	yes	295.00
293.232	50 - 75	± 0.001	yes	389.00
293.233	75 - 100	± 0.002	yes	429.00
293.234 ¹	0 - 25	± 0.001	yes	300.00
293.244 ¹	0 - 25	± 0.001	no	207.00

QuantuMike:

293.145	0 - 25	± 0.001	no	213.00
293.146	25 - 50	± 0.001	no	294.00
293.147	50 - 75	± 0.001	no	352.00
293.148	75 - 100	± 0.002	no	399.00
293.140	0 - 25	± 0.001	yes	302.00
293.141	25 - 50	± 0.001	yes	372.00
293.142	50 - 75	± 0.001	yes	451.00
293.143	75 - 100	± 0.002	yes	503.00

Options:

836.535	Spare battery	1.90
105.662 ²	Digimatic data cable, 1 m	77.00
105.663 ²	Digimatic data cable, 2 m	87.00
106.380 ²	USB Input Tool Direct cable, 2 m	119.00
102.791 ²	U-WAVE data cable	97.00

¹ With ratchet thimble.

² With data switch.

Mitutoyo Absolute Digimatic Submicrometer MDH

Micrometer with a higher resolution (switchable) and accuracy.

- Measuring range: 0-25 mm.
- Resolution: **0.0001** or 0,0005 mm.
- Digimatic data output.
- On/off switch.
- Automatic switch-off.
- Reset/preset.
- Hold function.
- Measuring force: 7-9 N.
- Spindle: \varnothing 6.35 mm.
- Locking screw.
- Tungsten carbide measuring faces: \varnothing 3.2 mm.
- Varnished frame with insulating grip.
- Absolute rotary sensor.
- Weight: 400 g.
- Conforms to factory standard.
- Delivery in a case with an inspection report.
- Power supply: 1 battery type CR2032.



Item No.	Measuring range/mm	Accuracy mm	Price EUR
293.100	0-25	\pm 0.0005	1,457.00
Options:			
495.157	Spare battery		0.50
105.662 ¹	Digimatic data cable, 1 m		77.00
105.663 ¹	Digimatic data cable, 2 m		87.00
106.380 ¹	USB Input Tool Direct cable, 2 m		119.00
102.791 ¹	U-WAVE data cable		97.00

¹ With data switch.

Mitutoyo Quick Mini digital quick thickness gauge

The measuring instrument to always carry with you. Pull back the switch, insert the sample, release the switch and read the value!

- Measuring range: 0-12 mm.
- Resolution: 0.01 mm.
- Accuracy: \pm 0.02 mm.
- Repeatability: 0.01 mm.
- ABS/INC switchable.
- Reset.
- Measuring force: 2 N.
- Anvil measuring face: \varnothing 6.5 mm.
- Pin measuring face: \varnothing 5 mm.
- Delivery in a case.
- Power supply: 1 battery type V357.



Item No.	Measuring range/mm	Price EUR
700.119	0-12	115.00
Option:		
836.535	Spare battery	1.90

Micrometers

- Measuring range: 0 - 300 mm.
- Graduation: 0.01 mm.
- Friction thimble.
- Tungsten carbide measuring faces: $\varnothing 6.5$ mm.
- DIN 863 T1.
- From measuring range 25 - 50 mm including setting gauge.



Item No.	Measuring range/mm	Accuracy mm	Price EUR
906.000	0 - 25	± 0.004	16.50
906.001	25 - 50	± 0.004	18.00
906.002	50 - 75	± 0.005	20.00
906.003	75 - 100	± 0.005	22.00
906.004	100 - 125	± 0.006	25.50
906.005	125 - 150	± 0.006	29.80
906.006	150 - 175	± 0.007	34.90
906.007	175 - 200	± 0.007	39.20
906.008	200 - 225	± 0.008	43.00
906.009	225 - 250	± 0.008	47.00
906.010	250 - 275	± 0.009	51.00
906.011	275 - 300	± 0.009	56.00

Model for left- and right-handed use:

907.167	0 - 25	± 0.004	21.90
907.168	25 - 50	± 0.004	24.30
907.169	50 - 75	± 0.005	26.30
907.170	75 - 100	± 0.005	29.00

Sets

Item No.	Measuring range/mm	Price EUR
906.055	0 - 75	63.00
906.056	0 - 100	76.00
906.057	0 - 150	132.00
906.058	150 - 300	272.00
906.059	0 - 300	404.00



Double graduation: for left- and right-handed use.

Micrometers 0.001 mm, parallax-free

Rugged micrometers with a vernier graduation of 0.001 mm and a favourable price-performance ratio.

- Measuring range: 0-200 mm.
- Vernier: 0.001 mm, parallax-free by enlarged thimble.
- Friction thimble.
- Tungsten carbide measuring faces: $\varnothing 6.5$ mm.
- DIN 863 T1.
- Delivery incl. adjustment tool.
- From measuring range 25-50 mm including setting gauge.



906.280

Item No.	Measuring range/mm	Accuracy mm	Price EUR
906.280	0- 25	± 0.004	51.00
906.281	25- 50	± 0.004	55.00
906.282	50- 75	± 0.005	59.00
906.283	75-100	± 0.005	63.00
906.284	100-125	± 0.006	69.00
906.285	125-150	± 0.006	77.00
906.286	150-175	± 0.007	81.00
906.287	175-200	± 0.007	89.00

Fast adjustable micrometers

Fast adjustable micrometers because one revolution results in a displacement of 1 mm. The measuring value can be read directly from the 100 step graduation on the thimble.

- Measuring range: 0-200 mm.
- Graduation: 0.01 mm.
- 1 revolution of the thimble = 1 mm.
- Thimble with 100 step graduation.
- Tungsten carbide measuring faces: $\varnothing 8$ mm.
- DIN 863 T1.
- From measuring range 25-50 mm including setting gauge.



907.000

Item No.	Measuring range/mm	Accuracy mm	Price EUR
907.000	0- 25	± 0.004	40.00
907.001	25- 50	± 0.004	44.00
907.002	50- 75	± 0.005	51.00
907.003	75-100	± 0.005	55.00
907.004	100-125	± 0.006	65.00
907.005	125-150	± 0.006	73.00
907.006	150-175	± 0.007	81.00
907.007	175-200	± 0.007	89.00



TESA Isomaster micrometers

- Measuring range: 0 - 300 mm.
- Graduation: 0.01 mm.
- Tungsten carbide measuring faces:
 - 0 - 100 mm: $\varnothing 6.5$ mm,
 - 100 - 300 mm: $\varnothing 8$ mm.
- No-glare chrome finished frame and thimble (0 - 100 mm), or varnished frame and chrome finished thimble (100 - 300 mm).
- DIN 863 T1.
- Delivery in a case with adjustment tool, an inspection report and a declaration of conformity.



779.005

Item No.	Measuring range/mm	Accuracy mm	Price EUR
779.005	0 - 25	± 0.004	172.00
779.006	25 - 50	± 0.004	253.00
779.007	50 - 75	± 0.005	268.00
779.008	75 - 100	± 0.005	308.00
779.009	100 - 125	± 0.006	460.00
779.010	125 - 150	± 0.006	482.00

Item No.	Measuring range/mm	Accuracy mm	Price EUR
779.011	150 - 175	± 0.007	500.00
779.012	175 - 200	± 0.007	537.00
779.013	200 - 225	± 0.008	583.00
779.014	225 - 250	± 0.008	630.00
779.015	250 - 275	± 0.009	651.00
779.016	275 - 300	± 0.009	700.00

Tesamaster micrometers

- Measuring range: 0 - 250 mm.
- Vernier: 0.001 mm, parallax-free.
- Counter resolution: 0.1 mm.
- Tungsten carbide measuring faces:
 - 0 - 100 mm: $\varnothing 6.5$ mm,
 - 100 - 250 mm: $\varnothing 8$ mm.
- No-glare chrome finished frame and thimble (0 - 100 mm), or varnished frame and chrome finished thimble (100 - 250 mm).
- DIN 863 T1.
- Delivery in a case with adjustment tool, an inspection report and a declaration of conformity.

- Also fast adjustable models available (with a pitch of 1 mm).



779.206

Item No.	Measuring range/mm	Accuracy mm	Price EUR
779.206	0 - 25	± 0.004	277.00
779.207	25 - 50	± 0.004	352.00
779.208	50 - 75	± 0.005	376.00
779.209	75 - 100	± 0.005	406.00
779.210	100 - 125	± 0.006	546.00
779.211	125 - 150	± 0.006	593.00

Item No.	Measuring range/mm	Accuracy mm	Price EUR
779.212	150 - 175	± 0.007	629.00
779.213	175 - 200	± 0.007	670.00
779.215	225 - 250	± 0.008	728.00

Mitutoyo lightweight micrometers

Mitutoyo micrometers in a lightweight workshop design.

- Measuring range: 0- 300 mm.
- Graduation: 0.01 mm.
- Measuring force: 5- 10 N (from 100 mm: 5- 15 N).
- Locking screw.
- Tungsten carbide measuring faces: $\varnothing 6.35$ mm.
- Varnished frame with insulating grip (from 75 mm).
- Delivery in a case incl. adjustment tool and setting gauge (except 103.137).
- Delivery with an inspection report (only 103.137/138).
- Available up to 1000 mm.



103.137



NEW



Item No.	Measuring range/mm	Accuracy mm	Price EUR
103.137	0- 25	± 0.002	45.00
103.138	25- 50	± 0.002	65.00
103.139	50- 75	± 0.002	86.00
103.140	75- 100	± 0.003	93.00
103.141	100- 125	± 0.003	146.00
103.142	125- 150	± 0.003	162.00
103.143	150- 175	± 0.004	181.00
103.144	175- 200	± 0.004	198.00
103.145	200- 225	± 0.004	221.00
103.146	225- 250	± 0.005	245.00
103.147	250- 275	± 0.005	258.00
103.148	275- 300	± 0.005	276.00

Sets (delivered incl. setting gauges)

Item No.	Measuring range/mm	Pieces	Price EUR
103.927	0- 75	3	223.00
103.913	0- 150	6	476.00
103.915	150- 300	6	1,202.00
103.914	0- 300	12	1,863.00

Mitutoyo micrometers

- Measuring range: 0 - 100 mm.
- Graduation: 0.01 mm.
- Measuring force: 5 - 10 N.
- Locking screw.
- Tungsten carbide measuring faces: $\varnothing 6.35$ mm.
- No-glare chrome finished frame with insulating grip.
- Delivery in a case incl. setting gauge (except 102.301).
- Delivery with an inspection report (only 102.301/302).



Set (delivered incl. setting gauges)

Item No.	Measuring range/mm	Pieces	Price EUR
102.911	0-100	4	326.00

Item No.	Measuring range/mm	Accuracy mm	Price EUR
102.301	0 - 25	± 0.002	48.00
102.302	25 - 50	± 0.002	75.00
102.303	50 - 75	± 0.002	97.00
102.304	75 - 100	± 0.003	115.00

Mitutoyo micrometers with a constant measuring force

Mitutoyo micrometers with a constant measuring force due to a special combined thimble construction. The insulating grip is especially designed for maximum grip with one-handed operation.

- Measuring range: 0 - 50 mm.
- Graduation: 0.01 mm or vernier 0.001 mm.
- Measuring force: 5 - 10 N.
- Locking screw.
- Tungsten carbide measuring faces: $\varnothing 6.35$ mm.
- No-glare chrome finished frame with insulating grip.
- Delivery in a case incl. adjustment tool and setting gauge (except 102.701/707).
- Delivery with an inspection report.



Item No.	Measuring range/mm	Graduation mm	Accuracy mm	Price EUR
102.701	0-25	0.01	± 0.002	56.00
102.702	25-50	0.01	± 0.002	84.00
102.707	0-25	0.001	± 0.002	77.00
102.708	25-50	0.001	± 0.002	125.00

Micrometers with a large measuring range

The varnished tubular frame is very stable and equipped with heat insulating grips. With two spacers for a large measuring span.

- Measuring range: 300-2000 mm.
- Measuring span:
 - 300-1000 mm: 100 mm
(travel 25 mm, spacers 25 and 50 mm),
 - 1000-2000 mm: 200 mm
(travel 50 mm, spacers 50 and 100 mm).
- Graduation: 0.01 mm.
- Rotating spindle.
- Tungsten carbide measuring faces: $\varnothing 8$ mm.
- No-glare chrome finished thimble.
- DIN 863 T3.
- With two setting gauges.

Item No.	Measuring range/mm	Accuracy mm	Price EUR
Measuring span 100 mm:			
906.012	300- 400	± 0.011	186.00
906.013	400- 500	± 0.013	210.00
906.014	500- 600	± 0.015	247.00
906.015	600- 700	± 0.016	287.00
906.016	700- 800	± 0.018	349.00
906.017	800- 900	± 0.020	406.00
906.018	900-1000	± 0.020	455.00
Measuring span 200 mm:			
906.019	1000-1200	± 0.020	972.00
906.020	1200-1400	± 0.024	1,038.00
906.021	1400-1600	± 0.028	1,156.00
906.022	1600-1800	± 0.031	1,228.00
906.023	1800-2000	± 0.034	1,299.00

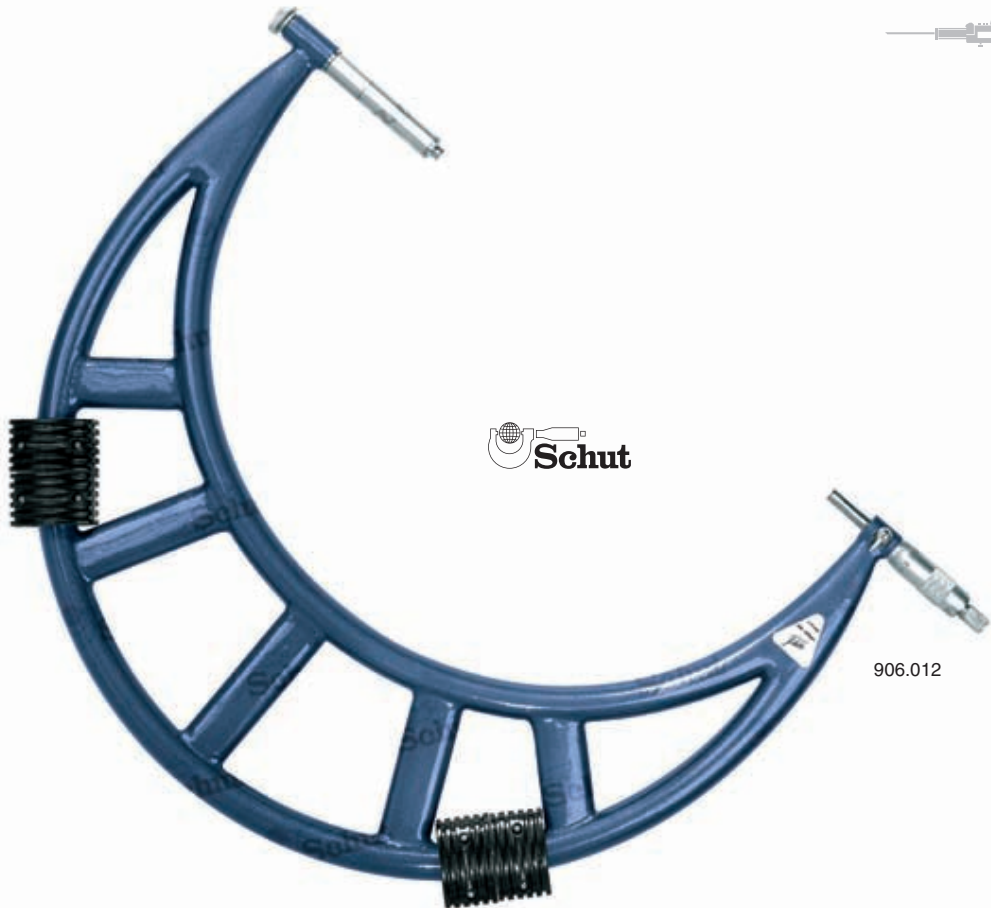

Delivery ex Groningen, Netherlands

Micrometers with a large measuring range

Micrometers with a large measuring range, with very accurate, interchangeable anvils.

- Measuring range: 0 - 300 mm.
- Graduation: 0.01 mm.
- Tungsten carbide measuring faces: $\varnothing 6.35$ mm.
- Delivery incl. setting gauges and interchangeable anvils (increasing per 25 mm).



906.290

PRICE

Item No.	Measuring range/mm	Accuracy mm	Number of anvils	Number of setting gauges	Price EUR
906.290	0 - 50	± 0.004	2	1	51.00
906.294	0 - 100	± 0.005	4	3	101.00
906.292	0 - 150	± 0.006	6	5	128.00
906.291	50 - 100	± 0.005	2	2	67.00
906.295	100 - 200	± 0.007	4	4	146.00
906.293	150 - 300	± 0.009	6	6	162.00
906.296	200 - 300	± 0.009	4	4	157.00

Micrometers with adjustable anvil with dial indicator

Micrometers with an adjustable anvil with dial indicator, for measurements in a wide measuring range.

- Measuring range: 0 - 1000 mm.
- Graduation: 0.01 mm.
- Tungsten carbide measuring faces: $\varnothing 8$ mm.

Specifications dial indicator:

- Graduation: 0.01 mm.
- Range adjustable anvil: 5 mm.
- Max. measuring force anvil with dial indicator: 10 N.
- Adjustable tolerance markers.



907.015

PRICE

Item No.	Measuring range/mm	Accuracy mm	Price EUR
907.015	0 - 100	± 0.006	178.00
907.016	100 - 200	± 0.007	220.00
907.017	200 - 300	± 0.008	232.00
907.018	300 - 400	± 0.009	329.00
907.019	400 - 500	± 0.010	382.00
907.020	500 - 600	± 0.011	414.00
907.021	600 - 700	± 0.012	490.00
907.022	700 - 800	± 0.013	578.00
907.023	800 - 900	± 0.014	637.00
907.024	900 - 1000	± 0.015	726.00

Digital micrometers IP65 with a large measuring range

- Measuring range: 0 - 1000 mm.
- Resolution: 0.001 mm.
- mm/inch conversion.
- ABS/INC switchable.
- Automatic switch-off.
- Reset/preset.
- Rotating spindle.
- Adjustable tolerance limits.
- Tungsten carbide measuring faces: $\varnothing 6.35$ mm.
- 0 - 300 mm: cast iron frame, 300 - 1000 mm: tubular steel frame with insulating grips.
- Protection: IP65.
- Delivery in a case with setting gauges and interchangeable anvils.
- Power supply: 1 battery type V357.



909.580



Item No.	Measuring range/mm	Accuracy mm	Number of anvils	Number of setting gauges	Price EUR
909.580	0 - 100	± 0.005	4	3	185.00
909.581	100 - 200	± 0.007	4	4	199.00
909.582	200 - 300	± 0.008	4	4	220.00
909.583	300 - 400	± 0.009	4	2	259.00
909.584	400 - 500	± 0.010	4	2	283.00
909.585	500 - 600	± 0.010	4	2	318.00
909.586	600 - 700	± 0.011	4	2	364.00
909.587	700 - 800	± 0.012	4	2	413.00
909.588	800 - 900	± 0.013	4	2	469.00
909.589	900 - 1000	± 0.013	4	2	514.00
Option: 836.535 Spare battery					1.90

TESA micrometers with a large measuring range

Micrometers with interchangeable anvils and a measuring span of 100 mm. The anvils are adjusted and numbered in sets, so they can be changed without resetting the micrometer. Therefore only one setting gauge per micrometer is needed.

- Measuring range: 0-500 mm.
- Analog: graduation 0.01 mm, digital: resolution 0.001 mm.
- Max. measuring force: 10 N.
- Tungsten carbide measuring faces: $\varnothing 8$ mm.
- 0-500 mm: cast iron frame, ≥ 500 mm: tubular steel frame with insulating grips.
- DIN 863 T3.
- Delivery in a case with 4 anvils (779.069), an inspection report and a declaration of conformity.
- Available on request up to 1500 mm.

Digital

- mm/inch conversion.
- ABS/INC switchable.
- Opto-RS232C data output.
- Power supply: 1 battery type CR2032.

Adjustable dial indicator element

Can replace the interchangeable anvils. Facilitates finding the reversal point. The spring in the element ensures a constant measuring force.

- Measuring range: ± 1.5 mm.
- Graduation: 0.01 mm.
- Clamping stem: $\varnothing 11$ mm.

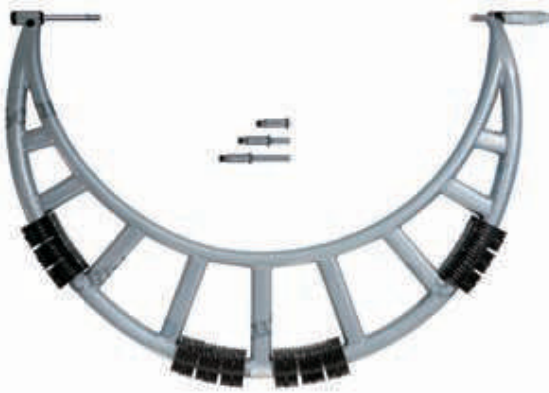

Delivery ex Groningen, Netherlands



Analog (Isomaster)

Item No.	Measuring range/mm	Accuracy mm	Price EUR
779.021	0-100	± 0.006	952.00
779.022	100-200	± 0.007	1,100.00
779.023	200-300	± 0.008	1,281.00
779.024	300-400	± 0.009	1,440.00
779.025	400-500	± 0.010	1,624.00



779.070

Digital (Micromaster)

Item No.	Measuring range/mm	Accuracy mm	Price EUR
782.610	0-100	± 0.006	1,133.00
782.611	100-200	± 0.007	1,238.00
782.612	200-300	± 0.008	1,356.00
782.613	300-400	± 0.009	1,495.00
782.614	400-500	± 0.010	1,609.00

Options:

495.157	Spare battery	0.50
781.887	Opto-RS232C cable 9p (2m)	120.00
779.069	Set of 4 interchangeable anvils	595.00
779.070	Dial indicator element	887.00

Micrometers with dial indicator

Micrometers with adjustable anvil and clamping shaft for a dial indicator. Especially suitable for Go/NoGo judgement and batch measurements.

- Measuring range: 0- 175 mm.
- Graduation thimble and dial indicator: 0.01 mm.
- Range adjustable anvil: 8 mm.
- Trigger for (fast) adjustment.
- Tungsten carbide measuring faces: $\varnothing 6.5$ mm.
- Can also be used in combination with various other dial indicators with clamping stem $\varnothing 8$ mm.



Item No.	Measuring range/mm	Accuracy mm	Price EUR
907.008	0- 25	± 0.004	126.00
907.009	25- 50	± 0.004	134.00
907.010	50- 75	± 0.005	143.00
907.011	75-100	± 0.005	151.00
907.012	100-125	± 0.006	159.00
907.013	125-150	± 0.006	163.00
907.014	150-175	± 0.007	171.00

Mini-micrometer

- Measuring range: 0- 15 mm.
- Graduation: 0.01 mm.
- Measuring faces: $\varnothing 5$ mm.
- Without friction thimble.
- Dimensions:
total length: 70 mm,
throat depth: 14 mm.



Item No.	Measuring range/mm	Price EUR
906.180	0- 15	21.30

Micrometer with an extra large measuring range

The measuring range of this micrometer can be 'switched' from 25- 50 to 0-25 mm by easy mounting of the prolonged anvil.

- Measuring range: 0- 50 mm.
- Graduation: 0.01 mm.
- Accuracy: ± 0.004 mm.
- Tungsten carbide measuring faces: $\varnothing 6.5$ mm.
- Delivery incl. adjustment tool and prolonged anvil.



Item No.	Measuring range/mm	Accuracy mm	Price EUR
906.567	0- 50	± 0.004	62.00

Tolerance micrometers with precision dial indicator

Because of the retractable anvil, the fine adjustment and the tolerance markers very suitable for batch inspection and tolerance measurements.

- Measuring range: 0 - 100 mm.
- Measuring range dial indicator: ± 0.04 mm.
- Graduation (dial indicator): 0.001 mm.
- Accuracy:
 - micrometer: ± 0.003 mm (only 906.568),
 - dial indicator: ± 0.001 mm.
- Measuring force: 5 - 10 N (only 906.569/570/571/614).
- Adjustable tolerance markers.
- Tungsten carbide measuring faces:
 - 906.568 - 599: $\varnothing 6.5$ mm,
 - 906.569 - 614: $\varnothing 10$ mm.



Item No.	Measuring range/mm	Graduation mm	Vernier thimble/mm	Price EUR
906.568	0 - 25	0.001	0.002	190.00
906.597	25 - 50	0.001	–	218.00
906.598	50 - 75	0.001	–	247.00
906.599	75 - 100	0.001	–	287.00
With protection IP54:				
906.569	0 - 25	0.001	–	255.00
906.570	25 - 50	0.001	–	281.00
906.571	50 - 75	0.001	–	300.00
906.614	75 - 100	0.001	–	323.00

Tolerance micrometers with two spindles

Can be used as a Go/NoGo micrometer by setting of the lower and upper limits.

- Measuring range: 0 - 50 mm.
- Vernier: 0.002 mm.
- Accuracy: ± 0.003 mm.
- Tungsten carbide measuring faces: $\varnothing 6.5$ mm.

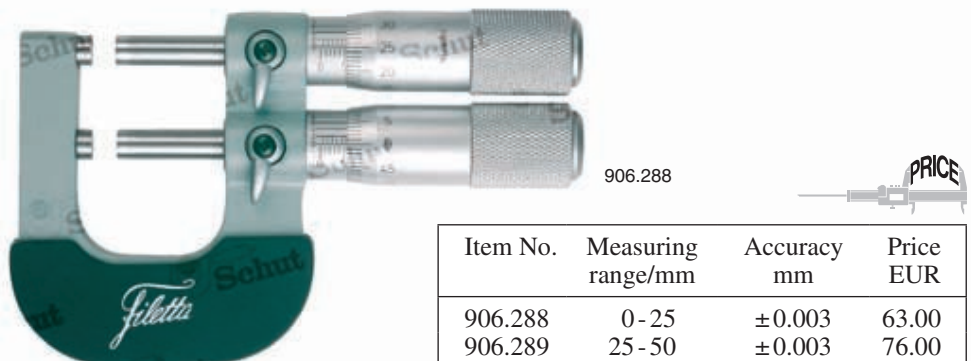

Item No.	Measuring range/mm	Accuracy mm	Price EUR
906.288	0 - 25	± 0.003	63.00
906.289	25 - 50	± 0.003	76.00

Snap gauges with dial indicator

Snap gauges with adjustable anvil and clamping shaft for a dial indicator. Especially suitable for Go/NoGo judgement and batch measurements.

- Measuring range: 0- 300 mm.
- Measuring force: 6-9 N.
- Clamping shaft: $\varnothing 8$ mm (dial gauge not included).
- Travel of moving anvil: 3 mm.
- Anvil size: 14 x 11 mm.

- Chamfered anvils for easy insertion.
- For suitable dial indicators refer to the dial indicators elsewhere in this catalog.

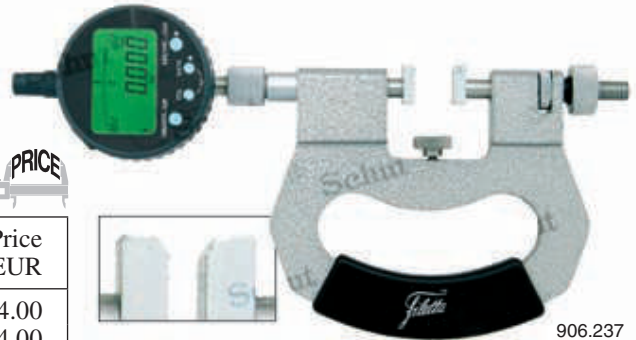

906.237

Item No.	Measuring range/mm	Length/mm		Price EUR
		A	B	
906.237	0- 25	42	20	164.00
906.238	25- 50	69	32.5	184.00
906.239	50- 75	94	45	206.00
906.240	75- 100	119	57.5	232.00
906.241	100- 125	144	70	252.00
906.242	125- 150	169	82.5	271.00
906.243	150- 175	194	95	290.00
906.244	175- 200	219	107.5	310.00
906.245	200- 225	244	120	329.00
906.246	225- 250	269	132.5	348.00
906.247	250- 275	294	145	368.00
906.248	275- 300	319	157.5	387.00

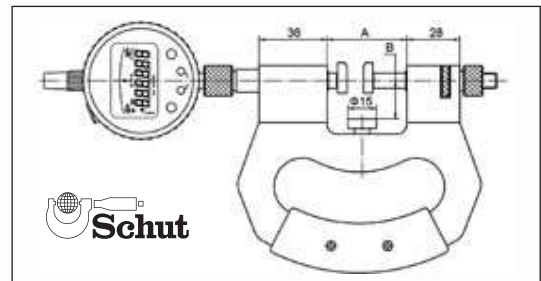

Digital vertical micrometers

Digital vertical micrometers for easy reading, for example, when measuring the thickness of metal or plastic sheet. These micrometers have an IP65 classification and are therefore not only resistant to dust but can also withstand water jets.

- Measuring range: 0- 50 mm.
- Resolution: 0.001 mm.
- Accuracy: ± 0.002 mm.
- mm/inch conversion.

- ABS/INC switchable.
- On/off switch.
- Automatic switch-off.
- Tungsten carbide measuring faces: $\varnothing 6.5$ mm.
- Protection: IP65.
- Power supply: 1 battery type V357.



909.458

Item No.	Measuring range/mm	Price EUR
909.458	0- 25	169.00
909.459	25- 50	198.00
Option:		
836.535	Spare battery	1.90

Micrometers with small measuring faces

For measuring hard-to-reach measuring points such as grooves.

- Measuring range: 0-175 mm.
- Analog: graduation 0.01 mm, digital: resolution 0.001 mm.
- Tungsten carbide measuring pins: $\varnothing 2 \times 5$ mm.

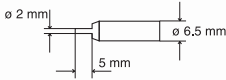

Digital

- mm/inch conversion.
- ABS/INC switchable.
- Reset/preset.
- Hold function.
- Preservation of the min/max value.
- Protection: IP65.
- Power supply: 1 battery type V357.



Analog

Item No.	Measuring range/mm	Accuracy mm	Price EUR
906.135	0- 25	± 0.004	47.00
906.136	25- 50	± 0.004	51.00
906.137	50- 75	± 0.005	55.00
906.119	75- 100	± 0.005	66.00
909.320	100- 125	± 0.006	79.00
909.321	125- 150	± 0.006	95.00
909.322	150- 175	± 0.007	114.00

Digital

Item No.	Measuring range/mm	Accuracy mm	Price EUR
909.591	0- 25	± 0.002	154.00
909.592	25- 50	± 0.002	164.00
909.593	50- 75	± 0.003	175.00
909.594	75- 100	± 0.003	185.00
909.595	100- 125	± 0.003	196.00
909.596	125- 150	± 0.003	203.00
909.597	150- 175	± 0.004	213.00

Option:

836.535 Spare battery 1.90



Micrometers with spherical anvil

Micrometers for measuring bent surfaces and wall thicknesses of tubes, bearings, rings, etc.

- Measuring range: 0- 100 mm.
 - Analog: graduation 0.01 mm, digital: resolution 0.001 mm.
 - Tungsten carbide measuring faces: $\varnothing 6.5$ mm.
- Digital**
- mm/inch conversion.
 - ABS/INC switchable.
 - On/off switch.
 - Automatic switch-off.
 - Reset/preset.
 - Protection: IP65.
 - Power supply: 1 battery type V357.

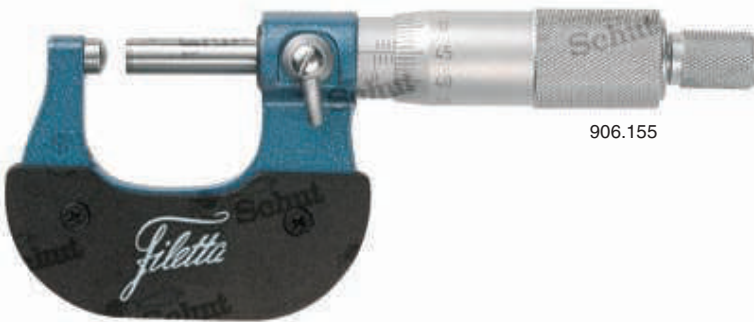

906.155



909.598

Analog

Item No.	Measuring range/mm	Accuracy mm	Price EUR
906.155	0- 25	± 0.004	23.30
907.044	25- 50	± 0.004	29.50
907.045	50- 75	± 0.005	49.00
907.046	75- 100	± 0.005	58.00

Digital

Item No.	Measuring range/mm	Accuracy mm	Price EUR
909.598	0- 25	± 0.002	136.00
909.599	25- 50	± 0.002	149.00
909.600	50- 75	± 0.003	164.00
909.601	75- 100	± 0.003	180.00
Option:			
836.535	Spare battery		1.90



Universal micrometers with interchangeable anvils

With these micrometers you are an all-rounder. The instruments have two interchangeable anvils, which gives them a lot of application possibilities. They can also be used as a height gauge, when the clamp for clamping the anvils is removed.

- Measuring range: 0-50 mm.
- Analog: graduation 0.01 mm, digital: resolution 0.001 mm.
- Accuracy: ± 0.004 mm.
- Tungsten carbide measuring face: $\varnothing 6.5$ mm.
- Delivery incl. 2 tungsten carbide anvils.

Digital

- mm/inch conversion.
- ABS/INC switchable.
- On/off switch.
- Reset/preset.
- Adjustable tolerance limits (only 909.508).
- Protection: IP65.
- Power supply: 1 battery type V357.



906.190

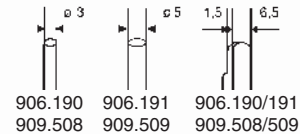

909.508

Analog

Item No.	Measuring range/mm	Price EUR
906.190	0-25	85.00
906.191	25-50	92.00

Digital

Item No.	Measuring range/mm	Price EUR
909.508	0-25	161.00
909.509	25-50	178.00

Option:

836.535	Spare battery	1.90
---------	---------------	------



Digital micrometers IP65 with pin-shaped anvil

Digital micrometers for measuring e.g. (tube) wall thickness.

- Measuring range: 0-50 mm.
- Resolution: 0.001 mm.
- mm/inch conversion.
- ABS/INC switchable.
- Automatic switch-off.
- Reset/preset.
- Pin-shaped anvil: \varnothing 1.8 mm.
- Tungsten carbide measuring face: \varnothing 6.5 mm.
- Protection: IP65.
- Power supply: 1 battery type V357.



909.684

PRICE

Item No.	Measuring range/mm	Accuracy mm	Price EUR
909.684	0-25	± 0.005	150.00
909.685	25-50	± 0.005	164.00
Option:			
836.535	Spare battery		1.90

Digital micrometers with special measuring jaws

Digital micrometers with special measuring jaws for measurements in hard-to-reach places such as cut-outs in workpieces, gear pitches, etc.

- Measuring range: 0-200 mm.
- Resolution: 0.001 mm.
- mm/inch conversion.
- ABS/INC switchable.
- Automatic switch-off.
- Reset/preset.
- Non-rotating spindle.
- Power supply: 1 battery type V357.



909.676

PRICE

Item No.	Measuring range/mm	Accuracy mm	Price EUR
909.676	0- 25	± 0.006	171.00
909.677	25- 50	± 0.006	185.00
909.678	50- 75	± 0.007	199.00
909.679	75-100	± 0.007	220.00
909.680	100-125	± 0.009	240.00
909.681	125-150	± 0.009	261.00
909.682	150-175	± 0.010	284.00
909.683	175-200	± 0.010	307.00
Option:			
836.535	Spare battery		1.90



Gear pitch micrometers

Micrometers with large, disk-shaped measuring faces for measuring e.g. gear pitches and paper and foil thickness.

- Measuring range: 0-200 mm.
- Analog: graduation 0.01 mm, digital: resolution 0.001 mm.
- Non-rotating spindle: $\varnothing 8$ mm.
- Measuring faces: stainless steel (HRC 52 - 54).

Digital

- mm/inch conversion.
- ABS/INC switchable.
- Automatic switch-off.
- Reset/preset.
- Power supply: 1 battery type V357.



Item No.	Measuring range/mm	Accuracy mm	Measuring faces \varnothing /mm	Price EUR
Analog:				
906.580	0- 25	± 0.006	20	104.00
906.581	25- 50	± 0.006	20	112.00
906.582	50- 75	± 0.007	20	115.00
906.583	75-100	± 0.007	20	123.00
906.584	100-125	± 0.009	30	137.00
906.585	125-150	± 0.009	30	147.00
906.586	150-175	± 0.010	30	158.00
906.587	175-200	± 0.010	30	168.00
Digital:				
909.777	0- 25	± 0.006	20	171.00
909.778	25- 50	± 0.006	20	185.00
909.779	50- 75	± 0.007	20	199.00
909.780	75-100	± 0.007	20	220.00
909.781	100-125	± 0.009	30	240.00
909.782	125-150	± 0.009	30	261.00
909.783	150-175	± 0.010	30	284.00
909.784	175-200	± 0.010	30	307.00
Option:				
836.535	Spare battery			1.90



Universal micrometers

Thanks to the seven interchangeable measuring inserts, which are available as an option, you are very flexible with these micrometers.

- Measuring range: 0-200 mm.
- Analog: graduation 0.01 mm, digital: resolution 0.001 mm.
- Non-rotating spindle.
- Insert shaft: $\varnothing 5$ mm.

Digital

- mm/inch conversion.
- ABS/INC switchable.
- On/off switch.
- Preset (except 909.785).
- Power supply: 1 battery type V357.

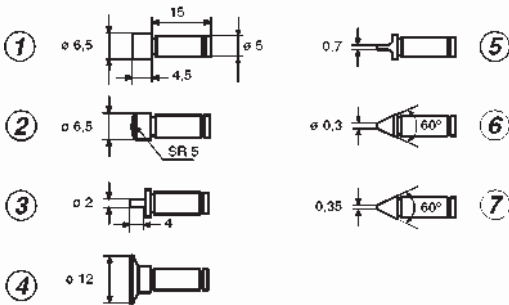

No.	Item No.	Description measuring faces	Price EUR
Measuring inserts, per pair:			
①	906.788	flat	13.10
②	906.789	spherical	15.70
③	906.790	small	23.30
④	906.791	disc	23.50
⑤	906.792	knife/flat	31.40
⑥	906.793	point	23.50
⑦	906.794	knife	30.80
	906.795	Set of 7 pairs	123.00

Item No.	Measuring range/mm	Accuracy mm	Price EUR
Analog, without measuring inserts:			
906.780	0- 25	± 0.004	67.00
906.781	25- 50	± 0.004	73.00
906.782	50- 75	± 0.005	82.00
906.783	75-100	± 0.005	88.00
906.784	100-125	± 0.008	105.00
906.785	125-150	± 0.008	118.00
906.786	150-175	± 0.009	120.00
906.787	175-200	± 0.009	142.00
Digital, without measuring inserts:			
909.785	0- 25	± 0.004	150.00
909.786	25- 50	± 0.004	157.00
909.787	50- 75	± 0.005	164.00
909.788	75-100	± 0.005	175.00
909.789	100-125	± 0.008	187.00
909.790	125-150	± 0.008	199.00
909.791	150-175	± 0.009	213.00
909.792	175-200	± 0.009	226.00
Option:			
836.535	Spare battery		1.90

Deep throat micrometers

Micrometers with a deep throat especially for measuring the thickness of e.g. sheet metal, paper and plastic sheets.

- Measuring range: 0-50 mm.
- Analog: graduation 0.01 mm, digital: resolution 0.001 mm.
- Tungsten carbide measuring faces: $\varnothing 6.5$ mm.

Digital

- mm/inch conversion.
- ABS/INC switchable.
- Automatic switch-off.
- Reset/preset.
- Protection: IP65.
- Power supply: 1 battery type V357.



907.068



909.694



Item No.	Measuring range/mm	Accuracy mm	Throat depth/mm	Price EUR
Analog:				
907.068	0-25	± 0.004	50	54.00
907.069	25-50	± 0.004	50	61.00
907.070	0-25	± 0.005	100	58.00
907.071	25-50	± 0.005	100	66.00
907.072	0-25	± 0.006	150	69.00
907.073	25-50	± 0.006	150	76.00
Digital:				
909.694	0-25	± 0.004	50	160.00
909.695	25-50	± 0.004	50	166.00
909.696	0-25	± 0.005	100	163.00
909.697	25-50	± 0.005	100	170.00
909.698	0-25	± 0.006	150	174.00
909.699	25-50	± 0.006	150	182.00
Option:				
836.535	Spare battery			1.90

Brake disc micrometers

Micrometers especially for measuring the groove depth of brake discs.

- Measuring range: 7.6 - 50 mm.
- Analog: graduation 0.01 mm, digital: resolution 0.001 mm.
- Anvil with 60° point.
- Tungsten carbide measuring face: $\varnothing 6.5$ mm.
- Throat depth: 88 mm.

Digital

- mm/inch conversion.
- ABS/INC switchable.
- Automatic switch-off.
- Reset/preset.
- Protection: IP65.
- Power supply: 1 battery type V357.



907.056



909.793

Analog

Item No.	Measuring range/mm	Accuracy mm	Price EUR
907.056	7.6-33	± 0.004	37.30
907.057	25 -50	± 0.004	53.00

Digital

Item No.	Measuring range/mm	Accuracy mm	Price EUR
909.793	7.6-33	± 0.004	143.00
909.794	25 -50	± 0.004	153.00
Option:			
836.535	Spare battery		1.90

Digital micrometers IP65 with large anvils

- Measuring range: 0 - 50 mm.
- Resolution: 0.001 mm.
- mm/inch conversion.
- ABS/INC switchable.
- On/off switch.
- On/reset switch.
- Tungsten carbide measuring face: $\varnothing 6.5$ mm.

NEW

- Anvil size:
909.488: 50 x 14 mm,
909.489: 60 x 14 mm.
- Protection: IP65.
- Power supply: 1 battery type V357.



909.488

Item No.	Measuring range/mm	Accuracy mm	Price EUR
909.488	0-25	± 0.004	213.00
909.489	25-50	± 0.004	245.00
Option:			
836.535	Spare battery		1.90

Sheet metal micrometers

Micrometers especially for measuring the thickness of metal sheets, e.g. sheet metal. The large dial makes the reading very easy and quick.

- Measuring range: 0-25 mm.
- Graduation: 0.01 mm.
- Tungsten carbide measuring faces: $\varnothing 6.5$ mm.



Item No.	Measuring range/mm	Accuracy mm	Measuring faces	Price EUR
907.058	0-15	± 0.004	flat/flat	59.00
907.059	0-25	± 0.004	flat/flat	68.00
907.099	0-15	± 0.004	spherical/flat	56.00
907.100	0-25	± 0.004	spherical/flat	68.00

Micrometers with extra large measuring faces

Micrometers with extra large disk-shaped measuring faces for measurements of e.g. paper thickness and soft materials.

- Measuring range: 0-100 mm.
- Graduation: 0.01 mm.
- Non-rotating spindle.
- Tungsten carbide measuring faces: $\varnothing 60$ mm.



Item No.	Measuring range/mm	Accuracy mm	Price EUR
906.588	0- 25	± 0.008	132.00
906.589	25- 50	± 0.008	142.00
906.590	50- 75	± 0.010	165.00
906.591	75-100	± 0.010	203.00

Gear micrometers

Micrometers with ball-tipped measuring faces for measurements of straight and tapered external gears. Several measuring inserts optionally available.

- Measuring range: 0- 175 mm.
- Analog: graduation 0.01 mm, digital: resolution 0.001 mm.
- Dimensions of anvil-tail: $\varnothing 5 \times 15$ mm.
- Tungsten carbide, ball-tipped measuring faces.

Digital

- mm/inch conversion.
- ABS/INC switchable.
- Automatic switch-off.
- Reset/preset.
- Protection: IP65.
- Power supply: 1 battery type V357.



907.081



909.859



Item No.	Ball \varnothing /mm	Module	Price EUR
Measuring inserts, per pair:			
907.088	1.0	0.6-0.65	51.00
907.089	1.5	0.9- 1.0	51.00
907.090	2.0	1.25	51.00
907.091	2.5	1.5	51.00
907.092	3.0	1.75	51.00
907.093	3.5	2	51.00
907.094	4.0	2.25	51.00
907.095	4.5	2.5	51.00
907.096	5.0	2.75	51.00
907.097	6.0	3.5	51.00
907.098	Set 907.088 - 907.097		460.00

Item No.	Measuring range/mm	Accuracy mm	Price EUR
Analog, without measuring inserts:			
907.081	0- 25	± 0.004	69.00
907.082	25- 50	± 0.004	77.00
907.083	50- 75	± 0.005	85.00
907.084	75-100	± 0.005	94.00
907.085	100-125	± 0.006	102.00
907.086	125-150	± 0.006	110.00
907.087	150-175	± 0.007	118.00
Digital, without measuring inserts:			
909.859	0- 25	± 0.004	157.00
909.860	25- 50	± 0.004	164.00
909.861	50- 75	± 0.005	171.00
909.862	75-100	± 0.005	178.00
909.863	100-125	± 0.006	185.00
909.864	125-150	± 0.006	192.00
909.865	150-175	± 0.007	199.00
Option:			
836.535	Spare battery		1.90



Micrometers with prism-shaped anvil

Analog and digital micrometers with prism-shaped anvil for measuring the diameters of objects with an odd number of flutes such as taps, reamers and mills. The angle of the prism aperture is designed for 3-, 5- or 7-fluted workpieces.

- Measuring range: 1 - 105 mm.
- Analog: graduation 0.01 mm, digital: resolution 0.001 mm.
- Spindle: $\varnothing 6.5$ mm.
- Tungsten carbide measuring faces. The 906.160 and 909.866 have a pointed spindle for the smallest objects.
- V-groove for:
 - 3-fluted objects: 60° ,
 - 5-fluted objects: 108° ,
 - 7-fluted objects: 128° .
- Delivery with a setting standard.

Digital

- mm/inch conversion.
- ABS/INC switchable.
- Automatic switch-off.
- Reset/preset.
- Protection: IP65.
- Power supply: 1 battery type V357.



Item No.	Measuring range/mm	Accuracy mm	Price EUR	Item No.	Price EUR
For 3-fluted objects (60°), analog:				Digital:	
906.160	1 - 15	± 0.004	117.00	909.866	213.00
906.161	5 - 20	± 0.004	122.00	909.867	218.00
906.162	20 - 35	± 0.005	146.00	909.868	238.00
906.163	35 - 50	± 0.005	180.00	909.869	268.00
906.164	50 - 65	± 0.006	193.00	909.870	271.00
906.165	65 - 80	± 0.006	209.00	909.871	285.00
907.060	80 - 95	± 0.007	225.00	909.872	299.00
For 5-fluted objects (108°), analog:				Digital:	
906.166	5 - 25	± 0.004	121.00	909.873	217.00
906.167	25 - 45	± 0.005	156.00	909.874	247.00
906.168	45 - 65	± 0.006	180.00	909.875	267.00
906.169	65 - 85	± 0.007	209.00	909.876	292.00
907.061	85 - 105	± 0.008	237.00	909.877	317.00
For 7-fluted objects (128°), analog:				Digital:	
906.170	5 - 25	± 0.004	121.00	909.878	217.00
906.171	25 - 45	± 0.005	156.00	909.879	247.00
906.172	45 - 65	± 0.006	167.00	909.880	267.00
906.173	65 - 85	± 0.007	209.00	909.881	292.00
Option:					
836.535	Spare battery				1.90



Setting standards

Item No.	\varnothing mm	Price EUR
909.323	5	9.10
909.324	20	26.70
909.325	25	29.40
909.326	35	31.40
909.327	45	32.70
909.328	50	37.90
909.329	65	54.00
909.330	80	72.00
909.331	85	78.00



Micrometers with pointed measuring faces

- Measuring range: 0 - 100 mm.
- Analog: graduation 0.01 mm, digital: resolution 0.001 mm.

Digital

- mm/inch conversion.
- ABS/INC switchable.
- Preset.
- Protection: IP65.
- Power supply: 1 battery type V357.



906.145

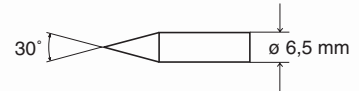

909.643



Analog

Item No.	Measuring range/mm	Accuracy mm	Price EUR
906.145	0 - 25	±0.004	47.00
906.146	25 - 50	±0.004	51.00
906.147	50 - 75	±0.005	55.00
906.199	75 - 100	±0.005	66.00

Digital

Item No.	Measuring range/mm	Accuracy mm	Price EUR
909.643	0 - 25	±0.004	154.00
909.644	25 - 50	±0.004	164.00
909.645	50 - 75	±0.005	175.00
909.646	75 - 100	±0.005	185.00
Option:			
836.535	Spare battery		1.90



Micrometers with one pointed measuring face

- Measuring range: 0 - 50 mm.
- Graduation: 0.01 mm.

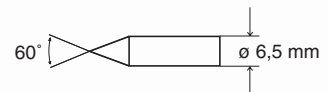

Item No.	Measuring range/mm	Accuracy mm	Price EUR
906.151	0 - 25	±0.004	47.00
906.153	25 - 50	±0.004	51.00



Micrometers with lamellar measuring faces

For measuring grooves, keyseats and other hard-to-reach places.

- Measuring range: 0- 175 mm.
- Analog: graduation 0.01 mm, digital: resolution 0.001 mm.
- Non-rotating spindle.
- Blade width: 0.75 mm, blade length: 6 mm.

Digital

- mm/inch conversion.
- ABS/INC switchable.
- Reset/preset.
- Hold function.
- Power supply: 1 battery type V357.



906.141

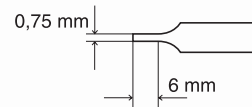

909.882

Analog

Item No.	Measuring range/mm	Accuracy mm	Price EUR
906.141	0- 25	±0.004	99.00
906.142	25- 50	±0.004	107.00
906.143	50- 75	±0.005	115.00
906.144	75- 100	±0.005	127.00
906.222	100- 125	±0.006	138.00
906.223	125- 150	±0.006	150.00
906.224	150- 175	±0.007	163.00

Digital

Item No.	Measuring range/mm	Accuracy mm	Price EUR
909.882	0- 25	±0.004	175.00
909.883	25- 50	±0.004	185.00
909.884	50- 75	±0.005	196.00
909.885	75- 100	±0.005	210.00
909.886	100- 125	±0.006	220.00
909.887	125- 150	±0.006	231.00
909.888	150- 175	±0.007	241.00

Option:

836.535 Spare battery 1.90



Screw thread micrometers

- Measuring range: 0 - 200 mm.
- Analog: graduation 0.01 mm, digital: resolution 0.001 mm.
- Insert shaft: $\varnothing 5$ mm.
- DIN 863 T3.
- Delivery incl. adjustment tools.
- From measuring range 25 - 50 mm including setting gauge 60° .
- No-glare chrome finished thimble.

Digital

- mm/inch conversion.
- ABS/INC switchable.
- On/off switch.
- Reset/preset.
- Protection: IP65.
- Power supply: 1 battery type V357.



906.751



909.889

Analog, without measuring inserts

Item No.	Measuring range/mm	Accuracy mm	Price EUR
906.750	0 - 25	± 0.004	70.00
906.751	25 - 50	± 0.004	77.00
906.752	50 - 75	± 0.005	90.00
906.753	75 - 100	± 0.005	98.00
906.754	100 - 125	± 0.006	112.00
906.755	125 - 150	± 0.006	126.00
906.756	150 - 175	± 0.007	139.00
906.757	175 - 200	± 0.007	153.00

Digital, without measuring inserts

Item No.	Measuring range/mm	Accuracy mm	Price EUR
909.889	0 - 25	± 0.004	126.00
909.890	25 - 50	± 0.004	136.00
909.891	50 - 75	± 0.005	147.00
909.892	75 - 100	± 0.005	160.00
909.893	100 - 125	± 0.006	235.00
909.894	125 - 150	± 0.006	255.00
909.895	150 - 175	± 0.007	278.00
909.896	175 - 200	± 0.007	304.00

Option:

836.535	Spare battery	1.90
---------	---------------	------



Screw thread micrometers (continued)



Item No.	Threads per inch	Price EUR
Measuring inserts for Whitworth threads, 55° flank angle, per pair:		
906.730	60 -48	19.60
906.731	48 -40	19.60
906.732	40 -32	19.60
906.733	32 -24	19.60
906.734	24 -18	19.60
906.735	18 -14	19.60
906.736	14 -10	19.60
906.737	10 - 7.0	19.60
906.738	7.0- 4.5	19.60
906.739	4.5- 3.5	19.60
906.740	Set 60-3.5	153.00

Item No.	Pitch/mm	Price EUR
Measuring inserts for metric threads, 60° flank angle, per pair:		
906.720	0.4 -0.5	19.60
906.721	0.6 -0.9	19.60
906.722	1.0 -1.75	19.60
906.723	2.0 -3.0	19.60
906.724	3.5 -5.0	19.60
906.725	5.5 -7.0	19.60
906.726	Set 0.4-7.0	87.00

Item No.	Threads per inch	Price EUR
Measuring inserts for UN, UNC and UNF threads, 60° flank angle, per pair:		
906.741	64 -48	19.60
906.742	44 -28	19.60
906.743	24 -14	19.60
906.744	13 - 9	19.60
906.745	8 - 5	19.60
906.746	4.5- 3.5	19.60
906.747	Set 64-3.5	92.00



909.305



Item No.	Length/mm	Price EUR
Hardened steel setting standards for threads with 60° flank angle:		
909.304	25	30.60
909.305	50	35.20
909.306	75	40.00
909.307	100	46.00
909.308	125	54.00
909.309	150	61.00
909.310	175	70.00
909.311	200	75.00

Item No.	Length/mm	Price EUR
Hardened steel setting standards for threads with 55° flank angle:		
909.312	25	30.60
909.313	50	35.20
909.314	75	40.00
909.315	100	46.00
909.316	125	54.00
909.317	150	61.00
909.318	175	70.00
909.319	200	81.00

Thread measuring wires

For measuring external threads using the three-wire method. The flank diameter can be determined according to the measured diameter, using tables.

- For micrometers with measuring faces $\phi 6.35$, $\phi 6.5$ or $\phi 8$ mm. (Also available for measuring faces $\phi 6.8$ and $\phi 7.5$ mm.)
- Very high measuring accuracy: ± 0.001 mm.
- In pairs or in a set.
- The wire holders are held in position on the anvil and spindle by a spring clamp.
- The wires are mounted on the holder in such a way that they position themselves on the thread.

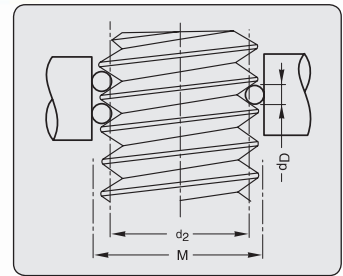

Thread measuring wires for micrometers with measuring faces $\phi 6.35$, $\phi 6.5$ or $\phi 8$ mm

$\phi 6.35$ mm		$\phi 6.5$ mm		$\phi 8$ mm		Wire diameter d_w /mm	Metric, pitch in mm	Whitworth, threads per inch	UN/UNC/UNF, threads per inch
Item No.	Price EUR	Item No.	Price EUR	Item No.	Price EUR				
833.442	128.00	779.161	128.00	836.689	128.00	0.17	0.25; 0.3	–	–
833.443	128.00	781.651	128.00	836.690	128.00	0.195	–	–	80
833.444	128.00	779.162	128.00	836.691	128.00	0.22	0.35	–	72
833.445	128.00	779.163	128.00	835.844	128.00	0.25	0.4	–	64
833.446	128.00	779.164	128.00	834.499	128.00	0.29	0.45; 0.5	–	56
833.447	128.00	779.165	128.00	834.498	128.00	0.335	0.6	40	48; 44
833.448	128.00	781.652	128.00	837.848	128.00	0.390	–	–	40
833.449	128.00	779.166	128.00	833.872	128.00	0.455	0.7-0.8	–	36
833.450	128.00	779.167	128.00	834.585	128.00	0.53	–	32; 28	32; 28
833.451	128.00	779.168	128.00	834.480	128.00	0.62	1	26; 24	24
833.452	128.00	779.169	128.00	834.586	128.00	0.725	1.25	22; 20; 19	20
833.453	128.00	779.170	128.00	834.290	128.00	0.895	1.5	18; 16	18; 16
833.454	128.00	779.171	128.00	834.502	128.00	1.10	1.75	14	14; 13
833.455	128.00	779.172	128.00	834.291	128.00	1.35	2	12; 11	12; 11
833.456	128.00	779.173	128.00	833.871	128.00	1.65	2.5	10; 9	10; 9
833.457	128.00	779.174	128.00	834.292	128.00	2.05	3.0; 3.5	8; 7	8; 7
833.458	128.00	779.175	128.00	834.416	128.00	2.55	4.0; 4.5	6	6
833.459	128.00	779.176	128.00	834.483	128.00	3.20	5.0; 5.5	5; 4.5	5; 4.5
837.501	400.00	837.642	400.00	834.509	400.00	4.00	6.0	4; 3.5	4
834.580	2,370.00	779.160	2,370.00	834.581	2,370.00	Set with wire diameters 0.17 to 3.20 mm			

Hub micrometers

Micrometers with a shallow bracket for measuring the thickness bearing bushes, bore shoulders and other hard-to-reach places.

- Measuring range: 0- 100 mm.
- Graduation: 0.01 mm.
- Tungsten carbide measuring faces: $\varnothing 6.5$ mm.
- Varnished frame.
- Throat depth: 10.2 mm.
- Throat height: 21.2 mm (907.133: 18.7 mm).



907.133



Item No.	Measuring range/mm	Accuracy mm	Price EUR
907.133	0- 25	± 0.004	50.00
907.134	25- 50	± 0.004	62.00
907.135	50- 75	± 0.004	67.00
907.136	75- 100	± 0.005	70.00

Can seam micrometer

Micrometer especially for measuring the depth and thickness of e.g. the seams of steel cans.

- Measuring range: 0- 13 mm.
- Graduation: 0.01 mm.
- Accuracy: ± 0.004 mm.
- Tungsten carbide measuring faces: $\varnothing 5$ mm.



Item No.	Measuring range/mm	Price EUR
907.175	0- 13	51.00



Wire and ball micrometer

- Measuring range: 0- 10 mm.
- Graduation: 0.01 mm.
- Accuracy: ± 0.004 mm.
- Tungsten carbide measuring faces: $\varnothing 6.5$ mm.



Item No.	Measuring range/mm	Price EUR
906.175	0- 10	51.00



Mitutoyo special-purpose micrometers

Mitutoyo special-purpose analog and digital micrometers. For more information please contact our sales department.



Item No.	Measuring range/mm	Read-out ¹ mm	Price EUR
With small measuring faces $\varnothing 3$ mm:			
111.115	0- 25	0.01 (A)	194.00
111.116	25- 50	0.01 (A)	237.00
111.117	50- 75	0.01 (A)	270.00
111.118	75-100	0.01 (A)	288.00
331.251 ²	0- 25	0.001 (D)	648.00
331.252 ²	25- 50	0.001 (D)	703.00
331.253 ²	50- 75	0.001 (D)	750.00
331.254 ²	75-100	0.001 (D)	782.00
With small measuring faces $\varnothing 2$ mm:			
111.215	0- 25	0.01 (A)	194.00
331.261 ²	0- 25	0.001 (D)	648.00
331.262 ²	25- 50	0.001 (D)	703.00
331.263 ²	50- 75	0.001 (D)	750.00
331.264 ²	75-100	0.001 (D)	782.00
With prism-shaped anvil (with grooves):			
114.101	1- 15	0.01 (A)	328.00
114.102	10- 25	0.01 (A)	386.00
314.251	1- 15	0.001 (D)	820.00
314.252	10- 25	0.001 (D)	857.00
With prism-shaped anvil (without grooves):			
114.161	1- 15	0.01 (A)	308.00
114.204 ³	2.3- 25	0.01 (A)	451.00
114.162	10- 25	0.01 (A)	379.00
114.103	25- 40	0.01 (A)	393.00
314.261	1- 15	0.001 (D)	820.00
314.262	10- 25	0.001 (D)	857.00
314.253	25- 40	0.001 (D)	879.00



¹ A = analog read-out, D = digital read-out.

² Digimatic Coolant Proof (IP65) model.

³ With tungsten carbide measuring faces.



Item No.	Measuring range/mm	Read-out ¹ mm	Price EUR
With pointed measuring faces 15°:			
112.153	0- 25	0.01 (A)	194.00
112.154	25- 50	0.01 (A)	237.00
342.251 ²	0- 25	0.001 (D)	611.00
342.252 ²	25- 50	0.001 (D)	685.00
342.253 ²	50- 75	0.001 (D)	723.00
342.254 ²	75-100	0.001 (D)	761.00
With pointed measuring faces 30°:			
112.201	0- 25	0.01 (A)	194.00
112.202	25- 50	0.01 (A)	237.00
342.261 ²	0- 25	0.001 (D)	611.00
342.262 ²	25- 50	0.001 (D)	685.00
342.263 ²	50- 75	0.001 (D)	723.00
342.264 ²	75-100	0.001 (D)	761.00
With pointed measuring face and lamellar anvil:			
112.401	0- 25	0.01 (A)	243.00
342.271 ²	0- 20	0.001 (D)	573.00
With lamellar measuring faces:			
122.101	0- 25	0.01 (A)	260.00
122.102	25- 50	0.01 (A)	315.00
122.103	50- 75	0.01 (A)	337.00
122.104	75-100	0.01 (A)	366.00
122.105	100-125	0.01 (A)	478.00
122.106	125-150	0.01 (A)	516.00
122.107	150-175	0.01 (A)	564.00
122.108	175-200	0.01 (A)	622.00
422.230	0- 25	0.001 (D)	932.00
422.231	25- 50	0.001 (D)	1,012.00
422.232	50- 75	0.001 (D)	1,051.00
422.233	75-100	0.001 (D)	1,087.00

Mitutoyo special-purpose micrometers (continued)

Item No.	Measuring range/mm	Read-out ¹ mm	Price EUR
With disk-shaped measuring faces for gear pitch measurements:			
123.101	0 - 25	0.01 (A)	217.00
123.102	25 - 50	0.01 (A)	243.00
123.103	50 - 75	0.01 (A)	268.00
123.104	75 - 100	0.01 (A)	312.00
123.105	100 - 125	0.01 (A)	328.00
123.106	125 - 150	0.01 (A)	347.00
123.107	150 - 175	0.01 (A)	371.00
123.108	175 - 200	0.01 (A)	401.00
123.109	200 - 225	0.01 (A)	411.00
123.110	225 - 250	0.01 (A)	424.00
123.111	250 - 275	0.01 (A)	446.00
123.112	275 - 300	0.01 (A)	465.00
323.250 ²	0 - 25	0.001 (D)	680.00
323.251 ²	25 - 50	0.001 (D)	756.00
323.252 ²	50 - 75	0.001 (D)	804.00
323.253 ²	75 - 100	0.001 (D)	835.00
With non-rotating spindle and disk-shaped measuring faces for soft materials:			
169.101	0 - 25	0.01 (A)	282.00
169.201 ³	0 - 25	0.01 (A)	303.00
369.250 ³	0 - 25	0.001 (D)	793.00
369.251 ³	25 - 50	0.001 (D)	868.00
369.252 ³	50 - 75	0.001 (D)	905.00
369.253 ³	75 - 100	0.001 (D)	949.00
Universal, with interchangeable anvils:			
117.101	0 - 25	0.01 (A)	270.00
117.102	25 - 50	0.01 (A)	341.00
317.251 ²	0 - 25	0.001 (D)	578.00
317.252 ²	25 - 50	0.001 (D)	643.00
With measuring jaws for hard-to-reach places:			
143.101	0 - 25	0.01 (A)	316.00
143.102	25 - 50	0.01 (A)	334.00
143.103	50 - 75	0.01 (A)	398.00
143.104	75 - 100	0.01 (A)	419.00
343.250	0 - 25	0.001 (D)	745.00
343.251	25 - 50	0.001 (D)	798.00
343.252	50 - 75	0.001 (D)	842.00
343.253	75 - 100	0.001 (D)	879.00
With exchangeable ball inserts for external gears⁴:			
224.251 ²	0 - 25	0.001 (D)	835.00
224.252 ²	25 - 50	0.001 (D)	852.00
224.253 ²	50 - 75	0.001 (D)	873.00
224.254 ²	75 - 100	0.001 (D)	895.00

¹ A = analog read-out, D = digital read-out.

² Digimatic Coolant Proof (IP65) model.



Item No.	Measuring range/mm	Read-out ¹ mm	Price EUR
For thread measurements (pitch diameters)⁴:			
126.125	0 - 25	0.01 (A)	300.00
126.126	25 - 50	0.01 (A)	360.00
126.127	50 - 75	0.01 (A)	400.00
126.128	75 - 100	0.01 (A)	423.00
126.129	100 - 125	0.01 (A)	439.00
126.130	125 - 150	0.01 (A)	530.00
326.251 ²	0 - 25	0.001 (D)	697.00
326.252 ²	25 - 50	0.001 (D)	873.00
326.253 ²	50 - 75	0.001 (D)	895.00
326.254 ²	75 - 100	0.001 (D)	942.00

³ Offset measuring faces.

⁴ Measuring inserts separately available.

TESA special-purpose micrometers

TESA special-purpose analog and digital micrometers. For more information please contact our sales department.



782.126



Item No.	Measuring range/mm	Read-out ¹ mm	Price EUR
With spherical anvil and flat spindle:			
782.126 ²	0- 30	0.001 (D)	598.00
With small measuring faces $\varnothing 2$ mm:			
779.087	0- 25	0.01 (A)	382.00
782.111 ²	0- 30	0.001 (D)	686.00
With non-rotating spindle and disk-shaped measuring faces for gear pitch measurements:			
779.089	0- 25	0.01 (A)	466.00
779.090	25- 50	0.01 (A)	482.00
779.091	50- 75	0.01 (A)	544.00
779.092	75-100	0.01 (A)	590.00
782.512	0- 30	0.001 (D)	1,471.00
782.513	25- 55	0.001 (D)	1,522.00
782.514	55- 85	0.001 (D)	1,570.00
782.515	85-115	0.001 (D)	1,624.00
For tube wall thickness measurements:			
782.609	0- 25	0.01 (A)	397.00
With retractable anvil:			
782.243	0- 25	0.002 (V)	1,291.00
With retractable anvil and precision dial indicator:			
781.770	0- 25	0.001 (C)	1,210.00
781.771	25- 50	0.001 (C)	1,316.00

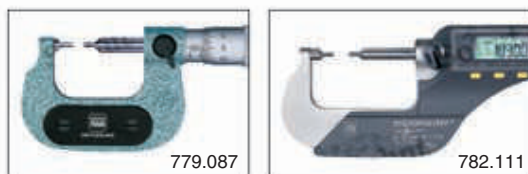

779.087

782.111



779.089

782.512



782.609

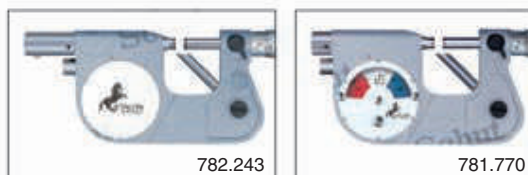

782.243

781.770

¹ A = analog read-out, V = vernier read-out, C = dial read-out, D = digital read-out.

² Model with IP54 protection (IP40 when using data output).

TESA special-purpose micrometers (continued)



Item No.	Measuring range/mm	Read-out ¹ mm	Price EUR
For interchangeable measuring inserts²:			
782.502 ³	0-30	0.001 (D)	1,223.00
Interchangeable measuring inserts, per pair:			
782.505	flat ϕ 6.5 mm		46.00
782.506	flat, small ϕ 2 mm		54.00
782.507	flat, large ϕ 12 mm		54.00
782.508	flat, narrow 0.7 mm		54.00
782.509	knife-edged 0.1 mm/60°		63.00
782.510	spherical R=5 mm		46.00
782.511	cone-shaped ϕ 0.3 mm/60°		54.00
782.504	Set 782.505 - 782.511		234.00

Item No.	Measuring range/mm	Read-out ¹ mm	Price EUR
Screw thread micrometers^{2,4}:			
779.081	0- 25	0.01 (A)	463.00
779.082	25- 50	0.01 (A)	503.00
779.083	50- 75	0.01 (A)	583.00
779.084	75-100	0.01 (A)	654.00
782.183 ³	0- 25	0.001 (D)	941.00
782.184 ³	25- 50	0.001 (D)	967.00
782.185 ³	50- 75	0.001 (D)	1,000.00
782.186 ³	75-100	0.001 (D)	1,047.00
782.187 ³	100-125	0.001 (D)	969.00



Item No.	Measuring range/mm	Read-out ¹ mm	Price EUR
Measuring inserts for metric⁵ threads, 60° flank angle, per pair (pitch in mm):			
779.137	0.4 -0.5		88.00
779.138	0.5 -0.6		88.00
779.139	0.6 -0.8		88.00
779.140	0.8 -1.0		88.00
779.141	1.0 -1.25		88.00
779.142	1.25-1.5		88.00
779.143	1.5 -2.0		88.00
779.144	2.0 -2.5		88.00
779.145	2.5 -3.0		88.00
779.146	3.0 -4.0		88.00
779.147	4.0 -5.0		88.00
779.148	5.0 -6.0		88.00
779.149	Set 0.4-6.0		827.00

Item No.	Measuring range/mm	Read-out ¹ mm	Price EUR
With prism-shaped anvil⁴ (V-angle 60°, for 3-fluted objects):			
782.189 ³	1- 7	0.001 (D)	1,158.00
782.190 ³	5- 20	0.001 (D)	1,136.00
782.191 ³	20-35	0.001 (D)	1,171.00
782.192 ³	35-50	0.001 (D)	1,244.00
782.193 ³	50-65	0.001 (D)	1,319.00
782.194 ³	65-80	0.001 (D)	1,369.00
With prism-shaped anvil⁴ (V-angle 108°, for 5-fluted objects):			
782.195 ³	1- 7	0.001 (D)	1,100.00
782.196 ³	5- 25	0.001 (D)	1,136.00
782.197 ³	25-45	0.001 (D)	1,171.00
782.198 ³	45-65	0.001 (D)	1,244.00
782.199 ³	65-85	0.001 (D)	1,369.00



¹ A = analog read-out, D = digital read-out.
² Instrument without measuring inserts.
³ Model with IP54 protection (IP40 when using data output).
⁴ Setting standards are separately available.
⁵ Inserts for Whitworth threads and for UN, UNC and UNF threads are also available.

Setting gauges

Cylindrical gauges for micrometers with flat parallel measuring faces.

- Measuring faces $L < 100$ mm: $\varnothing 7$ mm, flat,
 $L < 300$ mm: $\varnothing 8$ mm, flat,
 $L \geq 300$ mm: $\varnothing 8$ mm, spherical.
- With plastic insulating grip.
- Larger sizes available on request.



907.464



Setting standards

Cylindrical setting standards for micrometers with prism-shaped anvil.



909.326



Item No.	Length mm	Accuracy μm	Price EUR
907.464	25	± 2	3.40
907.465	50	± 2	3.90
907.466	75	± 2.5	4.90
907.467	100	± 2.5	6.40
907.468	125	± 3	7.80
907.469	150	± 3	8.80
907.470	175	± 3.5	10.30
907.471	200	± 4	11.80
907.472	225	± 4	13.10
907.473	250	± 4	15.00
907.474	275	± 4.5	16.30
907.475	300	± 4.5	32.00
907.476	325	± 5	32.00
907.477	350	± 5	38.40
907.478	375	± 5.5	32.00
907.479	400	± 5.5	38.40
907.480	425	± 6	34.00
907.481	450	± 6	41.00
907.482	475	± 6.5	41.00
907.483	500	± 6.5	41.00
907.484	525	± 7	42.00
907.485	575	± 7.5	42.00
907.486	625	± 7.5	50.00
907.487	675	± 8	50.00
907.488	725	± 8.5	56.00
907.489	775	± 9.5	56.00
907.490	825	± 10	65.00
907.491	875	± 10.5	65.00
907.492	925	± 11	78.00
907.493	975	± 11.5	78.00
907.494	1050	± 12	86.00
907.495	1150	± 13	110.00
907.496	1250	± 14	132.00
907.497	1350	± 15	132.00
907.498	1450	± 16	158.00
909.529	1550	± 17	158.00
909.530	1650	± 18	190.00
909.531	1750	± 19	190.00
909.532	1850	± 20	227.00
909.533	1950	± 21	227.00

Item No.	Diameter/mm	Price EUR
909.323	5	9.10
909.324	20	26.70
909.325	25	29.40
909.326	35	31.40
909.327	45	32.70
909.328	50	37.90
909.329	65	54.00
909.330	80	72.00
909.331	85	78.00

Setting standards

Hardened steel setting standards for threads with 55° or 60° flank angle.

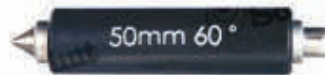

909.305



Item No.	Length/mm	Price EUR
For threads with 60° flank angle:		
909.304	25	30.60
909.305	50	35.20
909.306	75	40.00
909.307	100	46.00
909.308	125	54.00
909.309	150	61.00
909.310	175	70.00
909.311	200	75.00
For threads with 55° flank angle:		
909.312	25	30.60
909.313	50	35.20
909.314	75	40.00
909.315	100	46.00
909.316	125	54.00
909.317	150	61.00
909.318	175	70.00
909.319	200	81.00

Micrometer stand

Rigid table stand for micrometers.

- Inclination adjustable.
- Weight: 1.1 kg.



Item No.	Clamping range/mm	Price EUR
906.212	0 - 18	13.30

Micrometer stand

Cast steel stand for micrometers.

- Fixed inclination: 45°.
- Weight: 0.7 kg.



Item No.	Clamping range/mm	Price EUR
908.983	4 - 12	17.80

Foldable micrometer stand

Portable stand with a folded structure for micrometers.



Item No.	Clamping range/mm	Price EUR
907.152	7 - 14	22.50

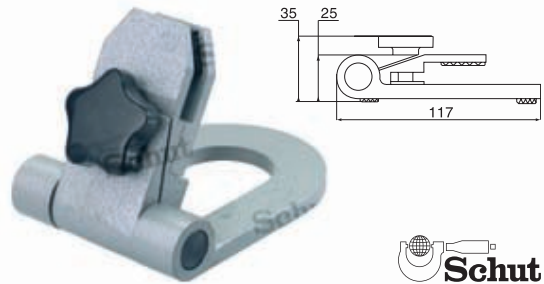

Ball attachments

These ball attachments can be clamped on any anvil and spindle with a diameter of 6.5 or 8 mm.

- Ball: $\varnothing 5$ mm.



Item No.	Description	Price EUR
907.150	Ball attachment, $\varnothing 6.5$ mm	15.30
907.166	Ball attachment, $\varnothing 8$ mm	15.30

Measuring force indicators

Within the range of 5 to 12 N these measuring force indicators can show the measuring force of micrometers.



Item No.	For micrometers	Price EUR
907.151	0 - 25 mm	9.20
908.947	25 - 50 mm	10.90
908.948	50 - 75 mm	12.00
908.949	75 - 100 mm	12.00

Probe set for micrometers

These attachments can be clamped on any anvil and spindle with a diameter of 6.5 mm. The set consists of a point-shaped, knife-edged, blade-shaped, disk-shaped, ball-shaped probe and one with a small and one with a very small measuring face.

- Delivery in a case.



Item No.	Description	Price EUR
909.118	Probe set for micrometers	20.20



Micrometer inspection sets

For the inspection of micrometers according DIN 863. Suitable for micrometers with a measuring range up to 25 mm.

- Nominal sizes (mm):
2.5 - 5.1 - 7.7 - 10.3 - 12.9 - 15.0 - 17.6 - 20.2 - 22.8 - 25.0.
- Including plan parallel optical flat $\varnothing 30 \times 12$ mm.



Item No.	Material	Grade	Price EUR
909.346	steel	1	201.00
909.345	steel	0	267.00
909.162	ceramic	1	432.00
909.340	ceramic	0	499.00



909.340

Thread and tolerance tables

Thread table

Table with all standard international thread indications: metric, Ww, Gas, BSF, Pg, BA, UNC, UNF and UNEF.

Tolerance table

Table comprising all tolerances and fits according ISO R286, up to 500 mm (table with over 6400 pairs of tolerance values for internal and external measurements).

Conversion table mm/inch

For converting from mm to inch and from inch to mm.

Item No.	Description	Price EUR
835.162	Thread table	39.90
835.163	Tolerance table	39.90
835.164	Conversion table mm/inch	39.90

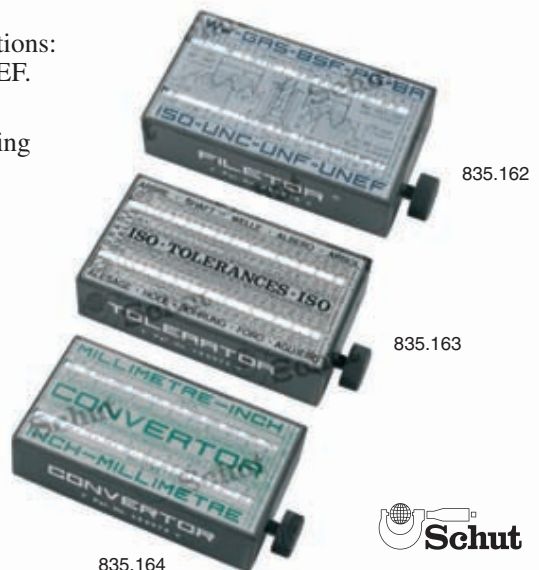

835.164



TESA setting gauges

Cylindrical gauges of hardened and lapped steel for micrometers with flat parallel measuring faces. All rods have one flat and one spherical face.

- Measuring faces $L < 200$ mm: $\varnothing 10$ mm,
 $L \geq 200$ mm: $\varnothing 13$ mm.
- No-glare chrome finished rod with plastic insulating grip.

Guide collars

Plastic grips for better positioning of the setting gauges. Suitable for setting gauges with measuring faces $\varnothing 8$ mm.



Mitutoyo micrometer inspection sets

These sets are composed for the inspection of micrometers according to DIN 863. Micrometers with a measuring range over 25 mm can be inspected if an extra gauge block of 25, 50 or 75 mm is used in addition to the gauge blocks in these sets. Each set consists of ten special gauge blocks and a plan parallel optical flat.

- Nominal sizes (mm):
2.5-5.1-7.7-10.3-12.9-15.0-17.6-20.2-22.8-25.0.
- Including plan parallel optical flat $\varnothing 30 \times 12$ mm.

516.156

Item No.	Material	Grade	Price EUR
516.107	steel	1	504.00
516.106	steel	0	578.00
516.157	ceramic	1	770.00
516.156	ceramic	0	968.00



Etalon stepped setting gauges

For adjusting micrometers.

- Made of hardened steel.
- Gauge steps of: $\varnothing 5 - 50$ mm: 5 mm,
 $\varnothing 50 - 150$ mm: 10 mm.
- Accuracy: $\varnothing 5 - 80$ mm: 0.0015 mm,
 $\varnothing 90 - 120$ mm: 0.0020 mm,
 $\varnothing 130 - 150$ mm: 0.0025 mm.
- Delivery: mounted on base with a protection cover.
- Delivery with a declaration of conformity.

Item No.	Measuring range/mm	Price EUR
781.810	5-100	2,169.00
781.811	5-150	2,879.00



781.811

Micrometer head with counter

Micrometer head with an easy read-out at 0.01 mm by means of the counter mechanism.

- Measuring range: 0-25 mm.
- Resolution: 0.01 mm.
- Accuracy: ±0.003 mm.
- Numerical counter adjustable.
- Rotating spindle: ø6.5 mm.
- Tungsten carbide measuring face.
- Delivery with adjustment tool.

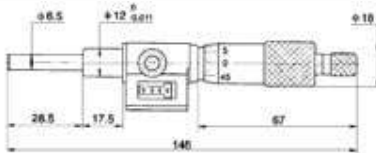

Item No.	Measuring range/mm	Spindle ø/mm	Price EUR
906.543	0-25	6.5	22.80

Micrometer heads

- Measuring range: 0-25 mm.
- Graduation: 0.01 mm or vernier 0.002 mm.



906.072

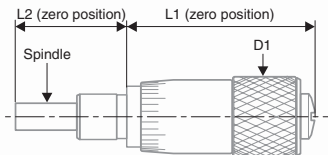

906.070



Item No.	Measuring range/mm	Graduation mm	Accuracy mm	Spindle ø/mm	Dimensions/mm clamping	D1	L1	L2	Price EUR
Without friction thimble, steel measuring face:									
906.070	0- 6.5	0.01	±0.005	3.5 (flat)	ø 6 x 6	ø10	23	14	14.00
906.074	0- 6.5	0.01	±0.005	3.5 (spherical)	ø 6 x 6	ø10	23	14	12.60
906.071	0- 13	0.01	±0.004	5.0 (flat)	ø 9.5x 9.5	ø14	33	26	15.00
Friction thimble with spring click in measuring thimble, tungsten carbide measuring face:									
906.072	0-25	0.01	±0.003	6.5 (flat)	ø12 x17	ø19	65	46	16.20
906.073	0-25	0.002	±0.003	6.5 (flat)	ø12 x17	ø19	65	46	15.70

Digital micrometer heads

Several digital micrometer heads with different possibilities.

- Measuring range: 0-50 mm.
- Resolution: 0.001 mm.
- Accuracy: ± 0.003 mm (909.900/901: ± 0.005 mm).
- mm/inch conversion.
- ABS/INC switchable.
- On/off switch.
- Automatic switch-off.

- Memory absolute measuring value.
- Preset for ABS measurement.
- Friction thimble.
- Power supply: 1 battery type V357.

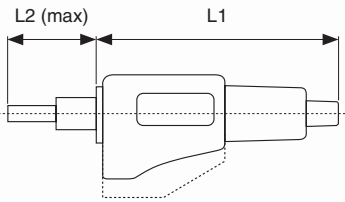

906.297



909.897

NEW



Item No.	Measuring range/mm	Dimensions/mm				Description measuring faces	Price EUR
		spindle	clamping	L1	L2		
With IP65 protection:							
909.897	0-25	$\phi 6.5$	$\phi 12 \times 17.5$	115	46	flat, tungsten carbide measuring face	105.00
909.898	0-25	$\phi 6.5$	$\phi 12 \times 17.5$	115	46	spherical	105.00
909.899	0-25	$\phi 6.5$	$\phi 12 \times 17.5$	116	56	flat, non-rotating tip	107.00
909.900	0-50	$\phi 7.5$	$\phi 12 \times 35.5$	140	89	flat, tungsten carbide measuring face	168.00
909.901	0-50	$\phi 7.5$	$\phi 12 \times 35.5$	140	89	spherical	168.00
With non-rotating spindle:							
909.902	0-25	$\phi 7.5$	$\phi 12 \times 10$	124	39	flat, tungsten carbide measuring face	136.00
909.903	0-25	$\phi 7.5$	$\phi 12 \times 10$	123	39	interchangeable measuring inserts	140.00
906.297	0-25	$\phi 6.5$	$\phi 12 \times 17.5$	98	48	tungsten carbide measuring face	67.00
906.298	0-25	$\phi 8$	$\phi 12 \times 20$	98	50	tungsten carbide measuring face	80.00
Option:							
836.535	Spare battery						1.90

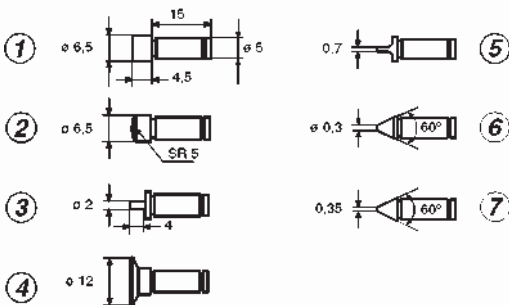

No.	Item No.	Description measuring faces	Price EUR
Measuring inserts, per pair:			
①	906.788	flat	13.10
②	906.789	spherical	15.70
③	906.790	small	23.30
④	906.791	disc	23.50
⑤	906.792	knife/flat	31.40
⑥	906.793	point	23.50
⑦	906.794	knife	30.80
	906.795	Set of 7 pairs	123.00

TESA micrometer heads

TESA micrometer heads serve as built-in components on measuring systems, microscopes and other measuring instruments.

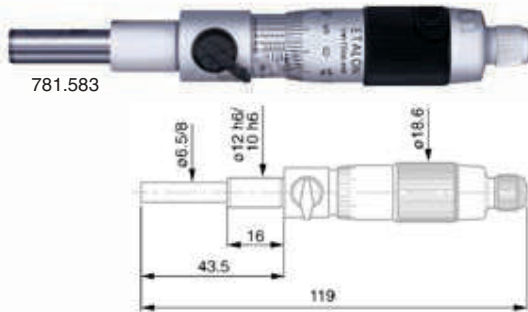

- Measuring range: 0 - 30 mm.
- Clamping stem: \varnothing 12h6 mm (length: 16 mm).
- Tungsten carbide measuring face.
- Locking screw (only 781.583).
- DIN 863 T2.
- Delivery in a case.

Digital

- Resolution: 0.001 mm.
- mm/inch conversion.
- ABS/INC switchable.
- Opto-RS232C data output.
- Automatic switch-off.
- Reset/preset.
- Delivery with an inspection report and a declaration of conformity.
- Power supply: 1 battery type CR2032.



ISOMASTER

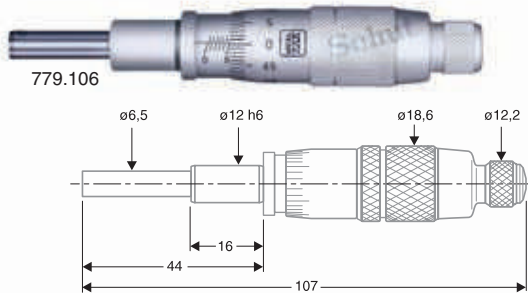

TESAMASTER

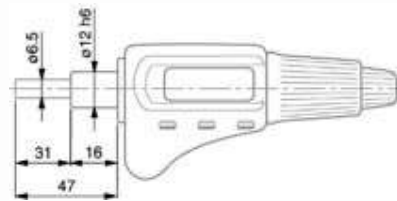
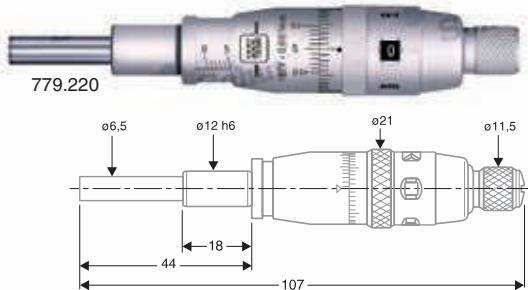

Item No.	Type	Measuring range/mm	Graduation mm	Accuracy mm	Spindle \varnothing /mm	Mounting	Price EUR
781.583	Etalon	0-25	0.002	± 0.003	8	–	255.00
779.106	Isomaster	0-25	0.01	± 0.003	6.5	–	175.00
779.220	Tesamaster	0-25	0.001	± 0.002	6.5	–	289.00
Digital:							
782.109	Micromaster	0-30	0.001	± 0.003	6.5	right-left	407.00
782.110	Micromaster	30-0	0.001	± 0.003	6.5	right-left	417.00
782.142	Micromaster	30-0	0.001	± 0.003	6.5	left-right	450.00
Option:							
495.157	Spare battery						0.50

Mitutoyo micrometer heads

- Measuring range: 0-25 mm.
- Graduation: 0.01 or 0.02 mm.
- Clamping stem: with or without clamp nut.
- Conforms to factory standard.
- Many models available, like:
 - with reversed reading,
 - with rotating or non-rotating spindle,
 - with spindle lock,
 - with large thimble diameter, for easy reading.

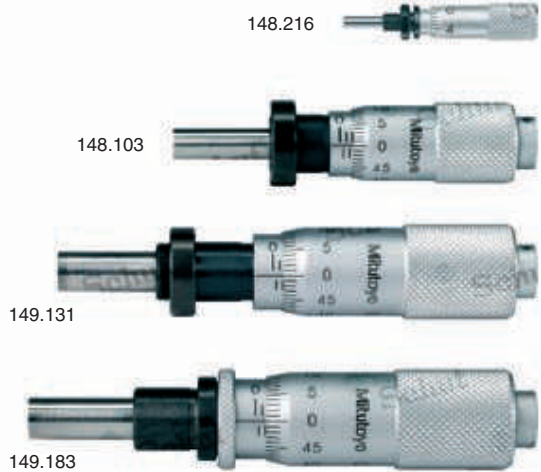
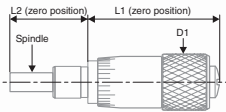

Item No.	Measuring range/mm	Graduation mm	Accuracy mm	Clamp nut	Dimensions/mm			Price EUR	
					spindle	D1	L1		
For general applications:									
148.104	0-13	0.01	±0.002	no	∅5	∅13	31.5	27	57.00
148.103	0-13	0.01	±0.002	yes	∅5	∅13	31.5	27	67.00
For general applications with spherical measuring face:									
148.801	0-13	0.01	±0.002	no	∅5	∅13	31.5	27	64.00
148.802	0-13	0.01	±0.002	yes	∅5	∅13	31.5	27	70.00
Ultra-small micrometer heads with spherical measuring face:									
148.215	0-5	0.02	±0.005	no	∅2	∅6	20.5	11.5	97.00
148.216	0-5	0.02	±0.005	yes	∅2	∅6	20.5	11.5	101.00
148.205	0-6.5	0.01	±0.005	no	∅3.5	∅9	21.7	15	65.00
148.207	0-6.5	0.01	±0.005	yes	∅3.5	∅9	21.7	15	67.00
With lapped tungsten carbide measuring face:									
149.132	0-15	0.01	±0.002	no	∅6.35	∅15	43.5	32	68.00
149.131	0-15	0.01	±0.002	yes	∅6.35	∅15	43.5	32	72.00
With lapped tungsten carbide spherical measuring face:									
149.801	0-15	0.01	±0.002	no	∅6.35	∅15	43.5	32	69.00
149.802	0-15	0.01	±0.002	yes	∅6.35	∅15	43.5	32	73.00
With lapped tungsten carbide measuring face, with spindle lock:									
149.183	0-15	0.01	±0.002	no	∅6.35	∅15	49	26.5	68.00
149.184	0-15	0.01	±0.002	yes	∅6.35	∅15	49	26.5	72.00
With lapped tungsten carbide measuring face, with ratchet:									
150.192	0-25	0.01	±0.002	no	∅6.35	∅18	67	42	57.00
150.191	0-25	0.01	±0.002	yes	∅6.35	∅18	67	42	67.00
With lapped tungsten carbide spherical measuring face, with ratchet:									
150.801	0-25	0.01	±0.002	no	∅6.35	∅18	67	42	68.00
150.802	0-25	0.01	±0.002	yes	∅6.35	∅18	67	42	74.00

Mitutoyo Digimatic micrometer heads IP65

These digital micrometer heads have an ergonomic design and a high protection degree against water jets (IP65).

- Measuring range: 0-25 mm.
- Resolution: 0.001 mm.
- ABS/INC switchable.
- Digimatic data output.
- Reset/preset.
- Hold function.
- Non-rotating spindle (only 350.261).
- Protection: IP65.
- Resistant to workshop conditions.
- Conforms to factory standard.
- Power supply: 1 battery type V357.



350.271



350.272

Data cables Digimatic, USB Input Tool Direct, U-WAVE available on request.

Item No.	Measuring range/mm	Accuracy/mm	Spindle ϕ /mm	Clamp nut	Price EUR
350.261	0-25	± 0.002	6.35	no	451.00
350.271	0-25	± 0.002	6.35	no	418.00
350.272	0-25	± 0.002	6.35	yes	428.00
Option:					
836.535	Spare battery				1.90

Mitutoyo Digimatic micrometer head

Digital micrometer head with non-rotating spindle for integration into machinery and measuring systems such as XY measuring tables of microscopes and projectors. The display and operating unit is rotatable over 330° and guarantees an ideal read-out in any position.

- Measuring range: 0-50 mm.
- Resolution: 0.001 mm.
- ABS/INC switchable.
- LCD display 330° rotatable.
- Digimatic data output.
- On/off switch.
- Reset/preset.
- Clamping stem without clamp nut.
- Non-rotating spindle.
- Reversible measuring direction.
- Lapped tungsten carbide measuring face: $\phi 8$ mm.
- Conforms to factory standard.
- Delivery in a case.
- Power supply: 1 battery type V357.



Data cables Digimatic, USB Input Tool Direct, U-WAVE available on request.

Item No.	Measuring range/mm	Accuracy mm	Spindle ϕ /mm	Price EUR
164.163	0-50	± 0.003	8	772.00
Option:				
836.535	Spare battery			1.90



Internal micrometers / Internal & external measuring instruments

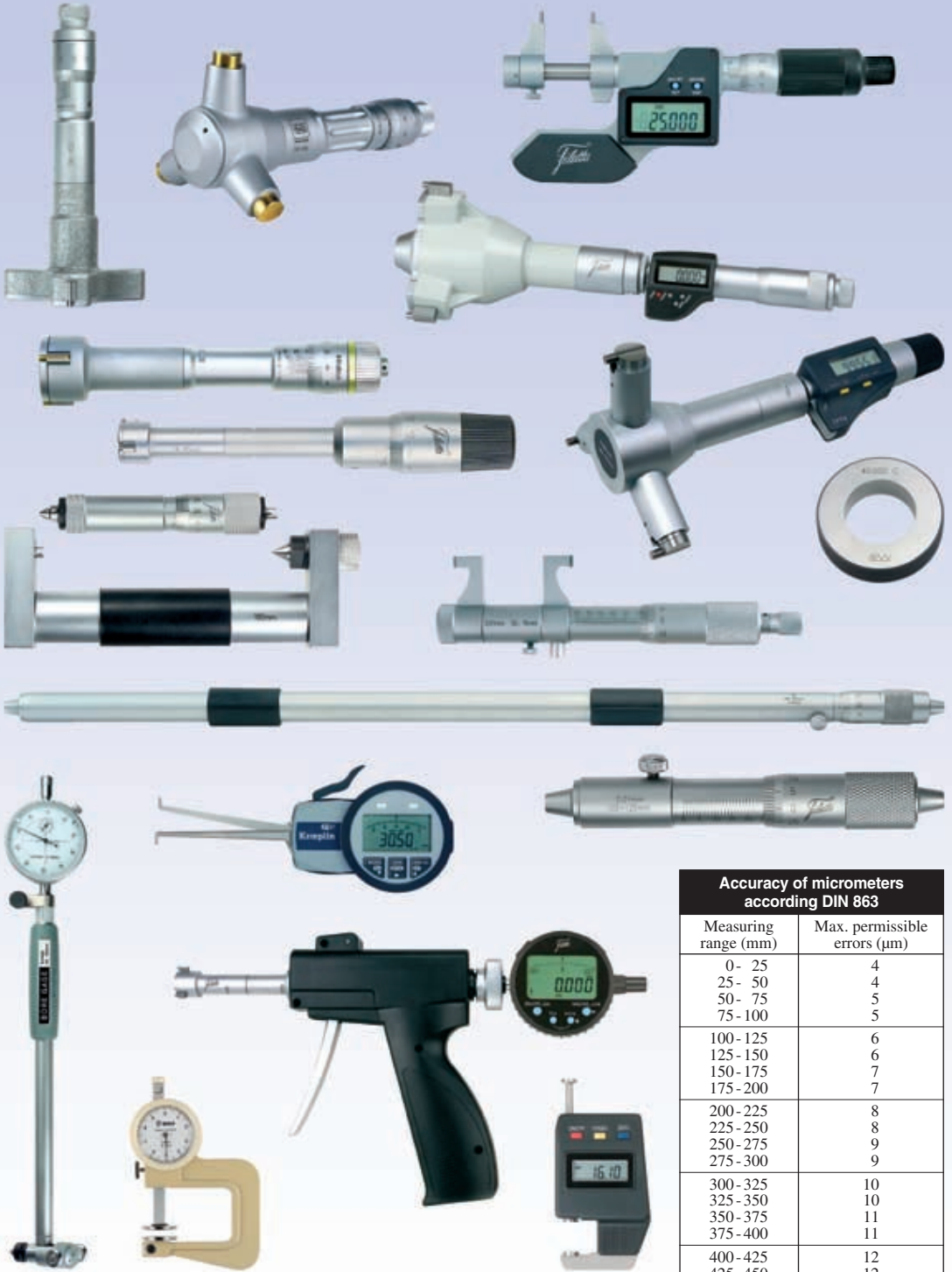

Accuracy of micrometers according DIN 863	
Measuring range (mm)	Max. permissible errors (µm)
0 - 25	4
25 - 50	4
50 - 75	5
75 - 100	5
100 - 125	6
125 - 150	6
150 - 175	7
175 - 200	7
200 - 225	8
225 - 250	8
250 - 275	9
275 - 300	9
300 - 325	10
325 - 350	10
350 - 375	11
375 - 400	11
400 - 425	12
425 - 450	12
450 - 475	13
475 - 500	13

Three-point internal micrometers

Three-point internal micrometers for quick and accurate measurement of internal dimensions, within a large measuring range.

- Measuring range: \varnothing 3.5 - 300 mm.
- Graduation: 0.001 mm (\varnothing 3.5 - 12 mm),
0.005 mm (\varnothing 12 - 300 mm).
- Tungsten carbide measuring faces.
- Delivery in a case.
- Sets are delivered incl. setting rings and extension (836.730 without extension).
- Setting rings are conform to factory standard.



Item No.	Measuring range/mm	Accuracy mm	Price EUR
836.700	\varnothing 3.5 - 4	± 0.005	142.00
836.701	\varnothing 4.0 - 4.5	± 0.005	142.00
836.702	\varnothing 4.5 - 5.5	± 0.005	142.00
836.703	\varnothing 5.5 - 6.5	± 0.005	142.00
836.704	\varnothing 6 - 8	± 0.005	142.00
836.705	\varnothing 8 - 10	± 0.005	142.00
836.706	\varnothing 10 - 12	± 0.005	142.00
836.707	\varnothing 12 - 16	± 0.005	142.00
836.708	\varnothing 16 - 20	± 0.005	142.00
836.709	\varnothing 20 - 25	± 0.005	142.00
836.710	\varnothing 25 - 30	± 0.005	142.00
836.711	\varnothing 30 - 35	± 0.005	142.00
836.712	\varnothing 35 - 40	± 0.005	142.00
836.713	\varnothing 40 - 50	± 0.006	166.00
836.714	\varnothing 50 - 60	± 0.006	166.00
836.715	\varnothing 60 - 70	± 0.006	166.00
836.716	\varnothing 70 - 80	± 0.006	166.00
836.717	\varnothing 80 - 90	± 0.006	166.00
836.718	\varnothing 90 - 100	± 0.006	166.00
836.719	\varnothing 100 - 125	± 0.008	285.00
836.720	\varnothing 125 - 150	± 0.008	285.00
836.721	\varnothing 150 - 175	± 0.008	285.00
836.722	\varnothing 175 - 200	± 0.008	285.00
836.723	\varnothing 200 - 225	± 0.012	356.00
836.724	\varnothing 225 - 250	± 0.012	356.00
836.725	\varnothing 250 - 275	± 0.012	356.00
836.726	\varnothing 275 - 300	± 0.012	356.00
Sets:			
836.730*	\varnothing 3.5 - 6.5	± 0.005	594.00
836.735	\varnothing 6 - 12	± 0.005	389.00
836.740	\varnothing 12 - 20	± 0.005	342.00
836.745	\varnothing 20 - 40	± 0.005	608.00
836.750	\varnothing 40 - 100	± 0.006	950.00

* Without extension.



836.718



Extensions

Item No.	Extension mm	For measuring range/mm	Price EUR
836.780	100	\varnothing 6 - 12	67.00
836.782	150	\varnothing 12 - 20	67.00
836.784	150	\varnothing 20 - 40	67.00
836.786	150	\varnothing 40 - 100	67.00

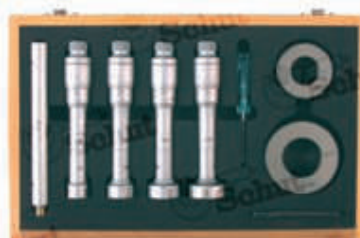

836.745

Setting rings

Measuring range/mm	Setting rings \varnothing /mm
\varnothing 3.5 - 6.5	4, 5.5
\varnothing 6 - 12	8, 10
\varnothing 12 - 20	16
\varnothing 20 - 40	25, 35
\varnothing 40 - 100	50, 70, 90

Three-point internal micrometers

Three-point internal micrometers, with factory measuring report, for accurately measuring bores.

- Measuring range: 0 - 300 mm.
- Self-centering.
- Tungsten carbide measuring faces (measuring range ϕ 6- 12 mm: hardened steel).
- Separate instruments within measuring range ϕ 6- 100 mm and the sets are delivered incl. setting ring(s) and extension.
- Setting rings are conform to factory standard.
- Delivery in a case, with an inspection report.

Analog

- Graduation: 0.001 mm (ϕ 6- 12 mm), 0.005 mm (ϕ 12 - 300 mm).

Digital

- Resolution: 0.001 mm.
- mm/inch conversion.
- ABS/INC switchable.
- On/off switch.
- Reset/preset.
- Power supply: 1 battery type V357.



Item No.	Price EUR	Item No.	Price EUR	Measuring range/mm	Accuracy mm	Length L/mm	A/mm
Analog:		Digital:					
909.807	231.00	909.828	369.00	ϕ 6- 8	± 0.004	30	1
909.808	231.00	909.829	369.00	ϕ 8- 10	± 0.004	30	1
909.809	231.00	909.830	369.00	ϕ 10- 12	± 0.004	30	1
909.810	160.00	909.831	358.00	ϕ 12- 16	± 0.004	48	0.4
909.811	160.00	909.832	358.00	ϕ 16- 20	± 0.004	48	0.4
909.812	226.00	909.833	373.00	ϕ 20- 25	± 0.004	50	0.4
909.813	210.00	909.834	373.00	ϕ 25- 30	± 0.004	50	0.4
909.814	248.00	909.835	417.00	ϕ 30- 40	± 0.004	50	0.4
909.815	288.00	909.836	417.00	ϕ 40- 50	± 0.005	55	0.5
909.816	304.00	909.837	443.00	ϕ 50- 63	± 0.005	55	0.5
909.817	326.00	909.838	470.00	ϕ 62- 75	± 0.005	55	0.5
909.818	341.00	909.839	488.00	ϕ 75- 88	± 0.005	55	0.5
909.819	358.00	909.840	511.00	ϕ 87- 100	± 0.005	55	0.5
909.820	395.00	909.841	521.00	ϕ 100- 125	± 0.008	130	20
909.821	425.00	909.842	599.00	ϕ 125- 150	± 0.008	130	20
909.822	568.00	909.843	677.00	ϕ 150- 175	± 0.008	130	20
909.823	582.00	909.844	716.00	ϕ 175- 200	± 0.008	130	20
909.824	754.00	909.845	890.00	ϕ 200- 225	± 0.008	130	20
909.825	823.00	909.846	970.00	ϕ 225- 250	± 0.008	130	20
909.826	947.00	909.847	1,108.00	ϕ 250- 275	± 0.008	130	20
909.827	1,131.00	909.848	1,316.00	ϕ 275- 300	± 0.008	130	20

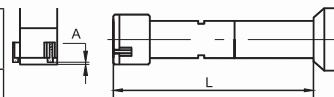

Options

Item No.	Description	Price EUR
836.535	Spare battery	1.90
For meas. range ϕ 100 - 300 mm:		
909.857	Extension with length 150 mm	79.00

Sets

Item No.	Price EUR	Item No.	Price EUR	Measuring range/mm	Setting rings ϕ /mm	Extension mm	Number of instruments
Analog:		Digital:					
909.849	646.00	909.853	1,008.00	ϕ 6- 12	8, 10	50	3
909.850	291.00	909.854	576.00	ϕ 12- 20	16	100	2
909.851	839.00	909.855	1,371.00	ϕ 20- 50	25, 40	150	4
909.852	1,106.00	909.856	1,590.00	ϕ 50- 100	62, 87	150	4



Three-point internal micrometers

Three-point internal micrometers for accurately measuring (blind) bores.

- Measuring range: \varnothing 6- 300 mm.
- Graduation: 0.001 mm (\varnothing 6- 12 mm),
0.005 mm (\varnothing 12- 300 mm).
- Self-centering.
- Tungsten carbide measuring faces.
- Interchangeable measuring bolts from measuring range \varnothing 100- 125 mm.
- Delivery in a case, incl. extension 150 mm (measuring range \varnothing 6- 12 mm: 100 mm).
- Separate instruments within measuring range \varnothing 6- 100 mm and the sets are delivered incl. setting ring(s).
- Setting rings are conform to factory standard.

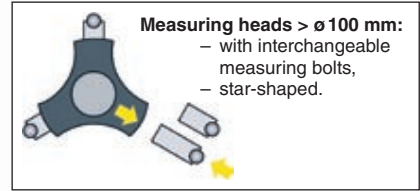

908.654

PRICE

Item No.	Measuring range/mm	Setting ring \varnothing /mm	Accuracy mm	Length L/mm	Length A/mm	Price EUR
908.650	\varnothing 6- 8	6	± 0.004	55	0.7	206.00
908.651	\varnothing 8- 10	8	± 0.004	55	0.7	206.00
908.652	\varnothing 10- 12	10	± 0.004	55	0.7	206.00
908.653	\varnothing 12- 16	16	± 0.004	80	0.7	139.00
908.654	\varnothing 16- 20	16	± 0.004	80	0.7	139.00
908.655	\varnothing 20- 25	25	± 0.004	90	0.7	195.00
908.656	\varnothing 25- 30	25	± 0.004	90	0.7	195.00
908.657	\varnothing 30- 40	40	± 0.004	97	0.7	215.00
908.658	\varnothing 40- 50	40	± 0.005	97	0.7	249.00
908.659	\varnothing 50- 63	62	± 0.005	114	0.7	263.00
908.660	\varnothing 62- 75	62	± 0.005	114	0.7	283.00
908.661	\varnothing 75- 88	87	± 0.005	114	0.7	295.00
908.662	\varnothing 87- 100	87	± 0.005	114	0.7	310.00
908.663	\varnothing 100- 125	-	± 0.005	150	0.7	342.00
908.664	\varnothing 125- 150	-	± 0.005	150	0.7	410.00
908.665	\varnothing 150- 175	-	± 0.005	150	0.7	491.00
908.666	\varnothing 175- 200	-	± 0.005	150	0.7	594.00
908.667	\varnothing 200- 225	-	± 0.007	150	0.7	709.00
908.668	\varnothing 225- 250	-	± 0.007	150	0.7	790.00
908.669	\varnothing 250- 275	-	± 0.007	150	0.7	926.00
908.670	\varnothing 275- 300	-	± 0.007	150	0.7	1,110.00

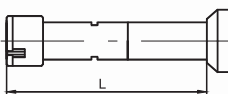

Item No.	Measuring range/mm	Setting rings \varnothing /mm	Extension mm	Number of instruments	Price EUR
908.671	\varnothing 6- 12	6, 8, 10	100	3	561.00
908.672	\varnothing 12- 20	16	150	2	252.00
908.673	\varnothing 20- 50	25, 40	150	4	727.00
908.674	\varnothing 50- 100	62, 87	150	4	958.00

Digital three-point internal micrometers

Digital three-point internal micrometers with a resolution of 0.001 mm for accurately measuring (blind) bores. These micrometers have several functions, and combined with the accurate read-out this results in a favourable price-performance ratio.



- Measuring range: \varnothing 6-300 mm.
- Resolution: 0.001 mm.
- mm/inch conversion.
- ABS/INC switchable.
- On/off switch.
- Automatic switch-off.
- Reset/preset.
- Self-centering.
- Tungsten carbide measuring faces.



- Interchangeable measuring bolts from measuring range \varnothing 100-125 mm.
- Protection: IP54.
- Delivery in a case, incl. extension 150 mm (measuring range \varnothing 6-12 mm: 100 mm).
- Separate instruments within measuring range \varnothing 6-100 mm and the sets are delivered incl. setting ring(s) (conforms to factory standard).
- Power supply: 1 battery type V357.

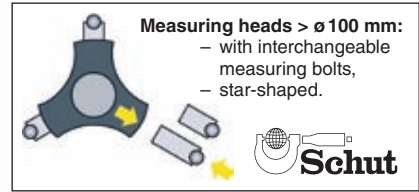

Item No.	Measuring range/mm	Setting ring \varnothing /mm	Accuracy mm	Length L/mm	Length A/mm	Price EUR
906.886	\varnothing 6- 8	6	± 0.004	62	0.7	319.00
906.887	\varnothing 8- 10	8	± 0.004	62	0.7	319.00
906.888	\varnothing 10- 12	10	± 0.004	62	0.7	319.00
906.889	\varnothing 12- 16	16	± 0.004	80	0.7	310.00
906.890	\varnothing 16- 20	16	± 0.004	80	0.7	310.00
906.891	\varnothing 20- 25	25	± 0.004	105	0.7	323.00
906.892	\varnothing 25- 30	25	± 0.004	105	0.7	323.00
906.893	\varnothing 30- 40	40	± 0.004	97	0.7	361.00
906.894	\varnothing 40- 50	40	± 0.005	110	0.7	361.00
906.895	\varnothing 50- 63	62	± 0.005	114	0.7	384.00
906.896	\varnothing 62- 75	62	± 0.005	127	0.7	407.00
906.897	\varnothing 75- 88	87	± 0.005	114	0.7	423.00
906.898	\varnothing 87- 100	87	± 0.005	114	0.7	442.00
906.899	\varnothing 100- 125	-	± 0.005	150	0.7	451.00
908.675	\varnothing 125- 150	-	± 0.005	150	0.7	519.00
908.676	\varnothing 150- 175	-	± 0.005	150	0.7	600.00
908.677	\varnothing 175- 200	-	± 0.005	150	0.7	702.00
908.678	\varnothing 200- 225	-	± 0.007	150	0.7	817.00
908.679	\varnothing 225- 250	-	± 0.007	150	0.7	891.00
908.680	\varnothing 250- 275	-	± 0.007	150	0.7	1,130.00
908.681	\varnothing 275- 300	-	± 0.007	150	0.7	1,334.00

Option:

836.535 Spare battery

1.90

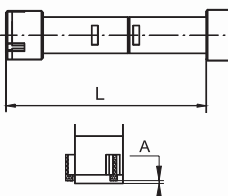

Item No.	Measuring range/mm	Setting rings \varnothing /mm	Extension mm	Number of instruments	Price EUR
906.900	\varnothing 6- 12	6, 8, 10	100	3	873.00
906.901	\varnothing 12- 20	16	150	2	561.00
906.902	\varnothing 20- 50	25, 40	150	4	1,187.00
906.903	\varnothing 50- 100	62, 87	150	4	1,377.00

Digital three-point internal micrometers

Digital three-point internal micrometers with a large measuring range. With optional extensions also for measuring in deep (blind) bores.

- Measuring range: \varnothing 50 - 300 mm.
- Max. measuring depth: 1100 mm.
- Resolution: 0.001 mm.
- mm/inch conversion.
- ABS/INC switchable.
- On/off switch.
- Automatic switch-off.
- Reset/preset.
- Self-centering.
- Tungsten carbide measuring faces.
- Protection: IP54.
- Delivery in a case, incl. extension 150 mm.
- Separate instruments within measuring range \varnothing 50 - 100 mm and the sets are delivered incl. setting ring(s).
- Setting rings are conform to factory standard.
- Power supply: 1 battery type V357.



NEW

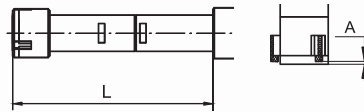

Extensions

Item No.	Extension mm	Price EUR
906.227	150	27.00
906.228	500	163.00
906.229	1000	490.00



Item No.	Measuring range/mm	Setting ring \varnothing /mm	Accuracy mm	Length L/mm	Length A/mm	Price EUR
906.904	\varnothing 50 - 70	50	± 0.004	107	0.5	344.00
906.905	\varnothing 70 - 100	70	± 0.004	107	0.5	461.00
906.906	\varnothing 100 - 150	-	± 0.005	107	0.5	761.00
906.907	\varnothing 150 - 250	-	± 0.007	107	0.5	1,559.00
906.908	\varnothing 200 - 300	-	± 0.007	107	0.5	2,190.00

Item No.	Measuring range/mm	Setting ring \varnothing /mm	Number of instruments	Price EUR
906.909	\varnothing 50 - 100	70	2	806.00
906.910	\varnothing 100 - 250	150	2	2,320.00

Option

Item No.	Description	Price EUR
836.535	Spare battery	1.90

Digital three-point internal micrometers up to 1000 mm

Digital three-point internal micrometers with a large measuring range. With optional extensions also for measuring in deep bores.

- Measuring range: \varnothing 200 - 1000 mm.
- Resolution: 0.001 mm.
- mm/inch conversion.
- ABS/INC switchable.
- On/off switch.
- Automatic switch-off.
- Reset/preset.
- Self-centering.
- Tungsten carbide measuring faces.
- Protection: IP54.
- Delivered incl. setting ring.
- Power supply: 1 battery type V357.



907.787

With interchangeable measuring bolts

The measuring range is extra large because of the interchangeable measuring bolts. The high accuracy of the measuring bolts enables exchanging without recalibrating the read-out.

- Max. measuring depth:
907.787: 750 mm,
907.788: 1750 mm.
- Accuracy:
 $\pm(1+0.02L) \mu\text{m}$ (L in mm).
- Delivery in a case, incl. extensions and setting ring.



Item No.	Measuring range/mm	Setting ring \varnothing /mm	Length L/mm	Length A/mm	Extensions mm	Price EUR
907.787	\varnothing 200 - 500	200	105	0.5	150, 500	5,430.00
907.788	\varnothing 200 - 1000	200	105	0.5	150, 500, 1000	6,390.00

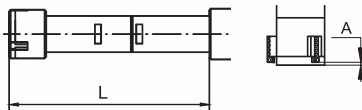

Option

Item No.	Description	Price EUR
836.535	Spare battery	1.90

NEW

Extensions

Item No.	Extension mm	Price EUR
906.227	150	27.00
906.228	500	163.00
906.229	1000	490.00

TESA Imicro three-point internal micrometers

The Imicro measuring system has a unique combination of a threaded cone and three measuring arms. This makes the TESA Imicro a highly accurate measuring instrument.

- Measuring range: \varnothing 3.5 - 300 mm.
- Graduation: 0.001 mm (\varnothing 3.5 - 12 mm),
0.005 mm (\varnothing 11 - 100 mm),
0.01 mm (\varnothing 100 - 300 mm).
- Measuring faces:
 \varnothing 3.5 - 12 mm: hardened steel,
 \varnothing 11 - 100 mm: titanium nitride (TiN),
 \varnothing 100 - 300 mm: tungsten carbide.
- DIN 863 T4.
- Delivery in a case with an inspection report and a declaration of conformity.



779.542



Item No.	Measuring range mm	Accuracy mm	Repeat-ability mm	Length/mm			Price EUR
				A	B	C	
779.571	\varnothing 3.5 - 4	± 0.004	0.004	2	1.5	20	683.00
779.572	\varnothing 4 - 4.5	± 0.004	0.004	2	1.5	20	683.00
779.573	\varnothing 4.5 - 5.5	± 0.004	0.004	2	1.5	25	686.00
779.574	\varnothing 5.5 - 6.5	± 0.004	0.004	2	1.5	25	686.00
779.481	\varnothing 6 - 8	± 0.004	0.004	2.5	2.5	52	385.00
779.482	\varnothing 8 - 10	± 0.004	0.004	2.5	2.5	52	388.00
779.483	\varnothing 10 - 12	± 0.004	0.004	2.5	2.5	52	389.00
779.497	\varnothing 11 - 14	± 0.004	0.004	3.5	4	77	441.00
779.498	\varnothing 14 - 17	± 0.004	0.004	3.5	4	77	445.00
779.499	\varnothing 17 - 20	± 0.004	0.004	3.5	4	77	448.00
779.515	\varnothing 20 - 25	± 0.004	0.004	7	7	78	484.00
779.516	\varnothing 25 - 30	± 0.004	0.004	7	7	78	493.00
779.517	\varnothing 30 - 35	± 0.004	0.004	7	7	78	499.00
779.518	\varnothing 35 - 40	± 0.004	0.004	7	7	78	503.00
779.539	\varnothing 40 - 50	± 0.005	0.005	11	12	84	596.00
779.540	\varnothing 50 - 60	± 0.005	0.005	11	12	84	607.00
779.541	\varnothing 60 - 70	± 0.005	0.005	11	12	84	618.00
779.542	\varnothing 70 - 80	± 0.005	0.005	11	12	84	626.00
779.543	\varnothing 80 - 90	± 0.005	0.005	11	12	84	638.00
779.544	\varnothing 90 - 100	± 0.005	0.005	11	12	84	661.00
779.553	\varnothing 100 - 125	± 0.006	0.006	26	18	81	1,117.00
779.554	\varnothing 125 - 150	± 0.006	0.006	26	18	81	1,122.00
779.555	\varnothing 150 - 175	± 0.007	0.007	26	18	81	1,127.00
779.556	\varnothing 175 - 200	± 0.007	0.007	26	18	81	1,161.00
779.562	\varnothing 200 - 225	± 0.008	0.008	26	18	81	1,551.00
779.563	\varnothing 225 - 250	± 0.008	0.008	26	18	81	1,569.00
779.564	\varnothing 250 - 275	± 0.008	0.008	26	18	81	1,632.00
779.565	\varnothing 275 - 300	± 0.008	0.008	26	18	81	1,683.00

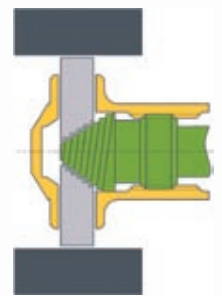
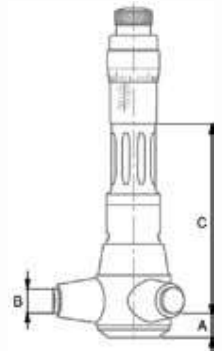

The threaded cone prevents spindle errors (Abbe-comparator principle).

TESA Imicro three-point internal micrometers in sets

- Measuring range: \varnothing 3.5 - 200 mm.
- Graduation: 0.001 mm (\varnothing 3.5 - 12 mm),
0.005 mm (\varnothing 11 - 100 mm),
0.01 mm (\varnothing 100 - 200 mm).



779.538

- Measuring faces:
 \varnothing 3.5 - 12 mm: hardened steel,
 \varnothing 11 - 100 mm: titanium nitride (TiN),
 \varnothing 100 - 200 mm: tungsten carbide.
- Delivery incl. setting rings, extension, screw driver and adjustment tool.

Item No.	Measuring range/mm	Extension mm	Price EUR
779.570	\varnothing 3.5 - 6.5	-	2,855.00
779.480	\varnothing 6 - 12	100	1,464.00
779.496	\varnothing 11 - 20	150	1,690.00
779.514	\varnothing 20 - 40	150	2,420.00
779.538	\varnothing 40 - 100	150	5,055.00
779.552	\varnothing 100 - 200	150	6,409.00

Centering device



779.664



Item No.	For meas. range/mm	Price EUR
779.664	\varnothing 40 - 100	2,017.00
779.681	\varnothing 100 - 200	2,542.00

TESA Imicro extensions

TESA Imicro extensions for measuring in deep bores.



Imicro + extension + centering device

Item No.	Extension mm	For meas. range/mm	Price EUR
779.609	100	\varnothing 6 - 12	88.00
779.623	150	\varnothing 11 - 20	115.00
779.624	500	\varnothing 11 - 20	689.00
779.625	150	\varnothing 20 - 40	121.00
779.626	500	\varnothing 20 - 40	734.00
779.627	1000	\varnothing 20 - 40	883.00

Item No.	Extension mm	For meas. range/mm	Price EUR
779.628	150	\varnothing 40 - 100	142.00
779.629	500	\varnothing 40 - 100	979.00
779.630	1000	\varnothing 40 - 100	1,155.00
779.631	150	\varnothing 100 - 300	173.00
779.632	500	\varnothing 100 - 300	945.00
779.633	1000	\varnothing 100 - 300	1,557.00

Etalon Intalometer three-point internal micrometers

Etalon three-point internal micrometers are specially suited for fast and accurate measurements of the diameter of blind bores.

- Measuring range: ϕ 5 - 100 mm.
- Vernier: 0.002 mm.
- Angle of the measuring arms:
 - ϕ 5 - 10 mm: $2 \times 180^\circ$,
 - ϕ 10 - 20 mm: $3 \times 120^\circ$,
 - ϕ 20 - 100 mm: $90^\circ - 135^\circ - 135^\circ$.
- From ϕ 20 mm onwards, form errors can be detected because of the irregular location of the measuring arms.
- Measuring range 5 - 10 mm with two-point contact.
- Hardened steel measuring faces.
- DIN 863 T4 (from 10 to 100 mm).
- Delivery in a case with an inspection report and a declaration of conformity.
- Measuring ranges of ϕ 100 - 300 mm available on request. These instruments have interchangeable measuring bolts.

- Also available in sets, on request. Sets up to ϕ 100 mm consist of all complete instruments, extension and setting rings.

Extensions

Item No.	Extension mm	For measuring range/mm	Price EUR
836.224	100	ϕ 5 - 10	168.00
836.225	150	ϕ 10 - 20	202.00
836.226	150	ϕ 20 - 40	206.00
836.227	150	ϕ 40 - 100	250.00

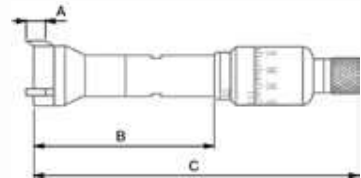

836.215

Item No.	Measuring range/mm	Accuracy mm	Length/mm			Price EUR
			A	B	C	
836.206	ϕ 5 - 6	± 0.003	3	≥ 32	≤ 109	1,010.00
836.207	ϕ 6 - 7	± 0.003	3	≥ 33	≤ 111	1,010.00
836.208	ϕ 7 - 8.5	± 0.003	4	≥ 60	≤ 130	1,010.00
836.209	ϕ 8.5 - 10	± 0.003	4	≥ 72	≤ 133	1,010.00
836.210	ϕ 10 - 12.5	± 0.003	3	≥ 60	≤ 118	952.00
836.211	ϕ 12.5 - 15	± 0.003	3	≥ 63	≤ 120	952.00
836.212	ϕ 15 - 17.5	± 0.003	3	≥ 65	≤ 122	952.00
836.213	ϕ 17.5 - 20	± 0.003	3	≥ 68	≤ 125	952.00
836.214	ϕ 20 - 25	± 0.003	7	≥ 75	≤ 132	1,060.00
836.215	ϕ 25 - 30	± 0.003	7	≥ 80	≤ 138	1,060.00
836.216	ϕ 30 - 35	± 0.003	7	≥ 90	≤ 142	1,091.00
836.217	ϕ 35 - 40	± 0.003	7	≥ 90	≤ 148	1,124.00
836.218	ϕ 40 - 45	± 0.004	10.5	≥ 110	≤ 167	1,264.00
836.219	ϕ 45 - 50	± 0.004	10.5	≥ 113	≤ 170	1,264.00
836.220	ϕ 50 - 60	± 0.004	15	≥ 123	≤ 187	1,394.00
836.221	ϕ 60 - 70	± 0.004	15	≥ 130	≤ 193	1,394.00
836.222	ϕ 70 - 85	± 0.004	15	≥ 145	≤ 213	1,523.00
836.223	ϕ 85 - 100	± 0.004	15	≥ 155	≤ 224	1,523.00



TESA Tri-o-Bor three-point internal micrometers

TESA three-point internal micrometers for rapid and accurate measuring of internal dimensions, suited for through holes, blind bores and short centering shoulders.

- Measuring range: \varnothing 15 - 120 mm.
- Graduation: 0.002 mm.
- Measuring heads with tungsten carbide measuring faces.
- DIN 863 T4.
- Delivery with an inspection report and a declaration of conformity.
- Interchangeable measuring bolts from measuring range \varnothing 60 mm.
- On request also available in complete sets or partial sets with separate measuring heads.



779.711

Complete instruments

Item No.	Measuring range/mm	Accuracy mm	Length/mm			Price EUR
			A	B	C	
779.700	\varnothing 15 - 20	± 0.004	6	≥ 66	≤ 132	1,078.00
779.701	\varnothing 20 - 25	± 0.004	6	≥ 66	≤ 132	1,088.00
779.702	\varnothing 25 - 30	± 0.004	6	≥ 66	≤ 132	1,112.00
779.709	\varnothing 30 - 40	± 0.004	10	≥ 70	≤ 138	1,256.00
779.710	\varnothing 40 - 50	± 0.004	10	≥ 70	≤ 138	1,291.00
779.711	\varnothing 50 - 60	± 0.005	10	≥ 70	≤ 138	1,321.00
779.717	\varnothing 60 - 70	± 0.005	18	≥ 78	≤ 147	1,415.00
779.718	\varnothing 70 - 80	± 0.005	18	≥ 78	≤ 147	1,423.00
779.719	\varnothing 80 - 90	± 0.005	18	≥ 78	≤ 147	1,431.00
779.727	\varnothing 90 - 100	± 0.005	18	≥ 78	≤ 147	1,532.00
779.728	\varnothing 100 - 110	± 0.006	18	≥ 78	≤ 147	1,539.00
779.729	\varnothing 110 - 120	± 0.006	18	≥ 78	≤ 147	1,547.00



Measuring heads $> \varnothing$ 60 mm with interchangeable measuring bolts (on request also separately available).

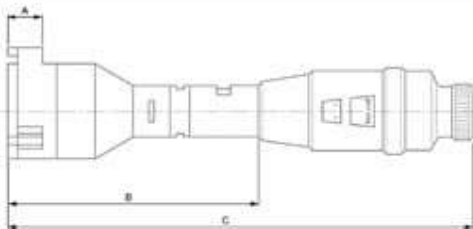

Item No.	Measuring range/mm	Price EUR
----------	--------------------	-----------

Measuring element without measuring head:

779.706	\varnothing 15 - 60	537.00
779.721	\varnothing 60 - 120	537.00

Measuring heads*:

779.703	\varnothing 15 - 20	544.00
779.704	\varnothing 20 - 25	561.00
779.705	\varnothing 25 - 30	583.00
779.712	\varnothing 30 - 40	728.00
779.713	\varnothing 40 - 50	763.00
779.714	\varnothing 50 - 60	794.00

* Larger measuring ranges available on request.

Extension

Item No.	Extension/mm	Price EUR
779.771	150	178.00

TESA Imicro digital *capa* μ three-point internal micrometers

These TESA Imicro internal micrometers combine the unique measuring cone, that prevents spindle errors, with the patented *capa* μ measuring system.

- Measuring range: \varnothing 3.5 - 300 mm.
- Resolution: 0.001 mm.
- mm/inch conversion.
- ABS/INC switchable.
- Opto-RS232C data output, bidirectional.
- Automatic switch-off.
- Reset/preset.
- Measuring faces:
 - \varnothing 3.5 - 12 mm: hardened steel,
 - \varnothing 11 - 100 mm: titanium nitride (TiN),
 - \varnothing 100 - 300 mm: tungsten carbide.
- Protection: IP54.
(When using data output: IP40.)
- DIN 863 T4.
- Delivery in a case with an inspection report and a declaration of conformity.
- Power supply: 1 battery type CR2032.
- Electronic measuring elements, several sets, individual measuring heads and extensions available.



782.542

782.562

Sets with individual measuring heads

Consist of 1 electronic measuring element with interchangeable measuring heads, setting rings and an extension (no extension for the 782.564).

Item No.	Measuring range/mm	Price EUR
782.564	\varnothing 3.5 - 6.5	4,270.00
782.565	\varnothing 6 - 12	2,178.00
782.566	\varnothing 11 - 20	2,335.00
782.567	\varnothing 20 - 40	3,068.00
782.568	\varnothing 40 - 100	5,637.00
782.569	\varnothing 100 - 200	7,745.00

Extensions

Item No.	Extension mm	For measuring range/mm	Price EUR
779.609	100	\varnothing 6 - 12	88.00
779.623	150	\varnothing 11 - 20	115.00
779.625	150	\varnothing 20 - 40	121.00
779.628	150	\varnothing 40 - 100	142.00
779.631	150	\varnothing 100 - 200	173.00

Complete sets

Consist of all the instruments of the measuring range, setting rings and an extension (no extension for the 782.558).

Item No.	Measuring range/mm	Price EUR
782.558	\varnothing 3.5 - 6.5	5,140.00
782.559	\varnothing 6 - 12	3,340.00
782.560	\varnothing 11 - 20	3,460.00
782.561	\varnothing 20 - 40	4,712.00
782.562	\varnothing 40 - 100	8,456.00
782.563	\varnothing 100 - 200	9,175.00

Option

Item No.	Description	Price EUR
495.157	Spare battery	0.50



TESA Imicro digital three-point internal micrometers (continued)



The threaded cone prevents spindle errors (Abbe-comparator principle).

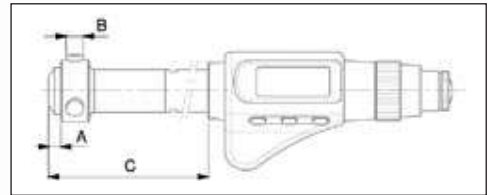
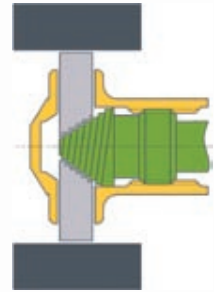

Complete instruments

Item No.	Measuring range/mm	Accuracy mm	Repeatability mm	Length/mm			Price EUR
				A	B	C	
782.530	∅ 3.5 - 4	±0.004	0.004	2	1.5	20	1,292.00
782.531	∅ 4 - 4.5	±0.004	0.004	2	1.5	20	1,292.00
782.532	∅ 4.5 - 5.5	±0.004	0.004	2	1.5	25	1,292.00
782.533	∅ 5.5 - 6.5	±0.004	0.004	2	1.5	25	1,292.00
782.534	∅ 6 - 8	±0.004	0.004	2.5	2.5	79	1,044.00
782.535	∅ 8 - 10	±0.004	0.004	2.5	2.5	79	1,052.00
782.536	∅ 10 - 12	±0.004	0.004	2.5	2.5	79	1,062.00
782.537	∅ 11 - 14	±0.004	0.004	3.5	4	93	1,066.00
782.538	∅ 14 - 17	±0.004	0.004	3.5	4	93	1,072.00
782.539	∅ 17 - 20	±0.004	0.004	3.5	4	93	1,078.00
782.540	∅ 20 - 25	±0.004	0.004	7	7	91	1,084.00
782.541	∅ 25 - 30	±0.004	0.004	7	7	91	1,096.00
782.542	∅ 30 - 35	±0.004	0.004	7	7	91	1,112.00
782.543	∅ 35 - 40	±0.004	0.004	7	7	91	1,124.00
782.544	∅ 40 - 50	±0.005	0.005	11	12	104	1,164.00
782.545	∅ 50 - 60	±0.005	0.005	11	12	104	1,183.00
782.546	∅ 60 - 70	±0.005	0.005	11	12	104	1,217.00
782.547	∅ 70 - 80	±0.005	0.005	11	12	104	1,241.00
782.548	∅ 80 - 90	±0.005	0.005	11	12	104	1,267.00
782.549	∅ 90 - 100	±0.005	0.005	11	12	104	1,292.00
782.550	∅ 100 - 125	±0.006	0.006	26	18	100	1,739.00
782.551	∅ 125 - 150	±0.006	0.006	26	18	100	1,757.00
782.552	∅ 150 - 175	±0.007	0.007	26	18	100	1,978.00
782.553	∅ 175 - 200	±0.007	0.007	26	18	100	1,996.00
782.554	∅ 200 - 225	±0.008	0.008	26	18	100	2,104.00
782.555	∅ 225 - 250	±0.008	0.008	26	18	100	2,129.00
782.556	∅ 250 - 275	±0.008	0.008	26	18	100	2,151.00
782.557	∅ 275 - 300	±0.008	0.008	26	18	100	2,132.00

Roch Alesometer three-point internal micrometers

For measuring internal dimensions, such as through and blind bores, and short centering shoulders.

- Measuring range: \varnothing 6 - 100 mm.
- Vernier: 0.001 mm.
- Measuring inserts:
 - \varnothing 6- 10 mm: hardened steel,
 - \varnothing 10- 100 mm: tungsten carbide tipped.
- Several sets and extensions available.
- Delivery in a case with a declaration of conformity.
- Larger measuring ranges available on request.



Model like
782.679 - 782.688



Model like
782.689 - 782.693



782.705

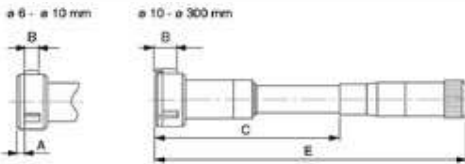

Complete instruments

Item No.	Measuring range/mm	Accuracy mm	Length/mm				Price EUR
			A	B	C	E	
782.679*	\varnothing 6 - 8	± 0.004	1.2	3	54.5	107	528.00
782.680*	\varnothing 8 - 10	± 0.004	1.2	3	54.5	107	533.00
782.681	\varnothing 10 - 12.5	± 0.004	-	6.5	64.5	117	555.00
782.682	\varnothing 12.5 - 15	± 0.004	-	6.5	64.5	117	562.00
782.683	\varnothing 15 - 17.5	± 0.004	-	6.8	64.5	117	561.00
782.684	\varnothing 17.5 - 20	± 0.004	-	6.8	64.5	117	570.00
782.685	\varnothing 20 - 25	± 0.004	-	8.5	70	122.5	578.00
782.686	\varnothing 25 - 30	± 0.004	-	8.5	70	122.5	586.00
782.687	\varnothing 30 - 35	± 0.004	-	8.5	70	122.5	593.00
782.688	\varnothing 35 - 40	± 0.004	-	8.5	70	122.5	627.00
782.689	\varnothing 40 - 50	± 0.004	-	14.5	108.7	188.7	669.00
782.690	\varnothing 50 - 60	± 0.005	-	14.5	108.7	188.7	697.00
782.691	\varnothing 60 - 70	± 0.005	-	14.5	126.7	188.7	775.00
782.692	\varnothing 70 - 85	± 0.005	-	14.5	126.7	206.7	834.00
782.693	\varnothing 85 - 100	± 0.005	-	14.5	126.7	206.7	867.00

Sets

Item No.	Measuring range/mm	Price EUR
782.702*	\varnothing 6 - 10	1,204.00
782.703	\varnothing 10 - 20	2,448.00
782.704	\varnothing 20 - 40	2,726.00
782.705	\varnothing 40 - 100	4,533.00

* Not suitable for measuring blind bores of less than 1.2 mm depth.

Extensions

Item No.	Extension mm	For measuring range/mm	Price EUR
782.672	100	\varnothing 6 - 10	137.00
782.673	100	\varnothing 10 - 20	151.00
782.674	150	\varnothing 20 - 40	305.00
782.675	150	\varnothing 40 - 100	305.00
782.676	200	\varnothing 100 - 300	355.00

TESA Alesometer digital *capa* μ three-point internal micrometers

The TESA Alesometer is a digital three-point internal micrometer with the patented *capa* μ measuring system, especially suitable for measuring internal dimensions, such as through and blind bores and short centering shoulders.

- Measuring range: ϕ 6-200 mm.
- Resolution: 0.001 mm.
- mm/inch conversion.
- Opto-RS232C data output, bidirectional.
- Automatic switch-off.
- Reset/preset.
- Hold function.
- Measuring inserts:
 - ϕ 6- 10 mm: hardened steel,
 - ϕ 10-200 mm: tungsten carbide tipped.
- Several sets and parts available.
- Protection: IP54.
(When using data output: IP40.)
- DIN 863 T4.
- Delivery in a case with an inspection report and a declaration of conformity.
- Power supply: 1 battery type CR2032.

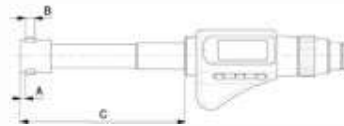

Complete instruments

Item No.	Measuring range/mm	Accuracy mm	Repeatability mm	Length/mm			Price EUR
				A ²	B	C	
782.625 ¹	ϕ 6 - 8	± 0.004	0.004	1.2	3	55	1,060.00
782.626 ¹	ϕ 8 - 10	± 0.004	0.004	1.2	3	55	1,060.00
782.627	ϕ 10 - 12.5	± 0.004	0.004	–	6.5	65	1,109.00
782.628	ϕ 12.5- 15	± 0.004	0.004	–	6.5	65	1,109.00
782.629	ϕ 15 - 17.5	± 0.004	0.004	–	6.8	65	1,109.00
782.630	ϕ 17.5- 20	± 0.004	0.004	–	6.8	95	1,109.00
782.631	ϕ 20 - 25	± 0.004	0.004	–	8.5	100	1,176.00
782.632	ϕ 25 - 30	± 0.004	0.004	–	8.5	100	1,176.00
782.633	ϕ 30 - 35	± 0.004	0.004	–	8.5	100	1,176.00
782.634	ϕ 35 - 40	± 0.004	0.004	–	8.5	100	1,176.00
782.635	ϕ 40 - 50	± 0.005	0.005	–	14.5	140	1,315.00
782.636	ϕ 50 - 60	± 0.005	0.005	–	14.5	140	1,315.00
782.637	ϕ 60 - 70	± 0.005	0.005	–	14.5	140	1,315.00
782.638	ϕ 70 - 85	± 0.005	0.005	–	14.5	140	1,396.00
782.639	ϕ 85 - 100	± 0.005	0.005	–	14.5	140	1,396.00
782.640	ϕ 100 - 125	± 0.006	0.006	–	30	175	1,828.00
782.641	ϕ 125 - 150	± 0.006	0.006	–	30	175	1,934.00
782.642	ϕ 150 - 175	± 0.007	0.007	–	30	175	2,049.00
782.643	ϕ 175 - 200	± 0.007	0.007	–	30	175	2,187.00
Option:							
495.157	Spare battery						0.50

¹ The instruments in measuring range ϕ 6- 10 mm are not suitable for measuring blind bores of < 1.2 mm depth.

² Not applicable to the models from ϕ 10 mm.

TESA Alesometer digital three-point internal micrometers (continued)

The sets consist of 1 electronic measuring element, interchangeable measuring heads, setting rings and a connector in a case.



782.651

Item No.	Measuring range/mm	Price EUR
Sets:		
782.648*	ø 6 - 10	1,457.00
782.649	ø 10 - 20	2,437.00
782.650	ø 20 - 40	2,592.00
782.651	ø 40 - 100	4,509.00
Case for partial sets:		
782.677	ø 6 - 40	85.00
Electronic measuring element:		
782.671	All measuring ranges	506.00

Extensions

Item No.	Extension mm	For measuring range/mm	Price EUR
782.672	100	ø 6 - 10	137.00
782.673	100	ø 10 - 20	151.00
782.674	150	ø 20 - 40	305.00
782.675	150	ø 40 - 100	305.00
782.676	200	ø 100 - 300	355.00

Item No.	Measuring range/mm	Price EUR
Measuring heads:		
782.652*	ø 6 - 8	414.00
782.653*	ø 8 - 10	419.00
782.654	ø 10 - 12.5	428.00
782.655	ø 12.5 - 15	432.00
782.656	ø 15 - 17.5	434.00
782.657	ø 17.5 - 20	440.00
782.658	ø 20 - 25	457.00
782.659	ø 25 - 30	462.00
782.660	ø 30 - 35	469.00
782.661	ø 35 - 40	496.00
782.662	ø 40 - 50	614.00
782.663	ø 50 - 60	617.00
782.664	ø 60 - 70	629.00
782.665	ø 70 - 85	771.00
782.666	ø 85 - 100	802.00
Connectors:		
782.667	ø 6 - 10	117.00
782.668	ø 10 - 20	119.00
782.669	ø 20 - 40	123.00
782.670	ø 40 - 100	131.00

* The instruments in measuring range ø 6 - 10 mm are not suitable for measuring blind bores of < 1.2 mm depth.

Mitutoyo Holtest three-point internal micrometers

Three-point internal micrometers for quick and accurate measurement of internal dimensions, within a large measuring range. These instruments have an improved ratchet mechanism and the application of high-quality materials ensures a long life span.

- Measuring range: \varnothing 6-300 mm.
- Analog: graduation 0.001 mm (\varnothing 6- 12 mm),
0.005 mm (\varnothing 12-300 mm),
digital: resolution 0.001 mm.
- Measuring faces:
 \varnothing 6- 12 mm: tungsten carbide, with titanium nitride (TiN) coating,
 \varnothing 12-300 mm: hardened steel, with titanium nitride (TiN) coating.
- Tungsten carbide cone and contact point of the spindle.
- No-glare chrome finished thimble.
- DIN 863 T4.
- Delivery in a case with a manufacturer's certificate.
- Sets are delivered incl. setting rings and extension.

Digital

- Digimatic data output.
- Automatic switch-off.
- Reset/preset.
- Hold function.
- Protection: IP65.
- Power supply: 1 battery type V357.
- The sets of the digital models consist of one instrument with interchangeable measuring heads.



Measuring range/mm	Accuracy mm	Item No.	Price EUR	Item No.	Price EUR
		Analog:		Digital:	
\varnothing 6- 8	± 0.002	368.161	330.00	468.161	921.00
\varnothing 8- 10	± 0.002	368.162	330.00	468.162	941.00
\varnothing 10- 12	± 0.002	368.163	330.00	468.163	957.00
\varnothing 12- 16	± 0.002	368.164	391.00	468.164	978.00
\varnothing 16- 20	± 0.002	368.165	401.00	468.165	988.00
\varnothing 20- 25	± 0.003	368.166	411.00	468.166	1,072.00
\varnothing 25- 30	± 0.003	368.167	421.00	468.167	1,072.00
\varnothing 30- 40	± 0.003	368.168	431.00	468.168	1,103.00
\varnothing 40- 50	± 0.003	368.169	443.00	468.169	1,124.00
\varnothing 50- 63	± 0.003	368.170	499.00	468.170	1,176.00
\varnothing 62- 75	± 0.003	368.171	520.00	468.171	1,186.00
\varnothing 75- 88	± 0.003	368.172	530.00	468.172	1,196.00
\varnothing 87- 100	± 0.003	368.173	541.00	468.173	1,243.00
\varnothing 100- 125	± 0.005	368.174	810.00	468.174	1,592.00
\varnothing 125- 150	± 0.005	368.175	863.00	468.175	1,706.00
\varnothing 150- 175	± 0.005	368.176	905.00	468.176	1,873.00
\varnothing 175- 200	± 0.005	368.177	927.00	468.177	1,977.00
\varnothing 200- 225	± 0.005	368.178	1,002.00	468.178	2,091.00
\varnothing 225- 250	± 0.005	368.179	1,029.00	468.179	2,153.00
\varnothing 250- 275	± 0.005	368.180	1,072.00	468.180	2,216.00
\varnothing 275- 300	± 0.005	368.181	1,181.00	468.181	2,326.00

368.168

468.168

Extensions

Item No.	Extension mm	For measuring range/mm	Price EUR
952.322	100	\varnothing 6- 12	95.00
952.621	150	\varnothing 12- 20	95.00
952.622	150	\varnothing 20- 50	105.00
952.623	150	\varnothing 50- 300	183.00

Option

Item No.	Description	Price EUR
836.535	Spare battery	1.90

Sets

Measuring range/mm	Extension mm	Item No.	Price EUR	Item No.	Price EUR
		Analog:		Digital:	
\varnothing 6- 12	100	368.911	879.00	468.971	1,714.00
\varnothing 12- 20	150	368.912	760.00	468.972	1,499.00
\varnothing 20- 50	150	368.913	1,743.00	468.973	2,487.00
\varnothing 50- 100	150	368.914	2,049.00	468.974	3,558.00
\varnothing 100- 200	150	368.915	4,177.00	468.975	5,144.00



Data cables
Digimatic,
USB Input Tool
Direct, U-WAVE
available on
request.

368.914

Mitutoyo Borematic digital three-point internal micrometers

Three-point internal micrometers with the absolute measuring system and a large 6-digit LCD display for an easy read-out of the measurement and tolerance indication. The tolerance values are shown graphically above the current measurement or the graphical display is full-size on the display. The 330° rotatable display guarantees an ideal read-out in any position. Easy and fast one-handed operation.

- Measuring range: \varnothing 6- 125 mm.
- Resolution: 0.001 mm.
- Accuracy: refer to the table. Only valid with close contact of all measuring surfaces.
- ABS/INC switchable.
- LCD display 330° rotatable.
- Digimatic data output.
- On/off switch.
- Reset/preset.
- Hold function.
- Adjustable tolerance limits.
- Measuring faces of hardened steel, with titanium nitride (TiN) coating.
- Conforms to factory standard.
- Delivery in a case.
- Power supply: 1 battery type V357.

Item No.	Measuring range/mm	Accuracy/mm	Price EUR
568.361	\varnothing 6- 8	± 0.005	1,171.00
568.362	\varnothing 8- 10	± 0.005	1,171.00
568.363	\varnothing 10- 12	± 0.005	1,171.00
568.364	\varnothing 12- 16	± 0.005	1,196.00
568.365	\varnothing 16- 20	± 0.005	1,196.00
568.366	\varnothing 20- 25	± 0.006	1,275.00
568.367	\varnothing 25- 30	± 0.006	1,275.00
568.368	\varnothing 30- 40	± 0.006	1,384.00
568.369	\varnothing 40- 50	± 0.006	1,384.00
568.370	\varnothing 50- 63	± 0.006	1,446.00
568.371	\varnothing 62- 75	± 0.006	1,477.00
568.372	\varnothing 75- 88	± 0.006	1,524.00
568.373	\varnothing 87- 100	± 0.006	1,524.00
568.374	\varnothing 100- 113	± 0.006	1,613.00
568.375	\varnothing 112- 125	± 0.006	1,639.00

Options:			
836.535	Spare battery		1.90
952.322	Extension 100 mm for Borematic \varnothing 6- 12 mm		95.00
952.621	Extension 150 mm for Borematic \varnothing 12- 20 mm		95.00
952.622	Extension 150 mm for Borematic \varnothing 20- 50 mm		105.00
952.623	Extension 150 mm for Borematic \varnothing 50- 300 mm		183.00

Sets

Sets consist of one measuring instrument with interchangeable measuring heads and setting rings.

Item No.	Measuring range/mm	Setting rings \varnothing /mm	Price EUR
568.924	\varnothing 6- 12	8, 10	1,696.00
568.925	\varnothing 12- 25	16, 20	1,821.00
568.926	\varnothing 25- 50	30, 40	2,143.00
568.927	\varnothing 50- 100 ¹	62, 87	3,641.00

¹ Measuring range by means of two sets of interchangeable measuring inserts per measuring head.



568.368

Data cables Digimatic, USB Input Tool Direct, U-WAVE available on request.



Three-point internal micrometers

Three-point internal micrometers with a clever pistol-shaped base instrument for quick, easy and accurate measurements of internal measures such as (blind) bores. Easy single handed operation for both right and left handed use. Available as single instruments and as sets, with setting ring(s) and extension.

- Measuring range: \varnothing 6- 100 mm.
- Measuring depth: 0- 270 mm.
- Read-out depends on the type of dial indicator or measuring probe.
- Clamping shaft: \varnothing 8 mm.
- Self-centering.
- Excl. dial indicator or measuring probe.
- Tungsten carbide measuring faces.
- Setting rings are conform to factory standard.
- Delivery in a case.



Separate instruments

Item No.	Measuring range/mm	Accuracy mm	Setting ring \varnothing /mm	Extension mm	Length/mm		Price EUR
					L	A	
907.770	\varnothing 6- 8	± 0.004	8	100	50	2	242.00
907.771	\varnothing 8- 10	± 0.004	8	100	50	2	245.00
907.772	\varnothing 10- 12	± 0.004	10	100	50	2	252.00
907.773	\varnothing 12- 16	± 0.004	16	150	65	0.5	254.00
907.774	\varnothing 16- 20	± 0.004	16	150	65	0.5	270.00
907.775	\varnothing 20- 25	± 0.004	25	150	91	0.5	287.00
907.776	\varnothing 25- 30	± 0.004	25	150	91	0.5	306.00
907.777	\varnothing 30- 40	± 0.004	40	150	97	0.5	329.00
907.778	\varnothing 40- 50	± 0.005	40	150	97	0.5	350.00
907.779	\varnothing 50- 63	± 0.005	62	150	112	0.5	373.00
907.780	\varnothing 62- 75	± 0.005	62	150	112	0.5	398.00
907.781	\varnothing 75- 88	± 0.005	87	150	112	0.5	423.00
907.782	\varnothing 87- 100	± 0.005	87	150	112	0.5	451.00

Sets

Item No.	Measuring range/mm	Setting ring(s) \varnothing /mm	Number of pistol grips	Extension mm	Price EUR
907.783	\varnothing 6- 12	8, 10	1	100	604.00
907.784	\varnothing 12- 20	16	1	150	446.00
907.785	\varnothing 20- 50	25, 40	2	150	1,097.00
907.786	\varnothing 50- 100	62, 87	1	150	1,348.00

Internal measuring instruments

- Measuring range: 6-450 mm.
- Read-out depends on the type of dial indicator.
- Incl. standard dial indicator 0-3 mm/0.01 mm.
- Clamping shaft: $\varnothing 8$ mm.
- Self-centering (except 907.230).
- Interchangeable measuring inserts with tungsten carbide stylus tip (907.230 with spherical measuring face).
- Also suitable for various dial indicators from e.g. Mitutoyo, TESA, Käfer and Peacock with clamping stem $\varnothing 8$ mm.



Item No.	Measuring range/mm	Measuring depth/mm	Price EUR
907.230	6- 10	40	77.00
907.231	10- 18	100	80.00
907.232	18- 35	125	63.00
907.233	35- 50	150	63.00
907.235	50-160	150	63.00
907.236	160-250	400	84.00
907.237	250-450	400	90.00



907.235+907.933



Optional dial indicators

Item No.	Measuring range/mm	Read-out mm	Accuracy mm	Price EUR
Analog:				
907.933	0-10	0.01	–	15.70
Digital (with determination of the reversal point):				
909.250	0-12.5	0.002	± 0.015	92.00
909.251	0-12.5	0.001	± 0.006	206.00
910.004	0-12.7	0.001	± 0.004	153.00



909.250/251



910.004

Peacock internal measuring instruments

- Measuring range: 6 - 400 mm.
- Read-out depends on the type of dial indicator.
- Clamping shaft: $\varnothing 8$ mm.
- Self-centering.
- Interchangeable measuring inserts with tungsten carbide stylus tip.
- Also suitable for various dial indicators from e.g. Mitutoyo, TESA and Käfer with clamping stem $\varnothing 8$ mm.



855.160



855.507

Item No.	Measuring range/mm	Measuring depth/mm	Price EUR
855.010	6 - 10	50	226.00
855.018	10 - 18	100	202.00
855.035	18 - 35	150	136.00
855.060	35 - 60	150	141.00
855.150	50 - 150	150	169.00
855.160	100 - 160	250	303.00
855.250	160 - 250	250	333.00
855.260	250 - 400	400	585.00
Option:			
855.507	Peacock dial indicator 0 - 10 mm, graduation 0.01 mm		32.10

Mitutoyo bore gauge set with dial indicator

Bore gauge set for measurement of holes and bores. The three measuring heads and three sets of measuring needles cover a measuring range of 18 - 150 mm.

- Measuring range: 18 - 150 mm.
- Measuring range dial indicator: 0 - 10 mm.
- Measuring depth:
 - 18 - 35 mm: 100 mm,
 - 35 - 150 mm: 150 mm.
- Graduation: 0.01 mm.
- Clamping shaft: $\varnothing 8$ mm.
- Interchangeable measuring inserts with tungsten carbide stylus tip.
- Plastic cover for dial indicator.
- Several accessories available.
- Delivery in a case incl. dial indicator (204.612), three measuring heads and three sets of measuring inserts.



Item No.	Measuring range/mm	Price EUR
511.921	18 - 150	439.00

Mitutoyo Absolute Digimatic internal measuring instrument

Internal measuring instrument with the absolute system for measurements in holes and tubes up to a depth of 2 m with an accuracy of ± 0.003 mm! Because the measuring system is built-in in the foot, the use of extensions does not influence the accuracy.

- Measuring range: 45 - 100 mm.
- Measuring depth with extensions: up to 2150 mm.
- Resolution: 0.001 mm.
- mm/inch conversion.
- Rotatable display.
- Digimatic data output.
- On/off switch.
- Preset.
- Hold function.
- Max. measuring speed: any.
- Max. measuring force: ≤ 5 N.
- Travel: 1.2 mm.
- Adjustable tolerance limits.
- Protection: IP53.
- Delivery in a case.
- Power supply: 2 batteries type V357.

Item No.	Measuring range/mm	Accuracy mm	Price EUR
511.501	45 - 100	± 0.003	1,144.00
Options:			
836.535	Spare battery (2 needed)		1.90
210.089	Extension 250 mm		451.00
210.081	Extension 500 mm		514.00



Kroepelin digital internal measuring instruments (3-point)

Kroepelin digital internal measuring instruments (3-point) for easier centering.

- Measuring range: 7 - 105 mm.
- Resolution: 0.002 or 0.005 mm.
- mm/inch conversion.
- ABS/INC switchable.
- With tolerance display.
- Protection: IP67.
- Delivery in a case with an inspection report.
- Power supply: 2 batteries AAA.

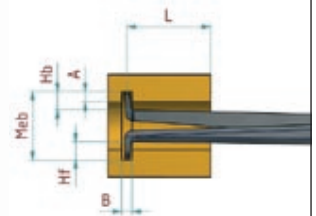

Item No.	Meas. depth L/mm	Groove depth A/mm	Groove width B/mm	Type of insert	Insert length Hb/mm
854.715	34	2.2	0.8	①	2.5
854.716	75	3.5	1.6	②	4.6
854.717	77	5.0	1.5	②	5.8
854.718	85	7.0	1.6	③	7.3
854.719	84	8.0	1.6	③	12.2
854.720	84	8.0	1.6	③	12.2
854.721	84	8.5	1.6	③	12.2
854.722	84	9.0	1.6	③	12.2

Types of inserts



Item No.	Measuring range/mm	Resolution mm	Accuracy mm	Repeatability mm	Price EUR
854.715	7 - 14	0.002	±0.01	0.004	439.40
854.716	10 - 20	0.005	±0.02	0.01	439.40
854.717	15 - 30	0.005	±0.02	0.01	439.40
854.718	25 - 45	0.005	±0.02	0.01	439.40
854.719	40 - 60	0.005	±0.02	0.01	439.40
854.720	55 - 75	0.005	±0.02	0.01	439.40
854.721	70 - 90	0.005	±0.02	0.01	439.40
854.722	85 - 105	0.005	±0.02	0.01	439.40

Options:

497.914	Spare battery type AAA	0.40
854.952*	Interface	39.20
965.013*	Digimatic cable	60.00
206.380*	USB cable	104.00
102.790*	U-WAVE cable	87.00

* For data output an interface and cable are needed. Only for new instruments with serial number ≥ I.

Schwenk internal measuring instruments

Internal measuring instruments used for measuring diameters of cylindrical bores and form deviations for instance roundness and cylindricity, compared to standards such as setting rings. In order to read out the measured values, any existing dial indicator or measuring probe with a clamping stem of $\varnothing 8$ mm can be used. The reversal point marks the diameter of the bores. When using digital indicators a model with a hold function for minimal measuring value is recommended.

- Measuring range: 4.5 - 800 mm.
- Read-out depends on the type of dial indicator or measuring probe.
- Accuracy: 4.5 - 290 mm: ≤ 0.002 mm,
280 - 800 mm: ≤ 0.003 mm.
- Repeatability: 4.5 - 290 mm: ≤ 0.0005 mm,
280 - 800 mm: ≤ 0.0015 mm.
- Clamping shaft: $\varnothing 8$ mm.
- Self-centering bridge.
- Measuring pins supplied with tungsten carbide ball tip.
- Interchangeable pins also available with steel or ruby ball tip.
- Centering bridge also available with a durable layer.
- Delivery in a case incl. pins, spacer rings (from 12 mm) and measuring report.
- Excl. dial indicator or measuring probe.
- Measuring depth extensions available on request.
- Sets consist of 2 or 3 instruments in one wooden box.



NEW

See for dial indicators the page "Schwenk precision dial indicators".

Sets

Item No.	Measuring range/mm	Measuring depth/mm	Price EUR
852.500	4.5 - 6	80	813.00
852.501	6 - 8	100	566.00
852.502	8 - 12	100	539.00
852.503	12 - 20	110	368.00
852.504	18 - 35	110	380.00
852.505	35 - 60	177	365.00
852.506	50 - 100	177	416.00
852.507	50 - 150	177	429.00
852.508	100 - 160	234	540.00
852.509	100 - 230	234	560.00
852.510	160 - 290	234	729.00
852.511	160 - 360	234	749.00
852.512	280 - 410	400	1,696.00
852.513	280 - 510	400	1,720.00
852.514	400 - 800	400	2,550.00

Item No.	Measuring range/mm	Number of instruments	Price EUR
851.925	18 - 100	3	1,094.00
852.752	18 - 150	3	1,107.00
851.926	50 - 160	2	923.00
852.624	50 - 230	2	887.00

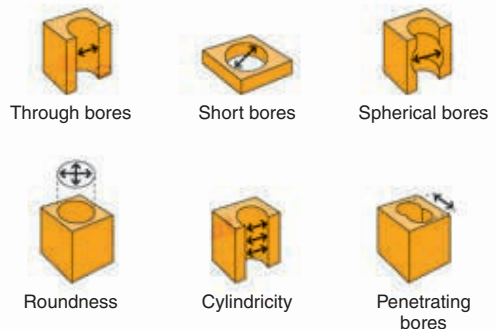

Schwenk internal measuring instruments for great depths

Special series of internal measuring instruments with extra long handles for measuring cylindric bores and form deviations of bores up to 2.5 meters.

- Measuring range: 4.5 - 800 mm.
- Measuring depth: 250 - 2500 mm.
- Read-out depends on the type of dial indicator or measuring probe.
- Clamping shaft: $\varnothing 8$ mm.
- Self-centering bridge with wear resistance coating.
- Fixed measuring probe supplied with tungsten carbide ball tip.
- Interchangeable probes supplied with tungsten carbide ball tip.
- Delivery in a case incl. interchangeable probes and spacer rings (from 12 mm).
- Excl. dial indicator or measuring probe.



Meas. depth	250 mm	500 mm	750 mm	1000 mm	1250 mm	1500 mm	2000 mm	2500 mm
Measuring range/mm	Item No. Price EUR	Item No. Price EUR	Item No. Price EUR	Item No. Price EUR	Item No. Price EUR	Item No. Price EUR	Item No. Price EUR	Item No. Price EUR
4.5 - 6	852.520 1,598.00							
6 - 8	852.521 1,156.00	852.522 1,276.00	852.523 1,332.00	852.524 1,412.00				
8 - 12	852.525 1,116.00	852.526 1,228.00	852.527 1,302.00	852.528 1,364.00				
12 - 20	852.529 688.00	852.530 887.00	852.531 931.00	852.532 1,018.00				
18 - 35	852.533 674.00	852.534 820.00	852.535 943.00	852.536 1,076.00	852.537 1,200.00			
35 - 60	852.538 656.00	852.539 807.00	852.540 926.00	852.541 1,151.00	852.542 1,187.00	852.543 1,204.00	852.544 1,297.00	852.545 1,625.00
50 - 100	852.546 798.00	852.547 943.00	852.548 974.00	852.549 1,249.00	852.550 1,302.00	852.551 1,355.00	852.552 1,531.00	852.553 1,766.00
50 - 150	852.554 820.00	852.555 966.00	852.556 997.00	852.557 1,271.00	852.558 1,324.00	852.559 1,382.00	852.560 1,555.00	852.561 1,793.00
100 - 160		852.562 1,098.00	852.563 1,253.00	852.564 1,409.00	852.565 1,491.00	852.566 1,665.00	852.567 1,771.00	852.568 2,010.00
100 - 230		852.569 1,134.00	852.570 1,288.00	852.571 1,444.00	852.572 1,531.00	852.573 1,705.00	852.574 1,807.00	852.575 2,040.00
160 - 290		852.576 1,497.00	852.577 1,651.00	852.578 1,793.00	852.579 1,891.00	852.580 2,380.00	852.581 2,510.00	852.582 2,740.00
160 - 360		852.583 1,537.00	852.584 1,691.00	852.585 1,833.00	852.586 1,925.00	852.587 2,420.00	852.588 2,550.00	852.589 2,780.00
280 - 410		852.590 2,640.00	852.591 2,760.00	852.592 3,300.00	852.593 3,360.00	852.594 3,610.00	852.595 4,120.00	852.596 4,510.00
280 - 510		852.597 2,690.00	852.598 2,800.00	852.599 3,350.00	852.600 3,410.00	852.601 3,650.00	852.602 4,170.00	852.603 4,570.00
500 - 800				852.604 4,330.00	852.605 4,440.00	852.606 4,620.00	852.607 5,180.00	852.608 5,560.00

See for dial indicators the page "Schwenk precision dial indicators".

Schwenk internal measuring instruments with ball probes

Special internal measuring instruments for measuring profiles and internal toothings without centering bridge. The fixed pin gauge and interchangeable inserts come with internal screw thread, in which ball probes can be placed.

- Measuring range: 8 - 510 mm.
- Read-out depends on the type of dial indicator or measuring probe.
- Accuracy: ≤ 0.002 mm.
- Repeatability: ≤ 0.0005 mm.
- Clamping shaft: $\varnothing 8$ mm.
- Ball probes available from $\varnothing 0.5$ mm, rising with 0.001 mm.
Deviation diameter: < 0.002 mm.
- Delivery in a case incl. interchangeable inserts and spacer ring(s).
- Excl. ball probes and dial indicator or measuring probe.



Internal measuring instruments

Item No.	Measuring range/mm	Measuring depth/mm	Price EUR
852.625	8 - 12	100	734.00
852.627	12 - 22	102	697.00
852.629	22 - 55	110	520.00
852.632	55 - 250	177	569.00
852.636	100 - 510	235	673.00
852.635	Adapter for ball probes (M1.6/M2.5)		27.40
852.091	Adapter for ball probes (M2.5/M4)		27.40

See for dial indicators the page "Schwenk precision dial indicators".

Item No.	Diameter mm	Thread	Price EUR
Set of ball probes (pair)¹ for 852.625:			
852.107	1	M1.6	138.00
852.004	1.5	M1.6	138.00
852.005	2	M1.6	138.00
Set of ball probes (pair)¹ for 852.627:			
852.982	1	M1.6	130.00
852.006	1.5	M1.6	130.00
852.007	2	M1.6	130.00
852.008	2.5	M1.6	130.00
852.009	3	M1.6	130.00
852.675	3.5	M1.6	130.00
852.671	4	M1.6	130.00
Set of ball probes (pair)¹ for 852.629:			
852.092	1	M2.5	130.00
852.010	1.5	M2.5	130.00
852.011	2	M2.5	130.00
852.012	2.5	M2.5	130.00
852.674	3	M2.5	130.00
852.650	3.5	M2.5	130.00
852.676	4	M2.5	130.00
852.651	4.5	M2.5	130.00
852.677	5	M2.5	130.00
852.013	5.5	M2.5	130.00
852.655	6	M2.5	130.00
852.014	6.5	M2.5	130.00
852.678	7	M2.5	130.00
852.015	7.5	M2.5	174.00
852.016	8	M2.5	174.00
852.017	8.5	M2.5	174.00
852.018	9	M2.5	174.00
852.019	9.5	M2.5	174.00
852.020	10	M2.5	130.00
Set of ball probes (pair)¹ for 852.632:			
852.021	1	M4	130.00
852.022	1.5	M4	130.00
852.023	2	M4	130.00
852.116	2.5	M4	130.00
852.670	3	M4	130.00
852.653	3.5	M4	130.00
852.913	4	M4	130.00
852.186	4.5	M4	130.00
852.672	5	M4	130.00
852.195	5.5	M4	130.00
852.673	6	M4	130.00
852.024	6.5	M4	130.00
852.914	7	M4	130.00
Set of ball probes (pair)¹ for 852.636:			
852.025	7.5	M4	174.00
852.026	8	M4	174.00
852.027	8.5	M4	174.00
852.657	9	M4	174.00
852.028	9.5	M4	174.00
852.656	10	M4	174.00

¹ Special sizes on request.

Schwenk Vario internal measuring instruments

The Vario internal measuring instruments come with an extra high centering bridge that gives a more stable alignment, which means that it is no longer necessary to look for the reversal point. In this way, the internal measuring instruments are highly useful for serial inspection.

- Measuring range: 20-170 mm.
- Read-out depends on the type of dial indicator or measuring probe.
- Accuracy: ≤ 0.002 mm.
- Repeatability: ≤ 0.001 mm.
- Clamping shaft: $\varnothing 8$ mm.
- High self-centering and self-aligning bridge.
- Fixed measuring probe supplied with tungsten carbide ball tip.
- Interchangeable probes supplied with tungsten carbide ball tip.
- Short handle.
- Delivery in a case incl. interchangeable probes and spacer rings.
- Excl. dial indicator or measuring probe.

Item No.	Measuring range/mm	a mm	Price EUR
852.610	20- 35	21	473.00
852.611	35- 55	23	454.00
852.612	50- 80	24	508.00
852.613	80-120	24	518.00
852.614	120-170	30	673.00

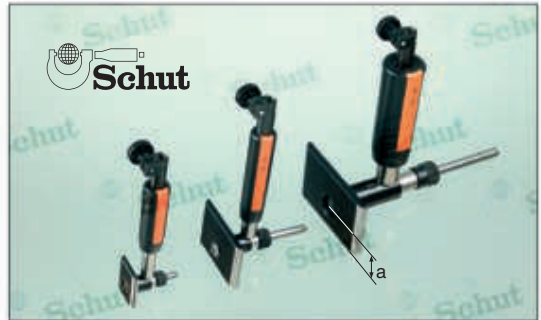

See for dial indicators the page "Schwenk precision dial indicators".

Schwenk internal measuring instruments for blind bores

These internal measuring instruments have been designed in such a way that they can measure the roundness and cylindricity of blind bores almost to the bottom. The adjustable measuring axis can be changed easily, and is equipped with ruling and tothing, so it can't move during measurement.

- Measuring range: 20-400 mm (up to 600 mm on request).
- Read-out depends on the type of dial indicator or measuring probe.
- Accuracy: 20- 60 mm: ≤ 0.004 mm,
50-400 mm: ≤ 0.0025 mm.
- Repeatability: ≤ 0.001 mm.
- Clamping shaft: $\varnothing 8$ mm.
- Self-centering bridge.
- Fixed measuring probe supplied with tungsten carbide ball tip.
- Interchangeable, adjustable measuring axes standard supplied with tungsten carbide ball tip.
- Fixed probe and interchangeable axes also available with ruby ball tip.
- Distance ball tips to bottom blind bores (h):
20-140 mm: 1.5 mm, 110-400 mm: 2.0 mm.
- Delivery in a case incl. interchangeable axes.
- Excl. dial indicator or measuring probe.

Item No.	Measuring range/mm	MT mm	h mm	Price EUR
852.615	20- 50	77	1.5	695.00
852.616	20- 60	77	1.5	734.00
852.617	50-110	60	1.5	673.00
852.618	50-140	60	1.5	718.00
852.619	110-300	90	2.0	941.00
852.620	110-400	90	2.0	1,138.00

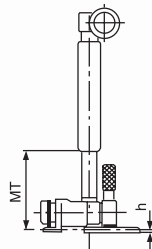

See for dial indicators the page "Schwenk precision dial indicators".

Schwenk Rabito internal measuring instruments

The design of the Rabito internal measuring instruments is based on Schwenk's well-proven principle, and has been developed to offer a high accuracy at a low price. Due to the robust construction very suited for use in the clean room as well as for batch measurements on the production floor.

- Measuring range: 18 - 150 mm.
- Read-out depends on the type of dial indicator or measuring probe.
- Accuracy: ≤ 0.004 mm.
- Repeatability: ≤ 0.002 mm.
- Clamping shaft: $\varnothing 8$ mm.
- Travel: 1.4 mm (18 - 25 mm: 1.3 mm).
- Fixed and interchangeable measuring probes supplied with tungsten carbide ball tip.
- Item 852.957 consists of item 852.954, an extension up to 50 mm and item 852.956.
- Delivery in a case incl. interchangeable probes and spacer rings. Excl. setting rings and dial indicator or measuring probe.



Item No.	Measuring range/mm	Measuring depth/mm	Price EUR
852.954	18 - 35	176	208.00
852.955	35 - 60	178	202.00
852.956	50 - 150	178	234.00
852.957	18 - 150	178	407.00

See for dial indicators the page "Schwenk precision dial indicators".

Schwenk internal measuring instruments/contourmeters

Internal measuring instruments to measure the cross-sections of round and not-round bores. The surface may be smooth or rough.

- Measuring range: 14 - 180 mm.
- Graduation: 0.1 mm.
- Stainless steel strip.
- Tape width: 20 mm.
- Delivery in a case.
- Available on request:
 - for larger diameters up to 330 mm,
 - with measuring report,
 - digital model (incl. display).



Item No.	Measuring range/mm	Price EUR
852.683	14 - 24	604.00
852.684	22 - 40	592.00
852.685	35 - 60	265.00
852.697	55 - 100	281.00
852.937	95 - 180	351.00



TESA CNC presetting bench units TPS 300/500/1000

The TESA TPS CNC universal presetting benches are specially designed for checking and presetting all kind of 2-point and 3-point handheld tools used for both internal and external measurements up to 1040 mm. The need for a wide variety of setting standards such as ring gauges and gauges blocks is eliminated. By using universal accessories the instrument is suitable for presetting and checking micrometers, calipers, dial indicators, dial test indicators, three-point internal micrometers and internal measuring instruments from various manufacturers.

- The preset values and the motorized position movement allow instantaneous use of the instrument.
- All entered preset values respect ISO/DIN 286 tolerances. Individual tolerances can be programmed.
- Internal measuring range:
 - TPS 300: 4.5 - 305 mm,
 - TPS 500: 4.5 - 508 mm,
 - TPS 1000: 10 - 1016 mm.
- External measuring range:
 - TPS 300: 40 - 330 mm,
 - TPS 500: 40 - 532 mm,
 - TPS 1000: 40 - 1040 mm.
- Resolution: 0.001 mm.
- Accuracy at $20 \pm 0.5^\circ\text{C}$ and a relative humidity of $50 \pm 5\%$: $\pm(1.5 + L/300) \mu\text{m}$ (L in mm).
- Repeatability: 0.001 mm.
- RS232C data output.
- Measuring force: 10 N.
- Dimensions and weight:
 - TPS 300: 610 x 300 x 270 mm, 50 kg,
 - TPS 500: 820 x 300 x 300 mm, 75 kg,
 - TPS 1000: 1330 x 340 x 300 mm, 300 kg.
- Three rubber feet acting like vibration inhibitors.
- Delivery with an inspection report and a declaration of conformity.
- Power supply: 80 - 240 V, 50 - 60 Hz.



Item No.	Type	Price EUR
782.848	TPS 300	
782.849	TPS 500	
782.850	TPS 1000	

Options

Item No.	Measuring range/mm	Price EUR
Self-centering internal meas. instr. (2-point):		
782.951	4.5 - 6	
782.952	6 - 12.5	
782.953	12 - 25	
782.954	25 - 50	
782.955	50 - 150	
782.956	150 - 300	
782.957	240 - 550	
Internal meas. instr. (2-point, small bores):		
782.959	6 - 12.5	
Internal measuring instruments (2-point):		
782.961*	10 - 150	
Micrometers and external meas. instruments:		
782.960*	40 - 1040	
TESA Inotest:		
782.962*	50 - 1040	
Dial indicators (clamping stem $\varnothing 8$ mm):		
782.966	10 - 150	
Dial test indicators:		
782.967	Dial indicator stand	

* Two needed.



Ask for
the detailed
brochure

Mitutoyo setting instrument for internal measuring instruments

This instrument offers you the best way to accurately zero-set your internal measuring instruments with dial indicator. Gauge blocks are used to set the exact reference value. The special receivers assure that the centering device of the micrometer also functions when in use on this instrument, making the checking just as easy as measuring.

The complete instrument (excl. gauge blocks) consists of:

- 1 stand with double guidance, for measuring ranges up to 400 mm,
- 1 receiver for measuring ranges 18 - 35 and 35 - 60 mm,
- 1 receiver for measuring ranges 50 - 100 and 100 - 160 mm,
- 1 receiver for measuring ranges 100 - 250 and 250 - 400 mm,
- 2 flat measuring jaws.



Item No.	Adjustment range/mm	Price EUR
515.590	18 - 400	1,383.00



Mitutoyo setting instruments for stick micrometers

This instrument has been especially developed for the calibration of stick micrometers. It consists of a step gauge with ceramic gauge blocks, two clamping elements with V-shaped supports and two 10 mm ceramic gauge blocks.

The ceramic gauge blocks can be clamped to the step gauge at any desired distance of each other. In that way the stick micrometer that has to be checked rests perfectly aligned on the V-shaped supports and touches the gauge blocks with its measuring points. Only suited for mechanical stick micrometers.

- Adjustment range: 25 - 600 mm.
- Increment: 25 mm.
- Max. deviation: 25 - 300 mm: 0.003 mm,
300 - 600 mm: 0.005 mm.
- Conforms to factory standard.
- Delivery in a case.



515.585

Item No.	Adjustment range/mm	Price EUR
515.585	25 - 300	1,543.00
515.586	25 - 600	3,258.00

Setting instrument for internal measuring instruments

This instrument offers you the best way to accurately zero-set your internal measuring instruments with dial indicator. Gauge blocks are used to set the exact reference value. The special receiver assures that the centering device of the micrometer also functions when in use on this instrument, making the checking just as easy as measuring.

- Adjustment range: 18 - 400 mm.
- The setting instrument consists of a stand with double guidance and a flat measuring jaw.
- Excl. gauge blocks.
- Delivery in a case.



Item No.	Adjustment range/mm	Price EUR
907.877	18 - 400	527.00

Setting gauges for inside micrometers

Used for setting of inside micrometers.

- Measuring range: 0 - 275 mm.



Item No.	Length mm	Accuracy mm	Parallelism mm	Price EUR
910.005	50	±0.003	0.003	25.50
910.006	75	±0.004	0.004	35.70
910.007	100	±0.005	0.005	46.00
910.008	150	±0.005	0.005	66.00
910.009	200	±0.005	0.005	92.00
910.010	250	±0.005	0.005	128.00
910.011	275	±0.005	0.005	148.00

Stick micrometers

- Measuring range: 50 - 600 mm.
- Graduation: 0.01 mm.
- Locking screw (except 906.078).
- Spherical tungsten carbide measuring faces: $\varnothing 8 \times 8$ mm (906.078/079: $\varnothing 9 \times 2.5$ mm).
- With insulating grips (only 906.083 - 906.099).
- Excl. setting gauge.



906.080



906.096



Item No.	Measuring range/mm	Accuracy mm	Price EUR
906.078	50 - 75	± 0.006	35.60
906.079	75 - 100	± 0.006	40.00
906.080	100 - 125	± 0.006	45.00
906.081	125 - 150	± 0.008	50.00
906.082	150 - 175	± 0.008	54.00
906.083	175 - 200	± 0.008	56.00
906.084	200 - 225	± 0.009	63.00
906.085	225 - 250	± 0.009	64.00
906.086	250 - 275	± 0.009	72.00
906.087	275 - 300	± 0.009	77.00
906.088	300 - 325	± 0.009	82.00

Item No.	Measuring range/mm	Accuracy mm	Price EUR
906.089	325 - 350	± 0.009	87.00
906.090	350 - 375	± 0.010	95.00
906.091	375 - 400	± 0.010	101.00
906.092	400 - 425	± 0.010	107.00
906.093	425 - 450	± 0.010	112.00
906.094	450 - 475	± 0.011	117.00
906.095	475 - 500	± 0.011	122.00
906.096	500 - 525	± 0.011	126.00
906.097	525 - 550	± 0.011	131.00
906.098	550 - 575	± 0.011	136.00
906.099	575 - 600	± 0.011	155.00

Stick micrometer sets

- Measuring range: 50 - 5000 mm.
- Measuring range micrometer:
 906.911 - 906.917: 50- 63 mm,
 906.918: 150- 175 mm,
 906.919 - 906.923: 1000- 1050 mm.
- Graduation: 0.01 mm.
- Accuracy:
 906.911 - 906.918: $\pm(3+n+L/50) \mu\text{m}$,
 906.919 - 906.923: $\pm(7+n+L/50) \mu\text{m}$
 (n = number of extensions,
 L = max. measuring length in mm).
- Locking screw.
- Spherical tungsten carbide measuring faces.
- With insulating grips
 (only 906.918 - 906.923).
- External diameter micrometer/extensions:
 906.911 - 906.917: 15.5 mm,
 906.918: 22 mm,
 906.919 - 906.923: 28 mm.
- Incl. setting gauge
 (only 906.911 - 917: 50 mm,
 906.918: 150 mm).
- Delivery in a case.



906.918

Item No.	Measuring range/mm	Number of extensions	Price EUR
906.911*	50- 63	–	63.00
906.912	50- 100	2	67.00
906.913	50- 150	3	71.00
906.914	50- 300	5	97.00
906.915	50- 500	6	121.00
906.916	50-1000	8	387.00
906.917	50-1500	10	757.00
906.918	150-2000	9	867.00
906.919*	1000- 1050	–	371.00
906.920	1000-2000	5	742.00
906.921	1000-3000	6	1,485.00
906.922	1000-4000	7	2,970.00
906.923	1000-5000	8	5,930.00

* Single instrument (without extensions).



Digital stick micrometer sets

- Measuring range: 150 - 2000 mm.
- Measuring range micrometer: 150 - 175 mm.
- Resolution: 0.001 mm.
- Locking screw.
- Spherical tungsten carbide measuring faces.
- With insulating grips
 (only 906.797 - 906.799).
- External diameter micrometer/extensions:
 22 mm.
- Incl. setting gauge: 150 mm.
- Delivery in a case.



906.796

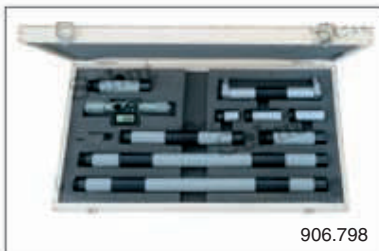

906.798

Item No.	Measuring range/mm	Number of extensions	Accuracy μm	Price EUR
906.796*	150- 175	–	6.5	226.00
906.797	150-1000	6	29	475.00
906.798	150-1500	8	41	806.00
906.799	150-2000	9	52	917.00

* Single instrument (without extensions).



Inside micrometers with interchangeable anvils

Screw thread micrometers for internal measurements of pitch diameters. The interchangeable anvils allow measurements of several kinds of screw thread.

- Measuring range: 75 - 300 mm.
- Graduation: 0.01 mm.
- Insert shaft: $\varnothing 5$ mm.
- Delivery incl. setting gauge for metric thread, 60° flank angle.



Item No.	Measuring range/mm	Accuracy mm	Price EUR
Inside micrometers without inserts:			
906.924	75 - 100	± 0.025	79.00
906.925	100 - 125	± 0.028	88.00
906.926	125 - 150	± 0.030	97.00
906.927	150 - 175	± 0.033	107.00
906.928	175 - 200	± 0.035	116.00
906.929	200 - 225	± 0.038	120.00
906.930	225 - 250	± 0.040	134.00
906.931	250 - 275	± 0.043	137.00
906.932	275 - 300	± 0.045	153.00

Item No.	Threads per inch	Price EUR
Inserts for Whitworth threads, 55° flank angle, per pair:		
906.940	60 - 48	18.40
906.941	48 - 40	18.40
906.942	40 - 32	18.40
906.944	32 - 24	18.40
906.945	24 - 18	18.40
906.946	18 - 14	18.40
906.947	14 - 10	18.40
906.948	10 - 7	18.40
906.949	7 - 4.5	18.40
906.950	4.5 - 3.5	18.40
906.951	Set 60 - 3.5	142.00

Item No.	Pitch/mm	Price EUR
Inserts for metric threads, 60° flank angle, per pair:		
906.933	0.4 - 0.5	17.10
906.934	0.6 - 0.9	17.10
906.935	1 - 1.75	18.40
906.936	2 - 3	18.40
906.937	3.5 - 5	18.40
906.938	5.5 - 7	18.40
906.939	Set 0.4 - 7	92.00

Item No.	Threads per inch	Price EUR
Inserts for UN, UNC and UNF threads, 60° flank angle, per pair:		
906.952	64 - 48	18.40
906.953	44 - 28	18.40
906.954	24 - 14	18.40
906.955	13 - 9	18.40
906.956	8 - 5	18.40
906.957	4.5 - 3.5	18.40
906.958	Set 64 - 3.5	92.00

Internal micrometers

Internal micrometers with special measuring jaws for measurements in hard-to-reach places.

- Measuring range: 5 - 200 mm.
- Analog: graduation 0.01 mm, digital: resolution 0.001 mm.
- Tungsten carbide cylindrical measuring faces.
- Internal micrometers within measuring range 5 - 50 mm are delivered incl. setting ring.
- Delivery in a case.

Analog

- No-glare chrome finished design.

Digital

- mm/inch conversion.
- ABS/INC switchable.
- Automatic switch-off.
- Reset/preset.
- Power supply: 1 battery type V357.



906.509



909.974

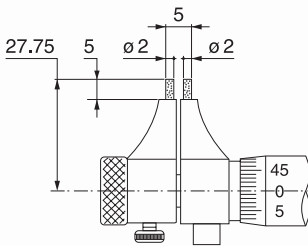

906.509 / 909.974

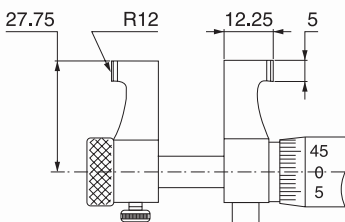

906.510-533 / 909.975-981



906.510-533 / 909.975-981



Item No.	Measuring range/mm	Accuracy mm	Price EUR
Analog:			
906.509	5- 30	±0.005	48.00
906.510	25- 50	±0.006	52.00
906.511	50- 75	±0.007	60.00
906.512	75-100	±0.008	68.00
906.530	100-125	±0.009	77.00
906.531	125-150	±0.009	85.00
906.532	150-175	±0.010	93.00
906.533	175-200	±0.010	95.00
Digital:			
909.974	5- 30	±0.005	157.00
909.975	25- 50	±0.006	164.00
909.976	50- 75	±0.007	171.00
909.977	75-100	±0.008	178.00
909.978	100-125	±0.009	185.00
909.979	125-150	±0.009	196.00
909.980	150-175	±0.010	206.00
909.981	175-200	±0.010	220.00
Option:			
836.535	Spare battery		1.90

Groove micrometers

Micrometers for measuring e.g. steps in bores and internal cross grooves. With double graduation for internal and external measurements. By means of the disk-shaped measuring faces the wide, depth and location of grooves in bores can be determined.

- Measuring range:
 - external measuring: 0 - 100 mm,
 - internal measuring: 1.6- 101.5 mm.
- Graduation: 0.01 mm.
- Accuracy: ± 0.01 mm.
- Diameter measuring faces:
 - 907.137: 6.5 mm,
 - 907.138-907.141: 13 mm.
- Double graduation.

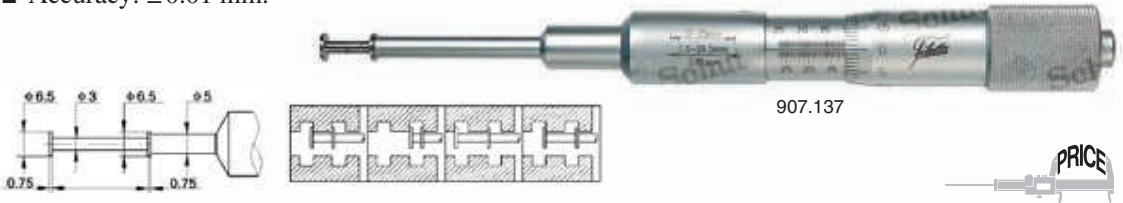

Item No.	Ext. measuring range/mm	Int. measuring range/mm	Price EUR
907.137	0- 25	1.6- 26.5	222.00
907.138	0- 25	1.6- 26.5	222.00
907.139	25- 50	26.5- 51.5	258.00
907.140	50- 75	51.5- 76.5	298.00
907.141	75- 100	76.5- 101.5	343.00

Two-point internal measuring instruments

- Measuring range: 20- 150 mm.
- Graduation: 0.01 mm.
- Interchangeable measuring inserts.
- Delivery in a case with an measuring inserts.



Item No.	Measuring range/mm	A _{max} mm	C _{min} mm	D _{max} mm	Price EUR
855.501	20- 34	60	2	3	283.00
855.502	30- 60	75	2.5	5	283.00
855.503	55- 150	90	4	9	325.00

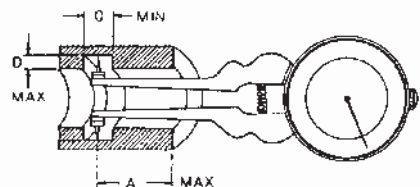

Interapid internal measuring instrument

Bore measuring instrument with a large measuring range without having to change the measuring inserts. Specially suitable for measuring by comparison.

- Measuring range: 10-150 mm.
- Scale range: ± 0.20 mm.
- Measuring depth depends on the measured value.
- Graduation: 0.01 mm.
- Choice between 2- and 3-point measurements.
- Locking mechanism.
- Fine adjustment.
- Delivery with a declaration of conformity.



Item No.	Description	Price EUR
781.505	Set 1 with hardened steel inserts	2,283.00
781.506	Set 2 with tungsten carbide inserts	2,410.00
Options:		
781.507	1 hardened steel insert	10.00
781.508	1 hardened steel small needle insert	9.60
781.509	1 hardened steel long needle insert	9.60
781.515	1 tungsten carbide insert	62.00
781.516	Set of small winged inserts (2 single and 1 double)	145.00
781.517	Set of large winged inserts (2 single and 1 double)	151.00
781.518	Holder	180.00

- Set 1:**
- Interapid internal measuring instrument,
 - 3 hardened steel inserts (A),
 - 3 hardened steel small needle inserts,
 - 3 hardened steel long needle inserts,
 - 2 adjustable contact arms for measurements from $\phi 6$ mm (781.510),
 - 1 small insert holder for 3-point measuring (781.511),
 - 1 large insert holder for 3-point measuring (781.512),
 - 1 centering device for measuring range $\phi 15 - 30$ mm (781.513),
 - 1 centering device for measuring range $\phi 30 - 150$ mm (781.514).
- Set 2:**
- Similar to set 1, the hardened steel inserts (A) are replaced with tungsten carbide ones.

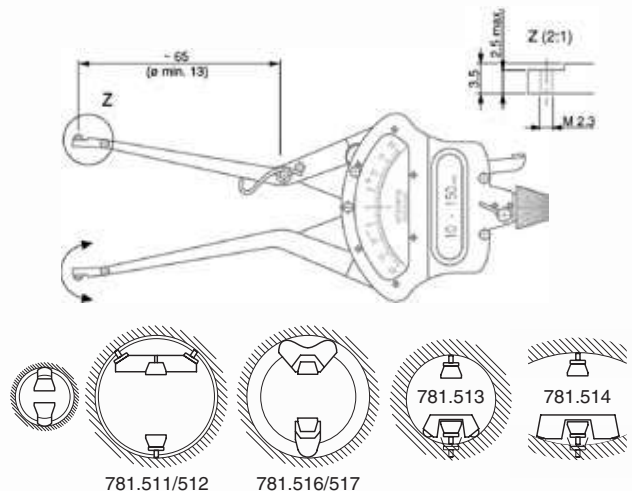
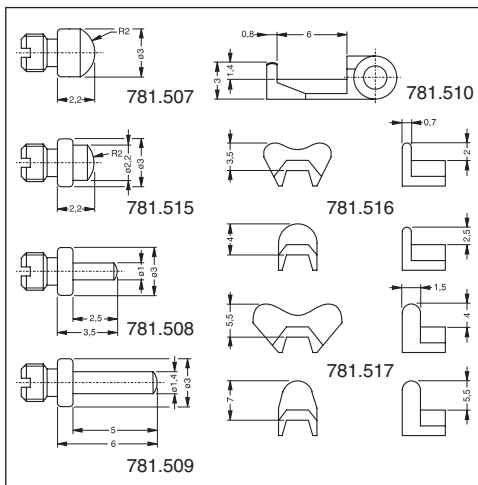

Diatest crankshaft meters

- Measuring range: 45 - 500 mm.
- Graduation: 0.01 mm.
- Rotatable dial.
- Delivery with dial indicator, counter-weight and extensions in a case.



Item No.	Measuring range/mm	Price EUR
831.469	45 - 150	347.00
831.470	60 - 300	313.00
831.471	60 - 500	352.00
Options:		
831.472	Separate dial indicator for 831.469	214.00
831.473	Counterweight for 831.469	9.70
831.474	Separate dial indicator for 831.470 and 831.471	183.00
831.475	Counterweight for 831.470 and 831.471	9.70



Crankshaft meters

- Measuring range: 60 - 500 mm.
- Graduation: 0.01 mm.
- Rotatable dial.
- Delivery with dial indicator, counter-weight and extensions in a case.

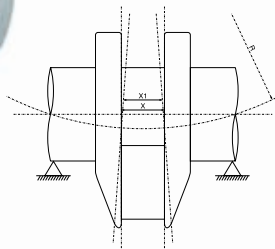

907.919



Item No.	Measuring range/mm	Price EUR
907.918	60 - 300	130.00
907.919	60 - 500	137.00
Option:		
907.917	Separate dial indicator	85.00

Telescopic gauges

In places that are hard to reach with standard measuring instruments, you can use these telescopic gauges. The spring gauge is put into the bore, centers itself, after that you can turn on the locking screw. Then the gauge is pulled out and you can measure the result, for instance with a micrometer.

- Measuring range: 8 - 150 mm.
- Chrome finished.

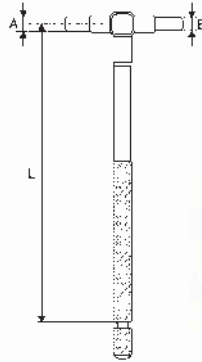

Individual gauges

Item No.	Measuring range/mm	Dimensions/mm			Price EUR
		L	A	B	
906.604	8 - 12.7	102	4	3	3.50
906.605	12.7 - 19	102	5	4	3.30
906.606	19 - 32	102	5	4	3.30
906.607	32 - 54	127	7.5	6	3.30
906.608	54 - 90	127	7.5	6	3.30
906.609	90 - 150	127	7.5	6	3.80

Set of gauges

Item No.	Measuring range/mm	Price EUR
906.610	8 - 150	17.30



Plug gauges for small bores (blind/through)

Ideal for measuring of small bores (blind and through) and grooves. The spring gauge is put into the bore, centers itself, after that you can turn on the locking screw. Then the gauge is pulled out and you can measure the result, for instance with a micrometer. Separate set for blind bores and through bores.

- Measuring range: 3 - 13 mm (4 gauges: 3-5 mm, 5-7.5 mm, 7.5-10 mm and 10-13 mm).
- Chrome finished.



907.747



907.748

Set of gauges

Item No.	Description	Price EUR
907.747	For blind bores	18.20
907.748	For through bores	18.20



Digital internal measuring instrument

- Measuring range: 12.7 - 170 mm.
- Resolution: 0.1 mm.
- Accuracy: ± 0.2 mm.
- mm/inch conversion.
- On/off switch.
- Automatic switch-off.
- Reset.
- Hold function.
- Locking screw.
- Power supply: 1 battery type CR2032.

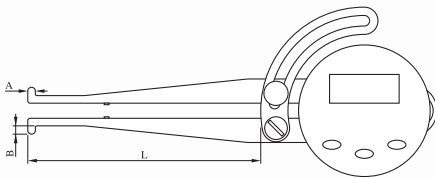
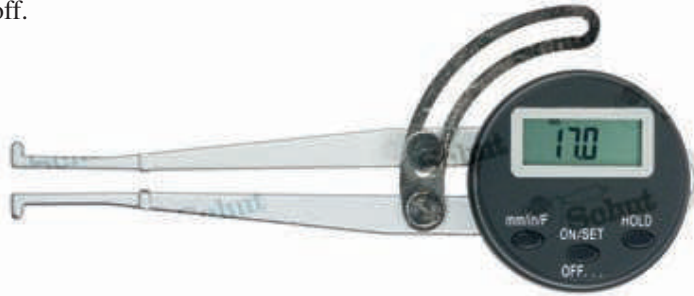

Item No.	Measuring range/mm	Length/mm			Price EUR
		L	A	B	
909.409	12.7 - 170	85	3	3	49.00
Option: 495.157 Spare battery					0.50

Digital external measuring instrument

- Measuring range: 0 - 160 mm.
- Resolution: 0.1 mm.
- Accuracy: ± 0.2 mm.
- mm/inch conversion.
- On/off switch.
- Automatic switch-off.
- Reset.
- Hold function.
- Locking screw.
- Power supply: 1 battery type CR2032.



Item No.	Measuring range/mm	Length/mm			Price EUR
		L	A	B	
909.408	0 - 160	85	3	25	49.00
Option: 495.157 Spare battery					0.50

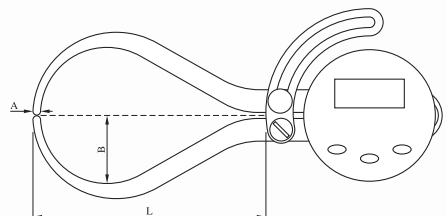

Digital internal measuring instruments

Digital internal measuring instruments for measurements of bores, internal grooves and other hard-to-reach places.

- Measuring range: 5 - 60 mm.
- Resolution: 0.005 mm. Digital-analog display changes automatically between 0.01, 0.02 and 0.05 mm (± 20 scale divisions).
- mm/inch conversion.
- ABS/INC switchable.
- Large LCD display, 340° rotatable.
- On/off switch.
- Automatic switch-off.
- Reset/preset.
- Hold and min/max functions.
- Adjustable tolerance limits.
- Measuring faces with different contact forms.
- Power supply: 1 battery type CR2032.



908.810



Item No.	Measuring range/mm	Accuracy mm	Length/mm			Contact form/mm	Price EUR
			L	A	B		
Travel 10 mm:							
908.810	5-15	± 0.02	20	1	1.5	① R 0.3	116.00
908.811	10-20	± 0.02	25	1.5	3.0	① R 0.3	126.00
908.812	20-30	± 0.02	30	2	6.5	① R 0.5	126.00
908.813	30-40	± 0.02	30	2.5	9.0	① R 0.5	126.00
908.814	40-50	± 0.02	30	2.5	9.0	① R 0.5	126.00
908.816	10-20	± 0.02	25	1.5	3.0	② $\varnothing 1.5$	145.00
908.817	20-30	± 0.02	30	2	6.5	② $\varnothing 1.5$	145.00
908.818	30-40	± 0.02	30	2.5	9.0	② $\varnothing 1.5$	145.00
908.819	40-50	± 0.02	30	2.5	9.0	② $\varnothing 1.5$	145.00
Travel 20 mm:							
908.820	5-25	± 0.03	35	1	1.5	① R 0.3	126.00
908.821	10-30	± 0.03	55	2	3.5	① R 0.5	139.00
908.822	20-40	± 0.03	80	3	6.5	① R 0.5	139.00
908.823	30-50	± 0.03	80	3	8.5	① R 0.5	139.00
908.824	40-60	± 0.03	80	3	8.5	① R 0.5	145.00
908.826	10-30	± 0.03	55	2	3.5	② $\varnothing 1.5$	160.00
908.827	20-40	± 0.03	80	3	6.5	② $\varnothing 1.5$	160.00
908.828	30-50	± 0.03	80	3	8.5	② $\varnothing 1.5$	160.00
908.829	40-60	± 0.03	80	3	8.5	② $\varnothing 1.5$	166.00
Option: 495.157 Spare battery							0.50

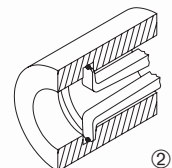
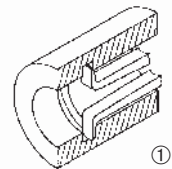
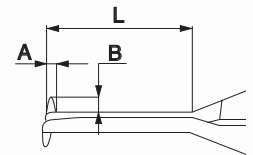

Internal measuring instruments

Internal measuring instruments for measurements of bores, internal grooves and other hard-to-reach places.

- Measuring range: 5 - 60 mm.
- Graduation: 0.01 mm.
- Rotatable dial.
- Adjustable tolerance markers.
- Measuring faces with different contact forms.



908.830



Item No.	Measuring range/mm	Accuracy mm	Length/mm			Contact form/mm	Price EUR
			L	A	B		
Travel 10 mm:							
908.830	5 - 15	±0.02	20	1	1.5	① R 0.3	105.00
908.831	10 - 20	±0.02	25	1.5	3.0	① R 0.3	113.00
908.832	20 - 30	±0.02	30	2	6.5	① R 0.5	113.00
908.833	30 - 40	±0.02	30	2.5	9.0	① R 0.5	113.00
908.834	40 - 50	±0.02	30	2.5	9.0	① R 0.5	113.00
908.836	10 - 20	±0.02	25	1.5	3.0	② ø1.5	130.00
908.837	20 - 30	±0.02	30	2	6.5	② ø1.5	130.00
908.838	30 - 40	±0.02	30	2.5	9.0	② ø1.5	130.00
908.839	40 - 50	±0.02	30	2.5	9.0	② ø1.5	130.00
Travel 20 mm:							
908.840	5 - 25	±0.03	35	1	1.5	① R 0.3	113.00
908.841	10 - 30	±0.03	55	2	3.5	① R 0.5	125.00
908.842	20 - 40	±0.03	80	3	6.5	① R 0.5	125.00
908.843	30 - 50	±0.03	80	3	8.5	① R 0.5	125.00
908.844	40 - 60	±0.03	80	3	8.5	① R 0.5	130.00
908.846	10 - 30	±0.03	55	2	3.5	② ø1.5	144.00
908.847	20 - 40	±0.03	80	3	6.5	② ø1.5	144.00
908.848	30 - 50	±0.03	80	3	8.5	② ø1.5	144.00
908.849	40 - 60	±0.03	80	3	8.5	② ø1.5	150.00

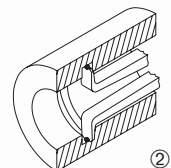
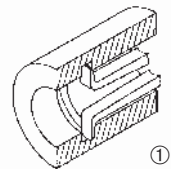
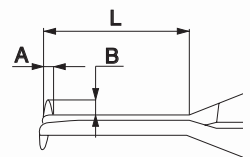

Krœplin digital internal measuring instruments

Krœplin's new generation of quickest measuring instruments has a compact, ergonomical design. The digital-analog display makes read-out easier.

- Measuring range: 2.5 - 120 mm.
- Resolution: 0.005, 0.01, 0.02 or 0.025 mm.
- mm/inch conversion.
- ABS/INC switchable.
- Mitutoyo Digimatic, Mitutoyo U-WAVE and USB data outputs optionally available.
- With tolerance display.
- Purpose-built measuring program and measuring inserts.
- Protection: IP67.
- Delivery in a case with an inspection report.
- Power supply: 2 batteries type AAA.



854.915

Item No.	Measuring range/mm	Resolution mm	Accuracy mm	Repeatability mm	Price EUR
854.913	2.5 - 12.5	0.005	±0.015	0.005	365.60
854.914	5 - 15	0.005	±0.015	0.005	365.60
854.915	10 - 30	0.01	±0.03	0.01	365.60
854.916	20 - 40	0.01	±0.03	0.01	365.60
854.917	30 - 50	0.01	±0.03	0.01	365.60
854.918	40 - 60	0.01	±0.03	0.01	365.60
854.919	50 - 70	0.01	±0.03	0.01	365.60
854.920	60 - 80	0.01	±0.03	0.01	365.60
854.921	70 - 90	0.01	±0.03	0.01	365.60
854.960	80 - 100	0.01	±0.03	0.01	365.60
854.012	13 - 43	0.02	±0.04	0.02	365.60
854.013	30 - 60	0.02	±0.04	0.02	365.60
854.014	50 - 80	0.02	±0.04	0.02	365.60
854.015	70 - 100	0.02	±0.04	0.02	365.60
854.016	90 - 120	0.02	±0.04	0.02	365.60
854.017	15 - 65	0.025	±0.06	0.04	505.60
854.018	40 - 90	0.025	±0.06	0.04	505.60
Options:					
497.914	Spare battery type AAA				0.40
854.952*	Interface				39.20
965.013*	Digimatic cable				60.00
206.380*	USB cable				104.00
102.790*	U-WAVE cable				87.00



For specifications refer to the Krœplin internal measuring instruments overview.

*For data output an interface and cable are needed. Only for new instruments with serial number ≥ I.

Kræplin internal measuring instruments Intertest

Measuring instruments for accurate and reliable measurements of internal dimensions.

- Measuring range: 10-430 mm.
- Graduation: 0.01, 0.05, 0.2 or 0.1 mm.
- Very fine tolerances on the various parts.
- Impact and shock-resistant housing.
- Dust and drip proof.
- Damped movement of the measuring arm.
- Adjustable tolerance markers.
- Protection: IP65.
- Delivery in a case with an inspection report.



854.924

NEW



Item No.	Meas. range mm	Graduation mm	Accuracy mm	Repeatability mm	Price EUR
854.924	10- 30	0.01	±0.03	0.01	355.40
854.925	20- 40	0.01	±0.03	0.01	355.40
854.926	30- 50	0.01	±0.03	0.01	355.40
854.927	40- 60	0.01	±0.03	0.01	355.40
854.928	50- 70	0.01	±0.03	0.01	355.40
854.929	60- 80	0.01	±0.03	0.01	355.40
854.930	70- 90	0.01	±0.03	0.01	355.40
854.931	80-100	0.01	±0.03	0.01	355.40
854.019	15- 65	0.05	±0.05	0.025	409.10
854.020	40- 90	0.05	±0.05	0.025	409.10
854.021	70-120	0.05	±0.05	0.025	471.30
854.022	100-150	0.05	±0.05	0.025	471.30
854.023	130-180	0.05	±0.05	0.025	471.30
854.024	150-200	0.05	±0.05	0.025	505.60
854.227	50-150	0.1	±0.15	0.1	772.00
854.228	70-170	0.1	±0.15	0.1	772.00
854.361	80-180	0.1	±0.25	0.1	953.40
854.360	150-250	0.1	±0.3	0.1	953.40
854.362	200-400	0.2	±0.4	0.2	1,023.20

Item No.	Meas. range mm	Graduation mm	Accuracy mm	Repeatability mm	Price EUR
854.932	50-100	0.01	±0.03	0.015	542.70
854.933	90-140	0.01	±0.03	0.015	542.70
854.957	130-180	0.01	±0.03	0.015	582.30
854.025	180-310	0.05	±0.075	0.05	624.70
854.026	300-430	0.05	±0.15	0.075	670.50

Types of inserts

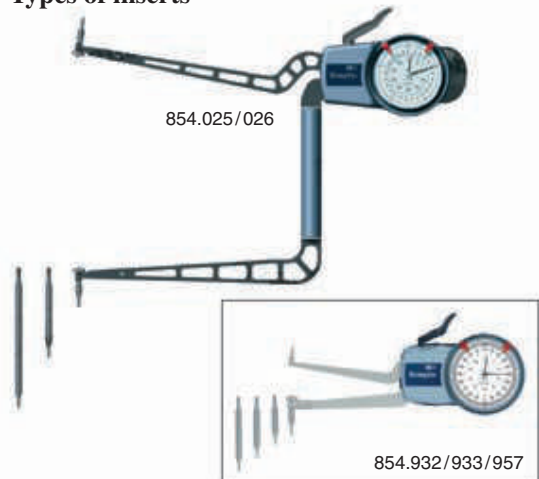

For specifications refer to the Kræplin internal measuring instruments overview.

Overview Kroeplin internal measuring instruments

Item No.	Measuring range mm	Meas. depth L/mm	Groove depth A/mm	Groove width B/mm	Type of insert	Insert length/mm Hb Hf	
Digital internal measuring instruments:							
854.913	2.5 - 12.5	12	0.7	0.5	① R0.1	0.9	0.9
854.914	5 - 15	35	2.3	0.8	② $\varnothing 0.6$	2.5	2.5
854.915	10 - 30	85	5.2	1.2	② $\varnothing 1$	5.3	5.3
854.916	20 - 40	85	7	1.2	② $\varnothing 1$	7.3	7.3
854.917	30 - 50	85	7	1.2	② $\varnothing 1$	7.3	7.3
854.918	40 - 60	85	8.3	1.2	③ $\varnothing 1$	8.5	8.5
854.919	50 - 70	85	8.3	1.2	③ $\varnothing 1$	8.5	8.5
854.920	60 - 80	85	8.3	1.2	③ $\varnothing 1$	8.5	8.5
854.921	70 - 90	85	8.3	1.2	③ $\varnothing 1$	8.5	8.5
854.960	80 - 100	85	8.3	1.2	③ $\varnothing 1$	8.5	8.5
854.012	13 - 43	127	5.5	1.8	② $\varnothing 1.3$	5.9	5.9
854.013	30 - 60	127	6.5	2	③ $\varnothing 1.5$	6.5	6.5
854.014	50 - 80	127	8.3	2.3	③ $\varnothing 2$	8.5	8.5
854.015	70 - 100	127	8.3	2.3	③ $\varnothing 2$	8.5	8.5
854.016	90 - 120	127	8.3	2.3	③ $\varnothing 2$	8.5	8.5
854.017	15 - 65	188	6	2	② $\varnothing 1.5$	6	6
854.018	40 - 90	192	8.3	2.3	③ $\varnothing 2$	8.5	8.5
Internal measuring instruments Interest:							
854.922	2.5 - 12.5	12	0.7	0.5	① R0.1	0.9	0.9
854.923	5 - 15	35	2.3	0.8	② $\varnothing 0.6$	2.5	2.5
854.924	10 - 30	85	5.2	1.2	② $\varnothing 1$	5.3	5.3
854.925	20 - 40	85	7	1.2	② $\varnothing 1$	7.3	7.3
854.926	30 - 50	85	7	1.2	② $\varnothing 1$	7.3	7.3
854.927	40 - 60	85	8.3	1.2	③ $\varnothing 1$	8.5	8.5
854.928	50 - 70	85	8.3	1.2	③ $\varnothing 1$	8.5	8.5
854.929	60 - 80	85	8.3	1.2	③ $\varnothing 1$	8.5	8.5
854.930	70 - 90	85	8.3	1.2	③ $\varnothing 1$	8.5	8.5
854.931	80 - 100	85	8.3	1.2	③ $\varnothing 1$	8.5	8.5
854.019	15 - 65	188	5	2	② $\varnothing 1.5$	6.3	6.3
854.020	40 - 90	192	8.3	2.3	③ $\varnothing 2$	8.5	8.5
854.021	70 - 120	192	8.3	2.3	③ $\varnothing 2$	8.5	8.5
854.022	100 - 150	192	8.3	2.3	③ $\varnothing 2$	8.5	8.5
854.023	130 - 180	192	8.3	2.3	③ $\varnothing 2$	8.5	8.5
854.024	150 - 200	192	8.3	2.3	③ $\varnothing 2$	8.5	8.5
854.227	50 - 150	395	2.5	5.5	④ $\varnothing 5$	3	3
854.228	70 - 170	395	12.5	5.5	④ $\varnothing 5$	13	13
854.361	80 - 180	535	11	5.5	④ $\varnothing 5$	12	12
854.360	150 - 250	535	31	5.5	④ $\varnothing 5$	32	32
854.362	200 - 400	735	28	21	⑤ SR20	29	29

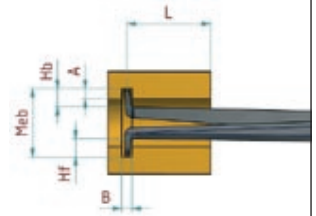

Types of inserts

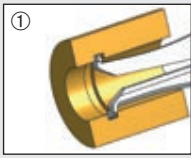

①
R=0.1 mm

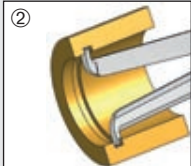

②
TC-ball
 $\varnothing 0.6, 1, 1.3$ or 1.5 mm

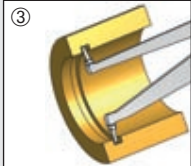

③
TC-ball $\varnothing 1$ or 2 mm

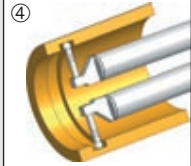

④
 $\varnothing 5$ mm

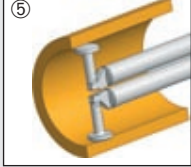

⑤
SR 20 mm

Item No.	Measuring range mm	Number of inserts	Measuring range per insert/mm	Meas. depth L/mm	Type of insert	Insert length/mm Hb Hf	
Internal measuring instruments Interest:							
854.932	50 - 100	4	20	85	③ $\varnothing 1$	12	21/31/41/51
854.933	90 - 140	4	20	85	③ $\varnothing 1$	12	21/31/41/51
854.957	130 - 180	4	20	85	③ $\varnothing 1$	12	21/31/41/51
854.025	180 - 310	3	50	192	③ $\varnothing 2$	20	20/60/100
854.026	300 - 430	3	50	192	③ $\varnothing 2$	21	20/60/100

Krœplin internal measuring instruments Intertest

- Measuring range: 2.5 - 15 mm.
- Graduation: 0.005 mm.
- Adjustable tolerance limits.
- Protection: IP65.
- Delivery in a case with an inspection report.



854.922

Item No.	Measuring range/mm	Graduation mm	Accuracy mm	Repeatability mm	Price EUR
854.922	2.5 - 12.5	0.005	±0.015	0.005	355.40
854.923	5 - 15	0.005	±0.015	0.005	355.40

For specifications refer to the Krœplin internal measuring instruments overview.

Krœplin external measuring instruments Pocotest

A handy universally usable thickness gauge from the Poco line.

- Measuring range: 0 - 10 mm.
- Graduation: 0.1 mm.
- Accuracy: ±0.1 mm.
- Repeatability: 0.05 mm.
- Delivery in a case.

Types of inserts

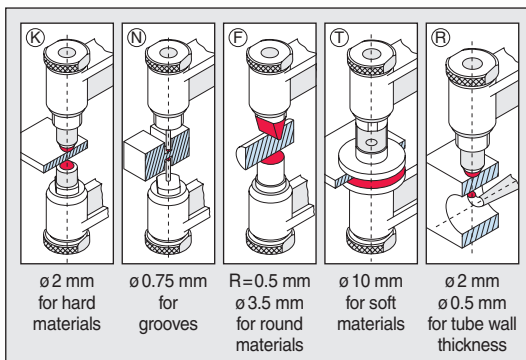

854.001

Item No.	Measuring range/mm	Meas. depth L/mm	Type of insert	Insert length		Price EUR
				Hb	Hf	
854.001	0 - 10	36	K	5	5	100.20
854.002	0 - 10	36	N	3.5	3.5	100.20
854.003	0 - 10	36	F	4.5	4.5	100.20
854.004	0 - 10	36	T	5	5	100.20
854.010	0 - 10	25	R	5	0.5	115.00

Kroëplin digital internal and external measuring instruments

Kroëplin's new generation of quickest measuring instruments has a compact, ergonomic design. The digital-analog display makes read-out easier. Now with wireless rechargeable battery and Bluetooth data interface.

- Measuring range: 0-25 mm.
- Resolution: 0.001, 0.002, 0.005, 0.01 mm.
- mm/inch conversion.
- ABS/INC switchable.
- Mitutoyo Digimatic, Mitutoyo U-WAVE, USB or Bluetooth data outputs optionally available.
- With tolerance display.
- Purpose-built measuring program and measuring inserts.
- Bluetooth: up to 8 gauges simultaneously.
- Protection: IP67.
- Wireless charging.
- Delivery in a case with charging pad and an inspection report.
- Power supply: rechargeable battery.



Item No.	Measuring range/mm	Resolution mm	Accuracy mm	Repeatability mm	Price EUR
Internal measuring instruments:					
854.066	2.5 - 12.5	0.001	±0.01	0.005	365.60
854.067	5 - 20	0.001	±0.01	0.005	365.60
854.068	10 - 25	0.001	±0.01	0.005	365.60
External measuring instruments:					
854.069	0 - 15	0.001	±0.01	0.005	365.60
854.070	0 - 15	0.001	±0.015	0.005	365.60
Options:					
854.071	Digimatic interface				87.00
965.013 ¹	Digimatic cable				60.00
206.380 ¹	USB cable				104.00
102.790 ¹	U-WAVE cable				87.00
854.072 ²	Bluetooth interface adapter				87.00
854.073	Bluetooth PC dongle				8.10
854.074	Wooden box				39.20

¹ For data output the Digimatic interface and cable are needed.

² Bluetooth interface adapter is delivered with a Bluetooth PC dongle (854.073).

Item No.	Meas. depth L/mm	Groove depth A/mm	Groove width B/mm	Type of insert	Insert length Hb/mm	Insert length Hf/mm
854.066	12	0.7	0.6	① R0.1	0.9	0.9
854.067	44	2.2	0.8	② ø0.6	2.2	2.2
854.068	46	4	1.5	② ø1	4.4	4.4
854.069	45	15	2.5	③ ø1.5	17	17
854.070	45	11	1.5	④ R0.4	12	12

Types of inserts

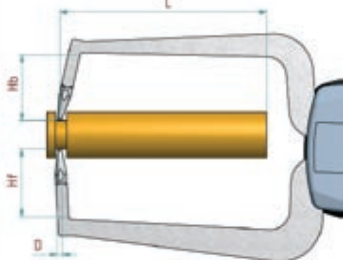
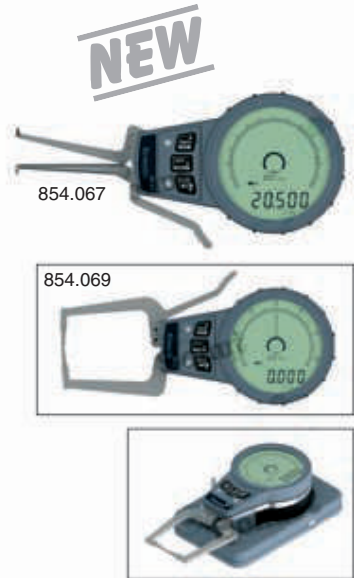
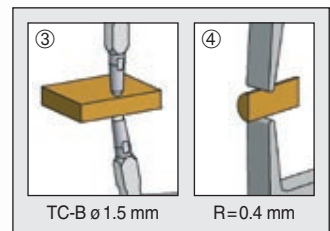
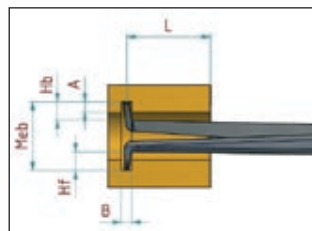
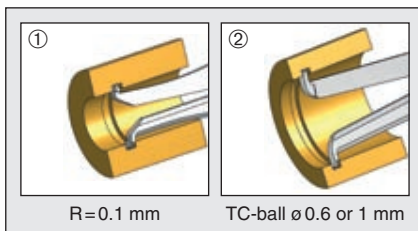

Digital external measuring instruments

Digital external measuring instruments for measurements of external grooves, axis diameters, wall thicknesses and other hard-to-reach places.

- Measuring range: 0-60 mm.
- Resolution: 0.005 mm. Digital-analog display changes automatically between 0.01, 0.02 and 0.05 mm (± 20 scale divisions).
- mm/inch conversion.
- ABS/INC switchable.
- Large LCD display, 340° rotatable.
- On/off switch.
- Automatic switch-off.
- Reset/preset.
- Hold and min/max functions.
- Adjustable tolerance limits.
- Measuring faces with different contact forms.
- Power supply: 1 battery type CR2032.



908.850



Item No.	Measuring range/mm	Accuracy mm	Length/mm			Contact form/mm	Price EUR
			L	A	B		
Travel 10 mm:							
908.850	0-10	± 0.02	40	3	8	① R 0.5	116.00
908.851	10-20	± 0.02	40	3	8	① R 0.5	126.00
908.852	20-30	± 0.02	40	3	8	① R 0.5	126.00
908.853	30-40	± 0.02	40	3	8	① R 0.5	126.00
908.854	40-50	± 0.02	40	3	8	① R 0.5	126.00
908.855	0-10	± 0.02	40	3	8	② $\phi 1.5$	134.00
908.856	10-20	± 0.02	40	3	8	② $\phi 1.5$	145.00
908.857	20-30	± 0.02	40	3	8	② $\phi 1.5$	145.00
908.858	30-40	± 0.02	40	3	8	② $\phi 1.5$	145.00
908.859	40-50	± 0.02	40	3	8	② $\phi 1.5$	145.00
Travel 20 mm:							
908.860	0-20	± 0.03	80	6.5	25	① R 0.75	126.00
908.861	10-30	± 0.03	80	6.5	25	① R 0.75	139.00
908.862	20-40	± 0.03	80	6.5	25	① R 0.75	139.00
908.863	30-50	± 0.03	80	6.5	25	① R 0.75	139.00
908.864	40-60	± 0.03	80	6.5	25	① R 0.75	145.00
908.865	0-20	± 0.03	80	6.5	25	② $\phi 1.5$	145.00
908.866	10-30	± 0.03	80	6.5	25	② $\phi 1.5$	160.00
908.867	20-40	± 0.03	80	6.5	25	② $\phi 1.5$	160.00
908.868	30-50	± 0.03	80	6.5	25	② $\phi 1.5$	160.00
908.869	40-60	± 0.03	80	6.5	25	② $\phi 1.5$	166.00
Option: 495.157 Spare battery							0.50

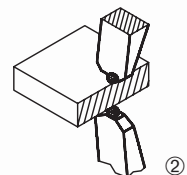
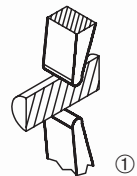
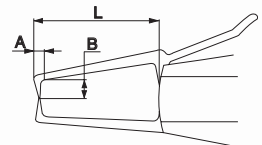

External measuring instruments

External measuring instruments for measurements of external grooves, axis diameters, wall thicknesses and other hard-to-reach places.

- Measuring range: 0- 60 mm.
- Graduation: 0.01 mm.
- Rotatable dial.
- Adjustable tolerance markers.
- Measuring faces with different contact forms.



908.870



Item No.	Measuring range/mm	Accuracy mm	Length/mm			Contact form/mm	Price EUR
			L	A	B		
Travel 10 mm:							
908.870	0- 10	±0.02	40	3	8	① R 0.5	105.00
908.871	10- 20	±0.02	40	3	8	① R 0.5	113.00
908.872	20- 30	±0.02	40	3	8	① R 0.5	113.00
908.873	30- 40	±0.02	40	3	8	① R 0.5	113.00
908.874	40- 50	±0.02	40	3	8	① R 0.5	113.00
908.875	0- 10	±0.02	40	3	8	② ø 1.5	120.00
908.876	10- 20	±0.02	40	3	8	② ø 1.5	130.00
908.877	20- 30	±0.02	40	3	8	② ø 1.5	130.00
908.878	30- 40	±0.02	40	3	8	② ø 1.5	130.00
908.879	40- 50	±0.02	40	3	8	② ø 1.5	130.00
Travel 20 mm:							
908.880	0- 20	±0.03	80	6.5	25	① R 0.75	113.00
908.881	10- 30	±0.03	80	6.5	25	① R 0.75	125.00
908.882	20- 40	±0.03	80	6.5	25	① R 0.75	125.00
908.883	30- 50	±0.03	80	6.5	25	① R 0.75	125.00
908.884	40- 60	±0.03	80	6.5	25	① R 0.75	130.00
908.885	0- 20	±0.03	80	6.5	25	② ø 1.5	130.00
908.886	10- 30	±0.03	80	6.5	25	② ø 1.5	144.00
908.887	20- 40	±0.03	80	6.5	25	② ø 1.5	144.00
908.888	30- 50	±0.03	80	6.5	25	② ø 1.5	144.00
908.889	40- 60	±0.03	80	6.5	25	② ø 1.5	150.00

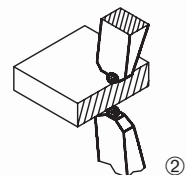
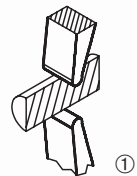
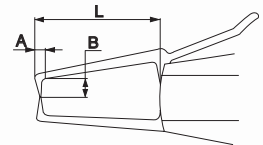

Krœplin digital external measuring instruments

Krœplin's new generation of quickest measuring instruments has a compact, ergonomic design. The digital-analog display makes read-out easier.

- Measuring range: 0- 50 mm.
- Resolution: 0.005, 0.01 or 0.02 mm.
- mm/inch conversion.
- ABS/INC switchable.
- Mitutoyo Digimatic, Mitutoyo U-WAVE and USB data outputs optionally available.
- With tolerance display.
- Purpose-built measuring program and measuring inserts.
- Protection: IP67.
- Delivery in a case with an inspection report.
- Power supply: 2 batteries type AAA.



854.908

Item No.	Measuring range/mm	Resolution mm	Accuracy mm	Repeatability mm	Price EUR
854.905	0- 10	0.005	±0.015	0.005	365.60
854.961	0- 10	0.005	±0.015	0.005	365.60
854.906	0- 10	0.005	±0.02	0.005	365.60
854.907	0- 10	0.005	±0.015	0.005	365.60
854.962	0- 10	0.005	±0.015	0.005	365.60
854.908	0- 20	0.01	±0.03	0.01	365.60
854.963	0- 20	0.01	±0.03	0.01	365.60
854.955	0- 20	0.01	±0.03	0.01	365.60
854.950	0- 20	0.01	±0.03	0.01	365.60
854.956	0- 20	0.01	±0.03	0.01	365.60
854.027	0- 30	0.02	±0.04	0.02	365.60
854.036	0- 30	0.02	±0.04	0.02	365.60
854.029	0- 30	0.02	±0.06	0.04	365.60
854.028	0- 30	0.02	±0.04	0.02	365.60
854.037	0- 30	0.02	±0.04	0.02	365.60
854.030	0- 50	0.02	±0.06	0.04	505.60
854.032	0- 50	0.02	±0.08	0.06	505.60
854.031	0- 50	0.02	±0.06	0.04	505.60

Options:

497.914	Spare battery type AAA	0.40
854.952*	Interface	39.20
965.013*	Digimatic cable	60.00
206.380*	USB cable	104.00
102.790*	U-WAVE cable	87.00

*For data output an interface and cable are needed. Only for new instruments with serial number ≥ I.



854.030



For specifications refer to the Krœplin external measuring instruments overview.

Krœplin external measuring instruments Oditest

External measuring instrument in a version which is highly accurate and reliable.

- Measuring range: 0-200 mm.
- Graduation: 0.005, 0.01, 0.05, 0.1 or 0.2 mm.
- Very fine tolerances on the various parts.
- Impact and shock-resistant housing.
- Dust and drip proof.
- Damped movement of the measuring arm.
- Adjustable tolerance markers.
- Protection: IP65.
- Delivery in a case with an inspection report.



854.934

NEW

For specifications refer to the Krœplin external measuring instruments overview.

Item No.	Meas. range mm	Graduation mm	Accuracy mm	Repeatability mm	Price EUR
854.909	0-10	0.005	±0.015	0.005	355.40
854.910	0-10	0.005	±0.02	0.005	355.40
854.911	0-10	0.005	±0.015	0.005	355.40
854.912	0-10	0.005	±0.015	0.005	355.40
854.934	0-20	0.01	±0.03	0.01	355.40
854.935	0-20	0.01	±0.03	0.01	355.40
854.936	0-20	0.01	±0.04	0.01	355.40
854.937	0-20	0.01	±0.03	0.01	355.40
854.938	0-20	0.01	±0.03	0.01	355.40
854.033	0-50	0.05	±0.05	0.025	409.10
854.034	0-50	0.05	±0.05	0.025	409.10
854.035	0-50	0.05	±0.1	0.025	439.40
854.038	0-50	0.05	±0.05	0.025	409.10
854.039	0-50	0.05	±0.05	0.025	409.10

Item No.	Meas. range mm	Graduation mm	Accuracy mm	Repeatability mm	Price EUR
854.225	0-100	0.1	±0.15	0.1	772.00
854.109	0-100	0.1	±0.15	0.1	772.00
854.226	0-100	0.1	±0.15	0.1	772.00
854.363	0-100	0.1	±0.3	0.15	953.40
854.364	0-100	0.1	±0.3	0.15	1,023.20
854.365	0-100	0.1	±0.4	0.15	1,023.20
854.366	0-200	0.2	±0.4	0.2	1,023.20



Overview Krøplin external measuring instruments

External measuring instruments Oditest

Item No.	Measuring range/mm	Meas. depth L/mm	Type of insert	Insert length Hb	Hf
854.909	0- 10	35	① $\phi 1.5$	19.1	18.6
854.910	0- 10	35	⑦ $\phi 6$	21.7	14.8
854.911	0- 10	35	③ $\phi 1.5$	19.1	0.9
854.912	0- 10	35	④ R0.4	18.8	0.9
854.934	0- 20	85	① $\phi 1.5$	24.7	24.6
854.935	0- 20	85	② R0.4	24.7	24.6
854.936	0- 20	85	⑦ $\phi 10$	28.2	20.7
854.937	0- 20	80	⑤ $\phi 1.5$	24.7	2.5
854.938	0- 20	80	⑥ R0.4	24.7	2.5
854.033	0- 50	167	① $\phi 3$	30	30
854.034	0- 50	167	② R0.75	30	30
854.035	0- 50	167	⑦ $\phi 50$	36	24
854.038	0- 50	167	③ $\phi 3$	30	4.6
854.039	0- 50	167	④ R0.75	30	4.6
854.225	0-100	383	⑧ $\phi 5$	35	35
854.109	0-100	382	⑨ $\phi 5$	35	15
854.226	0-100	382	⑦ $\phi 50$	41	9
854.363	0-100	530	⑧ $\phi 5$	32	32
854.364	0-100	530	⑧ $\phi 5$	32	132
854.365	0-100	555	⑦ $\phi 50$	46	26
854.366	0-200	725	⑩ 20	100	100

Digital external measuring instruments

Item No.	Measuring range/mm	Meas. depth L/mm	Type of insert	Insert length Hb	Hf
854.905	0-10	35	① $\phi 1.5$	19.1	18.6
854.961	0-10	35	② R0.4	18.8	18.5
854.906	0-10	35	⑦ $\phi 6$	21.7	14.8
854.907	0-10	35	③ $\phi 1.5$	19.1	0.9
854.962	0-10	35	④ $\phi 1.5$	18.8	0.9
854.908	0-20	85	① $\phi 1.5$	24.7	24.6
854.963	0-20	81	② R0.4	24.7	24.6
854.955	0-20	81	⑦ $\phi 10$	28.2	20.7
854.950	0-20	80	⑤ $\phi 1.5$	24.7	2.5
854.956	0-20	80	⑥ $\phi 1.5$	24.7	2.5
854.027	0-30	114	① $\phi 3$	30	30
854.036	0-30	116	② R0.75	30	30
854.029	0-30	114	⑦ $\phi 50$	36	24
854.028	0-30	116	⑤ $\phi 3$	30	4.6
854.037	0-30	116	⑥ $\phi 3$	30	4.6
854.030	0-50	167	① $\phi 3$	30	30
854.032	0-50	167	⑦ $\phi 50$	36	24
854.031	0-50	167	⑤ $\phi 3$	30	4.6

NEW

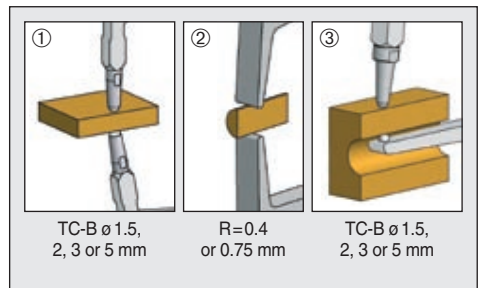
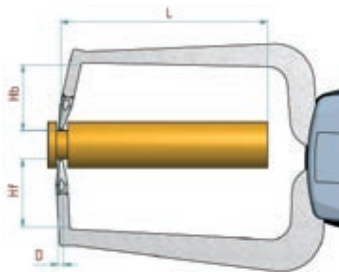

Types of inserts

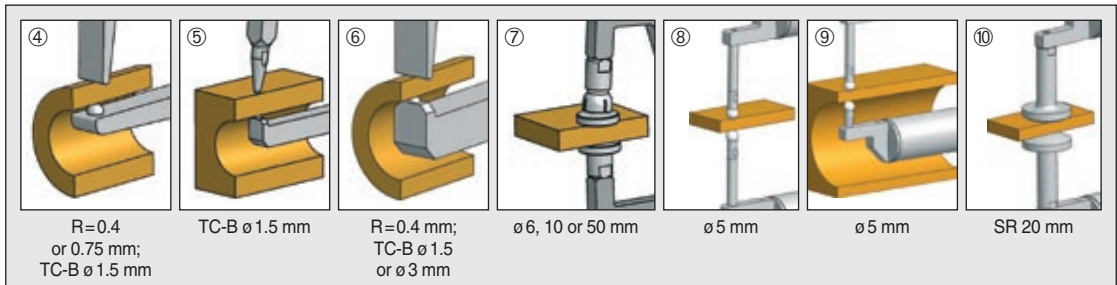

Digital thickness gauge

This digital thickness gauge has special, pointed measuring faces for measuring in hard-to-reach places of metal parts.

- Measuring range: 0- 15 mm.
- Resolution: 0.01 mm.
- Accuracy: ± 0.03 mm.
- mm/inch conversion.
- On/off switch.
- Reset.
- Weight: 100 g.
- Power supply:
1 battery type V357.

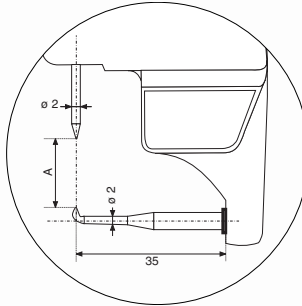

Item No.	Measuring face	Throat depth/mm	Price EUR
906.450	Pointed	35	83.00
Option:			
836.535	Spare battery		1.90



Digital thickness gauges

The shape of the measuring faces makes this digital thickness gauge especially suitable for measuring metal or plastic film, leather, paper, etc.

- Measuring range: 0- 25 mm.
- Resolution: 0.01 mm.
- Accuracy:
0- 15 mm: ± 0.03 mm,
0- 25 mm: ± 0.04 mm.
- mm/inch conversion.
- On/off switch.
- Reset.
- Weight: 100 g.
- Power supply: 1 battery type V357.

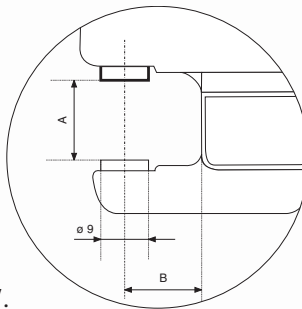

906.451

Item No.	Measuring range/mm	Measuring face ϕ /mm	Throat depth/mm	Price EUR
906.451	0- 15	9	15.0	79.00
906.452	0- 25	9	14.5	107.00
Option:				
836.535	Spare battery			1.90

Digital external measuring instruments

- Measuring range: 0- 10 mm.
- Resolution: 0.01 mm.
- Repeatability: 0.01 mm.
- mm/inch conversion.
- Automatic switch-off.
- Reset.
- Max. measuring speed: 1.5 m/s.
- Non-interchangeable inserts.
- Power supply: 1 battery type V357.



906.454

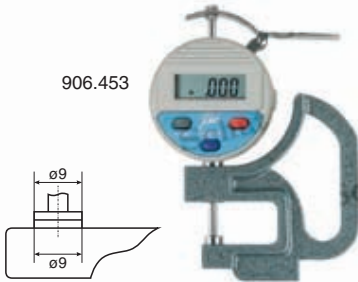

906.453

Item No.	Measuring range/mm	Measuring faces ϕ /mm	Throat depth/mm	Price EUR
906.453	0- 10	9	30	92.00
906.454	0- 10	9	120	115.00
Option:				
836.535	Spare battery			1.90

Käfer digital external measuring instruments 0.01 and 0.001 mm

Fast thickness measurement of small parts and sheet and foil material.

- Measuring range: 0- 25 mm.
- Resolution: 0.01 mm or 0.001 mm.
- mm/inch conversion.
- USB/RS232C data output.
- On/off switch.
- Reset/preset.
- Hold function.
- Interchangeable measuring inserts.
- Measuring faces standard type of insert: ϕ 10 mm.
- Different types of inserts available.
- Power supply: 1 battery type CR2032.



NEW

852.741



852.715

Item No.	Measuring range/mm	Resolution mm	Accuracy mm	Throat depth/mm	Price EUR
852.768	0- 10	0.01	± 0.01	50	423.00
852.715	0- 25	0.01	± 0.01	50	490.00
852.754	0- 25	0.01	± 0.01	100	524.00
852.396	0- 10	0.001	± 0.005	50	472.00
852.741	0- 25	0.001	± 0.005	200	630.00
Options:					
495.157	Spare battery				0.50
852.117	RS232C cable 9p (2 m)				121.00
852.118	USB cable (2 m)				121.00

Thickness gauges

- Measuring range: 0-20 mm.
- Graduation: 0.01 mm.
- Rotatable dial.
- Non-interchangeable inserts.
- Measuring face: \varnothing 10 mm (906.446: \varnothing 6 mm).



906.446



906.447



906.448



Item No.	Measuring range/mm	Throat depth/mm	Price EUR
906.446	0-10	10	37.60
906.447	0-10	30	54.00
906.448	0-20	110	81.00

Thickness gauges with roller measuring inserts

- Measuring range: 0-10 mm.
- Measuring face: 7 mm/ \varnothing 22 mm.
- Throat depth: 100 mm.
- Anvil: 28 x 22 mm (3 mm wheel height in anvil).

Analog

- Graduation: 0.01 mm.
- Rotatable dial with locking screw.
- Adjustable tolerance markers.

Digital

- Resolution: 0.01 mm.
- mm/inch conversion.
- On/off switch.
- Reset.
- Power supply: 1 battery type CR2032.



906.388

NEW



906.389

Item No.	Description	Price EUR
906.388	Thickness gauge	88.00
906.389	Digital thickness gauge	124.00
Option:		
495.157	Spare battery	0.50

Peacock external measuring instruments

- Measuring range: 0 - 10 mm.
- Graduation: 0.01 mm.
- Measuring force: approx. 1.8 N.
- Non-interchangeable measuring inserts.
- Ceramic measuring faces.



855.750



855.751

Item No.	Measuring range/mm	Measuring faces ϕ /mm	Throat depth/mm	Price EUR
855.750	0 - 10	10	20	49.00
855.751	0 - 10	10	120	55.00

External measuring instruments

- Measuring range: 0 - 10 mm.
- Graduation: 0.01 mm.
- Different types of inserts available, with hardened steel measuring faces.
- Throat depth: 50 mm.

Item No.	Type of insert	Price EUR
853.002	B	141.00
853.003	C	141.00
853.004	D	141.00
853.005	E	141.00
853.007	G	141.00







853.007

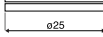

853.002

Types of inserts

-  **B** Wood, rubber, soft leather
-  **C** Soft rubber
-  **D** Rubber rings, round material
-  **E** Paper, cardboard, fibrous plates
-  **G** Metal

Thickness gauge for film measurement

- Measuring range: 0 - 1 mm.
- Graduation: 0.001 mm.
- Measuring force: approx. 3 N.
- Non-interchangeable measuring inserts.
- Throat depth: 25 mm.
- Frame with insulating grip.

- Delivery with an inspection report.

Item No.	Measuring range/mm	Meas. faces ϕ /mm	Price EUR
907.859	0 - 1	10	96.00



Interapid thickness gauge for film measurement



- Measuring range: 0 - 1 mm.
- Graduation: 0.001 mm.
- Measuring force: approx. 2 N.
- Non-interchangeable measuring inserts.
- Throat depth: 30 mm.
- Frame with insulating grip.
- Delivery with a declaration of conformity.

Item No.	Measuring range/mm	Meas. faces ϕ /mm	Price EUR
781.547	0 - 1	6.35	392.00

Peacock universal thickness gauge

Measuring instrument with dial indicator and adjustable anvil, multi-purpose.

- Span frame: 0 - 20 mm.
- Measuring range dial indicator: 10 mm.
- Graduation: 0.01 mm.
- Throat depth: 25 mm.
- With additional flat insert.

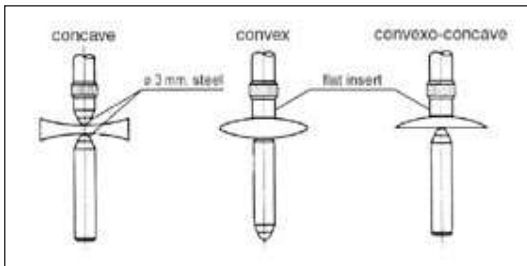

Item No.	Measuring range dial indicator/mm	Price EUR
855.752	0 - 10	61.00

Tube wall thickness gauge



- Measuring range: 0 - 10 mm.
- Graduation: 0.01 mm.
- Measuring force: approx. 1 N.
- Throat depth: 25 mm.
- From inner diameter 8 mm.

Item No.	Measuring range/mm	Price EUR
853.137	0 - 10	96.00

Thickness gauges

- Measuring range: 0 - 50 mm.
- Graduation: 0.1 mm.
- Different types of inserts.
- Hardened steel measuring faces.
- Other models available on request.



853.064



853.033



853.045



853.022



Types of inserts

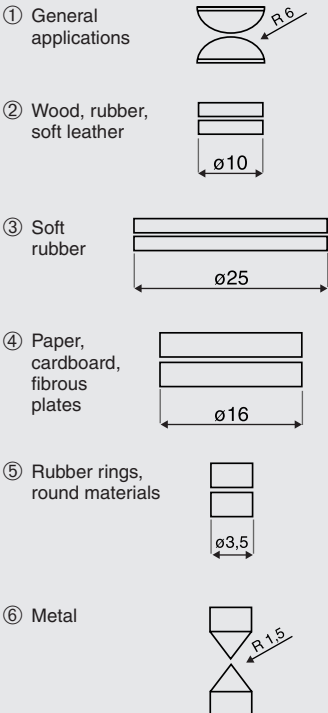

Item No.	Measuring range/mm	Type of insert	Throat depth/mm	Price EUR
853.022	0 - 10	②	15	38.80
853.031	0 - 30	⑤	50	45.00
853.032	0 - 30	②	50	45.00
853.033	0 - 30	③	50	45.00
853.034	0 - 30	④	50	45.00
853.035	0 - 30	⑥	50	45.00
853.037	0 - 30	①	50	51.00
853.041	0 - 50	⑤	50	48.00
853.042	0 - 50	②	50	48.00
853.043	0 - 50	③	50	48.00
853.044	0 - 50	④	50	48.00
853.045	0 - 50	⑥	50	48.00
853.047	0 - 50	①	50	54.00
853.052	0 - 25	②	150	81.00
853.053	0 - 25	③	150	81.00
853.054	0 - 25	①	150	87.00
853.055	0 - 25	④	150	81.00
853.056	0 - 25	⑥	150	81.00
853.062	0 - 25	②	300	88.00
853.063	0 - 25	③	300	88.00
853.064	0 - 25	①	300	93.00
853.065	0 - 25	④	300	88.00
853.066	0 - 25	⑥	300	88.00
853.082	0 - 25	②	500	116.00
853.083	0 - 25	③	500	116.00
853.084	0 - 25	①	500	121.00
853.085	0 - 25	④	500	116.00
853.087	0 - 25	⑥	500	116.00

Digital external measuring instruments

- Measuring range: 0-25 mm.
- Resolution: 0.01 mm.
- mm/inch conversion.
- On/off switch.
- Reset.
- Different types of inserts.
- Hardened steel measuring faces.
- Other models available on request.







853.074

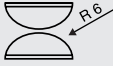

853.060

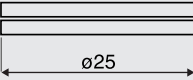
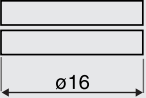
Types of inserts

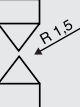
- ① General applications 
- ② Wood, rubber, soft leather 
- ③ Soft rubber 
- ④ Paper, cardboard, fibrous plates 
- ⑤ Rubber rings, round materials 
- ⑥ Metal 

NEW



Item No.	Measuring range/mm	Type of insert	Throat depth/mm	Price EUR
853.072	0-25	①	50	234.00
853.073	0-25	②	50	229.00
853.074	0-25	③	50	229.00
853.075	0-25	④	50	229.00
853.076	0-25	⑤	50	229.00
853.077	0-25	⑥	50	229.00
853.057	0-25	①	200	264.00
853.078	0-25	②	200	259.00
853.079	0-25	③	200	259.00
853.080	0-25	④	200	259.00
853.081	0-25	⑥	200	259.00
853.060	0-25	①	300	280.00
853.091	0-25	②	300	275.00
853.092	0-25	③	300	275.00
853.093	0-25	④	300	275.00
853.094	0-25	⑥	300	275.00

Universal measuring instruments

Robust universal measuring instruments for measuring by comparison, consisting of a steel precision cylinder with one fixed (adjustable) and one mobile measuring arm holder. The measuring direction is reversible by a simple turn of the adjusting screw at the end of the instruments. This feature enables measurements of internal and external dimensions. Clamping shaft 8H7 for dial indicator or measuring probe (measuring range 0-10 mm) not included. The nominal size is set with gauge blocks, setting rings or something similar.

Base instrument, with wooden case

Item No.	Type	Measuring range (internal/external) in mm, with:				Price EUR
		Spherical disc inserts	Spherical needle insert $\varnothing 2 \times 5$ mm	Ball insert $\varnothing 3$ mm	Measuring disc $\varnothing 15 \times 4$ mm	
856.340	2-MR	29-254/9-234	38-263/0-225	36-261/2-227	46-256/16-226	2,820.00
856.341	2L-MR	29-354/9-334	38-363/0-325	36-361/2-327	46-356/16-326	3,000.00
856.342	2EL-MR	29-454/9-434	38-463/0-425	36-461/2-427	46-456/16-426	3,270.00



Measuring arms

Item No.	Length mm	Price EUR per piece
Type MA, with $\varnothing 3.5$ mm bore for interchangeable inserts:		
856.343	25	179.00
856.344	50	179.00
856.345	75	225.00
856.346	100	225.00
Type MB, with internal thread M6 for interchangeable measuring disc:		
856.347	30	179.00
856.348	50	225.00
Type MC, with bore 4H7 for various interchangeable inserts:		
856.349	30	179.00
856.350	50	225.00

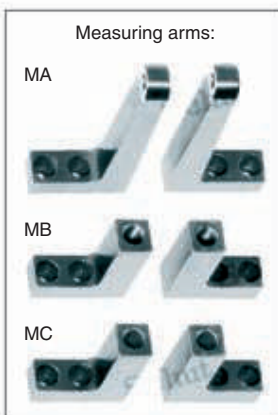

Internal measuring instruments (type I) and external measuring instruments (type O) with non-exchangeable measuring jaws are available on request. Excl. dial indicator or measuring probe.



Universal measuring instruments (continued)

Interchangeable inserts for type MA

Item No.	Description	Price EUR per piece
856.351	Spherical disc insert	118.00
856.372	Flat disc insert	177.00
856.352	Spherical needle ø2 x 5 mm	152.00
856.376	Ditto, ø2 x 25 mm	207.00
856.353	Ball insert ø3 mm	195.00



856.351:
measuring
of bores

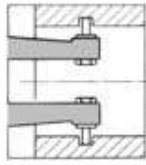

856.352:
measuring
of narrow
grooves

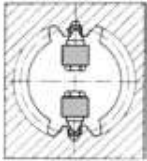

856.353: measuring
of internal gear teeth,
V-grooves, etc.



Available on request: inserts for thread pitch diameters (metric: pitch 0.5 - 7.0; BSW: 14 - 3.0 t.p.i.; UN: 32 - 3.0 t.p.i.). The measuring anvils rotate to follow the helix of the thread.

Interchangeable measuring disc for type MB

A measuring disc, which can be fitted by means of spacers and a support washer, is available for measuring arms MB with internal thread M6. For measuring of shoulders at different levels, locating flanges, etc.

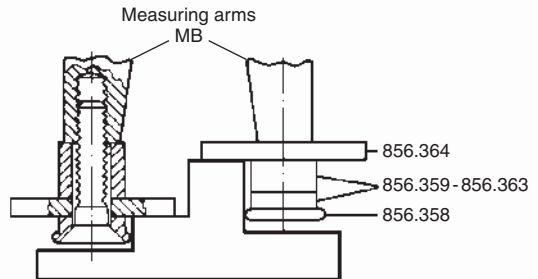

Item No.	Description	Price EUR per piece
856.358	Measuring disc ø15 x 4 mm	114.00
856.359	Spacer 1 mm	37.70
856.360	Spacer 2 mm	37.70
856.361	Spacer 3 mm	37.70
856.362	Spacer 6 mm	37.70
856.363	Spacer 10 mm	37.70
856.364	Support washer ø30 x 3 mm	50.00

Example of a complete instrument with measuring arms type MB, measuring discs and a dial indicator.

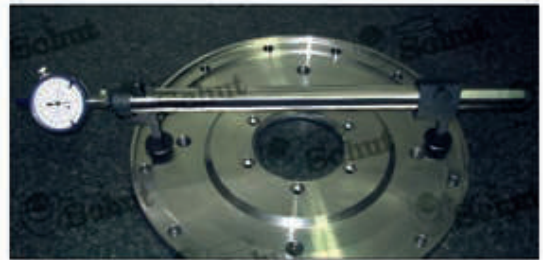

Extensions and connecting elements

Item No.	Description	Price EUR
856.354	Extension 300 mm	361.00
856.355	Extension 500 mm	591.00
856.356	Connecting element for measuring element and extension	336.00
856.357	End cover for extension	50.00

Before placing the extension the measuring direction has to be determined with the adjusting screw.

HELIOS-PREISSER universal gauge

Universal measuring instrument consisting of a steel tube with two mobile measuring arms. The measuring direction is reversible, which enables measurements of internal and external dimensions.

- Measuring range:
 - external measurements: 5 - 220 mm,
 - internal measurements: 15 - 250 mm.
- Measuring range with optional extensions: up to 2000 mm.
- Clamping shaft: $\varnothing 8$ mm.
- Reversible measuring direction.
- Large choice of measuring probes and inserts.
- Inserts also for internal and external screw thread measurements available.
- Basic instrument: excl. dial indicator, measuring probes and inserts.
- Delivery in a case.

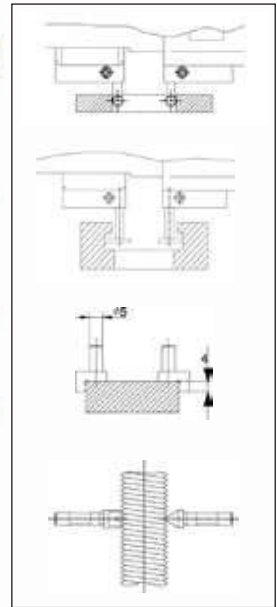

Illustrated:
basic instrument,
measuring arms,
ball inserts, extension
and dial indicator.

Item No.	Description	Price EUR
856.380	Basic instrument	1,787.00
856.319	Ball inserts (pair) $l=23$ mm	110.00
856.339	Measuring arms (pair) $l=80$ mm	311.00

Internal micrometer

Universal internal micrometer of stainless steel and aluminum with a measuring range up to 2000 mm using optional extensions.

- Measuring range: 250 - 350 mm
(2000 mm with extensions).
- Measuring range digital measuring unit:
100 mm.
- Resolution: 0.01 mm.
- Accuracy: ± 0.01 mm.
- mm/inch conversion.
- RS232C data output.
- On/off switch.
- Measuring base delivered with 2 spring accessories.
- Delivery in a case with an inspection report.
- Power supply: 1 battery type CR2032.

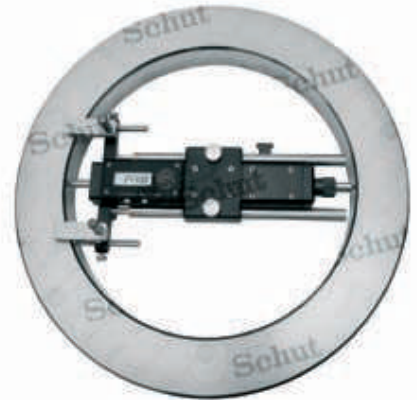

Extensions

Item No.	Description	Price EUR
838.721	Internal micrometer 250 - 350 mm	1,667.00
Option:		
495.157	Spare battery	0.50

Item No.	Extension mm	Price EUR
838.722	50	96.00
838.723	100	141.00
838.724	200	212.00
838.725	300	323.00
838.726	400	485.00

TESA Unimaster

By reversal of the measuring direction, this universal measuring instrument can be used for both internal and external measurements. Specially for large dimensions.

- Measuring range: internal: 250 - 1475 mm,
external: 225 - 1450 mm,
larger ranges are possible (see options).
- Graduation micrometer: 0.01 mm.
- Measuring range dial indicator: ± 0.4 mm.
- Graduation dial indicator: 0.01 mm.
- Accuracy: ± 0.005 mm.
- Interchangeable measuring inserts.
- Tungsten carbide measuring faces.
- Extensions with gauge block accuracy
DIN 861/2.
- External diameter of extensions: 38 mm.
- Connection of extensions through quick
coupling system.
- DIN 863 T4.
- Delivery in a case with a declaration of
conformity.



Item No.	Description	Price EUR
779.799	Unimaster set	
Options:		
779.879	Pair of measuring bolts for internal/external dimensions and grooves, tungsten carbide inserts $\phi 4 \times 7$ mm	
779.809	Extension 1000 mm	
779.875	Support roller (per roller, 2 are needed)	

TESA Inotest

The TESA Inotest is especially suitable for measuring large internal and external dimensions by comparison. The measuring direction changes from internal to external and vice versa, when adjusting the dial indicator. The telescopic extensions can be adjusted to the desired length.

- Measuring range: internal: 275 - 1025 mm,
external: 250 - 1010 mm,
larger ranges are possible.
- Measuring range dial indicator: 10 mm.
- Graduation dial indicator: 0.01 mm.
- Interchangeable measuring inserts.
- Tungsten carbide measuring faces.
- External diameter of extensions:
steel tube 25 mm; telescopic tube 19 mm.
- DIN 863 T4.
- Delivery with a declaration of conformity and
dial indicator with an inspection report.



Item No.	Description	Price EUR
779.824	Inotest set	
Options:		
779.879	Pair of measuring bolts for internal/external dimensions, tungsten carbide inserts $\phi 4 \times 7$ mm	
779.868	Extension 500 mm	
779.869	Extension 1000 mm	
779.878	Measuring device for small dimensions (internal: 35 - 280 mm, external: 15 - 255 mm)	

**Dial indicators / Dial test indicators / Center instruments
Edge finders / Probes / MF measuring fixture system**

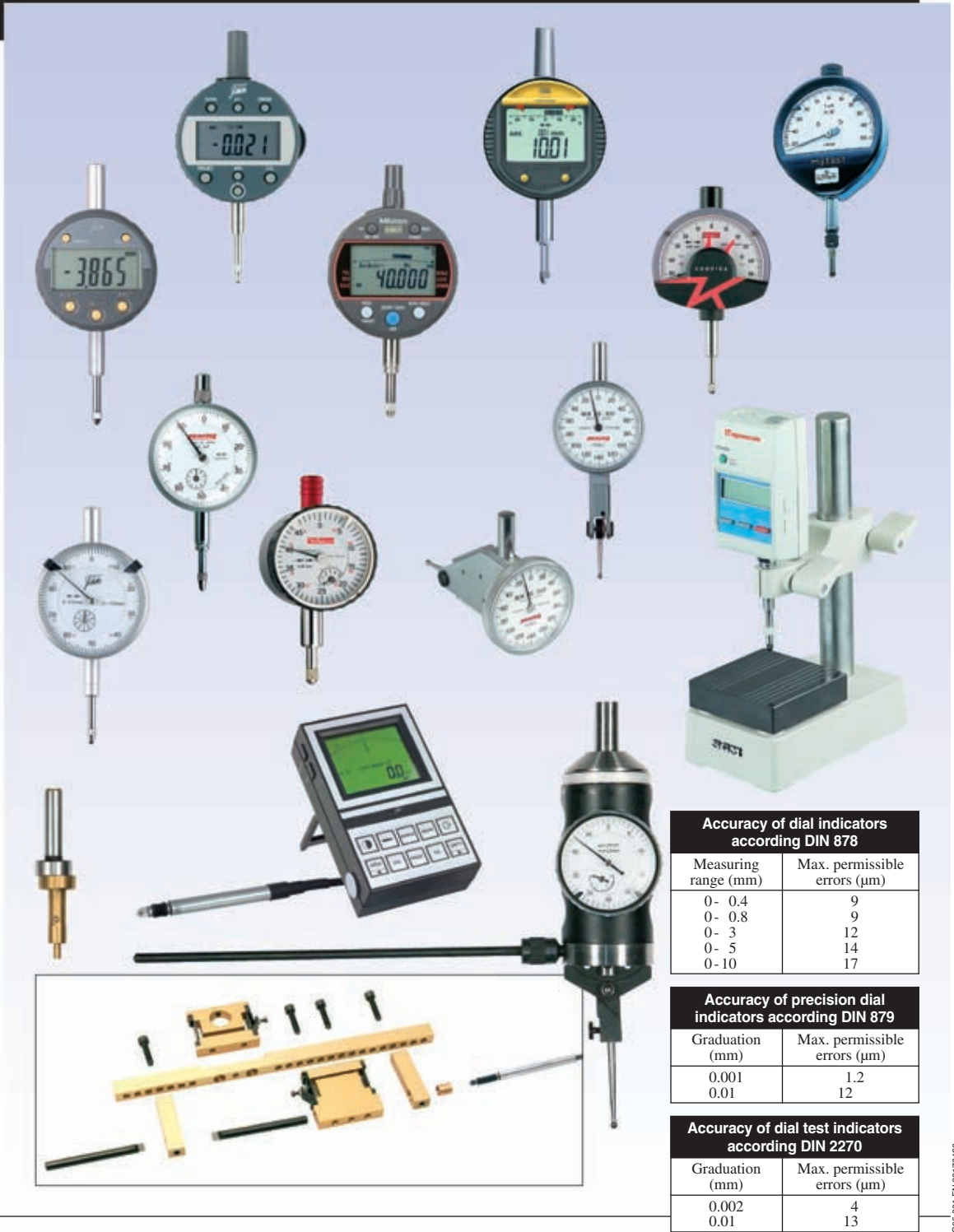

Accuracy of dial indicators according DIN 878	
Measuring range (mm)	Max. permissible errors (µm)
0- 0.4	9
0- 0.8	9
0- 3	12
0- 5	14
0-10	17

Accuracy of precision dial indicators according DIN 879	
Graduation (mm)	Max. permissible errors (µm)
0.001	1.2
0.01	12

Accuracy of dial test indicators according DIN 2270	
Graduation (mm)	Max. permissible errors (µm)
0.002	4
0.01	13

CG5.001-EN-20170420

Digital dial indicators 0.01 and 0.001 mm

Digital dial indicators for a favourable price.

- Measuring range: 0-50 mm.
- Resolution: 0.01 or 0.001 mm.
- mm/inch conversion.
- ABS/INC switchable.
- On/off switch.
- Reset.
- Clamping stem: \varnothing 8 mm.
- Dial diameter: 57 mm.
- Adjustable tolerance limits.
- Flat back and additional back with lug.
- Delivery with an inspection report.
- Power supply: 1 battery type CR2025.



907.646



907.649



Item No.	Measuring range/mm	Accuracy mm	Price EUR
With resolution 0.01 mm:			
907.634	0-12.5	± 0.02	50.00
907.649	0-25	± 0.03	72.00
907.652	0-50	± 0.04	134.00
With resolution 0.001 mm:			
907.646	0-12.5	± 0.015	62.00
Options:			
495.214	Spare battery		0.70
909.446	USB interface		120.00
909.687	Foot switch		17.30



909.446

USB interface:

- For data transfer to PC (e.g. Excel, Word).
- Operating system: Windows and other.
- PC connection: USB data output (cable length 2 m).
- No software or driver to install.
- Foot switch (optional).

Absolute digital dial indicators

- Measuring range: 0 - 50.8 mm.
- Resolution: 0.01 mm or 0.001 mm.
- mm/inch conversion.
- ABS/INC switchable.
- LCD display 330° rotatable.
- Digimatic data output.
- On/off switch.
- Reset/preset.
- Ceramic stylus tip.
- Max. measuring speed: any.
- Measuring force: ≤ 2 N.
- Clamping stem: ø 8 mm.
- Dial diameter: 60 mm.
- Reversible measuring direction.
- With determination of the reversal point (only 910.004).
- Adjustable tolerance limits (except 910.004).
- Flat back.



- With additional back with lug (only 909.998, 910.001/004).
- Protection: IP54.
- Delivery in a case with an inspection report.
- Power supply: 1 battery type CR2032.



NEW

PRICE



909.686



909.687



910.039/038

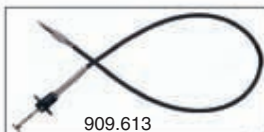

909.613



909.614

Item No.	Measuring range/mm	Resolution mm	Accuracy mm	Price EUR
909.998	0 - 12.7	0.001	±0.004	140.00
909.999	0 - 25.4	0.001	±0.005	183.00
910.000	0 - 50.8	0.001	±0.006	253.00
910.001	0 - 12.7	0.01	±0.01	78.00
910.002	0 - 25.4	0.01	±0.01	100.00
910.003	0 - 50.8	0.01	±0.015	140.00
For internal measurements:				
910.004	0 - 12.7	0.001	±0.004	153.00
With Bluetooth:				
910.079	0 - 12.7	0.001	±0.004	150.00
910.082	0 - 12.7	0.01	±0.01	93.00
Options:				
495.157	Spare battery			0.50
909.686	USB interface			101.00
909.687	Footswitch for USB interface			17.30
910.038	Wireless USB receiver			47.00
910.039	Wireless sender			47.00
909.611	Retraction lever			1.00
909.613	Cable retraction device (1 m) (maximum travel 10 mm)			13.60
909.614	Retraction lever (maximum travel 12.7 mm)			6.00

Digital dial indicators

Digital dial indicators with digital and digital-analog read-out.

- Measuring range: 0- 12.5 mm.
- Resolution: 0.002 or 0.001 mm.
- mm/inch conversion.
- ABS/INC switchable.
- On/off switch.
- Automatic switch-off.
- Reset/preset.
- Clamping stem: \varnothing 8 mm.
- Dial diameter: 62 mm.
- Dial 360° rotatable.
- Reversible measuring direction.
- With determination of the reversal point.
- Adjustable tolerance limits.
- Power supply: 1 battery type CR2032.



909.251

Item No.	Measuring range/mm	Resolution mm	Accuracy mm	Measuring force/N	Price EUR
909.250	0-12.5	0.002	± 0.015	1.8-3.0	92.00
909.251	0-12.5	0.001	± 0.006	2.2-3.5	206.00
Option:					
495.157	Spare battery				0.50

Digital dial indicators

Universal digital indicators with both digital and digital-analog display of the measuring value, and can also be rotated over 340° to ensure easy read-out in all positions.

- Measuring range: 0- 12.7 mm.
- Resolution: 0.001 mm.
- Analog resolution: 0.001/0.002/0.01/0.02/0.05 mm.
- mm/inch conversion.
- ABS/INC switchable.
- On/off switch.
- Automatic switch-off.
- Reset/preset.
- Clamping stem: \varnothing 8 mm.
- Dial diameter: 61 mm.
- Dial 340° rotatable.
- Reversible measuring direction.
- Adjustable tolerance limits.
- Protection: IP54.
- Power supply: 1 battery type CR2032.



907.879

Item No.	Measuring range/mm	Accuracy mm	Price EUR
907.879	0-12.7	± 0.01	106.00
907.878	0-12.7	± 0.005	163.00
Option:			
495.157	Spare battery		0.50



Absolute horizontal digital dial indicators

- Measuring range: 0-30 mm.
- Resolution: 0.001 mm.
- mm/inch conversion.
- Digimatic data output.
- On/off switch.
- Reset/preset.
- Ceramic stylus tip.
- With dovetail joint (incl. lug) and clamping stem \varnothing 8 mm.

- Measuring force: ≤ 2 N.
- Reversible measuring direction.
- Protection: IP54.
- Delivery in a case with an inspection report.
- Power supply: 1 battery type CR1632.

USB interface and wireless USB receiver and sender available on request.



NEW

 **Schut**

Item No.	Measuring range/mm	Resolution mm	Accuracy mm	Price EUR
910.085	0-12.7	0.001	± 0.005	87.00
910.086	0-30	0.001	± 0.006	106.00
Option:				
497.955	Spare battery			1.20

PRICE

Digital dial indicator with calculation function

Robust digital dial indicator with built-in calculation function for easy determination of diameters by means of measuring a curved surface. Suitable for measuring both inside and outside diameters and multifunctional dial indicator applications. Delivery with measuring bases of 10, 20, 30, 60 and 100 mm.

- Measuring range: 0-13 mm.
- Resolution: 0.005 mm.
- mm/inch conversion.
- On/off switch.
- Reset.

- Hold function.
- Clamping stem: \varnothing 8 mm.
- Aluminum construction.
- Delivery in a case.
- Power supply: 1 battery type CR2032.

Item No.	Measuring range/mm	Accuracy mm	Price EUR
907.884	0-13	$\pm 0.005^*$	255.00
Option:			
495.157	Spare battery		0.50

* Accuracy of the indicator without the use of measuring bases. The accuracy with measuring bases depends on the radius and form deviation of the workpiece.



Mitutoyo Absolute Digimatic dial indicators ID-S / ID-S Solar

Standard digital dial indicators with the absolute measuring system with a very good price-performance ratio.

- Measuring range: 0- 12.7 mm.
- Resolution: 0.01 or 0.001 mm.
- Digimatic data output.
- Max. measuring speed: any.
- Measuring force:
543.781/790: ≤ 2.0 N,
543.500/505: ≤ 1.5 N.
- Clamping stem: $\varnothing 8$ mm.
- Tungsten carbide stylus tip.
- Reversible measuring direction.
- Protection: IP42.
- Conforms to factory standard.
- Power supply: 1 battery type V357 (543.781/790).

Item No.	Measuring range/mm	Resolution mm	Accuracy mm	Price EUR
543.781	0- 12.7	0.01	± 0.02	146.00
543.790	0- 12.7	0.001	± 0.003	299.00
ID-S Solar:				
543.505	0- 12.7	0.01	± 0.02	151.00
543.500	0- 12.7	0.001	± 0.003	301.00
Option:				
836.535	Spare battery			1.90



Data cables Digimatic, USB Input Tool Direct, U-WAVE available on request.

Mitutoyo Absolute Digimatic dial indicator 0.01 mm ID-U

Dial indicator from Mitutoyo that combines the absolute system with a measuring range of 25.4 mm.

- Measuring range: 0- 25.4 mm.
- Resolution: 0.01 mm.
- Digimatic data output.
- On/off switch.
- Reset.
- Max. measuring speed: any.
- Measuring force: ≤ 1.8 N.
- Clamping stem: $\varnothing 8$ mm.
- Tungsten carbide stylus tip.
- Reversible measuring direction.
- Dimensions: 207.3 x 38 x 23 mm.
- Protection: IP42.
- Conforms to factory standard.
- Power supply: 1 battery type V357.

Item No.	Measuring range/mm	Accuracy mm	Price EUR
575.121	0-25.4	± 0.02	204.00
Options:			
836.535	Spare battery		1.90
540.774	Lift lever (12 mm)		28.00



Data cables Digimatic, USB Input Tool Direct, U-WAVE available on request.

Mitutoyo Absolute Digimatic dial indicators ID-C

Digital dial indicators with the absolute measuring system and a large display for easy reading of the measuring values and the tolerance judgement. The tolerance values are shown graphically above the current measurement or the graphical display is visible on the entire display. The 330° rotatable display guarantees an ideal read-out in any position.

- Measuring range: 0-50.8 mm.
- Resolution: 0.01 or 0.001 mm.
- ABS/INC switchable (except 543.310).
- LCD display 330° rotatable.
- Digimatic data output.
- Reset/preset.
- Max. measuring speed: any.
- Clamping stem: $\varnothing 8$ mm.

- Tungsten carbide stylus tip.
- Reversible measuring direction (except 543.310).
- Adjustable tolerance limits.
- Protection: IP42.
- Conforms to factory standard.
- Power supply: 1 or 2 batteries type V357.

Model with min/max/P-P function (543.300)

- Key lock function.

Model for internal measurements (543.310)

- Hold function.
- Spindle movement is graphically displayed (determination of the reversal point).
- Storage for 3 preset values (for example size setting ring).
- Max. measuring speed: any, for 'scanning' measurements: 0.05 mm/s.



543.300



543.390



NEW



543.310

Item No.	Measuring range/mm	Resolution mm	Accuracy mm	Measuring force/N	Price EUR
543.400	0-12.7	0.01	±0.02	≤0.9	259.00
543.474	0-25.4	0.01	±0.02	≤1.8	362.00
543.494	0-50.8	0.01	±0.04	≤2.3	563.00
543.390	0-12.7	0.001	±0.003	≤1.5	344.00
543.470	0-25.4	0.001	±0.003	≤1.8	412.00
543.490	0-50.8	0.001	±0.005	≤2.3	621.00
With a reduced measuring force:					
543.404	0-12.7	0.01	±0.02	≤0.2-0.5	316.00
543.394	0-12.7	0.001	±0.003	≤0.4-0.7	426.00
With min/max/P-P function:					
543.300	0-12.7	0.001	±0.003	≤1.5	428.00
For internal measurements:					
543.310	0-12.7	0.001	±0.003	≤1.5	482.00
Options:					
836.535	Spare battery (543.300 and 543.310: 2 needed)				1.90
905.338	Digimatic signal cable, 1 m				30.00
905.409	Digimatic signal cable, 2 m				36.00
106.384	USB Input Tool Direct cable, 2 m				104.00
102.795	U-WAVE data cable				87.00

Mitutoyo Absolute Digimatic dial indicators ID-B and ID-N

Compact digital dial indicators with the Absolute measuring system and with protection degree IP66. Flexible mounting because the display can also display upside-down.

- Measuring range: 0- 12.7 mm.
- Resolution: 0.01 or 0.001 mm.
- ABS/INC switchable.
- Digimatic data output.
- On/off switch.
- Reset/preset.
- Hold function.
- Max. measuring speed: any.
- Measuring force: ≤ 2 N (0- 5 mm),
 ≤ 2.5 N (0- 12.7 mm).
- Clamping stem: $\varnothing 8$ mm.
- Tungsten carbide stylus tip.
- Reversible measuring direction.
- Adjustable tolerance limits.
- Protection: IP66.
- Conforms to factory standard.
- Power supply: 1 battery type V357.



Top view 543.580



543.580
(543.585)



543.575
(543.570)

*Data cables Digimatic, USB Input Tool Direct,
U-WAVE available on request.*

Item No.	Measuring range/mm	Resolution mm	Accuracy mm	Price EUR
543.580	0- 5	0.01	± 0.02	253.00
543.585	0- 5	0.001 / 0.01	$\pm 0.003 / \pm 0.01$	337.00
543.570	0- 12.7	0.01	± 0.02	227.00
543.575	0- 12.7	0.001 / 0.01	$\pm 0.003 / \pm 0.01$	312.00
Option:				
836.535	Spare battery			1.90



Mitutoyo Absolute Digimatic dial indicators with calculation function ID-C

Multi-functional dial indicators with absolute measuring system and built-in calculation function for various applications. The results, for example inside and outside diameter, groove width, bore diameter and curve radius, are determined based on the spindle displacement x ; formula: $Ax + B + Cx^{-1}$. The coefficients A, B and C can be set and the calculations are processed and displayed real-time. Besides the calculation function these dial indicators have the following functions: tolerance judgement, zero point setting, memory for min/max value, hold function and data output.

- Measuring range: 0 - 50.8 mm.
- Resolution: 0.0002 to 1 mm, switchable.
- ABS/INC switchable.
- LCD display 330° rotatable.
- Digimatic data output.
- Reset/preset.
- Max. measuring speed: any.
- Clamping stem: $\varnothing 8$ mm.
- Adjustable tolerance limits.
- Protection: IP42.
- Power supply: 1 battery type V357.

Item No.	Measuring range/mm	Accuracy mm	Measuring force/N	Price EUR
543.340	0 - 12.7	± 0.003	≤ 1.5	525.00
543.590	0 - 25.4	± 0.003	≤ 1.8	606.00
543.595	0 - 50.8	± 0.006	≤ 2.3	728.00

Options:

836.535	Spare battery	1.90
905.338	Digimatic signal cable, 1 m	30.00
905.409	Digimatic signal cable, 2 m	36.00
106.384	USB Input Tool Direct cable, 2 m	104.00
102.795	U-WAVE data cable	87.00
210.198	Retraction lever	8.00
540.774	Cable retraction device	28.00
101.040	Back plate with lug	8.00



Bridges

A number of standard bridges have been developed for these indicators to provide several convenient measuring solutions. The accuracy depends on the radius and form deviation of the workpiece. Custom-made bridges are also possible.

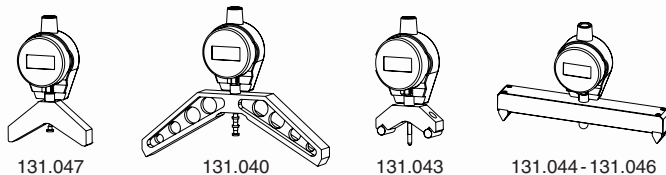

Item No.	Description	Price EUR
131.047	Bridge, $r = 15 - 80$ mm	207.00
131.040	Bridge, $r = 40 - 210$ mm	287.00
131.043	Bridge, $r > 40$ mm	217.00
131.044	Bridge, $r > 120$ mm	230.00
131.045	Bridge, $r > 420$ mm	249.00
131.046	Bridge, $r > 1000$ mm	267.00

Digital dial indicators TESA Digico

Digital dial indicators with digital and digital-analog read-out. Authentic Swiss made product.

- Measuring range: 0-25 mm.
- Resolution: 0.01 or 0.001 mm.
- mm/inch conversion.
- USB/RS232C data output.
- Automatic switch-off.
- Absolute mode (spindle position is also read after automatic switch-off).
- Reset.
- Measuring force: ≤ 2.0 N.
- Dial diameter: 57 mm.
- Reversible measuring direction.
- Adjustable tolerance markers.
- Key lock function.
- Protection: IP62 (only 783.084).
- DIN 878.
- Delivery in a case with an inspection report.
- Power supply: 1 battery type CR2032.

TESA Digico 400/500/600/700

The 270° rotatable display guarantees an ideal read-out in any position.

- Preset.
- Overall reset.
- ABS/INC switchable.
- Numerical tolerance limits.
- Function for dynamic measurements (min, max, max-min) and memory for maximum and minimum values (only Digico 600/700).
- Determination of reversal point for internal measurements (only Digico 700).



Item No.	Type	Measuring range/mm	Resolution mm	Accuracy mm	Price EUR
TESA Digico 200/300:					
783.000	205 MI	0-12.5	0.01	± 0.02	259.00
783.035	305 MI	0-12.5	0.001	± 0.008	346.00
TESA Digico 400/500:					
783.142	410 MI	0-25	0.01	± 0.02	494.00
783.084	505 MIP ¹	0-12.5	0.001	± 0.004	496.00
TESA Digico 600:					
783.085	605 MI	0-12.5	0.001	± 0.004	444.00
783.144	610 MI	0-25	0.001	± 0.005	533.00
TESA Digico 700:					
783.086	705 MI	0-12.5	0.001	± 0.004	488.00
Options:					
495.157	Spare battery				0.50
783.001	Connection for AC adapter ²				170.00
782.201	AC adapter (without power cable) ²				66.00
782.202	EU power cable for AC adapter ²				8.60
783.027	Opto-USB cable (2 m)				216.00
781.887	Opto-RS232C cable 9p (2 m)				120.00
781.999	Opto-RS232C cable 9p, bidirectional (2 m)				131.00

¹ With protection IP62.

² To be used together for external power supply.



783.000



Digital mini dial indicators TESA Digico 12/12-HP

Designed for working in the toughest conditions, protected against spraying water, oil and coolants. The diameter of the housing is only 44 mm. Patented, inductive measuring system. The Digico 12-HP dial indicators (*) are high-precision models.

- Measuring range: 0- 12.5 mm.
- Resolution: 0.01 mm or 0.001/0.01 mm.
- Accuracy: ± 0.01 mm.
- Repeatability: 0.005 mm.
- mm/inch conversion.
- ABS/INC switchable (except 12-HP).
- RS232C data output with external power supply.
- Automatic switch-off.
- Preset (except 12-HP) and reset.
- Max. measuring speed: 2 m/s.
- Measuring force: 0.5-0.9 (± 0.15) N.
- Reversible measuring direction (except 12-HP).
- Protection: IP65.
- Delivery with an inspection report (except the 0.01 mm models) and a declaration of conformity.
- Power supply: 1 battery type CR2032.



782.435

TESA Digico 12-HP*

- Accuracy: ± 0.002 mm.
- Repeatability: 0.002 mm.
- With digital-analog display of the measured value (± 0.025 to ± 1.25 mm).
- Lock of automatic switch-off.
- Min/max/P-P function.



782.436

Item No.	Measuring range/mm	Resolution mm	Price EUR
Electronic module IP65 protected:			
782.432	0- 12.5	0.01	315.00
782.434	0- 12.5	0.001/0.01	442.00
782.436*	0- 5	0.001/0.01	465.00
Mechanics and electronics IP65 protected:			
782.433	0- 12.5	0.01	360.00
782.435	0- 12.5	0.001/0.01	494.00
782.437*	0- 5	0.001/0.01	500.00
Option:			
495.157	Spare battery		0.50

Digital dial indicators TESA Digico 1/2

- Measuring range: 0- 60 mm.
- Resolution: 0.001/0.01 mm.
- Hysteresis: 0.001 mm.
- mm/inch conversion.
- Illuminated LCD display with digital-analog representation of the measured value.
- Display rotatable over 90°, 180° and 270°.
- RS232C data output.
- Automatic switch-off.
- Min/max/P-P function.

- Tungsten carbide stylus tip.
- Reversible measuring direction.
- Adjustable tolerance limits and color indication (only when using AC adapter).
- Protection: IP54.
- Delivery with battery, retraction lever, an inspection report and a declaration of conformity.
- Power supply: 1 lithium battery 3.6 V or AC adapter.

Item No.	Type	Measuring range/mm	Accuracy mm	Price EUR
781.416	Digico 1	0- 30	± 0.002	1,103.00
781.707	Digico 2	0- 60	± 0.003	1,628.00
Options:				
781.624	Spare battery			17.00
781.421	AC adapter			92.00
781.862	Cable SPC printer			373.00



781.416



Mitutoyo Absolute Digimatic dial indicators ID-F/ID-H

Very advanced Mitutoyo Absolute dial indicators for the demanding user. Besides the high accuracy, these indicators are equipped with many practical functions, among which an automatic hold function for the maximum and minimum measuring value, calculation of min-max difference value and tolerance judgements with help of a color changing display (red/green).

To optimise the reproducibility and stability of measurements for the ID-H dial indicators an optional remote control device is available with which the indicator can be set up without actually physically making contact.



- Measuring range: 0 - 60.9 mm.
- Resolution: 0.01, 0.001 or 0.0005 mm, switchable.
- RS232C data output (only 543.561/563).
- Digimatic data output.
- On/off switch.
- Reset/preset.
- Clamping stem: $\varnothing 8$ mm.
- Tungsten carbide stylus tip: $\varnothing 3$ mm.
- Reversible measuring direction.
- Adjustable tolerance limits.
- Conforms to factory standard.
- Power supply: AC adapter.



543.561

543.551



210.099

Item No.	Measuring range/mm	Resolution mm	Accuracy mm	Measuring force/N	Price EUR
ID-F					
543.551	0- 25	0.01/0.001	± 0.003	≤ 1.8	606.00
543.553	0- 50	0.01/0.001	± 0.006	≤ 2.3	659.00
543.557	0- 50	0.01/0.001	± 0.003	≤ 2.3	810.00
ID-H					
543.561	0-30.4	0.001/0.0005	± 0.0015	≤ 2.0	632.00
543.563	0-60.9	0.001/0.0005	± 0.0025	≤ 2.5	685.00
Options:					
210.099*	Remote control				79.00
540.774	Cable retraction device, 12 mm stroke				28.00
210.131*	RS232C cable, 2 m				199.00
936.937	Digimatic signal cable without data switch, 1 m				46.00
965.014	Digimatic signal cable without data switch, 2 m				60.00
106.383	USB Input Tool Direct cable, 2 m				104.00
102.791	U-WAVE data cable				97.00

* Only for ID-H.

Magnescale digital indicators

- Measuring range: 0-60 mm.
- Resolution: 0.001 mm.
- mm/inch conversion.
- RS232C data output.
- Min/max/P-P function.
- Measuring force U12B: ≤1.3 N,
U30B: ≤1.5 N,
U60B: ≤2.2 N.
- Reversible measuring direction.
- Mounting by:
 - a) clamping stem ø8 mm,
 - b) thread M12x1, length 8 mm (including nut M12).
- Air damped travel.
- Power supply: AC adapter (6 Vdc, 500 mA).
- Delivery without AC adapter.



344.409



344.437

402.165

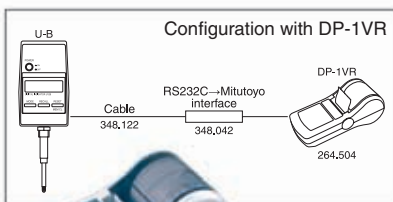

Configuration with DP-1VR



264.504

937.179



Item No.	Type	Measuring range/mm	Accuracy mm	Price EUR
344.431	U12B-F	0-12	±0.001	550.00
344.430	U30B-F	0-30	±0.001	609.00
344.432	U60B-F	0-60 ¹	±0.0015	655.00
Options:				
334.694	Mini AC adapter (6 Vdc)			28.00
344.409	Set of 4 probes DZ5100			182.00
344.437	Pneumatic retraction device DZ173 (maximum travel 34 mm)			89.00
540.774	Cable retraction device (12 mm)			28.00
402.165	Stand 150 mm, granite table			169.00
334.690	Stand 135 mm, alumina ceramic grooved table			355.00
348.122	RS232C cable 9p			46.00
264.504	Mitutoyo DP-1VR SPC printer ²			463.00
348.042	RS232C→Mitutoyo interface ³			53.00
937.179	Foot switch			44.00
900.825	Printing paper (5 rolls)			28.00

¹ The maximum travel is 34 mm with pneumatic retraction device or cable retraction device.

² Incl. AC adapter (6 Vdc) and a roll of printing paper.

³ Makes e.g. the Magnescale signal suitable for the DP-1VR printer (also requires cable 348.122).

Dial indicators 0.01 mm

Indicators with an excellent price-performance ratio.

- Measuring range: 0- 10 mm.
- Graduation: 0.01 mm.
- Clamping stem: \varnothing 8 mm.
- Dial diameter: 55 mm.
- Rotatable dial.
- Shockproof.
- Adjustable tolerance markers.
- Flat back.
- Delivery with an inspection report.
- Retraction lever available on request (only 907.929/930).



Item No.	Measuring range/mm	Price EUR
907.928	0- 3	14.00
907.929	0- 5	14.40
907.930	0- 10	15.10
Option:		
908.799	Back with lug	1.90



Dial indicators 0.01 mm

Indicators with a large dial and a locking screw. Shockproof design.

- Measuring range: 0- 10 mm.
- Graduation: 0.01 mm.
- Clamping stem: \varnothing 8 mm.
- Dial diameter: 60 mm.
- Rotatable dial.
- Shockproof.
- Adjustable tolerance markers.
- Locking screw.
- Flat back.
- Delivery with an inspection report.



Item No.	Measuring range/mm	Price EUR
907.931	0- 3	14.40
907.932	0- 5	15.10
907.933	0- 10	15.70
Option:		
908.987	Back with lug	1.90



Dial indicators 0.01 mm

Indicators with a large measuring range. Shockproof design.

- Measuring range: 0 - 100 mm.
- Graduation: 0.01 mm.
- Clamping stem: \varnothing 8 mm.
- Rotatable dial.
- Shockproof.
- Adjustable tolerance markers (except 907.916).
- Locking screw.
- Flat back.
- Delivery with an inspection report.



907.934



907.935

907.936



907.916

Item No.	Measuring range/mm	Dial \varnothing /mm	Price EUR
907.934	0 - 25	60	27.10
907.935	0 - 30	60	28.20
907.936	0 - 50	76	63.00
907.916	0 - 100	80	119.00
Options:			
	908.987 ¹ Back with lug		1.90
	908.988 ² Back with lug		2.70

¹ For 907.934/935.

² For 907.936/916.

Splashproof dial indicators 0.01 mm

Indicators with splashproof design.

- Measuring range: 0 - 10 mm.
- Graduation: 0.01 mm.
- Clamping stem: \varnothing 8 mm.
- Dial diameter: 55 mm.
- Rotatable dial.
- Shockproof.
- Adjustable tolerance markers.
- Locking screw.
- Back with lug.
- Protection: IP54.
- Conforms to factory standard.



908.779

Item No.	Measuring range/mm	Price EUR
908.777	0 - 3	37.40
908.778	0 - 5	39.10
908.779	0 - 10	41.00



Miniature dial indicators 0.01 and 0.001 mm

Indicators with very small dimensions and an excellent price-performance ratio. Shockproof design.

- Measuring range: 0- 10 mm.
- Graduation: 0.01 or 0.001 mm.
- Clamping stem: \varnothing 8 mm.
- Dial diameter: 40 mm.
- Rotatable dial.
- Shockproof.
- Adjustable tolerance markers.
- Locking screw.
- Flat back.
- Delivery with an inspection report.



Item No.	Measuring range/mm	Price EUR
Graduation 0.01 mm:		
907.925	0- 3	16.30
907.926	0- 5	16.30
907.927	0- 8	17.20
907.914	0- 10	18.10
Graduation 0.001 mm:		
907.920	0- 1	45.00
Option:		
908.986	Back with lug	1.30



Dial indicators 0.001 mm

Indicators with micrometer reading. Shockproof design.

- Measuring range: 0- 5 mm.
- Graduation: 0.001 mm.
- Clamping stem: \varnothing 8 mm.
- Dial diameter: 60 mm.
- Rotatable dial.
- Scale numbering: 0- 100- 0 (907.921: 0- 100).
- Shockproof.
- Adjustable tolerance markers.
- Locking screw.
- Flat back.
- Delivery with an inspection report.



Item No.	Measuring range/mm	Price EUR
907.921	0- 1	38.70
907.922	0- 2	59.00
907.923	0- 3	59.00
907.924	0- 5	91.00
Option:		
908.987	Back with lug	1.90



Peacock dial indicators 0.1 and 0.01 mm

- Measuring range: 0-80 mm.
- Graduation: 0.1 or 0.01 mm.
- Clamping stem: \varnothing 8, 10 or 14 mm.
- Rotatable dial.
- Adjustable tolerance markers.
- Flat back or back with lug*.
- DIN 878.
- Delivery in a case.

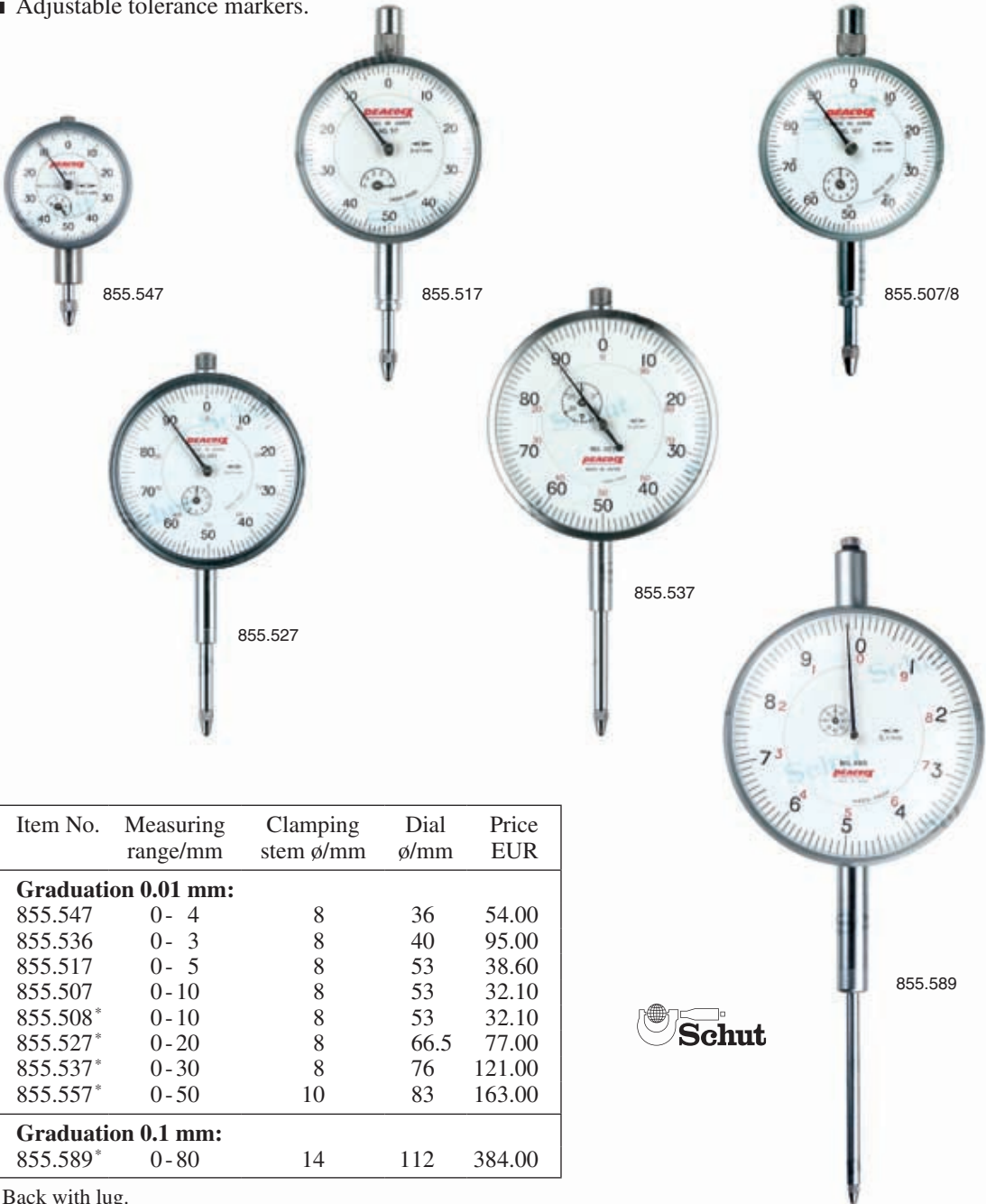

Item No.	Measuring range/mm	Clamping stem \varnothing /mm	Dial \varnothing /mm	Price EUR
Graduation 0.01 mm:				
855.547	0- 4	8	36	54.00
855.536	0- 3	8	40	95.00
855.517	0- 5	8	53	38.60
855.507	0-10	8	53	32.10
855.508*	0-10	8	53	32.10
855.527*	0-20	8	66.5	77.00
855.537*	0-30	8	76	121.00
855.557*	0-50	10	83	163.00
Graduation 0.1 mm:				
855.589*	0-80	14	112	384.00

* Back with lug.



Peacock dial indicators 0.005 and 0.001 mm

- Measuring range: 0-5 mm.
- Graduation: 0.005 or 0.001 mm.
- Clamping stem: $\varnothing 8$ mm.
- Rotatable dial.
- Flat back or back with lug*.
- DIN 878.
- Delivery in a case.

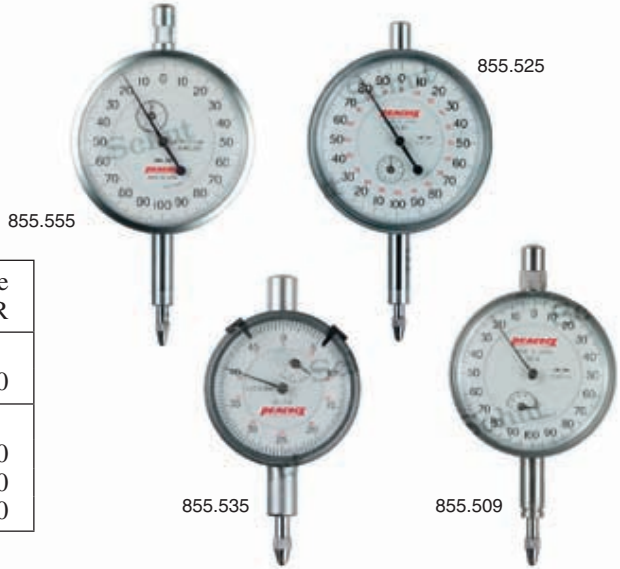

Item No.	Measuring range/mm	Dial \varnothing /mm	Price EUR
Graduation 0.005 mm:			
855.535*	0-3	47	100.00
Graduation 0.001 mm:			
855.509	0-1	53	65.00
855.525*	0-2	66.5	128.00
855.555*	0-5	66.5	188.00

* Back with lug.

Peacock dial indicators with back plunger

The back plunger dial indicator is characterized with easy handling since the spindle with the contact point is moving in the direction perpendicular to the dial face and the gauge is more compact. The dial indicator of this type is convenient for use in achieving a parallelism of the table of the machine tool, with measuring jigs, in restricted areas and on locations where scale reading is difficult.

- Measuring range: 0-5 mm.
- Graduation: 0.01 mm.
- Repeatability: 0.005 mm.
- Hysteresis: ± 0.006 mm.
- Measuring force: 1.4 N.
- Rotatable dial.
- Scale numbering: 0-100.
- DIN 878.
- Delivery in a case.

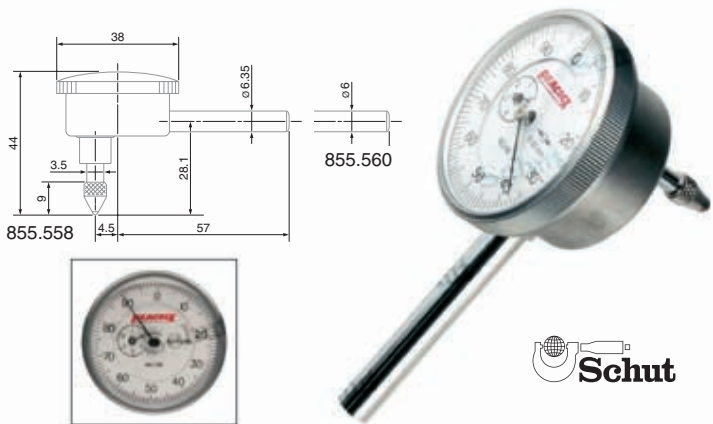

Item No.	Measuring range/mm	Clamping stem \varnothing /mm	Accuracy mm	Price EUR
855.558	0-5	6.35	± 0.02	74.00
855.560	0-5	6	± 0.02	73.00
Clamping stem on back side:				
855.559	0-5	8	± 0.02	74.00

Mitutoyo dial indicators 0.01 and 0.001 mm

Dial indicators from Mitutoyo with a very favourable price-performance ratio. In our catalog we only represent a small part of the Mitutoyo program, but we can supply all the Mitutoyo products.

- Graduation: 0.01 or 0.001 mm.
- Clamping stem: $\varnothing 8$ mm.
- Dial diameter: 55.6 mm.
- Rotatable dial with locking screw and adjustable tolerance markers.
- Delivery in a case.
- Various models available.

Graduation 0.01 mm

- Measuring range: 0-10 mm.
- Accuracy: ± 0.013 mm.
- Max. hysteresis: 0.003 mm.
- Measuring force: 1.4 N.
- 1 pointer revolution = 1 mm.
- Scale numbering: 0-100 (100-0).
- Flat back or back with lug¹.
- DIN 878.



204.608



211.000



210.911

Item No.	Measuring range/mm	Graduation mm	Price EUR
204.608 ¹	0-10	0.01	34.00
204.612	0-10	0.01	34.00
204.660 ²	0-10	0.01	118.00

¹ Back with lug.

² Splashproof model; measuring force 2.5 N.



Graduation 0.001 mm

- Measuring range: 0-1 mm.
- Accuracy: ± 0.005 mm.
- Max. hysteresis: 0.002 mm.
- Flat back. (Back with lug available on request.)
- Conforms to factory standard.

Item No.	Measuring range/mm	Graduation mm	1 pointer revolution	Scale numbering	Measuring force/N	Price EUR
210.911	0-1	0.001	0.2 mm	0-100-0	1.5	89.00
211.000	0-1	0.001	0.1 mm	0-100 (100-0)	1.5	114.00

TESA dial indicators 0.01 and 0.001 mm

TESA precision dial indicators with a high accuracy and a special construction guaranteeing a very long life.

- Measuring range: 0-30 mm.
- Graduation: 0.01 or 0.001 mm.
- Clamping stem: \varnothing 8 mm.
- Rotatable dial with adjustable tolerance markers.
- Shockproof, except 781.681/683.
- Flat back.
- DIN 878, except 783.221, 782.724.
- Delivery with an inspection report and a declaration of conformity.







783.221



781.681



779.921



782.724



783.145

Item No.	Measuring range/mm	Dial \varnothing /mm	Scale numbering	Price EUR
Graduation 0.01 mm:				
783.221	0- 1	58	50-0-50	295.00
781.681 ¹	0- 5	40	0- 50	218.00
779.921 ²	0- 5	40	0- 50	277.00
779.944 ²	0-10	57	0-100	312.00
782.724	0-10	58	0-100	60.00
781.686 ¹	0-10	58	0-100	105.00
783.145 ¹	0-30	58	0-100	451.00
Graduation 0.01 mm, protection IP54:				
781.683 ¹	0- 5	40	0- 50	147.00
779.925 ²	0- 5	40	0- 50	288.00
Graduation 0.001 mm:				
781.684 ¹	0- 1	40	0-100	348.00
779.910 ²	0- 1	40	0-100	463.00
781.693 ¹	0- 1	58	0-100	389.00
781.695 ¹	0- 5	58	0-200	400.00
Graduation 0.001 mm, protection IP54:				
781.685 ¹	0- 1	40	0-100	310.00
781.696 ¹	0- 1	58	0-100	448.00



779.925



781.685



¹ Clamping stem and measuring pin out of hardened stainless steel.

² With retraction device facility and dial lock.

Käfer dial indicators 0.01 mm

These recently developed Käfer dial indicators are very stable and have a very good price-performance ratio. Also available in a shockproof design, where blows against the plunger can not damage the mechanics.

- Measuring range: 0- 10 mm.
 - Graduation: 0.01 mm.
 - Clamping stem: \varnothing 8 mm.
 - Dial diameter: 40 mm.
 - Scale numbering: 0- 50 (852.291: 0- 100).
 - Adjustable tolerance markers.
 - Flat back.
 - Clamping stem and measuring pin out of hardened stainless steel.
- DIN 878.
 - Delivery in a case.

Item No.	Measuring range/mm	Graduation mm	Price EUR
852.350	0- 3	0.01	39.10
852.352	0- 5	0.01	50.00
Shockproof design:			
852.351	0- 3	0.01	48.00
852.353	0- 5	0.01	62.00
852.291	0- 10	0.01	69.00



Käfer dial indicators 0.01 mm

These dial indicators have an almost constant measuring force of 1 N over the total measuring range. This is achieved through a built-in lever construction. The shockproof design protects the mechanics against harsh blows and reduces the possibility of damage. The shockproof design has an unbreakable cover glass.

- Measuring range: 0- 10 mm.
- Graduation: 0.01 mm.
- Measuring force: approx. 1 N.
- Clamping stem: \varnothing 8 mm.
- Dial diameter: 58 mm.
- Scale numbering: 0- 100.
- Adjustable tolerance markers.
- Flat back.
- DIN 878.
- Delivery in a case.

Item No.	Measuring range/mm	Graduation mm	Price EUR
852.354	0- 10	0.01	37.50
Shockproof design:			
852.355	0- 10	0.01	40.00



Käfer dial indicators 0.01 mm

These Käfer dial indicators combine a large measuring range with a high accuracy. The clear dials ensure an easy read-out. Thanks to the special construction, these dial indicators have an almost constant measuring force on the whole measuring range.

- Measuring range: 0- 100 mm.
- Graduation: 0.01 mm.
- Measuring force: approx. 1 N
(852.290 approx. 1.5 N, 852.289 approx. 1.2 N).
- Clamping stem: \varnothing 8 mm.
- Dial diameter: 58 mm.
- Rotatable dial.
- Adjustable tolerance markers.
- Flat back.
- Clamping stem and measuring pin out of hardened stainless steel.
- Conforms to factory standard.
- Delivery in a case.

Item No.	Measuring range/mm	Accuracy mm	Scale numbering	Price EUR
852.356	0- 30	± 0.02	0- 100	89.00
852.357	0- 50	± 0.025	0- 100	127.00
852.290	0- 80	± 0.030	0- 100	262.00
852.289	0- 100	± 0.050	0- 100	333.00



Käfer Feinika dial indicators 0.001 mm

The Käfer Feinika dial indicators have a special construction without gear wheels, comparable to the precision dial indicators. A special lever construction enlarges the measuring range up to 1 mm. This lever construction gives the Feinika a very low hysteresis of maximal 1.5 μ m, making it very suitable for very accurate comparative measurements where a large measuring range is necessary. Just like the precision dial indicators the Feinika has a resolution of 0.001 mm.



- Measuring range: 0- 1 mm.
- Graduation: 0.001 mm.
- Hysteresis: ≤ 0.0015 mm.
- Clamping stem: \varnothing 8 mm.
- Shockproof.
- Adjustable tolerance markers.
- Conforms to factory standard.
- Delivery in a case.

Item No.	Measuring range/mm	Accuracy mm	Dial \varnothing /mm	Scale numbering	Price EUR
852.358	0- 1	± 0.004	40	0- 100	162.00
852.359	0- 1	± 0.004	58	0- 100	162.00

Precision dial indicator

Highly accurate shockproof dial indicator for measurements from a fixed reference point. Very suitable for internal measuring instruments and dial indicator stands for example.

- Measuring range: 0.1 mm.
- Graduation: 0.001 mm.
- Measuring force: <2 N.
- Clamping stem: $\varnothing 8$ mm.
- Travel: 3 mm.
- Adjustable tolerance markers.
- Fine adjustment.
- Delivery with an inspection report.



NEW



Item No.	Measuring range/mm	Dial \varnothing /mm	Price EUR
907.939	0.1	63.5	138.00



Käfer Compika precision dial indicators

Accurate precision dial indicators with stable, multiple ball-bearing mechanics. Because of that the Compika has a very low hysteresis. Easy to set by the fine adjustment on top of the dial indicator, that has a protective knob to prevent unintentional displacement of the pointer.

- Measuring range: 0.1 mm.
- Graduation: 0.001 mm.
- Measuring force: approx. 1 N.
- Clamping stem: $\varnothing 8$ mm.
- Max. probe travel: 3 mm.
- Ball bearing probe rod.
- Protective knob.
- Shockproof.
- Waterproof (only 852.386).
- Adjustable tolerance markers.
- Fine adjustment.
- Clamping stem and measuring pin out of hardened stainless steel.
- DIN 879.
- Delivery in a case.

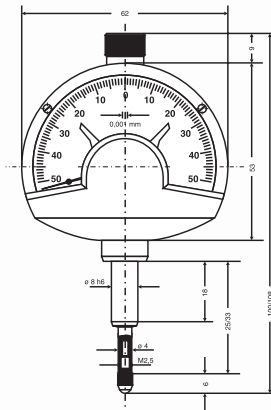

852.360



852.386

Item No.	Measuring range/mm	Waterproof	Dial \varnothing /mm	Scale numbering	Price EUR
852.360	0.1	no	62	50-0-50	154.00
852.386	0.1	yes	62	50-0-50	197.00

Precision dial indicators

- Measuring range: 0.06 mm.
- Graduation: 0.0005 mm or 0.001 mm.
- Measuring force: approx. 1 N.
- Clamping stem: $\varnothing 28$ mm.
- Shockproof.
- Fine adjustment.

Item No.	Measuring range/mm	Resolution mm	Scale numbering	Price EUR
906.332	0.03	0.0005	15-0-15	90.00
906.333	0.06	0.001	30-0-30	61.00



Schwenk precision dial indicators

Highly accurate shockproof dial indicators for measurements from a fixed reference point. Very suitable for internal measuring instruments and dial indicator stands for example.

- Measuring range: up to 0.5 mm.
- Graduation: 0.01 or 0.001 mm.
- Measuring force: approx. 1 N.
- Clamping stem: $\varnothing 8$ mm.
- Dial diameter: 63 mm.
- Max. probe travel: 3 mm.
- Ball bearing probe rod.
- Adjustable tolerance markers.
- DIN 879.
- Delivery in a case.

Item No.	Type	Measuring range/mm	Graduation mm	Price EUR
852.640	Mytast	0.1	0.001	174.00
852.641	Centitast	0.5	0.01	138.00



Etalon precision dial indicators

- Measuring range: 0.1 mm.
- Graduation: 0.001 mm.
- Measuring force: approx. 1 N.
- Clamping stem: $\varnothing 8$ mm.
- Max. probe travel: 3 mm.
- Shockproof.
- Waterproof (only 781.700).
- Adjustable tolerance markers.
- Fine adjustment.
- Clamping stem and measuring pin out of hardened stainless steel.
- DIN 879.
- Delivery in a case with a lifting cable.



Item No.	Measuring range/mm	Waterproof	Dial \varnothing /mm	Price EUR
781.699	0.1	no	62	283.00
781.700	0.1	yes	62	321.00

Inserts and extensions

Most dial indicators are equipped with an interchangeable insert with thread M2.5. Besides the inserts shown below various other types are available.

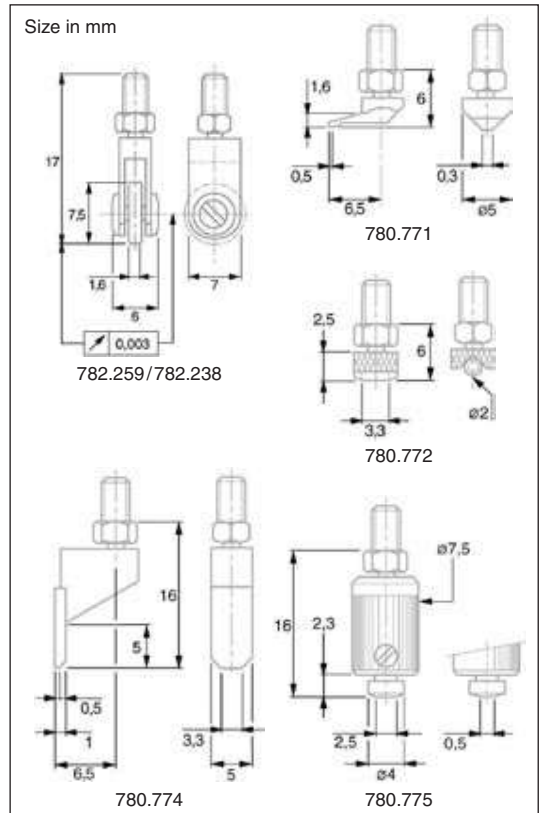
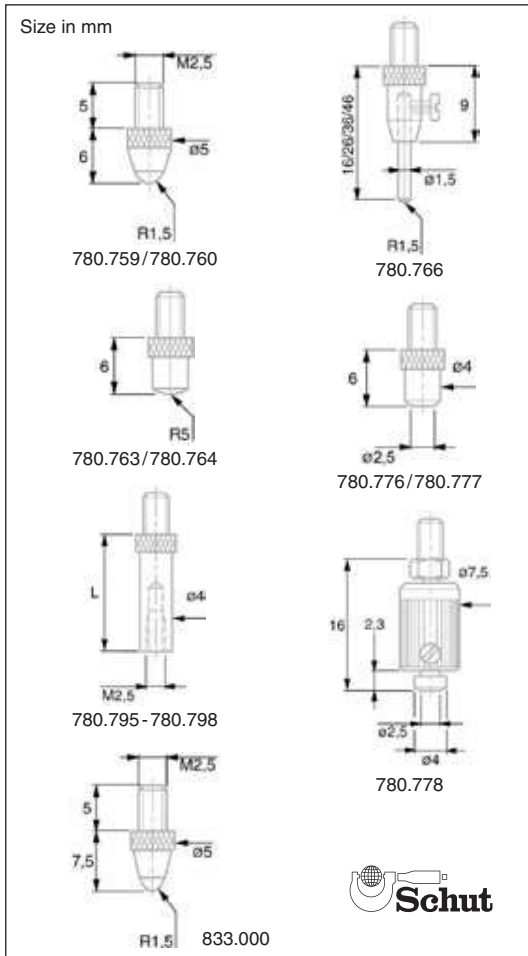

Item No.	Type	Price EUR
Ball radius 1.5 mm:		
780.759	Steel	4.90
780.760	Tungsten carbide	9.60
780.766	4 interchangeable inserts	26.00
Ball radius 5 mm:		
780.763	Steel	23.00
780.764	Tungsten carbide	46.00
Flat:		
780.776	Steel	27.00
780.777	Tungsten carbide	49.00
780.778	Flat, adjustable meas. face	370.00

Item No.	Type	Price EUR
Special forms:		
782.259	Roller with a cylindrical measuring face	111.00
782.238	Roller with a ball-shaped measuring face	103.00
780.771	Offset point	48.00
780.772	Cylindrical point	48.00
780.774	Offset line contact face	71.00
780.775	V-shaped adjustable point	435.00
Extensions:		
780.795	10 mm	8.00
780.796	15 mm	8.00
780.797	20 mm	8.00
780.798	40 mm	8.00
Special probe head:		
833.000	Ceramic ball \varnothing 3 mm	32.00

Käfer inserts

Inserts with thread M2.5. The inserts are made of steel unless otherwise indicated; tungsten carbide (TC), ruby (R) or sapphire (S).

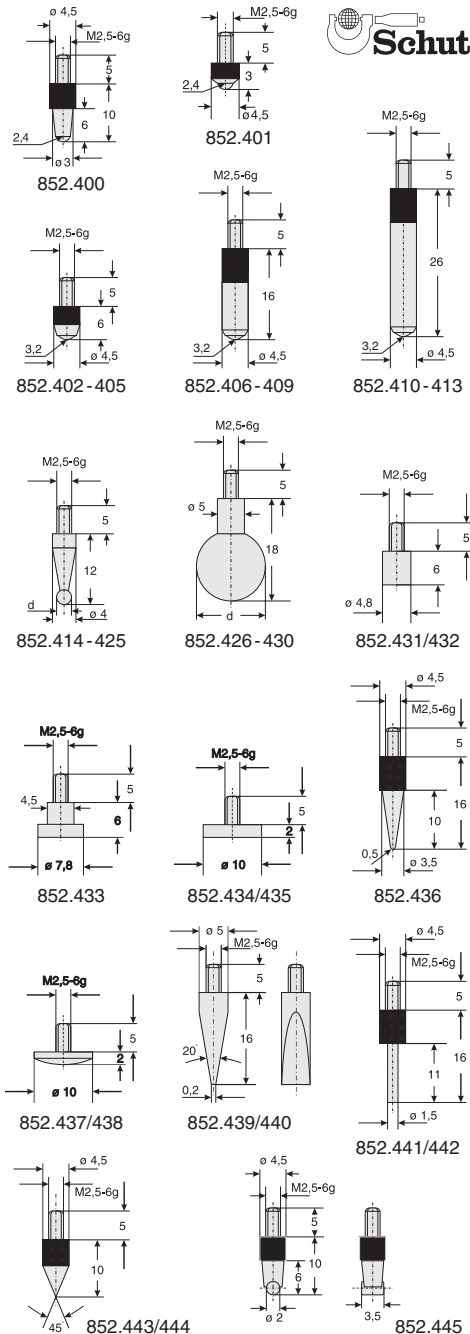

Item No.	Description	Price EUR
Ball probes:		
852.400	d= 2.4 mm l= 10 mm	3.50
852.401	d= 2.4 mm l= 3.0 mm	1.30
852.402	d= 3.2 mm l= 6.0 mm	1.10
852.403	d= 3.2 mm l= 6.0 mm	TC 5.00
852.404	d= 3.2 mm l= 6.0 mm	R 6.70
852.405	d= 3.2 mm l= 6.0 mm	S 6.70
852.406	d= 3.2 mm l= 16 mm	3.60
852.407	d= 3.2 mm l= 16 mm	TC 12.10
852.408	d= 3.2 mm l= 16 mm	R 9.70
852.409	d= 3.2 mm l= 16 mm	S 9.70
852.410	d= 3.2 mm l= 26 mm	3.60
852.411	d= 3.2 mm l= 26 mm	TC 12.10
852.412	d= 3.2 mm l= 26 mm	R 9.70
852.413	d= 3.2 mm l= 26 mm	S 9.70
852.414	d= 1.0 mm l= 12 mm	7.80
852.420	d= 1.0 mm l= 12 mm	TC 23.50
852.415	d= 2.0 mm l= 12 mm	7.80
852.421	d= 2.0 mm l= 12 mm	TC 23.50
852.416	d= 3.0 mm l= 12 mm	7.80
852.422	d= 3.0 mm l= 12 mm	TC 23.50
852.417	d= 4.0 mm l= 12 mm	7.80
852.423	d= 4.0 mm l= 12 mm	TC 23.50
852.418	d= 5.0 mm l= 12 mm	7.80
852.424	d= 5.0 mm l= 12 mm	TC 23.50
852.419	d= 6.0 mm l= 12 mm	7.80
852.425	d= 6.0 mm l= 12 mm	TC 23.50
852.426	d= 7.0 mm l= 18 mm	8.30
852.427	d= 8.0 mm l= 18 mm	8.30
852.428	d= 9.0 mm l= 18 mm	8.30
852.429	d= 10.0 mm l= 18 mm	8.30
852.430	d= 11.0 mm l= 18 mm	8.30
Flat probes:		
852.431	d= 4.8 mm l= 6 mm	4.30
852.432	d= 4.8 mm l= 6 mm	TC 28.10
852.433	d= 7.8 mm l= 6 mm	5.30
852.434	d= 10.0 mm l= 2 mm	4.80
852.435	d= 10.0 mm l= 2 mm	TC 46.00
Spherical probes:		
852.436	conical l= 16 mm	5.80
852.437	d= 10.0 mm l= 2.0 mm	6.10
852.438	d= 10.0 mm l= 2.0 mm	TC 95.00
Knife-edged probes:		
852.439	d= 5.0 mm l= 16 mm	9.20
852.440	d= 5.0 mm l= 16 mm	TC 61.00
Needle-shaped probes:		
852.441	d= 1.5 mm l= 16 mm	7.20
852.442	d= 1.5 mm l= 16 mm	TC 24.00
Tapered probes:		
852.443	d= 4.5 mm l= 10 mm	5.80
852.444	d= 4.5 mm l= 10 mm point 45°	TC 50.00
Probe with cylindrical measuring face:		
852.445	d= 2 x 3.5 mm l= 10 mm	10.40

Extensions for inserts

Steel extensions for inserts with thread M2.5.

Item No.	Length mm	Price EUR
Extensions with A = \varnothing 4 mm:		
852.446	10	4.20
852.447	15	4.20
852.448	20	4.20
852.449	25	4.20
852.450	30	4.20
852.451	35	4.20
852.452	40	4.20
852.453	45	4.20
852.454	50	4.20
852.455	55	4.20
852.456	60	4.20
852.457	65	4.20
852.458	70	4.20
852.459	75	4.20
852.460	80	4.20
852.461	85	4.20
852.462	90	4.20
852.463	95	4.20
852.464	100	4.20

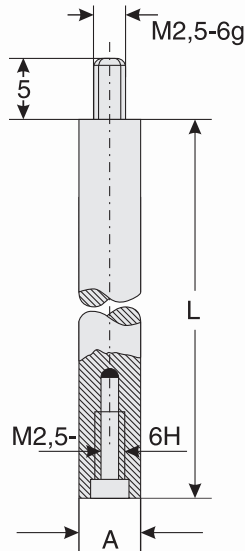

Item No.	Length mm	Price EUR
Extensions with A = \varnothing 5 mm:		
852.465	10	4.30
852.466	15	4.30
852.467	20	4.30
852.468	25	4.30
852.469	30	4.30
852.470	35	4.30
852.471	40	4.30
852.472	45	4.30
852.473	50	4.30
852.474	55	4.30
852.475	60	4.30
852.476	65	4.30
852.477	70	4.30
852.478	75	4.30
852.479	80	4.30
852.480	85	4.30
852.481	90	4.30
852.482	95	4.30
852.483	100	4.30

Adapters for inserts

Adapter for attaching other inserts to dial indicators and probes with an interchangeable insert with thread M2.5.

Item No.	External/internal thread	Price EUR
960.276	M2.5/M2	6.30

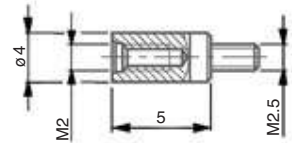

Depth measuring bases for dial indicators

Bases which make dial indicators and probes suitable for depth measurements.

- Clamping shaft: 8H7.

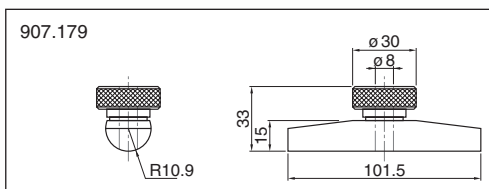
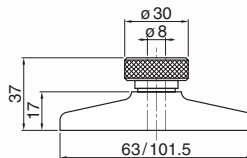

Item No.	Measuring face l x w/mm	Price EUR
907.153	63 x 17	16.40
907.165	101.5 x 17	17.20
With cylindrical measuring face:		
907.179	101.5 x R10.9	20.60

Retraction levers

To determine the right type of retraction lever please contact our sales department.

Retraction lever

Universal retraction lever, bottom mounted. This lever is fully compatible with TESA dial indicators, but can also be used with a wide range of other dial indicators.



780.782

Item No.	Description	Price EUR
780.782	Retraction lever	77.00
Consisting of:		
780.779	Lever	74.00
780.780	Washer	3.50

Retraction lever

Universal retraction lever, bottom mounted and compatible with any dial indicator with an interchangeable probe with M2.5 thread.



Item No.	Description	Price EUR
781.727	Retraction lever	22.00

Retraction lever

Universal retraction lever, bottom mounted and compatible with any dial indicator.



Item No.	Description	Price EUR
137.693	Retraction lever	2.00

Retraction levers

Universal retraction levers, top mounted. These levers are fully compatible with TESA and Käfer dial indicators of the given diameters, but can also be used with a wide range of other dial indicators.



782.321

Item No.	Description	Dial ø/mm	Price EUR
782.320	TESA lever	40	27.00
782.321	TESA lever	58	25.00
852.387	Käfer lever	58	6.10

Mitutoyo retraction levers

Universal retraction levers, top mounted. These levers are fully compatible with Mitutoyo dial indicators of the given series, but can also be used with a wide range of other dial indicators.



Item No.	Description	Price EUR
900.527	For series 1	6.00
900.525	For series 2	6.00
903.424	For series 3 and ID-S	7.00
902.011*	For series ID-C	6.00

* Only for ID-C with 12 mm measuring range.

Clamping bush



Item No.	Description	Price EUR
780.398	Clamping bush VKE	9.30
780.397	Clamping screw VKD	4.30

Swivel-type probe

Swivel-type probe for dial indicators with M2.5 thread. The probe can be oriented over 180°. Equipped with a steel ball probe $\varnothing 3$ mm.

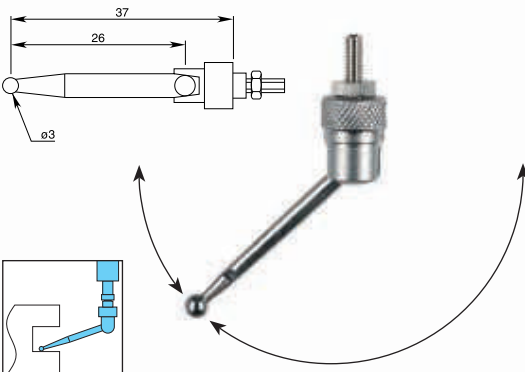

Item No.	Description	Price EUR
900.391	Swivel-type probe	24.00

Clamping bush

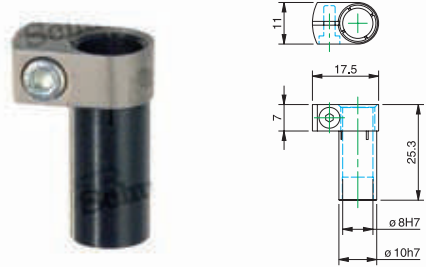

Item No.	Description	Price EUR
906.497	Clamping bush	39.20

Angle probe

Angle probe used for the transmission of the plunger movements up to 10 mm. Suited for dial indicators with a 0.01 mm graduation. Delivery incl. flat insert $\varnothing 5$ mm.

- Probe measuring range: 10 mm.
- Clamping shaft: $\varnothing 8$ mm.



Item No.	Description	Price EUR
782.440	Angle probe	172.00

Angle probe and special probe

Probes e.g. for checks and alignments of bores on lathes.

- Probe measuring range: 10 mm.
- Measuring depth: 30 mm (856.149) or 60 mm (856.150).
- Clamping stem: $\varnothing 8$ mm.
- Clamping shaft: $\varnothing 8$ mm.

Item No.	Description	Price EUR
856.149	Angle probe	48.00
856.150	Special probe	46.00



Peacock dial indicator tester

For checking the accuracy of dial indicators, lever-type dial test indicators and gauges.

- Measuring range: 20 mm (max. spindle thread pitch: 25 mm).
- Graduation: 0.001 mm.
- Accuracy: ± 0.002 mm.
- Several mounting possibilities: vertical intake $\varnothing 8$ mm, horizontal intake $\varnothing 6$ mm.
- Please see the dial test indicator accessories section for other mounting possibilities.
- Provided with mirror for dials facing upward.
- Type NB.
- Delivery in a case with an inspection report.

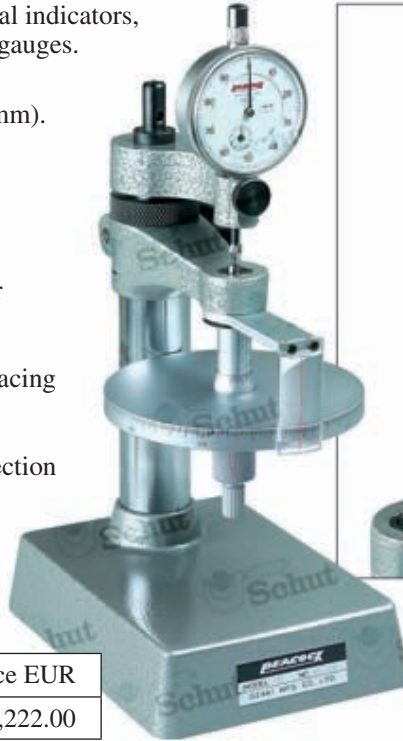

Item No.	Description	Price EUR
855.620	Dial indicator tester	1,222.00

Dial indicator backs

Dial indicators are by default delivered with either a flat back or a back with lug. For many dial indicators alternative back plates are available, which considerably increases the flexibility for mounting the dial indicators.

The many possible combinations make it impossible to specify them all. The given selection is an impression of the possibilities.



With lug in the middle



With threaded bush



With shifted lug



With adjustable fixture



With magnet



With fixing shank



Flat back

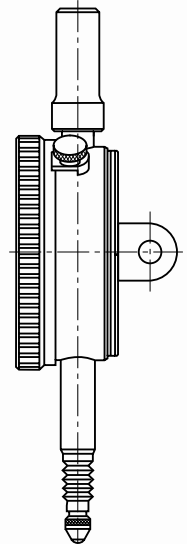

Lever-type digital test indicator

Lever-type digital test indicator with analog display. Equipped with three dovetail mountings.

- Measuring range: up to 0.5 mm.
- Resolution: 0.01 mm.
- Accuracy: ± 0.02 mm.
- mm/inch conversion.
- On/off switch.
- Reset.
- Hold function.
- Min/max/P-P function.
- Measuring force: ≤ 0.6 N.



- Rotatable dial: 350°.
- With dovetail joint and clamping stems $\varnothing 6$ and $\varnothing 8$ mm.
- Stylus tip: $\varnothing 2$ mm.
- 230° adjustable measuring insert.
- Power supply: 1 battery type V357.

NEW



Item No.	Measuring range/mm	Resolution mm	Insert length/mm	Price EUR
910.087	0.5	0.01	13	134.00
Option:				
836.535	Spare battery			1.90

Lever-type digital test indicator

Lever-type digital test indicator with tolerance judgement. Suitable for measurements in both directions. Equipped with three dovetail mountings.

- Measuring range: up to 0.5 mm.
- Resolution: 0.001 mm.
- Accuracy: ± 0.02 mm.
- mm/inch conversion.
- On/off switch.
- Reset.
- Measuring force: ≤ 0.6 N.
- With dovetail joint and clamping stems $\varnothing 6$ and $\varnothing 8$ mm.
- Ruby stylus tip: $\varnothing 2$ mm.



- 230° adjustable measuring insert.
- Adjustable tolerance limits.
- Power supply: 1 battery type V357.



Item No.	Measuring range/mm	Resolution mm	Insert length/mm	Price EUR
907.574	0.5	0.001	17	166.00
Options:				
836.535	Spare battery			1.90
907.769	Spare stylus tip			12.50

Lever-type test indicators

- Measuring range: up to 0.8 mm.
- Graduation: 0.01 or 0.002 mm.
- With dovetail joint and clamping stems $\varnothing 6$ and $\varnothing 8$ mm.
- Dial diameter: 40 mm.

- Rotatable dial.
- Stylus tip: $\varnothing 2$ mm.
- Delivery with an inspection report.

Item No.	Measuring range/mm	Graduation mm	Scale numbering	Insert length/mm	Price EUR
907.941	0.8	0.01	0-40-0	19	31.70
907.942	0.2	0.002	0-100-0	13	57.00
Options:					
909.114	Spare stylus tip for 907.941				7.60
909.115	Spare stylus tip for 907.942				7.60



907.941



Peacock lever-type dial test indicators

- Measuring range: up to 1 mm.
- Graduation: 0.01, 0.002 or 0.001 mm.
- With dovetail joint and clamping stem $\phi 6$ mm.
- Measuring force: <0.3 N.
- Tungsten carbide stylus tip: $\phi 2$ mm.
- Insert thread: M1.7.

Inserts for lever-type dial test indicators

Item No.	Effective length (EL)/mm	Ball ϕ /mm	Price EUR
For 855.601:			
859.016	17.74	2	5.80
859.152	17.74	1	11.60
859.151	17.74	0.8	11.60
859.290	17.74	0.5	58.00
For 855.602:			
859.126	39.00	2	9.30
859.291	39.00	1	13.90
859.292	39.00	0.8	13.90
859.293	39.00	0.5	58.00
For 855.603, 855.605 and 855.606:			
859.200	14.18	2	7.00
859.294	14.18	1	11.60
859.295	14.18	0.8	11.60
859.296	14.18	0.5	58.00
For 855.604:			
859.259	8.13	2	7.00
859.297	8.13	1	11.60
859.298	8.13	0.8	11.60
859.299	8.13	0.5	58.00
For 855.611:			
859.464	19.24	2	5.80
859.465	19.24	1	11.60
859.466	19.24	0.8	11.60
859.467	19.24	0.5	58.00

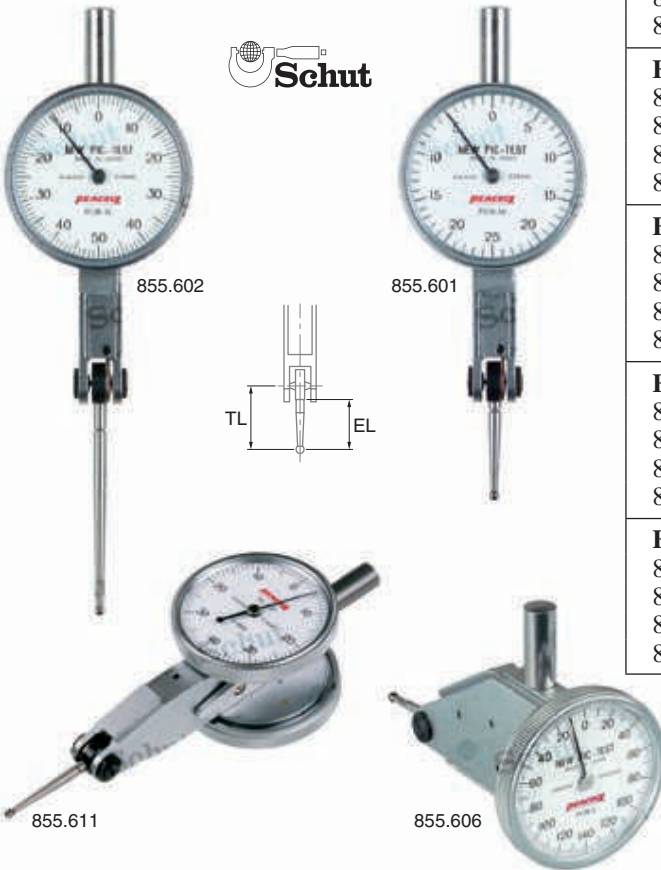

Item No.	Measuring range/mm	Graduation mm	Dial ϕ /mm	Scale numbering	Insert	Total insert length (TL)/mm	Price EUR
Horizontal:							
855.601	0.5	0.01	35	0-25-0	859.016	21.3	81.00
855.602	1	0.01	35	0-50-0	859.126	42.8	95.00
855.603	0.28	0.002	35	0-140-0	859.200	17.8	95.00
855.604	0.14	0.001	30	0-70-0	859.259	11.7	101.00
855.605	0.5	0.01	35	0-25-0	859.200	17.8	101.00
Perpendicular:							
855.606	0.28	0.002	35	0-140-0	859.200	17.8	114.00
855.611	0.8	0.01	35	0-40-0	859.464	21.8	166.00

Mitutoyo lever-type dial test indicators 0.01 mm

These dial test indicators are able to measure in both directions without having to switch direction.

- Measuring range: up to 1 mm.
- Graduation: 0.01 mm.
- With dovetail joint and clamping stem $\varnothing 8$ mm.
- Dial diameter: $\varnothing 40$ mm.
- Tungsten carbide stylus tip: $\varnothing 2$ mm.
- Insert thread: M1.7 (optional inserts on request).
- Jewel beared clockwork.
- Antimagnetic.
- Delivery in a case with a clamping stem.
- Various different models available.



Inserts

Item No.	Ball \varnothing /mm	Price EUR
For 513.424/426:		
137.557 ¹	2	14.00
290.654 ²	0.5	21.00
190.653 ²	0.7	17.00
137.558 ¹	1	9.00
137.559 ¹	3	9.00
For 513.414:		
131.324 ¹	2	6.00
131.316 ¹	1	6.00
For 513.403/454/484:		
103.006 ¹	2	14.00
290.549 ²	0.5	21.00
290.550 ²	0.7	17.00
103.013 ¹	1	9.00
210.201 ³	2	24.00
103.014 ¹	3	9.00
For 513.415:		
136.013 ¹	2	11.00
290.656 ²	0.5	23.00
290.655 ²	0.7	20.00
136.235 ¹	1	9.00
211.211 ³	2	24.00
136.236 ¹	3	9.00

¹ Tungsten carbide.

² Steel.

³ Ruby.



Item No.	Measuring range/mm	Accuracy f_{ges} /mm	Hysteresis mm	Measuring force/N	Scale numbering	Insert	Insert length (L1/L2)/mm	Price EUR
Horizontal model:								
513.424	0.5	0.006	0.004	≤ 0.3	0-25-0	137.557	22.2/18.7	135.00
513.426	1.5	0.016	0.005	≤ 0.4	0-25-0	137.557	22.2/18.7	142.00
513.414	0.5	0.010	0.005	≤ 0.2	0-25-0	131.324	37.4/33.9	138.00
513.403	0.8	0.009	0.004	≤ 0.3	0-40-0	103.006	20.9/17.4	84.00
513.415	1	0.010	0.005	≤ 0.2	0-50-0	136.013	44.5/41.0	138.00
Vertical model:								
513.454	0.8	0.009	0.004	≤ 0.3	0-40-0	103.006	20.9/17.4	102.00
Parallel model:								
513.484	0.8	0.009	0.004	≤ 0.3	0-40-0	103.006	20.9/17.4	119.00

Mitutoyo lever-type dial test indicators 0.001 and 0.002 mm

These dial test indicators are able to measure in both directions without having to switch direction.

- Measuring range: up to 0.6 mm.
- Graduation: 513.401: 0.001 mm,
513.465/406/425: 0.002 mm.
- With dovetail joint and clamping stem \varnothing 8 mm.
- Dial diameter: 513.465: \varnothing 29 mm,
513.401/406/425: \varnothing 40 mm.
- Tungsten carbide stylus tip: \varnothing 2 mm.
- Insert thread: M1.7 (optional inserts on request).
- Jewel beared clockwork.
- Antimagnetic.
- Delivery in a case with a clamping stem.
- Various different models available.

NEW



513.401

Inserts

Item No.	Ball \varnothing /mm	Price EUR
For 513.465/406/425:		
103.011 ¹	2	14.00
131.314 ¹	1	4.00
131.315 ¹	3	4.00
210.068 ²	2	14.80
For 513.401:		
103.010 ¹	2	14.00
290.547 ³	0.5	21.00
290.548 ³	0.7	17.00
103.017 ¹	1	9.00
210.209 ²	2	24.00
103.018 ¹	3	9.00

¹ Tungsten carbide.

² Ruby.

³ Steel.

Item No.	Measuring range/mm	Accuracy f_{ges} /mm	Hysteresis mm	Measuring force/N	Scale numbering	Insert	Insert length (L1/L2)/mm	Price EUR
513.401	0.14	0.004	0.003	≤ 0.3	0-70-0	103.010	14.7/11.2	149.00
513.465	0.2	0.004	0.003	≤ 0.3	0-100-0	103.011	18.7/15.2	145.00
513.406	0.2	0.004	0.003	≤ 0.3	0-100-0	103.011	18.7/15.2	109.00
513.425	0.6	0.007	0.004	≤ 0.4	0-100-0	103.011	18.7/15.2	149.00

Mitutoyo lever-type dial test indicator sets

The set consists of:

- lever-type dial test indicator,
- insert with hard chrome plated tip \varnothing 1 mm,
- insert with tungsten carbide tip \varnothing 2 mm,
- insert with hard chrome plated tip \varnothing 3 mm,
- union nut,
- clamping stem \varnothing 4 mm,
- clamping stem \varnothing 8 mm,
- universal rotatable holder,
- clamping stem for height gauge
(9 x 9 x 100 mm),
- case.

NEW



513.404

Item No.	Description	Price EUR
513.404	Lever-type dial test indicator 0.8 mm with several accessories	115.00
513.408	Lever-type dial test indicator 0.2 mm with several accessories	142.00



TESA lever-type dial test indicators

- Measuring range: up to 2 mm.
- Graduation: 0.02, 0.01 or 0.002 mm.
- With dovetail joint.
- Tungsten carbide (Tesastast) or ruby (Swisstast) stylus tip, $\varnothing 2$ mm.
- Insert thread: M1.4.
- DIN 2270.
- Delivery with a clamping stem (780.172) and a declaration of conformity.



780.143-
780.148



780.149-
780.151



780.152-
780.154



781.466-
781.467

Item No.	Measuring range/mm	Graduation mm	Dial \varnothing /mm	Scale numbering	Insert length/mm	Price EUR
Tesastast, horizontal:						
780.143	0.8	0.01	28	0-0.4-0	12.53	113.00
780.144	0.8	0.01	38	0-0.4-0	12.53	127.00
780.145	0.5	0.01	28	0-0.25-0	36.53	147.00
780.146	0.5	0.01	38	0-0.25-0	36.53	162.00
780.147	0.2	0.002	28	0-100-0	12.53	133.00
780.148	0.2	0.002	38	0-100-0	12.53	147.00
Tesastast, lateral:						
780.149	0.8	0.01	28	0-0.4-0	12.53	227.00
780.150	2.0	0.02	38	0-1.0-0	36.53	250.00
780.151	0.2	0.002	28	0-100-0	12.53	262.00
Tesastast, perpendicular:						
780.152	0.8	0.01	28	0-0.4-0	12.53	241.00
780.153	0.5	0.01	28	0-0.25-0	36.53	339.00
780.154	0.2	0.002	38	0-100-0	12.53	309.00
Swisstast, horizontal:						
781.466	0.8	0.01	28	0-0.4-0	12.53	127.00
781.467	0.2	0.002	38	0-100-0	12.53	162.00

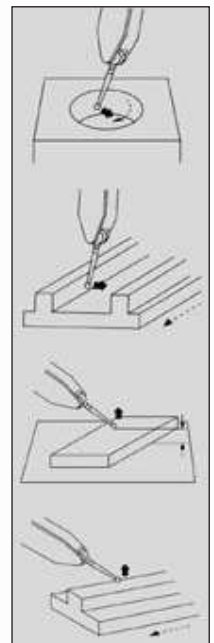

Interapid lever-type dial test indicators

- Measuring range: up to 1.6 mm.
- Graduation: 0.01 or 0.002 mm.
- Angle between insert and workpiece for true reading: 12°.
- With dovetail joint and clamping stem $\varnothing 4$ mm.
- Hardened steel stylus tip: $\varnothing 2$ mm.
- Insert thread: M1.7 (optional inserts on request).
- Delivery in a case with a declaration of conformity.

The sets consist of:

- dial test indicator,
- rectangular holder with clamp,
- reducing sleeve,
- swivel holder,
- key,
- case.



781.520



781.524



781.526

Item No.	Measuring range/mm	Graduation mm	Dial \varnothing /mm	Scale numbering	Insert length/mm	Price EUR	Item No.	Price EUR
Horizontal:							In a set:	
781.520	1.6	0.01	37.5	0-40-0	16.5	231.00	781.526	320.00
781.521	1.6	0.01	30	0-40-0	16.5	230.00	781.527	315.00
781.522	0.4	0.002	37.5	0-10-0	15.2	283.00	781.528	370.00
781.523	0.4	0.002	30	0-10-0	15.2	280.00	781.529	364.00
Perpendicular:								
781.524	1.6	0.01	37.5	0-40-0	16.5	259.00		
781.525	1.6	0.01	30	0-40-0	16.5	252.00		

Käfer lever-type dial test indicators

Käfer lever-type dial test indicators have a very high accuracy because of the ruby ball bearing. The direction of the rotation is independent of the measuring direction. Equipped with three dovetail mountings. Are standard delivered with a clamping stem $\varnothing 8$ mm.

- Measuring range: up to 0.8 mm.
- Graduation: 0.01 or 0.002 mm.
- With dovetail joint and clamping stem $\varnothing 8$ mm.
- Rotatable dial.
- Tungsten carbide stylus tip: $\varnothing 2$ mm.
- Insert thread: M1.6
(optional inserts on request).
- 240° adjustable measuring insert.
- Ruby ball bearing.
- DIN 2270.
- Delivery in a case incl. key.
- Various different models available.



Item No.	Measuring range/mm	Graduation mm	Dial \varnothing /mm	Scale numbering	Insert length/mm	Price EUR
852.361	0.8	0.01	32	0-40-0	12	72.00
852.362	0.5	0.01	32	0-25-0	35	97.00
852.363	0.2	0.002	40	0-100-0	12	90.00

Käfer saw tooth indicator

By placing the indicator on the saw blade you can easily measure the flatness of the blade, enabling you to saw very precisely. With the indicator you can also measure the height difference between the saw blade and the tooth. This principal of differential measuring of thickness or heights is not only suited for saw blades, but has many other applications.

Because the indicator has a two-sided read-out, it is usable for left- as well as right-handers.

- Measuring range: 0-2 mm.
- Graduation: 0.05 mm.
- Rotatable dial.
- Adjustable tolerance marker.



Item No.	Description	Price EUR
852.364	Saw tooth indicator	61.00

TESA dial test indicator accessories

Item No.	Description	Price EUR
780.171	① Fixing shaft $\phi 4 \times 12$ mm	27.00
780.172	② Fixing shaft $\phi 8 \times 12$ mm	16.00
780.173	③ Cylindrical fixing shaft $\phi 8 \times 80$ mm, clamping shaft $\phi 5.6$ mm	22.00
780.175	④ Swivelling holder $\phi 8 \times 25$ mm	44.00
780.176	⑤ Swivelling holder $\phi 8 \times 90$ mm	47.00
780.177	⑥ Angle holder $\phi 8 \times 25$ mm, clamping shaft $\phi 8$ mm	46.00
780.178	⑦ Centering support $\phi 8 \times 25$ mm, clamping shaft $\phi 4$ mm	107.00
780.208	⑧ Double fixing clamp $\phi 5.6 / \phi 9.5$ mm, with dovetail clamp	25.00
782.787	⑨ Swivelling holder $\phi 8 \times 125$ mm, with fine adjustment	87.00
782.590	⑩ Fixing shaft $\phi 6 \times 12$ mm	25.00
855.600	⑪ Fixing shaft $9 \times 11 \times 106$ mm complete with dovetail clamp and clamping shaft $\phi 6$ mm	27.20



Measuring inserts for lever-type dial test indicators

Inserts for TESA lever-type dial test indicators, with tungsten carbide* tip and thread M1.4

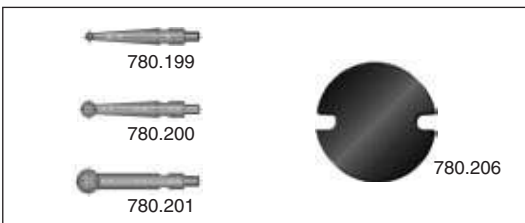

Item No.	Length/mm	ϕ /mm	Price EUR
780.199	12.53	1	12.00
780.200	12.53	2	12.00
780.201	12.53	3	12.00
780.202	36.53	1	28.00
780.203	36.53	2	28.00
780.204	36.53	3	29.00
780.206	Key		2.20

* Also available with ruby tip.

Accessories dial indicators/dial test indicators

Item No.	Description	Price EUR
909.433	Centering support $\varnothing 8 \times 25$ mm, holder $\varnothing 4$ mm	16.40
909.434	Rectangular fixing shaft $12 \times 6 \times 76$ mm, holder $\varnothing 4/\varnothing 8$ mm and dovetail clamp	11.50
909.435	Rectangular fixing shaft $12 \times 6 \times 76$ mm, holder $\varnothing 6/\varnothing 8$ mm and dovetail clamp	11.50
909.436	Rectangular fixing shaft $9 \times 9 \times 76$ mm, holder $\varnothing 4/\varnothing 8$ mm and dovetail clamp	11.50
909.437	Rectangular fixing shaft $9 \times 9 \times 76$ mm, holder $\varnothing 6/\varnothing 8$ mm and dovetail clamp	11.50
909.438	Round, swivelling fixing shaft $\varnothing 6 \times 70$ mm, holder with dovetail clamp	11.50
909.439	Round, swivelling fixing shaft $\varnothing 8 \times 70$ mm, holder with dovetail clamp	11.50



Reducer



837.190



Item No.	Thread	Price EUR
781.819	$\varnothing 8 \rightarrow 4$ mm	16.00
837.190	$\varnothing 8 \rightarrow 6$ mm	0.70

Center-accessory

Small magnetic dial indicator stand which, in combination with a lever, could also be used as center-accessory to align bores in workpieces. For use in combination with a machine center.

- Permanent magnet $\varnothing 27$ mm.
- Universal pivot with dovetail clamp.
- Delivery incl. cylindrical support $\varnothing 9.5$ mm for insert in the collet chuck of a machine center.



Item No.	Description	Price EUR
781.997	Center-accessory	175.00

Centering device

Convenient tool to find and set up the position of a workpiece on vertical and horizontal machines. It can also be used to determine the position of a workpiece when the spindle is rotated by hand or automatic. Easy read-out from stationary dial indicator. Instrument with compact dimensions.

- Max. range of use: 300 mm.
- Scale read-out per rotation: 0-3 mm.
- Graduation: 0.01 mm.
- Centering inside and outside with various probes.
- 3 straight and 3 bended probes included.
- Center feeler included.
- Spindle rotating speed max. 800 rpm.
- Compact dimensions.
- For horizontal and vertical use suitable.
- Clamping stem: \varnothing 10 mm.
- Delivery in a case.



Item No.	Description	Price EUR
907.451	Centering device	116.00
Option:		
907.445	Probe set (7 pieces)	25.20



3D probes for centering and measuring

For easy and with high accurate setting the reference point of workpiece in all three axes (X, Y and Z), vertically and horizontally.

- Measuring range: max. ± 2 mm (rupture point in probe).
- Analog: graduation 0.01 mm, digital: resolution 0.001 mm.
- Clamping stem: $\varnothing 20$ mm.
- Insert length 25 mm, stylus tip $\varnothing 4$ mm (insert length 65 mm and diameter 8 mm optional).
- mm/inch conversion (only 853.822).
- Digit height: 8.5 mm (only 853.822).
- Isolation between insert and insert thread; for use on all machining centres and EDM machines.
- Insert thread: M3.
- Protection:
analog: IP67,
digital: IP64.



Item No.	Description	Accuracy mm	Repeatability mm	Price EUR
853.821	Analog 3D probe	± 0.01	0.01	279.00
853.822	Digital 3D probe	± 0.005	0.001	496.00
Options:				
495.157	Spare battery			0.50
853.823	Spare insert 25 mm, tip diameter 4 mm			25.20
853.824	Spare insert 65 mm, tip diameter 8 mm			42.00

Edge finders

Edge finders for both stationary and rotating use. As soon as the workpiece is touched by the ballprobe the all around visible LED will light up due to galvanic contact. The ballprobe is held in place by a spring. When the pressure on the tip becomes too large the ball wil flip away sideways. The edge finders are also available with additional sound signal for extra working comfort.

- Concentricity: < 0.01 mm.
- Diameter ballprobe: 10 mm.
- Delivery in a case.
- Power supply:
907.456/460: 2 batteries type V357,
907.454/458: 1 battery type 23A.



Item No.	Clamping stem \varnothing /mm	Length mm	Price EUR
907.454	20	162	49.00
907.456	20	100	44.00
With sound signal:			
907.458	20	162	63.00
907.460	20	100	54.00
Options:			
836.535	Spare battery (2 needed)		1.90
497.931	Spare battery		1.00



Edge finders

Rotating edge finders for accurate edge location.

- Resolution: 0.005 mm.
- Repeatability: 0.005 mm.
- Range of use: 400 - 600 rpm.
- Hardness TiN measuring face: 2200 HV.



Item No.	Clamping stem \varnothing /mm	Probe \varnothing /mm	Material (measuring face)	Price EUR
909.360	8	10	steel	17.50
909.361	10	10	steel	17.50
909.362	8	4 and 10	steel	18.90
909.363	10	4 and 10	steel	18.90
909.364	6	6	steel	18.90
909.365	10	10	steel + ceramic	54.00
909.366	10	10	steel + TiN	31.60
909.367	10	4 and 10	steel + TiN	31.60
Options:				
909.368	Spring for 909.360/362			2.10
909.369	Spring for 909.364			3.00
909.359	Spring for 909.365			3.00
909.349	Spring for 909.361/363/366/367			3.00

Z-axis setting gauge

For easy presetting the Z-axis with a tool, with or without in combination with parallel blocks to set a specific height. As soon as the tool touches the setting gauge (with floating top) the built-in red LED illumination will light up. After this the axis will move in opposite direction until the lamp turns off, this is the turning point, and so the setting gauge, to determine the accuracy.

- Repeatability: 0.01 mm.
- With magnetic base.
- Galvanic contact principle.



Item No.	Description	Price EUR
908.804	Z-axis setting gauge	161.00
Option:		
498.823	Spare battery (2 needed)	1.40

- Dimensions: $\varnothing 54 \times 50$ mm (precise height to determine with external measuring instrument).
- Weight: 450 g.
- Power supply: 2 batteries type V389.



Z-axis setting gauge

For easy presetting the Z-axis with a tool, with or without in combination with parallel blocks to set a specific height.

- Graduation: 0.01 mm.
- Repeatability: 0.02 mm.
- With magnetic base.
- Diameter dial indicator: $\varnothing 35$ mm.



- Height: 50 mm (precise height to determine with external measuring instrument).
- Weight: 654 g.
- Delivery with reference pin for insert in tool holder.



Item No.	Description	Price EUR
909.460	Z-axis setting gauge	115.00

Tool presetters

Cost effective solution as an additional setup directly next to your machine, for setting up and accurately measuring length and diameter of milling, turning and drilling tools. Increase your machine up-time through rapid manual movement with release/hook-up button and fine adjustment using the hand wheel (only 837.928/916).

- Resolution: 0.01 mm.
- mm/inch conversion.
- RS232C data output.
- On/off switch.
- Preset.
- Interchangeable rotating chuck.
- Delivery incl. rotating chuck ISO 40.
- Conforms to factory standard.
- Delivery in a wooden case.
- Power supply: 2 batteries type CR2032.
- Various models with extended functionality available on request.



Options

Item No.	Type	Price EUR
Rotating chuck:		
837.930	ISO 30	293.00
837.917	ISO 40	293.00
837.931	ISO 45	293.00
837.932	ISO 50	293.00
837.933	HSK 40	293.00
837.934	HSK 50	293.00
837.935	HSK 63	293.00
837.936	VDI 40	293.00
837.937	DLBH-SKF 63	293.00
ISO reductions:		
837.938	50-45	247.00
837.939	50-40	247.00
837.940	50-30	247.00
837.941	40-30	247.00
837.942	50HSK40	303.00
837.943	50HSK50	303.00
837.944	50HSK63	303.00
Spare battery:		
495.157	CR2032	0.50

Item No.	Measuring range/mm		Dimensions	Weight	Price
	X-axis	Z-axis	l x w x h/mm	kg	EUR
Without fine adjustment:					
837.929	160(ø 320)	320	420 x 150 x 755	20	2,530.00
With hand wheel for fine adjustment:					
837.928	160(ø 320)	320	584 x 150 x 520	25	3,540.00
837.916	260(ø 520)	520	684 x 150 x 848	30	4,240.00

Electronic probe and read-out unit

Inductive, absolute electronic probe for precision measurements. The measured value is displayed both digitally and digital-analogue. The 2-axes model of the read-out unit has an addition function for the probes.

Electronic probe

- Measuring range: ± 1 mm.
- Resolution: $0.1 \mu\text{m}$.
- Accuracy: $\pm 3.5 \mu\text{m}$.
- Measuring force: 1.2 N.
- Clamping stem: $\varnothing 8$ mm.



Digital read-out units

- Measuring range: 2 mm.
- Resolution: $0.1 \mu\text{m}$.
- Digital-analogue graduation: 100/20/10/2/1/0.2/0.1 μm .
Range: $\pm 20\times$ graduation.
- $\mu\text{m}/\text{inch}$ conversion.
- ABS/INC switchable.
- On/off switch.
- Reset/preset.
- Hold function.
- Addition function: $\pm A \pm B$ (only 907.858).
- Adjustable tolerance limits.
- Power supply: 3 batteries type AA.



907.791



907.790



Item No.	Description	Price EUR
907.790	Electronic probe	191.00
907.791	Read-out unit, 1 axis	492.00
907.858	Read-out unit, 2 axes	559.00
Option:		
495.111	Spare battery (3 needed)	0.40



TESA TWIN-T10 display unit for inductive probe

Portable electronic display unit for TESA inductive probe with a very long battery operating time (up to 400 hours). The function keys can be operated separately and the soft rubber casing makes the TWIN-T10 very robust and easy to hold.

The large display with a high contrast and the design of the detailed segmentation of the analog scale (5-fold zoom function) makes it possible to visualize very precise movements and slight variations in form or to detect the reversal point. The TWIN-T10 features max, min, max-min and tolerance functions. The TWIN-T10 is very suitable for the evaluation of straightness, run-out, form or geometry during fine adjustment, alignment or fitting of mechanical parts.

The probe is automatically recognized. In the display 7 different measuring ranges can be set and an automatic setting. With the calibration function it is possible to tune the TWIN-T10 in combination with the connected probe, or with a dummy probe. With the TLC-USB cable and the TLC-TWIN-Cap (for wireless data transfer) bidirectional communication is possible with the PC. Digimatic data output is also possible with the TLC-Digimatic cable.

- 7 measuring ranges: ± 5 mm, ± 2 mm, ± 500 μ m, ± 200 μ m, ± 50 μ m, ± 20 μ m, ± 5 μ m and an automatic setting.
- Digital and digital-analog read-out.
- Resolution: 1 μ m or 0.1 μ m.
- 1 probe input.
- Measure with or without tolerance limits; Go/NoGo indication on display.
- Offset function: within 200 μ m directly set to zero.
- Memory for min., max. and max-min. value.
- mm/inch conversion.
- Frequency limit: 10 Hz (relative to the input signal).
- Response time: ≤ 100 ms.
- Calibration with gauge blocks or dummy probe.
- Bidirectional data transfer.
- RS232C data output.
- On/off switch.
- Automatic switch-off.
- Key lock function.
- Reversible measuring direction.
- Operating temperature: 10 to 40°C.
- Autonomy: up to 400 hours.
- Dimensions: 170 x 100 x 38 mm.
- Protection: IP63 (except connections for probe and switch).
- DIN 32876-1.
- Delivery with batteries and a declaration of conformity.
- Power supply: 4 batteries type AA.



783.314



783.468

Options:

Item No.	Description	Price EUR
783.468	TESA TWIN-T10	1,217.00

Item No.	Description	Price EUR
495.111	Spare battery (4 needed)	0.40
780.652	GT31 probe	763.00
780.951	Hand switch 1.8 m	93.00
780.952	Foot switch 1.8 m	243.00
783.301	TESA Link Connector USB	118.00
783.302	TESA Link Connector Digimatic	170.00
783.303	TESA Link Connector TWIN-Cap	159.00
783.314	TESA TWIN Station	402.00
783.037	DATA-Direct software for data acquisition	390.00
783.038	STAT-Express for statistical analysis	920.00
779.982	Back support with centered lug	43.00
779.981	Back support with off-centered lug	73.00



Tesatronic TT20, TT60 and TT80

The TT20, TT60 and TT80 are provided with two probe inputs for single, sum or difference measurements. The instrument automatically recognizes the type of the connected probe and sets the measuring range. This increases the ease of operation and ensures the reliability of the measurement.

The combination of the digital and digital-analog display simplifies the reading of the correct measurement value considerably.

- Two probe inputs.
- Automatic display setting of the probes used (only applies to TESA probes).
- Digital (6 digits) and digital-analog read-out.
- 7 measuring ranges: $\pm 5000 \mu\text{m}$ - $\pm 5 \mu\text{m}$ and an automatic setting.
- Resolution: $0.1 \mu\text{m}$.
- Opto-RS232C data output.
- Hold function.
- Addition function: $\pm A \pm B$.
- Measure with or without tolerance limits.
- LEDs for classification: green=Go, yellow=process, red=NoGo.
- Relays output of the classification.
- Switch over polarity, choice between internal and external measurement.
- Memory of the setup when switching off.
- Reference point to be adjusted per channel.
- Stackable casing.
- Dimensions: 255 x 235 x 120 mm.
- Protection: IP54 (front).
- DIN 32876 T1.
- Delivery with AC adapter and a declaration of conformity.
- Power supply: AC adapter (230 Vac - 7.3 Vdc).

Only TT60

- Memory for min., max., difference and average between max. and min. value.
- Dynamic measuring (more than 100 measurements per second).
- Output for 5, 10, 20 or 40 "Go" measurements.
- Analog output $\pm 2 \text{ V}$ or $\pm 10 \text{ V}$ to connect a recorder or a separate display.

Only TT80

- 9 measuring ranges: $\pm 5000 \mu\text{m}$ - $\pm 0.5 \mu\text{m}$.
- Resolution: $0.01 \mu\text{m}$.



781.885



781.884



Item No.	Type/description	Price EUR
781.884	Tesatronic TT20	1,390.00
781.885	Tesatronic TT60	1,930.00
782.367	Tesatronic TT80	2,317.00
Option:		
781.999	Opto-RS232C cable 9p, bidirectional (2 m)	131.00

Display-unit for measuring probes

Robust, splashproof display-unit, machined from a solid aluminum block, that can be employed in both simple and complex measurements. Both analog and digital display of up to 32 dimensions simultaneously, with (green, yellow, red) tolerance assessment per dimension. The display-unit is universally applicable due to its compatibility with many probe brands, and powerful due to its ability to display up to 32 dimensions at the same time and its trigonometrical-, statistical and PLC functions. The device is very suitable for efficient quality control without the need for a PC in the workspace.

- 7" colour touch screen.
- Up to 99 probes can be connected.
- Display up to 32 dimensions.
- Store up to 128 measurement configurations.
- Memory for max, min, difference, average.
- Dynamic or static measurements.
- mm/inch conversion.
- ABS/INC switchable.
- RS232C input and output.
- Hold function.
- Statistical functions, e.g. histograms with Gauss curve, Pareto graph, q-q plot, CM, CMK.
- Configuration protection by password.
- Multilingual software, e.g. English, French, German, Dutch.

- I/O via Modbus TCP module.
- Dimensions: 200 x 151.6 x 143 mm.
- Storage of measuring data.
- Power supply: AC adapter.
- Modules can be mounted on a standard DIN rail.

Connections:

- Footswitch.
- USB port for USB stick.
- Ethernet (ASCII/Modbus TCP).
- RS232 (ASCII/Modbus RTU).
- M-Bus input for probes.



Item No.	Type/description	Price EUR
857.880	Display-unit	
Options:		
857.881 ¹	Module for 8 TESA probes	
857.882 ¹	Module for 2 Magnescale probes	
857.883 ¹	Module for 4 Magnescale probes	
857.884 ²	Power module	
348.287	Connecting cable display-unit/probe module (3 m)	

¹ Modules for other probes on request, e.g. Heidenhain, Sylvac and Mitutoyo.

² For applications using more than 30 analog TESA probes, or 4 Magnescale probes on 1 display-unit.



TESA analog and digital probes

- Measuring range: ± 1.5 , ± 2 or ± 5 mm.
- Protection: IP65.
- Other models, ranges and voltages available on request.

TESA analog DC probes

Probes that produce a linear voltage proportional to displacement that can be connected to AD converters in a PC or to PLCs and X-t plotters.

The probe consists of two parts that are connected by a cable (2 m):

- a conventional analog probe (diameter 8 mm),
- the electronics module that converts the signal to DC.

- Accuracy: from $(0.2 + 3.5L^2) \mu\text{m}$ (L in mm).
- Signal output: 782.977/978: ± 2 Vdc,
782.979/980: ± 5 Vdc.
- Power supply: ± 15 Vdc.

TESA digital USB probes

USB probes are easy to connect, using plug & play and without using interface boards. High accuracy guaranteed within the complete measuring range.

- Compatible with software Data-Direct and Stat-Express.
- Simple link with for example Excel files.



Item No.	Type	Measuring range/mm	Price EUR
Analog DC probes:			
782.977	GTL21DC	± 2	722.00
782.978	GTL22DC	± 2	735.00
782.979	GT61DC	± 5	855.00
782.980	GT62DC	± 5	873.00
Digital USB probes:			
783.097	GTL21 USB	± 2	587.00
783.098	GTL22 USB	± 2	601.00
783.226	GTL222 USB	± 1.5	713.00
783.099	GT61 USB	± 5	725.00
783.100	GT62 USB	± 5	737.00

Type	Protection	Measuring force/N	Repeatability μm	Accuracy μm (L in mm)	Max. travel/mm	Cable exit	Probe movement
GTL21DC	IP65	0.63	0.1	$0.2 + 3.5L^2$	4.3	axial	spring, extend
GTL22DC	IP65	0.63	0.1	$0.2 + 3.5L^2$	4.3	square	vacuum, retract
GT61DC	IP65	0.9	0.1	$1 + 4L$	10.3	axial	spring, extend
GT62DC	IP65	0.9	0.1	$1 + 4L$	10.3	square	vacuum, retract
GTL21 USB	IP65	0.63	0.1	$0.4 + 0.8L$	4.3	axial	spring, extend
GTL22 USB	IP65	0.63	0.1	$0.4 + 0.8L$	4.3	square	vacuum, retract
GTL222 USB	IP65	1.2	0.1	$0.4 + 0.8L$	3.1	square	air pressure
GT61 USB	IP65	0.9	0.24	$0.8 + 0.8L$	10.3	axial	spring, extend
GT62 USB	IP65	0.9	0.24	$0.8 + 0.8L$	10.3	square	vacuum, retract

TESA wireless probes

- Measuring range: ± 1.5 , ± 2 or ± 5 mm.
- Clamping stem: $\varnothing 8$ mm.
- Protection: IP54.



Item No.	Type	Measuring range/mm	Price EUR
783.309	GTL21W	± 2	816.00
783.310	GTL212W	± 1.5	923.00
783.311	GT61W	± 5	862.00
783.312	GT612W	± 5	975.00
Option:			
783.316	Charger for TESA wireless probe		59.00

Type	Measuring force/N	Repeatability μm	Maximum inaccuracy/ μm^*	Probe movement
GTL21W	0.63	<0.10	$0.4+0.8L$	spring, extend
GTL212W	1.20	<0.10	$0.4+0.8L$	air pressure
GT61W	0.90	<0.24	$0.8+0.8L$	spring, extend
GT612W	2.00	<0.24	$0.8+0.8L$	air pressure

* In combination with TWIN Station.

TESA analog probes

For years, TESA measuring probes have been used in both complex and simple measuring systems. The top quality and absolute reliability of these probes is reason enough to use TESA probes again and again.

- Sensitivity: 73.75 mV/V/mm (GT61 and GT62: 29.5 mV/V/mm).

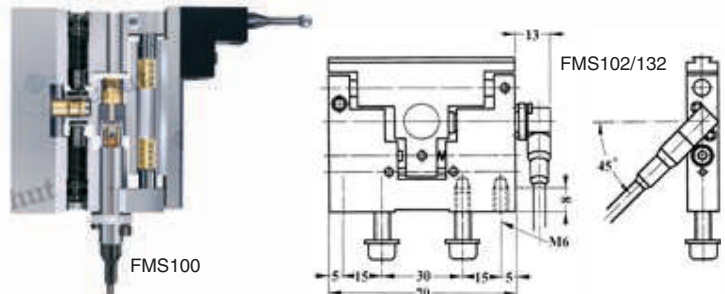
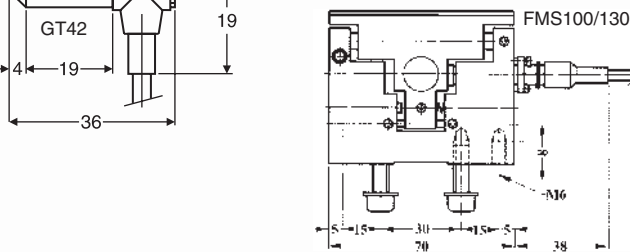
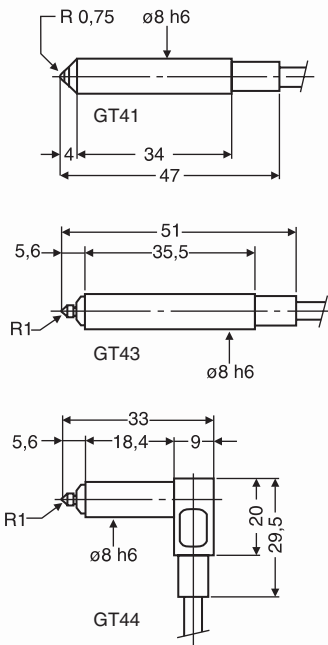
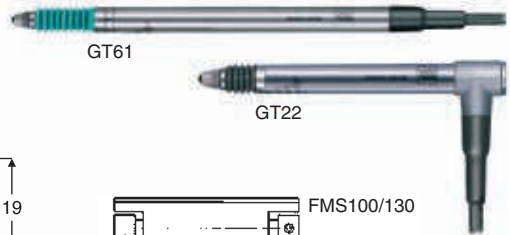

TESA analog probes (continued)

The most popular half-bridge probes, delivered calibrated, are noted in the following table. For more information, also on LVDT probes, please refer to the comprehensive TESA catalog.

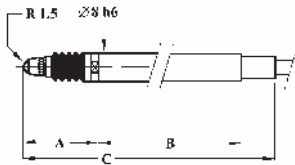

GT21(HP)/GT61

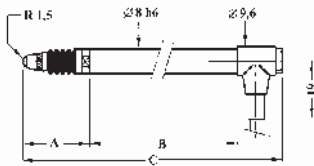

GT22(2)(HP)/GT62(2)

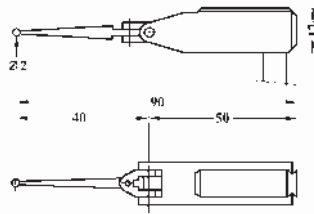

GT31



GT21

Item No.	Type	Measuring range/mm	Dimensions/mm			Price EUR
			A	B	C	
780.654	GT21	± 1	20.5	61.5	92	338.00
780.687	GT21HP	± 0.2	20.5	61.5	92	645.00
780.662	GT22	± 1	20.5	47	81.5	349.00
780.673	GT22HP	± 0.2	20.5	47	81.5	661.00
780.692	GT61	± 5	29.5	81	120	469.00
780.693	GT62	± 5	29.5	67.2	110.7	481.00
783.076	612-A	± 5	29.5	67.2	110.7	478.00
781.945	GT622	± 5	29.5	67.2	110.7	531.00
780.667	GT41	± 0.3	–	–	–	479.00
780.668	GT42	± 0.3	–	–	–	499.00
780.686	GT43	± 1	–	–	–	425.00
780.670	GT44	± 1	–	–	–	417.00
780.652	GT31	± 0.3	–	–	–	763.00
780.672	FMS100	± 2	–	–	–	663.00
780.679	FMS102	± 2	–	–	–	748.00
781.946	FMS130	± 2.9	–	–	–	750.00
781.947	FMS132	± 2.9	–	–	–	852.00
782.328	Set (10 pcs.) GT21					2,728.00
782.329	Set (10 pcs.) GT22					2,904.00
Options:						
783.225	DIN/USB adapter for analog probes with measuring range ± 2 mm					383.00
783.284	DIN/USB adapter for analog probes with measuring range ± 5 mm					383.00

Type	IEC 60529	Measuring force/N	Repeatability µm	Maximum inaccuracy/µm	Max. travel/mm	Cable exit	Probe movement
GT21	IP65	0.63	0.01	0.2 + 3L ³	4.3	axial	spring, extend
GT21HP	IP64	0.63	0.01	0.07+ 0.4L	4.3	axial	spring, extend
GT22	IP65	0.63	0.01	0.2 + 3L ³	4.3	square	vacuum, retract
GT22HP	IP64	0.63	0.01	0.07+ 0.4L	4.3	square	vacuum, retract
GT61	IP65	0.9	0.05	1 + 4L	10.3	axial	spring, extend
GT62	IP65	0.9	0.05	1 + 4L	10.3	square	vacuum, retract
612-A ¹	IP50	1.0	0.05	1 + 4L	10.3	axial	air pressure
GT622	IP65	2.0	0.05	1 + 4L	10.3	square	1.1 bar, extend
GT41	IP65	0.63	0.01	0.2 + 5L ²	0.7	axial	spring, extend
GT42	IP65	0.63	0.01	0.2 + 5L ²	0.7	square	vacuum, retract
GT43	IP65	0.4	0.1	0.2 + 5L ²	2.1	axial	spring, extend
GT44	IP65	0.4	0.1	0.2 + 5L ²	2.1	square	vacuum, retract
GT31	IP40	0.1	0.1	0.2 + 50L ²	0.7	square	–
FMS100	IP50	2.0	0.5	0.2 + 3L ³	5.8	parallel	air pressure
FMS102	IP50	2.0	0.5	0.2 + 3L ³	5.8	square	air pressure
FMS130	IP50	2.0	0.5	0.2 + 3L ³	5.8	parallel	air pressure
FMS132	IP50	2.0	0.5	0.2 + 3L ³	5.8	square	air pressure

¹No bellows.

Analog probes

- Half-bridge probes.
- Measuring range: ± 0.25 to ± 10 mm.
- Repeatability: $< 0.15 \mu\text{m}$.
- Non-linearity: $< 0.3\%$.
- All non-pneumatic probes with cable guide have a cable exit square to probe body.



Feather Touch probes

Probes with a very small measuring force to measure sensitive materials like electronic components and thin-walled glass products.

Item No.	Type	Measuring range/mm	Max. travel mm	Measuring force/N	Total length mm	Price EUR
Feather Touch probes with a small measuring force and tungsten carbide probe tip:						
360.964	PRFC2P	± 1	3	0.18/1.10 ¹	75.6	460.00
360.965	PRFC5P	± 2.5	6	0.18/1.10 ¹	99.6	482.00
360.966	PRFC10P	± 5	11	0.18/1.10 ¹	130.1	356.00
360.960	PRFC2S	± 1	2.5	0.30	61.3	375.00
360.962	PRFC5S	± 2.5	6	0.30	96.3	420.00
360.963	PRFC10S	± 5	11	0.30	118.3	452.00
Option:						
360.967	Nylon probe tip					16.50
Probes with regular measuring force³:						
360.916	PR05	± 0.25	0.6	0.70	26	316.00
360.917	PR1	± 0.5	1.5	0.70	30.5	280.00
360.911	PR2	± 1	2.5	0.70	62	223.00
360.912	PR2P	± 1	3.5	0.80 ²	67	265.00
360.926	PR101P	± 1	11	0.70 ²	117.5	359.00
360.913	PR3	± 1.5	4	0.70	83.5	258.00
360.906	PR5	± 2.5	6	0.70	87.5	272.00
360.914	PR5P	± 2.5	6	0.85 ²	96.5	269.00
360.910	PR10	± 5	11	0.70	118	347.00
360.909	PR10P	± 5	11	0.70 ²	117	359.00
360.905	PR20	± 10	21	0.70	176	410.00
360.904	PR20P	± 10	21	0.70 ²	169	432.00

Measuring range, measuring force and extended probe length defined at electrical zero.

P = Pneumatic, probe is operated by air pressure.

¹ Air pressure 0.3 bar (nominal) / Air pressure 1.0 bar (nominal).

² Air pressure 0.4 bar (nominal).

³ Protection: IP65.

Digital absolute measuring probes

The measuring probe, which replaces the conventional analog probe more and more. These probes, that combine the advantages of the analog and not absolute digital models, are a solution to measuring systems which have to process the measuring data in a PC.

Configuration:

- Probe (clamping shaft 8h6) fixed via a cable (2 m) to the electronics module.
- T-CON connector.
- Cable (standard up to 5 m).
- Supply module (necessary with RS232C module, and with more than five probes on a board or module).
- RS232C/USB module or digital absolute measuring probe board (supports up to 100 probes).

Technical data:

- A maximum of 240 measurements per second.
- Repeatability: <math><0.15 \mu\text{m}</math>.
- Accuracy:
 DP-2S, DP-2P: $\pm 1 + 0.05 \%$,
 DP-5S, DP-5P: $\pm 1 + 0.05 \%$,
 DP-10S, DP-10P: $\pm 1 + 0.06 \%$,
 in which K is the displacement (in mm).
- Protection: IP65.
- Measuring force S-types: 0.7 N,
 P-types (at 0.4 bar pressure): 0.8 N.
- Also available on request as low measuring force *Feather Touch* models.

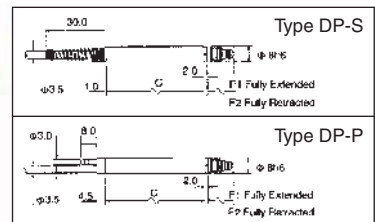
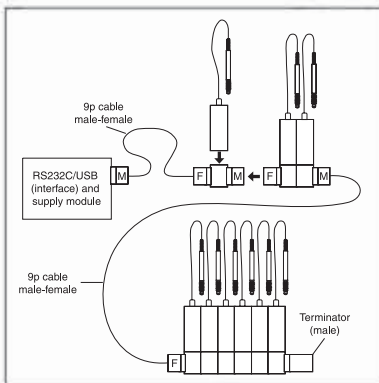

Item No.	Type	Measuring range/mm	Max. travel/mm	Probe movement	Dimensions/mm			Price EUR
					C	F1	F2	
360.880	DP-2S	± 1	3	spring push	46	13.9	10.9	560.00
360.881	DP-5S	± 2.5	6	spring push	65	17.4	11.4	629.00
360.882	DP-10S	± 5	11	spring push	89	25.4	14.4	677.00
360.883	DP-2P	± 1	3	pneumatic push	52	13.9	10.9	604.00
360.884	DP-5P	± 2.5	6	pneumatic push	71	17.4	11.4	652.00
360.885	DP-10P	± 5	11	pneumatic push	96	25.4	14.4	700.00
360.852	T-CON connector (has to be ordered separately per probe)							38.10
360.849	RS232C module to connect a maximum of 100 probes (delivered with OEM software for Win98/Win2000/WinXP)							539.00
360.835	Supply module (required when using a RS232C module and when connecting more than five probes to a board or module, excl. power cable)							420.00
420.300	Power cable							4.30
495.208	RS232C-USB adapter							27.90
360.890	Digiprobe PCI board Orbit 3							581.00
360.888	Digiprobe USB module Orbit 3							531.00
348.287	Cable 3 m between electronic module and board/module							18.30
348.288	Cable 5 m between electronic module and board/module							26.40

Clamping bush



Item No.	Description	Price EUR
780.398	Clamping bush VKE	9.30
780.397	Clamping screw VKD	4.30

Clamping bush

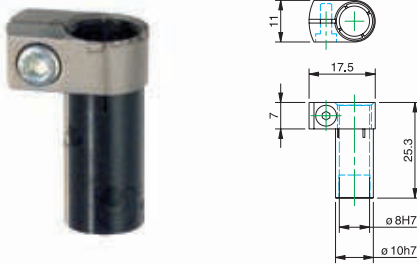

Item No.	Description	Price EUR
906.497	Clamping bush	39.20

Retraction device DZ801

Pneumatic retraction device for Magnescale and TESA gauges, with 1 meter hose and air tube connector.



Item No.	Description	Price EUR
344.465	Retraction device	147.00

Inserts

Many inserts with thread M2.5 are available. See the dial indicator accessories section for more information.

Clamp collar with dovetail

For clamping TESA GT31 probes and e.g. lever type dial indicators.

- Fastening points: $\varnothing 5.6$ mm, $\varnothing 9.5$ mm and with dovetail.

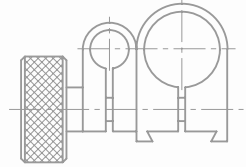

Item No.	Description	Price EUR
780.208	Clamp collar	25.00

Retraction levers

Universal retraction levers, bottom or top mounted, compatible with a wide range of probes and dial indicators. You can find various models in the dial indicator accessories section.



TESA vacuum pump

Electropneumatic vacuum pump for lifting up to 20 measuring probes simultaneously with a measuring force of up to 0.63 N.

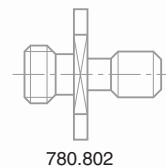

Item No.	Description	Price EUR
780.721	Vacuum pump	1,684.00
Option:		
780.802*	Air tube connector	21.00

* Also other models available.

MF measuring fixture system

MF is a universal construction system based on components to quickly and easily build custom measuring fixtures.

The system has been developed by Schut Geometrical Metrology. The parts of MF are made from high quality steel and colored, anodized aluminum.

The system consists of, among other things, base plates, parallel spring elements, mounting bars, probe holders and probes. A stable product positioning is required for accurate measurements and because of the system's sophisticated composition, it is possible to generate a complete measuring system with only a few parts. Ideal for repeating measurements.

The components of MF are based on both horizontal support or vertical clamping. The wide range and shapes of probes make the system suitable for e.g. lathed parts but also for (more complicated) milling parts. For these various applications some complete sets are available, as a starter-set or for specific applications. Besides this, the variety of individual components and the ease of use enable almost endless possibilities of applying and incorporating MF in other measuring fixtures that may be custom built or composed of other construction systems.

All individual components are available separately, increasing flexibility of use. Schut Geometrical Metrology has incorporated MF many times in custom built measuring systems (see elsewhere in this catalogue).

MF's high quality and low price make an ideal addition to existing measuring systems and can be applied in production plants.

The universal properties of MF result in a highly flexible construction system. The use of internationally applied units of fit for e.g. dial indicators and electronic probes make the system's components widely applicable. With just some base elements it is very easy to create some individual measuring points on e.g. production machines.

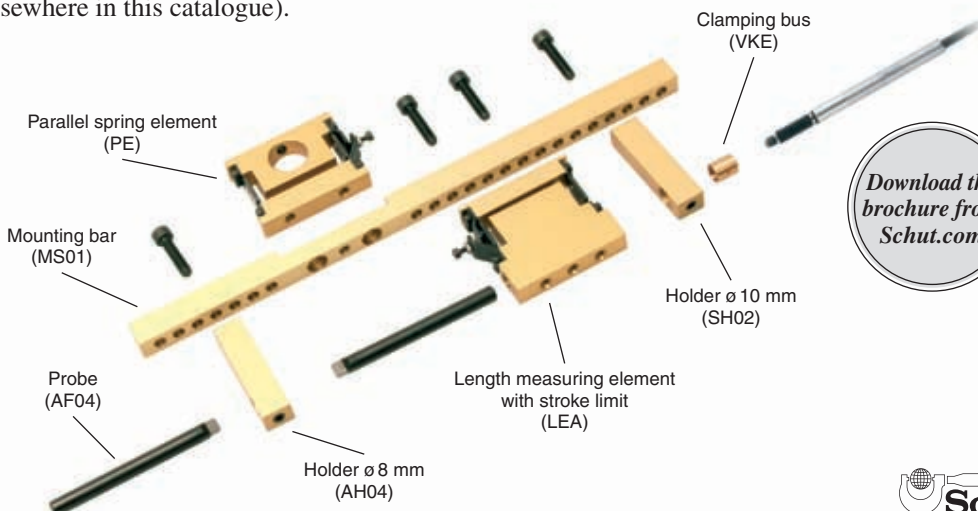
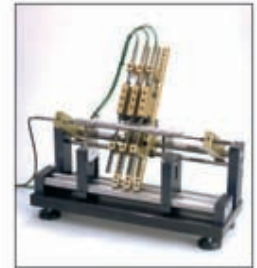

Download the
brochure from
Schut.com



MF measuring fixture system (continued)

For a quick start MF is also available in standard sets for a complete and quick solution for both horizontal support or vertical clamping.

One of the big advantages of MF is the ease and flexibility to create a stable measuring fixture especially suitable for repeating measurements with only very little effort and investments. To make the start with MF as easy as possible some standard sets have been composed that can realize the most occurring measuring fixtures.

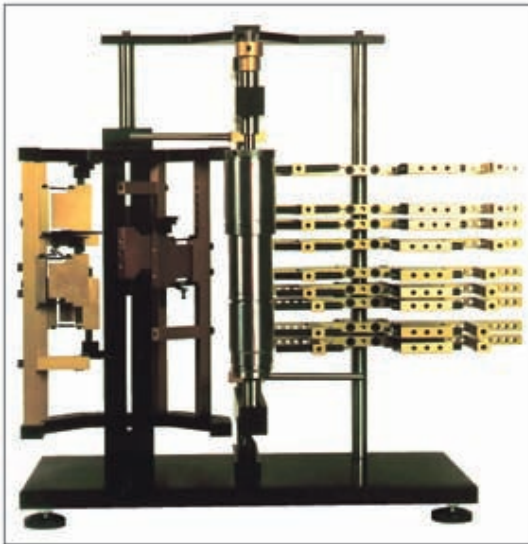

These sets consist of a composition of standard MF components, so it can be easily extended to your liking for specific applications. All in this catalogue depicted measuring fixtures are just a few of the many possibilities of MF.

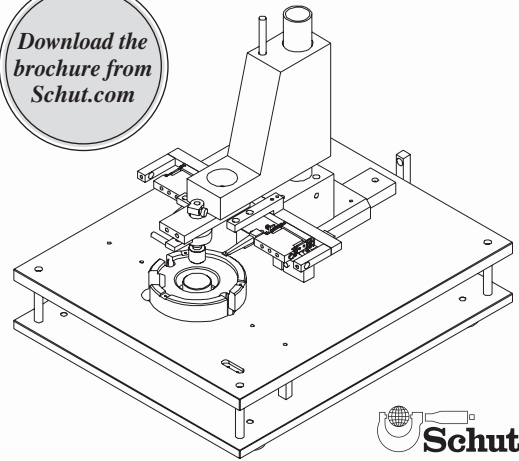

The easy assembly and modular setup make MF especially suitable for application in tailor-made and designed measuring systems.

For many years now Schut has been developing tailor-made solutions in measuring systems for its customers nationwide and abroad. On many occasions MF parts have been incorporated in these systems. We would be pleased to inform you about the possibilities to have your measuring system custom built, updated or extended.

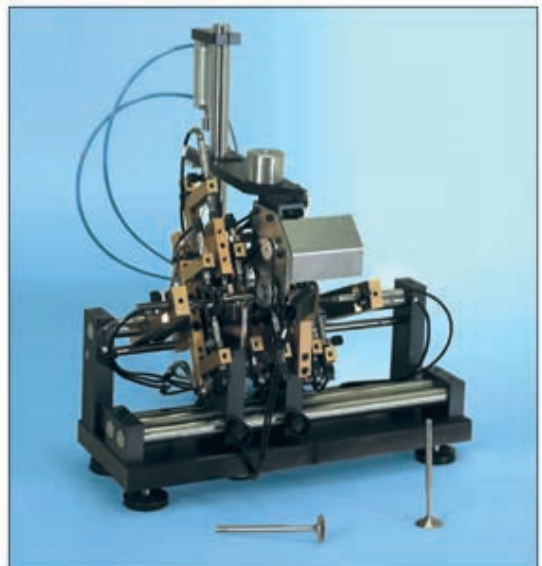

MF measuring fixture system – examples

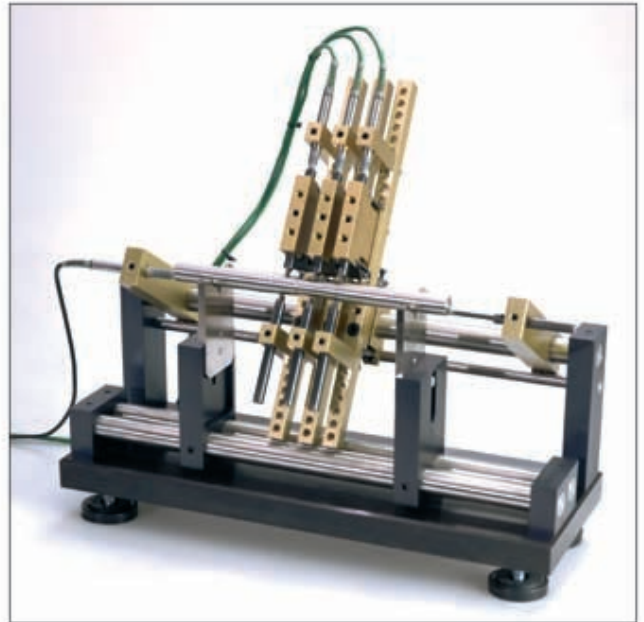
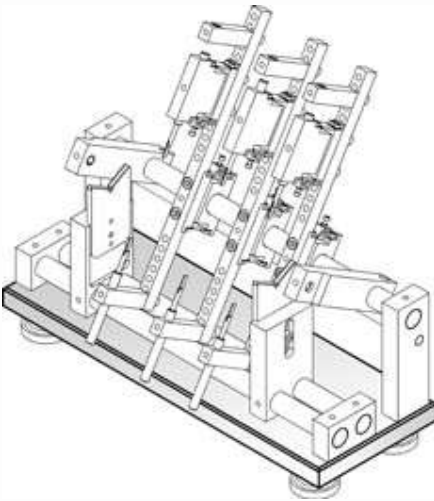
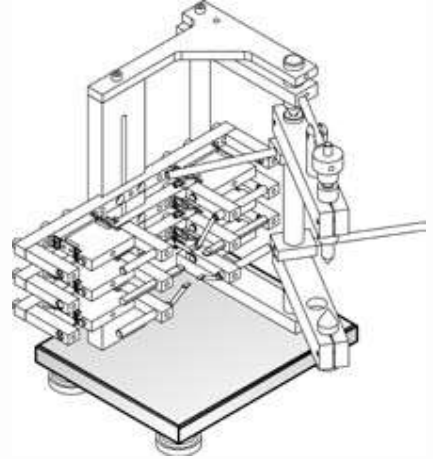

Download the
brochure from
Schut.com

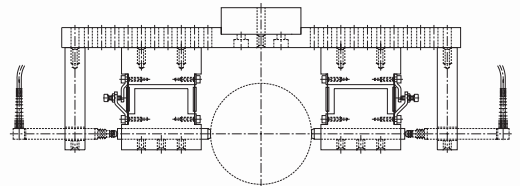
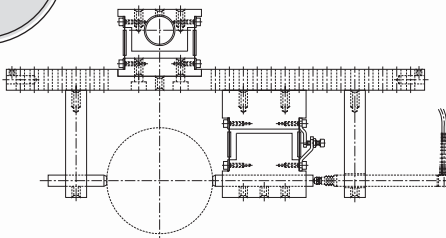

MF measuring fixture system – components

Besides the components shown below, there are various other types available.

Base plates

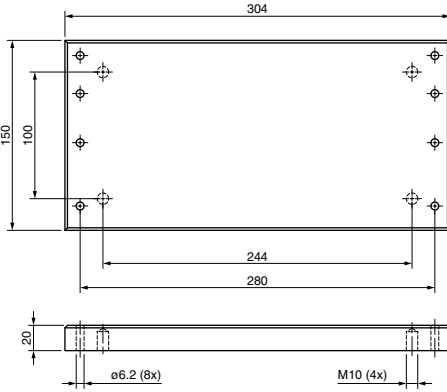

Shaft holders / shafts / support for V-block

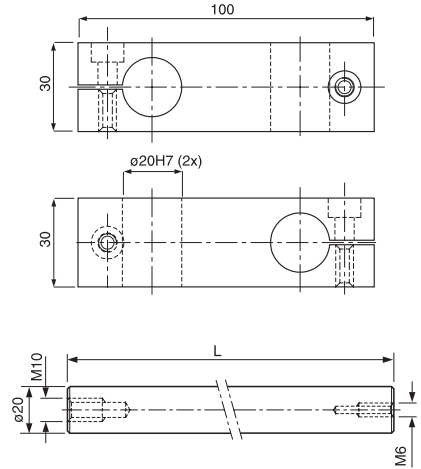

Connecting and mounting brackets

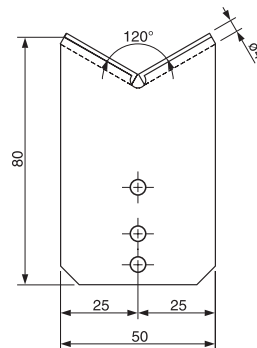
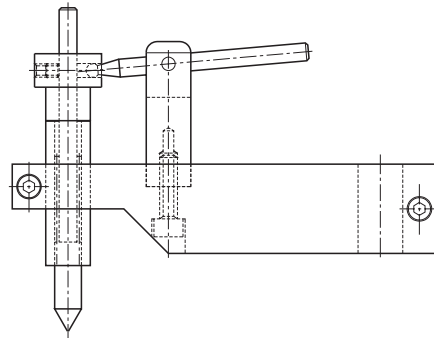
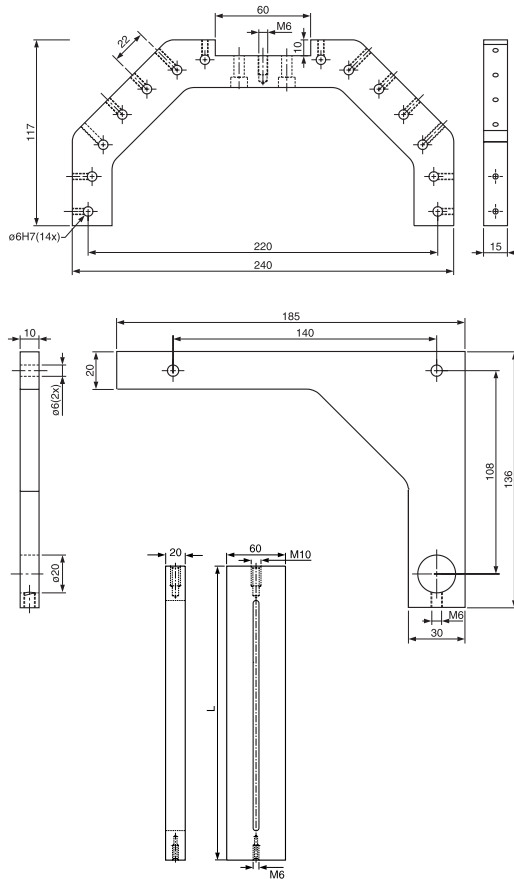

MF measuring fixture system – components (continued)

Besides the components shown below, there are various other types available.

Mounting bars / mounting blocks

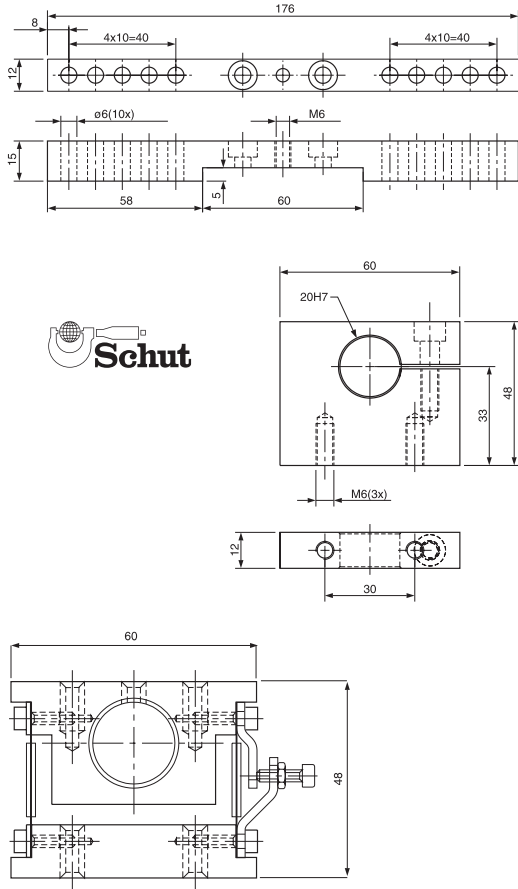

Measuring elements

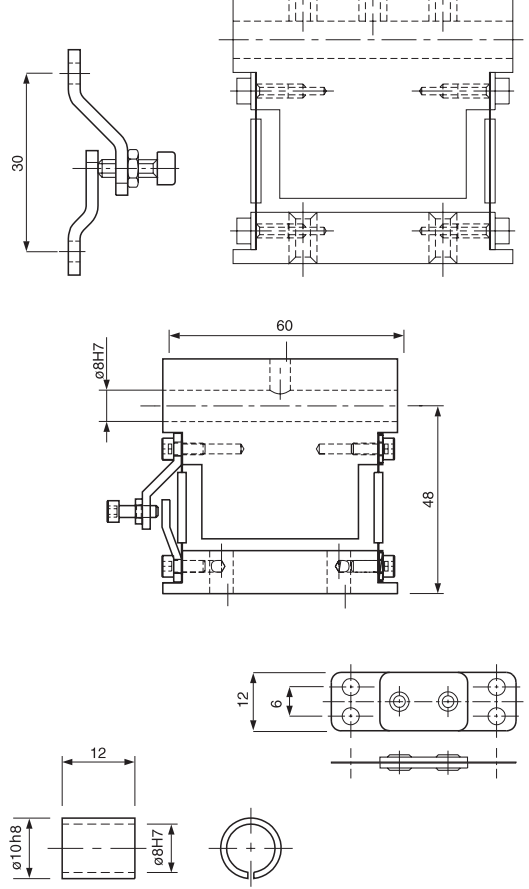

Probes / probe holders

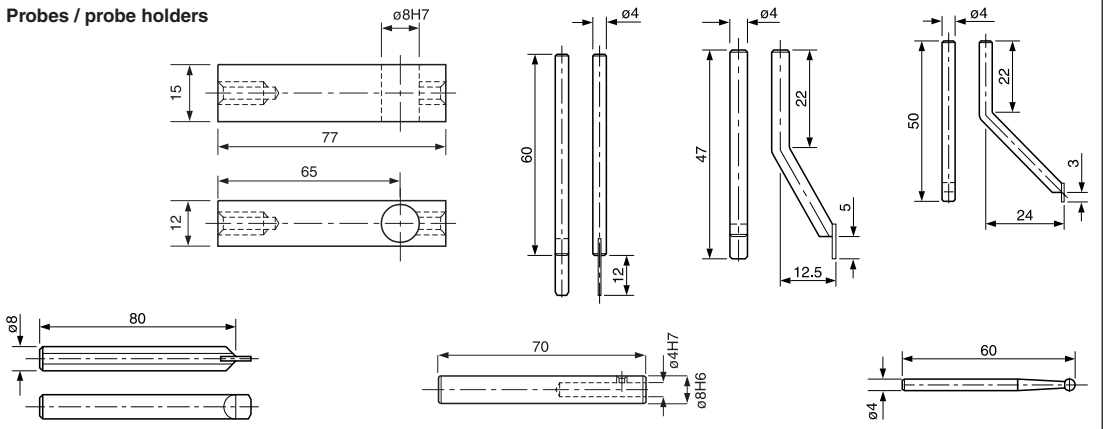

Stands / Bench centers / Surface plates



Flatness tolerances according DIN 876

Class	Flatness t_f (μm)
00	$2 + L/500$
0	$4 + L/250$
1	$10 + L/100$
2	$20 + L/50$
3	$40 + L/25$

L = length
in mm

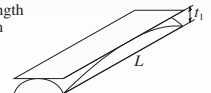

Dial indicator stands

- With dovetail joint (only 908.958/972).
- With fine adjustment (except 908.958/974).
- On/off switchable magnetic base with V-groove, except 908.973 (*flexform* base with locking mechanism and permanent magnetic force) and 908.974 (flat on/off switchable magnetic base).
- Various bases available.

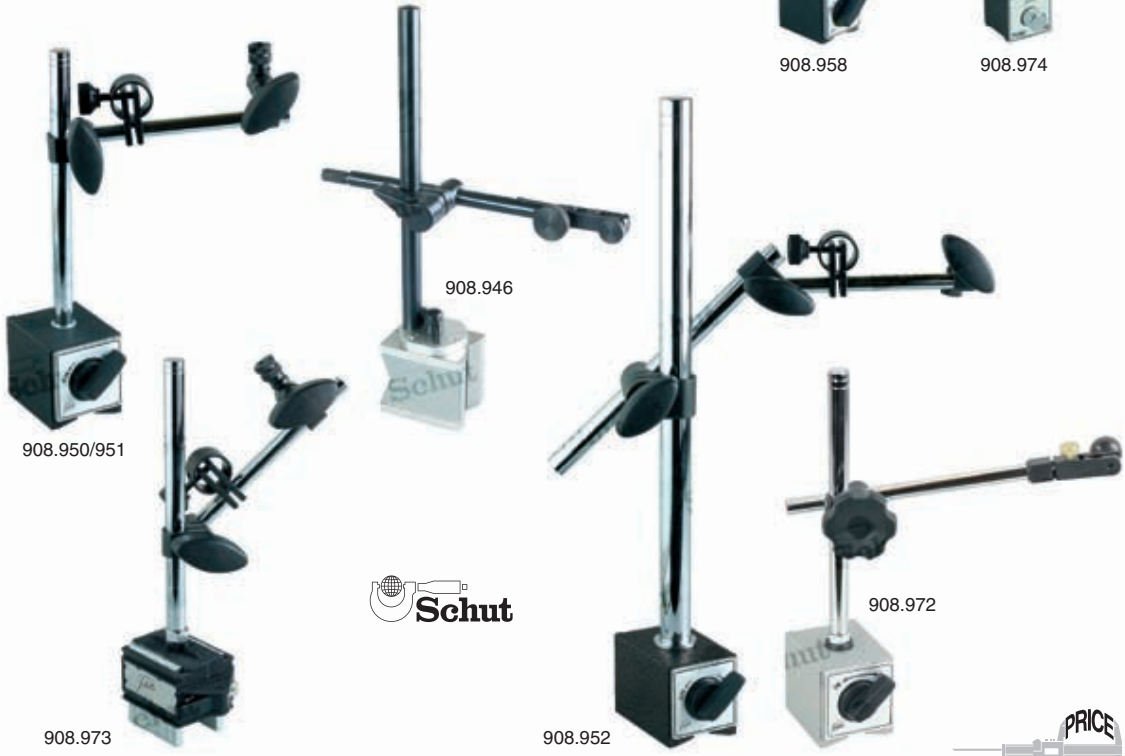

Item No.	Clamping shaft/mm	Column mm	Arm mm	Desc. of base	Dimensions l x w x h/mm	Magn. force ¹ /N	Thread of base	Price EUR
908.950	ø4/ø8	ø12x176	ø10x150	V-groove	58x50x55	600 ^(S)	M8x1.25	13.60
908.951	ø4/ø8	ø12x176	ø10x150	V-groove	58x50x55	800 ^(S)	M8x1.25	15.00
908.952	ø4/ø8	ø20x350	2 arms: ø14x200 ø10x150	V-groove	73x50x55	1000 ^(S)	M8x1.25	39.90
908.958	ø8	ø8x130	ø8x110	V-groove	36x30x35	400 ^(S)	M5x0.8	19.80
908.972	ø8	ø12x176	ø10x110	V-groove	58x50x55	800 ^(S)	M8x1.25	17.20
908.973	ø4/ø8	ø12x176	ø10x150	<i>flexform</i>	77x48x55	400 ^(P)	M8x1.25	19.20
908.974	ø6	ø7x55		flat	30x30x30	170 ^(S)	M5x0.8	19.90
908.946 ²	ø8	ø12x190	ø10x160	V-groove	54x40x47	800 ^(S)	M8x1.25	95.00

¹ S = switchable magnet; P = permanent magnetic force.

² V-groove on 3 sides.

Dial indicator stands

- Clamping shaft $\varnothing 8$ mm for dial indicators and probes, and dovetail joint for lever-type dial test indicators (908.957 without dovetail joint).
- With fine adjustment (except 908.962/964/957).
- Arm with mechanical central clamping device (908.954/955: hydraulic).
- On/off switchable magnetic base with V-groove, except 908.964 (permanent magnetic force), 908.961 (vacuum base) and 908.975 (*flexform* base with locking mechanism and permanent magnetic force).
- Various bases available.

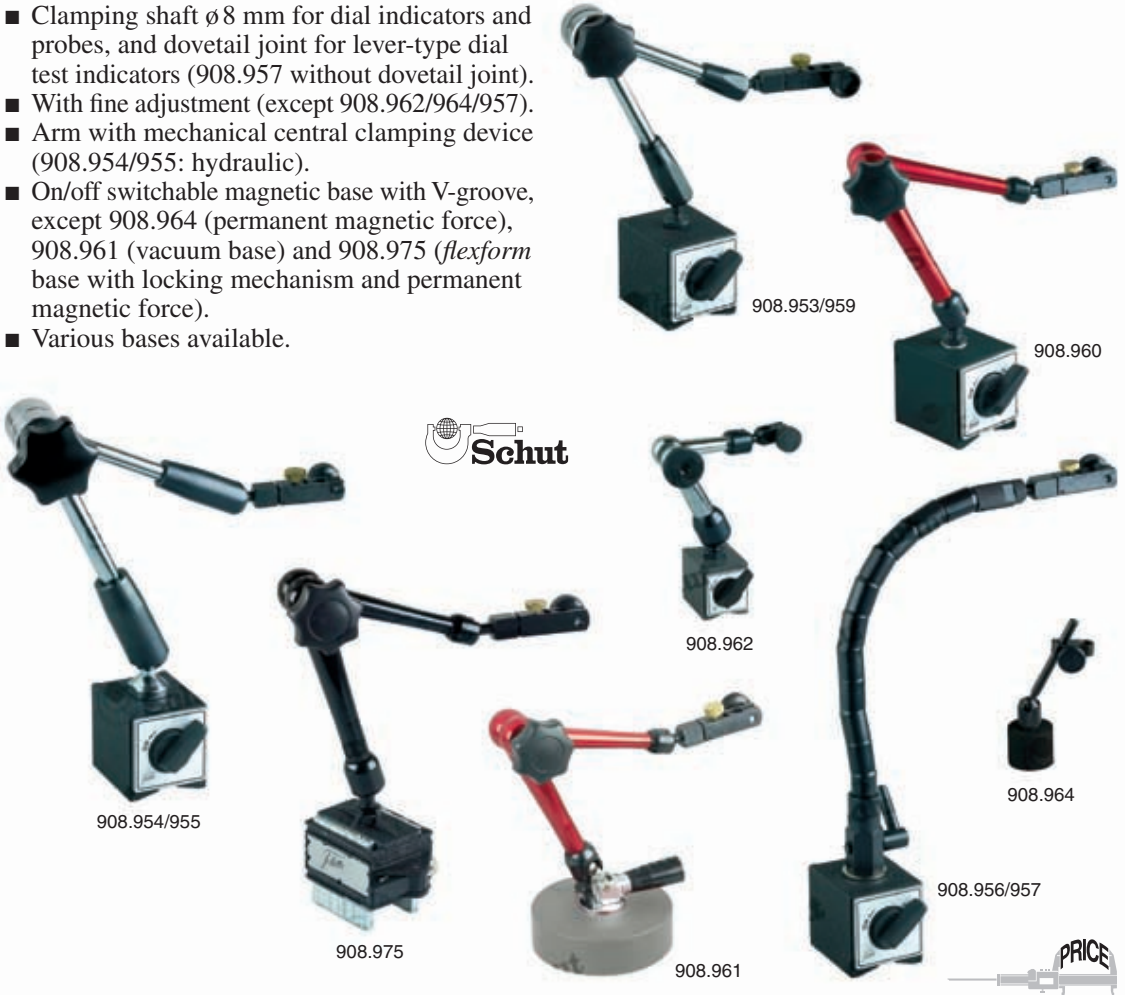

Item No.	Clamping	Arm length ¹ /mm	Description of base	Dimensions l x w x h/mm	Magnetic force ² /N	Thread of base	Price EUR
908.953	mechanical	300	V-groove	58 x 50 x 55	600 ^(S)	M8 x 1.25	26.00
908.959	mechanical	330	V-groove	58 x 50 x 55	800 ^(S)	M8 x 1.25	28.00
908.960	mechanical	285	V-groove	58 x 50 x 55	800 ^(S)	M8 x 1.25	31.50
908.954	hydraulic	385	V-groove	58 x 50 x 55	600 ^(S)	M8 x 1.25	51.00
908.955	hydraulic	370	V-groove	58 x 50 x 55	800 ^(S)	M8 x 1.25	53.00
908.962	mechanical	145	V-groove	36 x 30 x 35	400 ^(S)	M5 x 0.8	27.70
908.964	mechanical	65	cylinder	$\varnothing 30 \times 25$	170 ^(P)	M8 x 1.25	18.60
908.975	mechanical	270	<i>flexform</i>	77 x 48 x 55	400 ^(P)	M8 x 1.25	35.60
908.961	mechanical	280	vacuum base	$\varnothing 90 \times 28$		M8 x 1.25	35.60
908.956	mechanical	350	V-groove	58 x 50 x 55	800 ^(S)	M8 x 1.25	28.60
908.957	mechanical	330	V-groove	58 x 50 x 55	800 ^(S)	M8 x 1.25	28.00

¹ The outstretched length between base and clamping shaft.

² S=switchable magnet; P=permanent magnetic force.

Bases for dial indicator stands

A solid base is essential for accurate measurements. The dial indicator arms can be mounted on a strong magnetic or vacuum base.

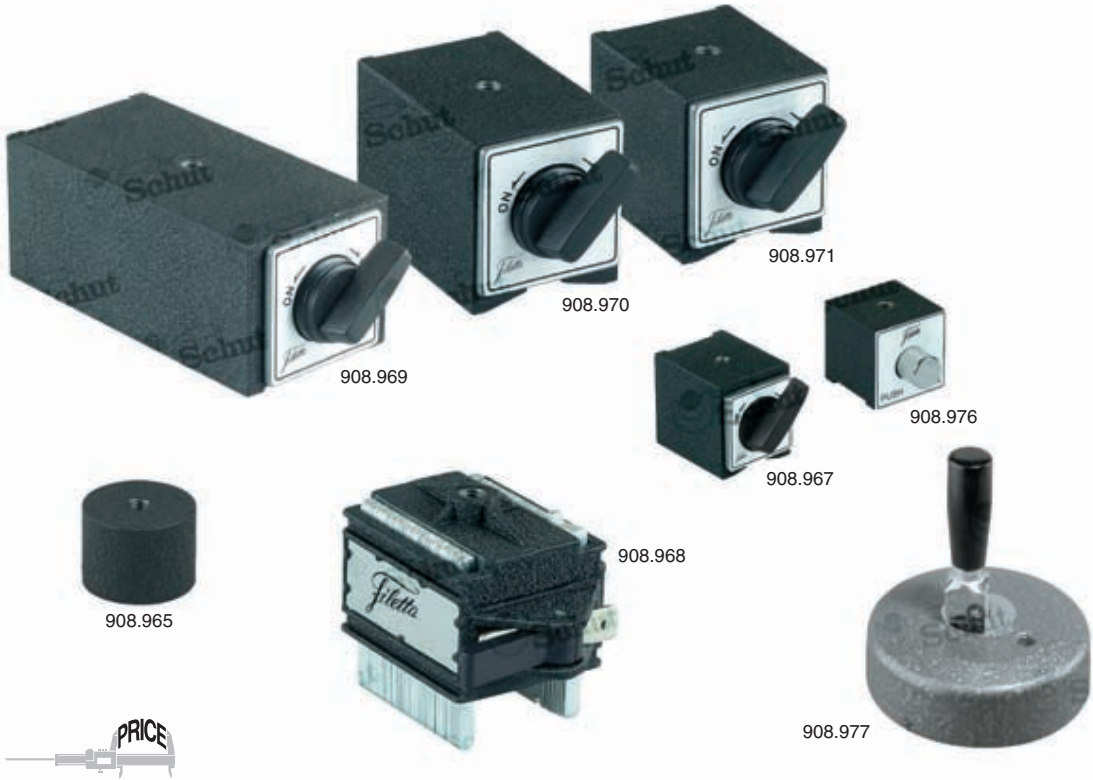

Item No.	Description	Dimensions l x w x h/mm	Magnetic force*/N	Thread	Price EUR
908.971	V-groove	58 x 50 x 55	800 (S)	M8 x 1.25	13.30
908.970	V-groove	73 x 50 x 55	1000 (S)	M8 x 1.25	18.50
908.969	flat base	117 x 50 x 52	1500 (S)	M8 x 1.25	55.00
908.967	V-groove	36 x 30 x 35	400 (S)	M5 x 0.8	14.50
908.976	flat base	30 x 30 x 30	170 (S)	M5 x 0.8	11.10
908.968	flexform	77 x 48 x 55	400 (P)	M8 x 1.25	25.50
908.965	cylinder	∅40 x 30	300 (P)	M8 x 1.25	13.90
908.977	vacuum base	∅90 x 28		M8 x 1.25	22.20

* S = switchable magnet; P = permanent magnetic force.

Fixing clamps for dial indicator stands

Item No.	Fixing clamp ∅/mm	Price EUR
907.440	12/10	6.90
907.442	10/8+6/6.5	6.90
907.443	10/8+4	6.90
907.444	14/8+6/6.5	10.00
907.441	20/14	23.10



Magnetic dial indicator stands

Solid dial indicator stands with on/off switchable magnetic base.

- Clamping shaft: $\varnothing 6$ and $\varnothing 8$ mm.
- Magnetic base with V-groove.
- Magnetic face at the back (except 855.707).



Item No.	Dimensions base <i>l x w x h</i> /mm	Magnetic force/N	Column mm	Arm mm	Thread of base	Price EUR
855.701	58 x 50 x 55	800	$\varnothing 12 \times 176$	$\varnothing 10 \times 150$	M8	53.00
855.705	73 x 50 x 55	1000	$\varnothing 20 \times 178$	$\varnothing 14 \times 165$	M8	138.00
855.707	117 x 50 x 55	1300	$\varnothing 20 \times 365$	$\varnothing 14 \times 200$	M20	234.00

Magnetic dial indicator stands

Solid dial indicator stands with on/off switchable magnetic base.

- Clamping shaft: $\varnothing 6$ and $\varnothing 8$ mm.
- Screw thread base: M8.
- Magnetic base with V-groove.
- Magnetic face at the back.



Item No.	Clamping	Dimensions base <i>l x w x h</i> /mm	Magnetic force/N	Arm length* mm	Price EUR
855.706	hydraulic	73 x 50 x 55	1000	335	304.00
855.710	mechanical	58 x 50 x 55	800	335	124.00

* The outstretched length between base and clamping shaft.

Fisso Classic Line dial indicator stands

These dial indicator stands are manufactured according to the classic principle with chrome plated arm parts, joint together with the three hinge points by means of a central mechanic clamping device. Because this is done with one on/off switch control, the stand can be positioned easily and precisely.

- Fine adjustment: with clamping shaft $\varnothing 8$ mm (for dial indicators and probes) and dovetail joint (for lever-type dial test indicators).
- Dial indicator not included.
- Various bases, fine adjustments and other accessories available; see “Fisso dial indicator stand accessories”.

NEW



839.870



837.290



837.287

Complete stands (incl. base and fine adjustment)

Item No.	Arm length/mm	Base type*	Magnetic force/N	Price EUR
839.870	130	S2	300	161.00
837.262	200	M	800	186.00
837.263	200	AM	600	215.00
837.290	200	AMO	600	236.00
837.264	200	TM	300	170.00
837.237	200	V	–	240.00
837.245	288	M	800	215.00
837.265	288	SM	1000	235.00
837.238	288	V	–	269.00
837.287	450	SM	1000	383.00
837.266	450	MM	1500	461.00
837.246	630	MM	1500	600.00

*For an extensive description of the base types see “Fisso dial indicator stand accessories”.



837.238



837.245



Item No.	Arm length/mm	Thread of head	Thread of base	Price EUR	Item No.	Price EUR
Separate arm without fine adjustment:					With fine adjustment:	
839.871	130	M6	M6	89.00	839.872	116.00
837.283	197	M6	M8	102.00	837.267	128.00
837.284	288	M6	M8	132.00	837.252	157.00
837.285	453	M8	M8	286.00	837.268	304.00
837.286	635	M8	M10 x 1.25	438.00	837.253	450.00

Fisso Strato Line and Strato μ -Line dial indicator stands

These dial indicator stands have a modern design with light metal arm parts in one piece, which, together with the three hinge points, are fixated by means of a mechanical clamping device. Because this is done with one on/off switch, the bases can be positioned easily and precisely.

Also available are the small dial indicator stands with an arm length of 130 mm – especially useful for places with confined space.

- Fine adjustment: with clamping shaft $\varnothing 8$ mm (for dial indicators and probes) and dovetail joint (for lever-type dial test indicators).
- Dial indicator not included.
- Various bases, fine adjustments and other accessories available; see “Fisso dial indicator stand accessories”.
- The Strato μ -Line models are equipped with a precision fine adjustment.



NEW



Complete stands (incl. base and fine adjustment)

Item No.	Arm length/mm	Base type ¹	Magnetic force/N	Price EUR
837.297	130	S2	300	170.00
837.270	130	TMS	150	156.00
837.288	130	C ²	–	116.00
839.455 ³	130	S3	600	315.00
837.242	200	M	800	200.00
837.243	200	TM	300	183.00
837.244	200	AM	600	229.00
837.289	200	AMO	600	249.00
837.239	200	V	–	233.00
839.456 ³	200	M	800	337.00
837.240	280	M	800	259.00
837.271	280	SM	1000	279.00
837.241	280	V	–	313.00
837.261	280	G	–	529.00
839.457 ³	287	M	800	399.00
839.873 ³	287	V	–	453.00
839.874 ³	287	SM	1000	419.00
837.230 ³	330	SM	1000	452.00
837.231 ³	330	G	–	703.00



837.288



¹ For an extensive description of the base types see “Fisso dial indicator stand accessories”.

² Long stem, $\varnothing 10 \times 40$ mm, thread M6 (not separately available).

³ With μ -Line precision fine adjustment (837.204).

Fisso Strato Line and Strato μ-Line dial indicator stands (continued)



Item No.	Arm length/mm	Thread of head	Thread of base	Price EUR	Item No.	Price EUR
Separate arm without fine adjustment (Strato Line):					With fine adjustment (Strato Line):	
837.281	130	M6	M6	98.00	837.272	124.00
837.282	200	M6	M8	116.00	837.251	141.00
837.247	280	M6	M8	178.00	837.250	200.00
Separate arm without fine adjustment (Strato μ-Line):					With fine adjustment (μ-Line):	
839.875	130	M6	M6	99.00	839.878 ³	261.00
839.876	200	M6	M8	117.00	839.879 ³	295.00
839.877	287	M8	M8	179.00	839.880 ³	341.00
837.912	330	M8	M8	221.00	837.232 ³	374.00

Fisso dial indicator stand accessories

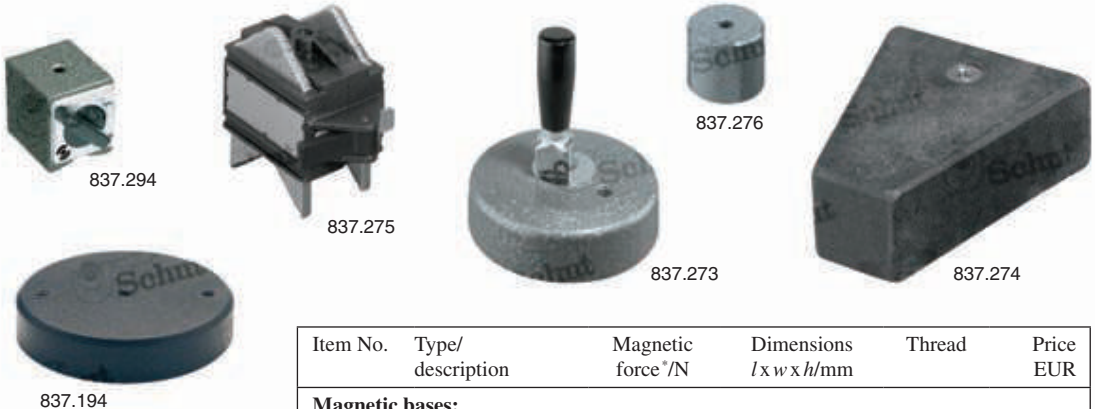

Item No.	Type/description	Magnetic force ¹ /N	Dimensions l x w x h/mm	Thread	Price EUR
Magnetic bases:					
837.294	S2 V-groove	300 ^(S)	34 x 30 x 35	M6	48.00
837.750	S3 V-groove	600 ^(S)	40 x 40 x 40	M6	56.00
837.254	M V-groove	800 ^(S)	60 x 50 x 55	M8	61.00
837.255	SM V-groove	1000 ^(S)	75 x 50 x 55	M8	82.00
837.256	MM flat	1500 ^(S)	120 x 60 x 55	M10 x 1.25	156.00
837.275	AM <i>anyform</i>	600 ^(P)	77 x 48 x 55	M8	91.00
837.291	AMO <i>anyform</i>	600 ^(S)	91 x 52 x 55	M8	113.00
837.276	TMS cylinder	150 ^(P)	∅ 30 x 25	M6	33.00
837.257	TM cylinder	300 ^(P)	∅ 40 x 30	M8	36.40
Other bases:					
837.273	V vacuum base		∅ 88 x 27	M8	117.00
837.274	G granite base		150 x 120 x 50	M8	343.00
837.194	- steel base		∅ 100 x 20	3x M6	45.00
837.195	- steel base		∅ 100 x 20	M8	45.00
837.196	- steel base		∅ 150 x 20	M6	48.00
837.292	- steel base		∅ 150 x 20	M8	48.00
837.193	- clamping base		80 x 20 x 40	2x M6	26.00
837.227	- clamping base		80 x 30 x 40	2x M8	33.80
Adapters for thread arm → base:					
837.280	Adapter M6 → M8 (hexagonal 13 x 25 mm, CrNi steel)				10.40
837.211	Adapter M8 → M6 (hexagonal 13 x 25 mm, CrNi steel)				10.40
837.804	Adapter M8 → M10 (∅ 20 x 37 mm, steel)				13.00
837.803	Adapter M8 → M12 (∅ 20 x 40 mm, steel)				13.00

¹S=switchable magnet; P=permanent magnetic force.



Fisso dial indicator stand accessories (continued)

Item No.	Thread	Price EUR
Fine adjustments*:		
837.279	M6	31.20
837.260	M8	31.20
Precision fine adjustment (µ-Line)*:		
837.204	M8	169.00
Dial indicator holders*:		
837.192	M6	17.40
837.191	M8	17.40
Reducer:		
837.190	ø8 → 6 mm	0.70

*With clamping shaft ø8 mm and dovetail joint.



Item No.	Span	Thread	Clamping jaws	Price EUR
Quick clamps:				
837.220	25 mm	M6	steel	48.00
837.228	50 mm	M8	steel	52.00
837.221	75 mm	M8	steel	71.00
Spring quick clamps:				
837.219	15 mm	M6	rubber, 50 mm	46.00
837.218	15 mm	M6	plastic, 21 mm	21.70

For more clamping and positioning possibilities (e.g. for medical applications) please contact our sales department.

Fisso Base Line dial indicator stands

Easy and handy dial indicator stands with high stability and accuracy.

- Fine adjustment: with clamping shaft ø8 mm (for dial indicators and probes) and dovetail joint (for lever-type dial test indicators).
- Mechanical clamping device.
- Dial indicator not included.



Complete stands (incl. base and fine adjustment)

Item No.	Column mm	Arm mm	Base type*	Magnetic force/N	Price EUR
837.224	ø 10 x 106	ø 8 x 75	S2	300	112.00
837.225	ø 12 x 156	ø 10 x 106	M	750	121.00
837.226	ø 14 x 184	ø 12 x 164	M	750	126.00

*For an extensive description of the base types see "Fisso dial indicator stand accessories".

Flexible hoses for coolant with magnetic base

- Suitable for cooling on machines in places of the workpiece that are difficult to reach.
- With 1, 2 or 3 flexible hoses.
- Special coupling for supply hose $\varnothing 8.5$ mm.

Support with magnetic base

- On/off switchable magnetic base with V-groove.
- Magnetic force: 588 N.
- Separate on/off switch for every flexible hose.
- Dimensions base $l \times w \times h$:
 906.213: 62 x 51 x 73 mm,
 906.214: 62 x 51 x 74 mm,
 906.215: 69 x 51 x 75 mm.

With round magnetic base

- Magnetic base $\varnothing 35$ mm, with high adhesive force.
- Metal protection plate under magnetic base.



906.213



906.214



906.215



906.216



906.217



906.218

Item No.	Number of flexible hoses	Price EUR
Support with magnetic base:		
906.213	1	29.60
906.214	2	36.30
906.215	3	45.00

Item No.	Number of flexible hoses	Price EUR
With round magnetic base:		
906.216	1	14.10
906.217	2	19.20
906.218	3	24.10

LED lamp on magnetic stand

- Total length: 215 mm.
- Magnetic force: 120 N.
- Power supply: 3 batteries type AAA.

Item No.	Description	Price EUR
909.607	LED lamp on magnetic stand	22.50
Option:		
497.914	Spare battery (3 needed)	0.40

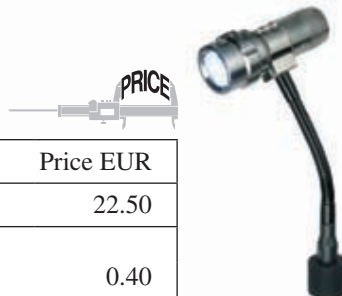

Measuring stands

- Clamping shaft: $\varnothing 8$ mm.
- Transverse arm with fine adjustment.
- Arm length: 150 mm.
- Ground base.
- Base with V-groove (only 857.120).



857.120



857.121

Item No.	Column \varnothing /mm	Dimensions base/mm	Effective arm length/mm	Price EUR
857.120	16	65 x 40 x 140	250	155.00
857.121	22	60 x 55 x 250	300	242.00

Measuring stand

- Clamping shaft: $\varnothing 8$ mm.
- Effective arm length: 180 mm.
- Fine adjustment.
- Ground base with V- and T-groove, 250 x 60 x 35 mm.
- Column: $\varnothing 16$ x 295 mm.
- Arm: $\varnothing 16$ x 235 mm.
- Mechanical clamping device.
- Dial indicator not included.

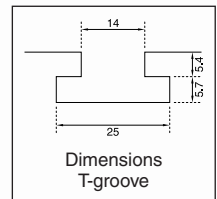

Item No.	Description	Price EUR
856.720	Measuring stand	149.00

Measuring stands

- Clamping shaft: $\varnothing 8$ mm.
- Transverse arm with fine adjustment.
- Ground base with T-groove.
- Base with V-groove (only 909.376).



906.219



Item No.	Column mm	Arm mm	Dimensions base/mm	Price EUR
906.219	$\varnothing 14 \times 185$	$\varnothing 12 \times 245$	220 x 60 x 35	43.00
909.376	$\varnothing 16 \times 290$	$\varnothing 16 \times 310$	260 x 60 x 50	113.00

Measuring stand with spindle adjustment

Measuring stand with clear graduation 0.02 mm on the spindle and a hand wheel for easy adjustment of the height setting.

- Clamping shaft: $\varnothing 8$ mm.
- Spindle thread pitch: 2 mm.
- Column: $\varnothing 35$ mm.
- Transverse arm: $\varnothing 20$ mm.
- Granite measuring table: 260 x 150 x 50 mm, measuring face: 250 x 150 mm, flatness according DIN 876/00.
- Total height: 410 mm.
- Max. measuring height: 160 mm.



Item No.	Description	Price EUR
907.789	Measuring stand	527.00



Measuring stand

Universal measuring stand, also suitable as a controlling measuring instrument.

- Clamping shaft \varnothing 8 mm and dovetail joint.
- Fine adjustment.
- Granite measuring table: 150 x 100 x 40 mm, flatness: $\leq 10 \mu\text{m}$.
- Base with groove in the center.
- Screw thread base: M8.
- Long, right side face with two mounting bores (thread M5, distance 120 mm).
- Mechanical clamping device.
- Arm length: 335 mm (the outstretched length between base and clamping shaft).
- Delivery in a aluminum case.



Item No.	Description	Price EUR
402.195	Measuring stand	195.00

Measuring stand

- Clamping shaft: \varnothing 8 mm.
- Total height: 200 mm.
- Max. measuring height: 90 mm.
- Effective arm length: 80 mm.
- Measuring table: 60 x 68 mm, ground and lapped.
- Dimensions transverse arm: \varnothing 18 x 120 mm.
- Column: \varnothing 22 mm.
- Other dial gauge holders are available on request.



Item No.	Description	Price EUR
857.130	Measuring stand	217.00

Measuring stands

Universal measuring stands with a cast iron, ground measuring table.

- Clamping shaft: $\varnothing 8$ mm (optional available clamp with clamping shaft $\varnothing 28$ mm).
- Fine adjustment: 5 mm (906.506/508/516/518).
- Total height: 250 mm (906.508: 350 mm).
- Max. measuring height: 160 mm (906.508: 260 mm).
- Effective arm length: 68 mm (906.507: max. 105 mm, 906.517/519: max. 95 mm).
- Measuring table: ground, 906.506/507/508: flat anvil/base, 906.516/517: round flat anvil (height anvil: 13.5 mm), 906.518/519: round serrated anvil (height anvil: 13.5 mm).
- Flatness table: $\leq 10 \mu\text{m}$.
- Dimensions transverse arm: $\varnothing 19.35 \times 150$ mm (906.507/517/519).
- Column: $\varnothing 30 \times 200$ mm (906.508: helical threaded with anti drop facility).



Item No.	Measuring height/mm	Dimensions table l x w x h/mm	Price EUR
906.506	140	140 x 105 x 50	127.00
906.507	160	140 x 105 x 50	105.00
906.508	260	140 x 105 x 50	139.00
906.516	130	$\varnothing 60 \times 65$	127.00
906.517	145	$\varnothing 60 \times 65$	105.00
906.518	130	$\varnothing 60 \times 65$	139.00
906.519	145	$\varnothing 60 \times 65$	105.00
Option:			
999.679	Clamp $\varnothing 28$ mm		143.00

NEW

Measuring stands

Universal measuring stands with a granite measuring table.

- Clamping shaft: $\varnothing 8$ mm (optional available clamp with clamping shaft $\varnothing 28$ mm).
- Fine adjustment: 5 mm (999.680).
- Total height: 240 mm (999.680/681),
355 mm (999.682/683),
370 mm (999.684/685).
- Max. measuring height: 260 mm (999.682/683/684/685).
- Effective arm length:
max. 165 mm (999.682/683/684/685),
(999.681: max. 105 mm, 999.680: 68 mm).
- Measuring table: granite.
- Flatness table: $\leq 5 \mu\text{m}$ (999.684/685: delivery with an inspection report), $\leq 10 \mu\text{m}$ (999.680/681/682/683).
- Dimensions transverse arm:
 $\varnothing 19.35 \times 150$ mm (999.681),
 $\varnothing 19.35 \times 210$ mm (999.682/683/684/685).
- Column:
 $\varnothing 30 \times 200$ mm (999.680/681),
 $\varnothing 30 \times 300$ mm (999.682/684),
 $\varnothing 30 \times 300$ mm (999.683/685: helical threaded with anti drop facility).



Item No.	Measuring height/mm	Dimensions table l x w x h/mm	Price EUR
999.680	140	150 x 100 x 40	195.00
999.681	160	150 x 100 x 40	171.00
999.682	260	250 x 200 x 55	230.00
999.683	260	250 x 200 x 55	245.00
999.684	260	400 x 400 x 70	273.00
999.685	260	400 x 400 x 70	289.00
Option:			
999.679	Clamp $\varnothing 28$ mm		143.00

NEW

Measuring stands

Measuring stands with a granite base in two models with a competitive price-performance ratio.

- Clamping shaft: \varnothing 8 mm.
- Max. measuring height: 250 mm.
- Anti drop facility.
- Granite table.
- Own product.



402.165

Item No.	Measuring height/mm	Flatness table/ μ m	Dimensions table l x w x h/mm	Column \varnothing /mm	Effective arm length/mm	Price EUR
402.165	150	10	150 x 100 x 40	25	62	169.00
402.168	250	10	250 x 200 x 55	35	100	275.00

Measuring stand

Heavy-duty precision stand with alumina ceramic grooved table and plain column.

- Clamping shaft: \varnothing 8 mm.
- Max. measuring height: 135 mm.
- Effective arm length: 62 mm.
- Measuring table: 80 x 80 x 22 mm.
- Flatness table: ± 2 μ m.
- Column: \varnothing 25 mm.
- Base: 150 x 89 x 37 mm.
- Anti drop facility.
- Own product.



Item No.	Description	Price EUR
334.690	Precision stand	355.00

Measuring table

Grooved measuring table made of alumina ceramics as applied to measuring stand 334.690, with the typical advantages of ceramics: high degree of hardness and wear resistance.

- Flatness: ± 2 μ m.
- Dimensions: 80 x 80 x 22 mm.
- Bottom-side: 3 tapped holes M6.

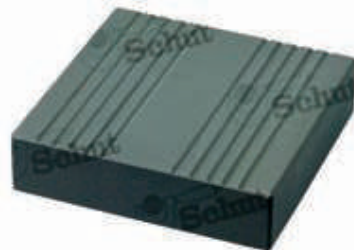

Item No.	Description	Price EUR
841.078	Measuring table	257.00

Measuring stands

- Clamping shaft: $\varnothing 8$ mm.
- Total height: 310 mm.
- Max. measuring height: 180 mm.
- Hard-chrome plated and ground column: $\varnothing 35$ mm.
- 857.126 and 857.128 with adjustable transverse arm ($\varnothing 22$ mm), length 220 mm.
- Granite measuring table: 260 x 150 x 48 mm (*l x w x h*), measuring face: 200 x 150 mm, flatness according DIN 876/00.



Item No.	Column	Effective arm length/mm	Price EUR
857.125	plain	104	466.00
857.126	plain	175	522.00
857.127	helical threaded	104	528.00
857.128	helical threaded	175	581.00

Measuring stands

- Clamping shaft: $\varnothing 20$ mm or $\varnothing 32$ mm.
- Max. measuring height: 290 mm.
- Effective arm length: 167 mm.
- Column: $\varnothing 50$ mm.
- 996.190/315 with anti drop facility.
- Granite measuring table: 400 x 400 x 70 mm, flatness: $\leq 5 \mu\text{m}$.
- Delivery with an inspection report.
- DIN 876/0.
- Own product.

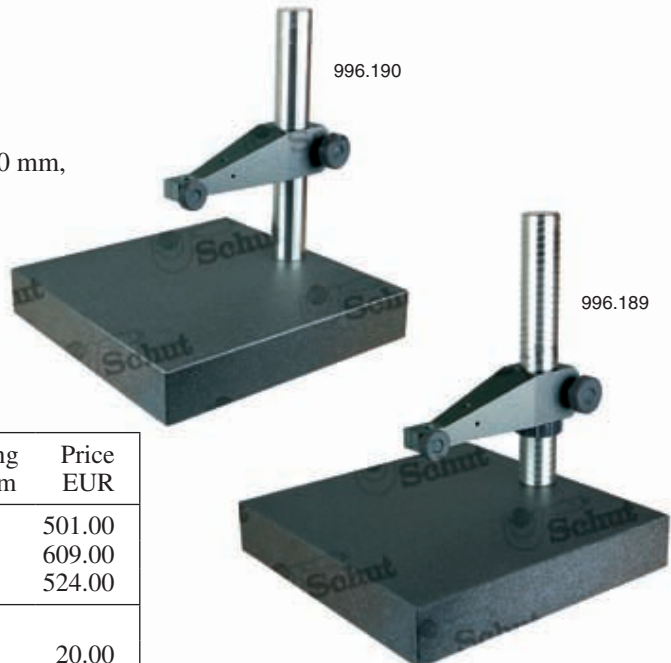

Item No.	Column	Clamping shaft/mm	Price EUR
996.190	plain	$\varnothing 20$	501.00
996.189	helical threaded	$\varnothing 20$	609.00
996.315	plain	$\varnothing 32$	524.00
Option:			
344.470	Reducing bush $\varnothing 20/8$ mm		20.00

Bench center

Cast iron base with the measuring face's accuracy according DIN 876/1. Supplied with two tailstocks, one with a fixed center point and one with an adjustable center point by means of a lever.

- Center height: 100 mm.
- Max. center distance: 450 mm.
- Center points: 60°.
- Stroke moveable center point: 8 mm.
- Delivery incl. measuring stand 857.141 (column $\varnothing 22 \times 230$ mm, clamping shaft 8H7, with fine adjustment), excl. dial indicator or measuring probe.
- Dimensions measuring face: 700 x 180 mm (incl. face for stand).
- Total height: 320 mm. (Height without stand: 200 mm.)
- Width T-slot: 12H7.
- Weight: 35 kg.

- Larger models with granite base are available on request.

Item No.	Type	Price EUR
857.131	RP 100-450	1,901.00



Item No.	Description	Price EUR
857.179	Pair of center points with tungsten carbide point 60°	161.00
857.178	Pair of center points with bore	97.00
857.175	Pair of prism inserts	171.00
857.136	Pair of V-blocks	253.00
857.137	Pair of roller blocks	284.00
857.176	Stop	99.00
857.177	Dial indicator holder	88.00
857.141	Extra measuring stand	137.00

Center points ($\varnothing 22$ mm)

- With tungsten carbide point 60°, or with bore according DIN 332-A 1.6 x 3.8.



Prism inserts 90°

- Capacity: $\varnothing 8$ -45 mm.
- Center height at $\varnothing 10$ mm: 130 mm.



V-blocks 90° and roller blocks

- Capacity V-blocks: $\varnothing 8$ -50 mm.
- Capacity roller blocks: $\varnothing 2$ -60 mm.
- Center height at $\varnothing 10$ mm: 100 mm.
- Stop (857.176): $\varnothing 8$ mm.
- Dial indicator holder (857.177): shaft 8H7.

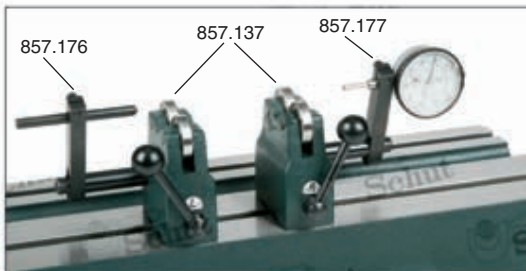

Bench centers

Cast iron base with the measuring face's accuracy according DIN 876/1. Supplied with two tailstocks, one with a fixed center point and one with an adjustable center point by means of a lever.

- Center height: 50 mm (without V-shaped supports) or 75 mm (P models; with V-shaped supports on the tailstocks).
- Max. center distance: 200 or 350 mm.
- Center points: 60°.
- Capacity V-shaped supports: \varnothing 5 - 20 mm.
- Stroke moveable center point: 8 mm.
- Delivery incl. measuring stand 857.140 (column \varnothing 16 x 220 mm, clamping shaft 8H7, with fine adjustment), excl. dial indicator or measuring probe.
- Dimensions measuring face: 350 x 110 or 500 x 110 mm (including face for measuring stand).
- Total height (incl. measuring stand): 260 mm.
- Width T-slot: 10H7.
- Vertical models are also available.

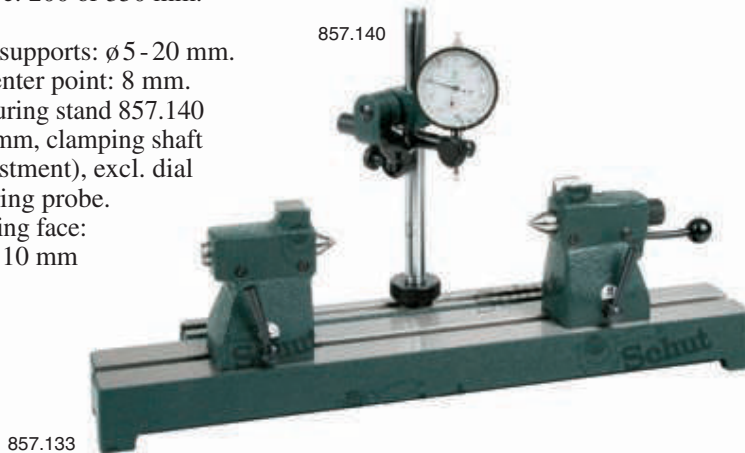

Item No.	Type	Center height mm	Max. center distance/mm	Measuring face/mm	Weight kg	Price EUR
857.132	RP 50-200	50	200	350x110	8	624.00
857.133	RP 75-200P	75	200	350x110	9	673.00
857.134	RP 50-350	50	350	500x110	11	775.00
857.135	RP 75-350P	75	350	500x110	12	819.00

Item No.	Description	Price EUR
857.174	Pair of center points with tungsten carbide point 60°	106.00
857.155	Pair of center points with bore	66.00
857.180	Pair of prism inserts	91.00
857.138	Pair of V-blocks	172.00
857.139	Pair of roller blocks	208.00
857.172	Stop	71.00
857.173	Dial indicator holder	70.00
857.140	Extra measuring stand	93.00



857.138



Center points (\varnothing 16 mm)

- With tungsten carbide point 60°, or with bore according DIN 332-A 1.6 x 3.8.



Prism inserts 90°

- Capacity: \varnothing 3 - 15 mm.
- Center height at \varnothing 10 mm: 70 mm (RP 50) or 95 mm (RP 75).



V-blocks 90° and roller blocks

- Capacity V-blocks: \varnothing 5 - 25 mm.
- Capacity roller blocks: \varnothing 2 - 40 mm.
- Center height at \varnothing 10 mm: 65 mm.
- Stop (857.172): \varnothing 8 mm.
- Dial indicator holder (857.173): shaft 8H7.

Bench center

Bench center with rotatable collet chuck. Cast iron base with the measuring face's accuracy according DIN 876/1.

- Center height: 75 mm.
- Measuring range: 0-100 mm (up to center).
- Capacity: $\varnothing 0.5-9.5$ mm.
- Concentricity of the tailstock quill: $\pm 5 \mu\text{m}$.
- Delivery incl. measuring stand 857.140 (column $\varnothing 16 \times 220$ mm, clamping shaft 8H7, with fine adjustment), excl. dial indicator or measuring probe and collet chuck.
- Dimensions measuring face: 200 x 110 mm (DIN 876/1) (incl. face for stand).
- Weight: 5.6 kg (857.184).
- Total height (incl. measuring stand): 270 mm.
- Width T-slot: 10H7.
- Concentricity accuracy collet chucks: 0.03 mm.



Item No.	Center height/mm	Price EUR
857.184	75	623.00
Option:		
857.182	Separate tailstock	525.00

Collet chucks

Item No.	Clamping range	Price EUR
857.272	0.5-1	51.00
857.273	1 -1.5	51.00
857.274	1.5-2	44.00
857.275	2 -2.5	44.00
857.276	2.5-3	44.00
857.277	3 -3.5	44.00
857.278	3.5-4	44.00
857.279	4 -4.5	44.00
857.280	4.5-5	44.00
857.281	5 -5.5	44.00
857.282	5.5-6	44.00
857.283	6 -6.5	44.00
857.284	6.5-7	44.00
857.285	7 -7.5	44.00
857.286	7.5-8	44.00
857.287	8 -8.5	44.00
857.288	8.5-9	44.00
857.289	9 -9.5	44.00

Bench center

Bench center with rotatable collet chuck.

- Measuring range: 0-50 mm (up to center).
- Capacity: $\varnothing 0.5-7$ mm.
- Clamping shaft: 8H7.
- Excl. dial indicator or measuring probe and collet chuck.
- Weight: 1.8 kg.
- Concentricity accuracy collet chucks: 0.03 mm.



Item No.	Description	Price EUR
857.185	Bench center	174.00

Collet chucks

Item No.	Clamping range	Price EUR
857.188	0.5-1	51.00
857.189	1 -1.5	51.00
857.190	1.5-2	44.00
857.191	2 -2.5	44.00
857.192	2.5-3	44.00
857.193	3 -3.5	44.00
857.194	3.5-4	44.00
857.195	4 -4.5	44.00
857.196	4.5-5	44.00
857.197	5 -5.5	44.00
857.198	5.5-6	44.00
857.199	6 -6.5	44.00
857.200	6.5-7	44.00

Fisso run out testers and balancing units

Run out tester with roller wheels or V-blocks for efficient testing of external, internal and surfaces of round products. Balancing unit with roller wheels for efficient testing of grinding wheels and other round products. The supports are adjustable and can be fixed on the base plate by means of a lever. Ideal for control in the production environment.

- Diameter compensation run out tester: max. 60 mm.
- Workpiece run out tester: max. \varnothing 240 mm, workpiece balancing unit: max. \varnothing 500 mm.
- Weight workpiece: max. 25 kg.
- Length base plate:
run out tester: 500 or 1000 mm,
balancing unit: 330 or 500 mm.
- Width T-slot: 14 mm.

Model with roller wheels

- Accuracy roller wheel: ± 0.005 mm.
- Roller wheel: \varnothing 120 mm.

Model with V-blocks

- Tungsten carbide supports.

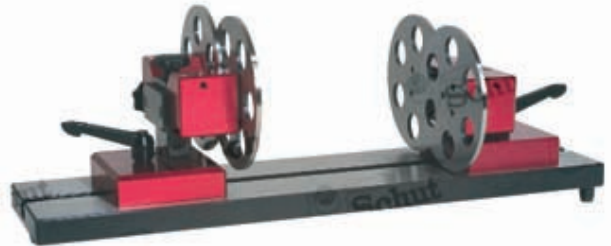

837.214

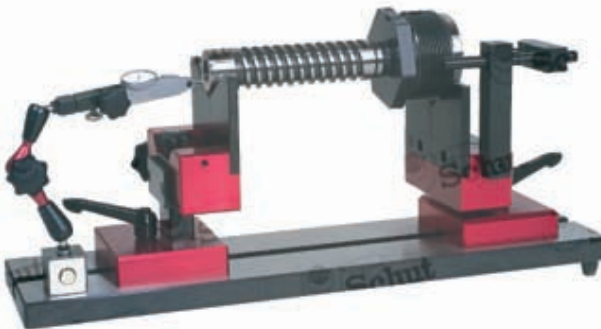

837.216



837.222

Item No.	Length base plate/mm	Weight kg	Price EUR
Run out tester with roller wheels:			
837.214	500	approx. 14	3,800.00
837.215	1000	approx. 23	4,410.00
Run out tester with V-blocks:			
837.216	500	approx. 14	3,800.00
837.217	1000	approx. 23	4,410.00
Balancing unit:			
837.222	330	approx. 13	2,850.00
837.223	500	approx. 16	3,390.00



Granite surface plates

Black granite surface plates according to DIN 876 specifications. Sizes vary from 250 x 250 mm to 2000 x 1500 mm.

- Delivery with an inspection report.
- Straight beveled edges.
- Cover (synthetic leather) optionally available.
- Surface plate stand optionally available (see “surface plate accessories” elsewhere in this catalog).



402.252

Delivery ex Groningen, Netherlands



Dimensions <i>l x w x h</i> mm	Weight ¹ kg	Accuracy according DIN 876/1		Accuracy according DIN 876/0		Accuracy according DIN 876/00		Cover ²	
		Item No.	Price EUR	Item No.	Price EUR	Item No.	Price EUR	Item No.	Price EUR
250 x 250 x 50	13	402.000	103.00	402.020	112.00	402.040	135.00	402.250	14.50
400 x 250 x 50	20	402.001	186.00	402.021	201.00	402.041	212.00	402.251	21.00
400 x 400 x 70	41	402.002	219.00	402.022	232.00	402.042	285.00	402.252	24.50
630 x 400 x 70	65	402.003	399.00	402.023	415.00	402.043	483.00	402.253	28.50
630 x 630 x 80	108	402.004	454.00	402.024	491.00	402.044	586.00	402.254	31.50
800 x 500 x 100	136	402.005	484.00	402.025	516.00	402.045	628.00	402.255	37.50
900 x 600 x 100	188	402.006	696.00	402.026	800.00	402.046	907.00	402.256	43.00
1000 x 630 x 100	223	402.007	866.00	402.027	950.00	402.047	1,072.00	402.257	56.00
1000 x 630 x 150	317	402.008	936.00	402.028	990.00	402.048	1,123.00	402.257	56.00
1000 x 1000 x 100	342	402.009	1,227.00	402.029	1,233.00	402.049	1,590.00	402.258	70.00
1000 x 1000 x 150	504	402.010	1,262.00	402.030	1,270.00	402.050	1,647.00	402.258	70.00
1200 x 800 x 120	394	402.011	1,198.00	402.031	1,206.00	402.051	1,607.00	402.259	58.00
1200 x 800 x 150	467	402.012	1,270.00	402.032	1,280.00	402.052	1,668.00	402.259	58.00
1500 x 1000 x 150	750	402.013	2,100.00	402.033	2,250.00	402.053	2,560.00	402.260	75.00
1500 x 1000 x 200	971	402.014	2,200.00	402.034	2,360.00	402.054	2,690.00	402.260	75.00
2000 x 1000 x 200	1295	402.015	3,400.00	402.035	3,640.00	402.055	4,010.00	402.261	95.00
2000 x 1000 x 250	1600	402.016	3,820.00	402.036	4,100.00	402.056	4,510.00	402.261	95.00
2000 x 1500 x 300	2815	402.017	8,480.00	402.037	9,200.00	402.057	9,970.00	402.262	125.00

¹Weight including wooden packing.

²Dimensions of the covers are equal to the length and the width of the surface plate, all covers have a depth of 50 mm.

Cast iron surface plates

Extra heavy, cast iron surface plates.

- Three models:
 - milled (smoothened), accuracy according DIN 876/3,
 - hand scraped, accuracy according DIN 876/1,
 - fine scraped, accuracy according DIN 876/0.
- The side faces of all plates are milled and varnished.
- Surface plate stand optionally available
(see “surface plate accessories” elsewhere in this catalog).



403.212

Delivery ex Groningen, Netherlands

Dimensions <i>l x w</i> mm	Weight kg (approx.)	Accuracy according DIN 876/3		Accuracy according DIN 876/1		Accuracy according DIN 876/0	
		Item No.	Price EUR	Item No.	Price EUR	Item No.	Price EUR
200 x 200	7	403.236	74.00	403.208	107.00	403.185	133.00
250 x 250	12	403.237	92.00	403.209	141.00	403.186	176.00
300 x 300	15	403.238	122.00	403.210	191.00	403.187	233.00
400 x 250	25	403.239	130.00	403.211	202.00	403.188	274.00
400 x 400	35	403.240	162.00	403.212	292.00	403.189	379.00
500 x 500	50	403.241	261.00	403.213	444.00	403.190	556.00
600 x 400	45	403.242	250.00	403.214	418.00	403.191	545.00
630 x 630	90	403.243	482.00	403.215	759.00	403.192	910.00
800 x 500	95	403.249	508.00	403.221	823.00	403.193	1,012.00
1000 x 600	140	403.245	789.00	403.217	1,200.00	403.194	1,582.00
1000 x 1000	270	403.246	1,090.00	403.218	1,708.00	403.195	2,210.00
1200 x 800	300	403.250	1,188.00	403.222	1,722.00	403.196	2,220.00
1500 x 1000	650	403.247	2,290.00	403.219	3,160.00	403.197	3,920.00
2000 x 1000	1000	403.248	3,000.00	403.220	4,300.00	403.198	5,440.00

Ceramic surface plates

Surface plates made of alumina ceramics are very durable, even under mechanically or chemically aggravating conditions. Some other important characteristics of alumina ceramics are:

- Low density.
- Low linear expansion coefficient.
- Low thermal conduction coefficient.
- High degree of hardness.
- Highly wear resistant.
- High rigidity through its unique hollow structure, as well as light in weight.
- Exceptionally strong.
- Easy to maintain.

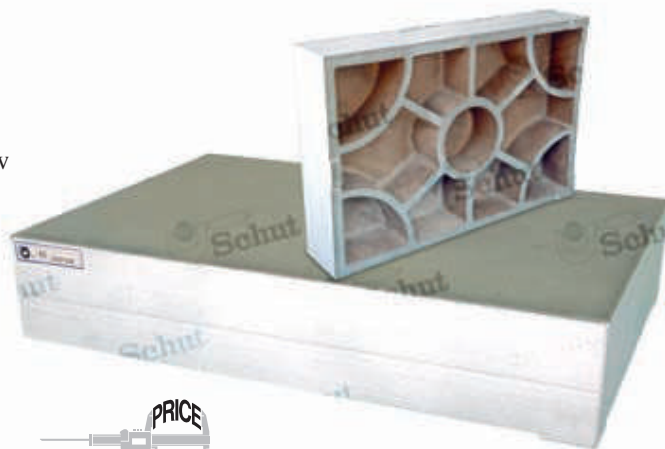

Delivery ex Groningen, Netherlands

Item No.	Flatness mm	Dimensions <i>l x w x t</i> /mm	Weight kg	Price EUR
Class A:				
908.713	0.008	600 x 450 x 90	45	1,940.00
Class AAA:				
908.706	0.002	450 x 300 x 90	20	1,134.00
908.707	0.002	600 x 450 x 90	45	2,350.00
908.708	0.003	630 x 630 x 150	90	3,270.00



Fine scraped plate (DIN 876/1) with lapp and inspection surface

Special duplex plate with one flat inspection surface and one squared lapp surface, both fine scraped according to DIN 876/1. The squared side is especially suitable for lapping products on a very flat surface. The combination of the two plates saves a lot of space. When using the optionally available wooden case the surface plate can be used on both sides without the risk of damaging the surfaces, because the top and bottom side of the case can be separated.

- Flatness: 14 µm.
- Dimensions *l x w x h*:
360 x 260 x 65 mm.
- Weight: approx. 24 kg.

Item No.	Description	Price EUR
403.150	Duplex plate	264.00
403.151	Wooden case for double-sided use of the duplex plate	64.00



Surface plate supports

- For use with large granite or cast iron surface plates with a minimum size of 1000 x 630 mm.
- Support adjustable in height, with adjusting bolt and lock nut.
- For granite and cast iron surface plates it is advisable to use 5 supports, 3 for the Bessel points and 2 for tilt protection.
- Delivery incl. adjusting bolt, excl. required supporting cup.



NEW



403.253 + 999.553

Item No.	Description	Height/mm		Price EUR
		min. ¹	max. ^{1,2}	
403.253	Surface plate support	540	580	185.00
403.254	Surface plate support	640	680	219.00
403.298 ³	Set of 5 supports	545	580	755.00
403.299 ³	Set of 5 supports	645	680	889.00
999.553 ⁴	Supporting cup			25.00
997.343 ⁵	Support set			60.00

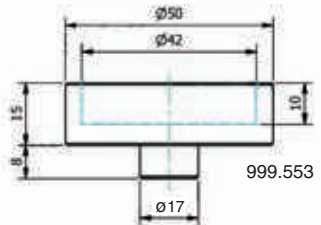

999.553

¹ Height without supporting cup and supporting set.

² Maximum height with adjusting bolt 27 mm (thread diameter) in support.

³ Set consists of 3 supports and 2 tilt protectors.

⁴ Required for granite and cast iron (in combination with support set) surface plates.

⁵ Required for granite surface plates (in combination with supporting cups).

Support set for surface plates

Support set for placing a small surface plate on a working table.

- Set consists of support based on 3 Bessel points and two tilt protectors.
- Diameter: 40 mm.

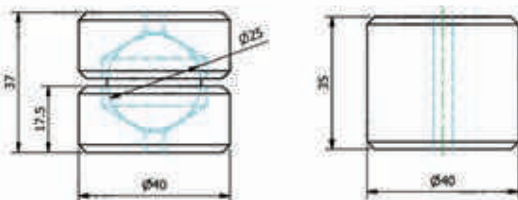

Item No.	Description	Price EUR
997.343	Support set	60.00

Surface plate cleaner

Surface plate cleaner for granite surface plates. Rubbing in the cleaner dissolves any flaws on the plate's surface. Dust, dirt, grease stains, finger and hand prints will disappear.



Item No.	Description	Price EUR
407.303	Cleaner, 500 ml	7.00

Surface plate stands

Extremely solid surface plate stand. Construction is determined on the basis of the Bessel points and has a slide protection. Working height is standard 900 mm.



Delivery ex Groningen,
Netherlands



Item No.	For granite surface plates dimensions $l \times w \times t$ /mm	Price EUR
131.020	630 x 630 x 80	452.00
131.019	800 x 500 x 100	448.00
131.013	900 x 600 x 100	445.00
131.018	1000 x 630 x 100	455.00
131.035	1000 x 630 x 150	453.00
131.017	1000 x 1000 x 100	469.00
131.036	1000 x 1000 x 150	467.00
131.016	1200 x 800 x 120	463.00
131.037	1200 x 800 x 150	461.00
131.015	1500 x 1000 x 150	472.00
131.038	1500 x 1000 x 200	470.00
131.014	2000 x 1000 x 200	511.00
131.039	2000 x 1000 x 250	509.00



Chest of
drawers optional

Item No.	For cast iron surface plates dimensions $l \times w$ /mm	Price EUR
131.030	1000 x 600	432.00
131.029	1000 x 1000	451.00
131.041	1200 x 800	451.00
131.022	1500 x 1000	502.00
131.031	2000 x 1000	521.00

Surface plate stands

Extremely solid surface plate stands with excellent price-performance ratio. Support of the surface plate is determined on the basis of the bessel points and has an optional slide protection and chest of drawers. Working height is depending on the surface plate thickness. The standard models and the models with the optional chest of drawers for surface plates equal to or larger than 1000 x 1000 mm bear the load at the bessel points.

- Custom made is optionally available.
- Difference min. and max. height incl. surface plate: 25 mm.
- Delivered incl. support (bessel) and sleeping points.



NEW

131.101 +
131.113 +
131.108 +
402.028



Delivery ex Groningen, Netherlands

Item No.	For granite surface plates dimensions <i>l x w x t/mm</i>	Height incl. surface plate		Price EUR
		min./mm	max./mm	
Surface plate stand (standard model)¹:				
131.100	630 x 630 x 80	880	905	382.00
131.100	800 x 500 x 100	900	925	382.00
131.100	900 x 600 x 100	900	925	382.00
131.100	1000 x 630 x 100	900	925	382.00
131.100	1000 x 630 x 150	950	975	382.00
131.104	2000 x 1000 x 200	850	875	399.00
131.104	2000 x 1000 x 250	900	925	399.00
Surface plate stand¹ (prepared for chest of drawers):				
131.101 ²	630 x 630 x 80	880	905	384.00
131.101 ²	800 x 500 x 100	900	925	384.00
131.101 ²	900 x 600 x 100	900	925	384.00
131.101 ²	1000 x 630 x 100	900	925	384.00
131.101 ²	1000 x 630 x 150	950	975	384.00
131.102	1000 x 1000 x 100	850	875	395.00
131.102	1000 x 1000 x 150	900	925	395.00
131.102	1200 x 800 x 120	870	895	395.00
131.102	1200 x 800 x 150	900	925	395.00
131.103	1500 x 1000 x 150	850	875	397.00
131.103	1500 x 1000 x 200	900	925	397.00

¹ RAL 7035.

² Do not bear the load at the bessel points.

³ Incl. fasteners.

⁴ Sleeping 2 and bessel points 3 needed.

Options

Item No.	For granite surface plates dimensions <i>l x w x t/mm</i>	Price EUR
Slide protection^{1,3} for surface plate stands:		
131.105	630 x 630 x 80	92.00
131.106	800 x 500 x 100	96.00
131.107	900 x 600 x 100	107.00
131.108	1000 x 630 x 100/150	116.00
131.109	1000 x 1000 x 100/150	101.00
131.110	1200 x 800 x 120/150	119.00
131.111	1500 x 1000 x 150/200	125.00
131.112	2000 x 1000 x 200/250	128.00
Bessel and sleeping points:		
131.115 ⁴	Sleeping point (tilt protection) (height: 30 mm higher than standard)	14.70
131.116 ⁴	Bessel point (height: 30 mm higher than standard)	14.70
Chest of drawers:		
131.113 ³	Chest of drawers (RAL 5015), incl. fasteners, 610 x 480 x 470 mm (<i>w x d x h</i>); 3 drawers. Inside dimensions drawers (<i>w x d x h</i>): upper drawer: 515 x 395 x 90 mm, middle drawer: 515 x 395 x 105 mm, lower drawer: 515 x 395 x 135 mm.	386.00

V-blocks / Vises / Angle plates / Cylindrical squares
Squares / Parallels / Straight edges



Flatness tolerances according DIN 874	
Class	Flatness t_1 (μm)
00	$1+L/150$
0	$2+L/100$
1	$4+L/60$
2	$8+L/40$

Squareness tolerances according DIN 875	
Class	Squareness (μm)
00	$2+L/100$
0	$5+L/50$
1	$10+L/20$
2	$20+L/10$

Flatness tolerances according DIN 876	
Class	Flatness t_1 (μm)
00	$2+L/500$
0	$4+L/250$
1	$10+L/100$
2	$20+L/50$
3	$40+L/25$

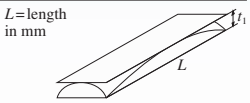

V-blocks in pairs

V-blocks for clamping, processing, aligning and inspecting cylindrical objects, available in three classes.

- **Class 3:** Parallelism: 60 µm.
Base and prism face smooth planed, short and long side processed.
- **Class 1:** Parallelism: 16 µm.
Base and prism face hand scraped, short and long side processed.
- **Class 0:** Parallelism: 8 µm.
Base and prism face and short side fine scraped, long side processed.
- Ground in matched pairs.
- V-groove: 90°.



Dimensions $l \times w \times h$ mm	Capa- city ϕ /mm	Weight p. pair kg	Class 3		Class 1		Class 0	
			Item No.	Price EUR p. pair	Item No.	Price EUR p. pair	Item No.	Price EUR p. pair
Steel:								
100 x 40 x 30	6- 50	1.4	403.396	40.00	403.390	55.00	403.380	77.00
150 x 50 x 40	8- 60	3.6	403.397	56.00	403.391	77.00	403.381	122.00
High-quality gray cast iron:								
200 x 70 x 50	8- 75	6.1	403.398	95.00	403.392	124.00	403.382	189.00
250 x 85 x 60	10- 100	10	403.399	160.00	403.395	226.00	403.383	260.00
300 x 100 x 70	15- 120	15	403.400	213.00	403.393	313.00	403.384	379.00

X-blocks in pairs

The X-blocks have four V-grooves of 90°, all varying in size.

- **Class 1:** Parallelism: 16 µm.
Flatness of the measuring faces according to DIN 876/1.
All surfaces hand scraped.
- **Class 0:** Parallelism: 8 µm.
Flatness of the measuring faces according to DIN 876/0.
All surfaces fine scraped.
- All four V-grooves are ground in matched pairs.
- Material: high-quality gray cast iron.
- V-groove: 90°.
- Holds workpieces on all faces.



Dimensions $l \times w \times h$ mm	Capa- city ϕ /mm	Weight p. pair kg	Class 1		Class 0	
			Item No.	Price EUR p. pair	Item No.	Price EUR p. pair
120 x 100 x 60	8- 90	6	403.370	178.00	403.360	213.00
150 x 130 x 75	8- 110	10.4	403.371	249.00	403.361	296.00
200 x 170 x 90	8- 150	25	403.372	385.00	403.362	462.00



Magnetic V-blocks

- Accuracy: ± 0.02 mm / 100 mm.
- On/off switch.
- V-groove: 90° .



Item No.	Dimensions <i>l x w x h</i> /mm	Capacity ϕ /mm	Magnetic force/N	Weight kg	Price EUR
906.207	70 x 60 x 72	8 - 50	686	1.8	42.00
906.208	100 x 70 x 95	6 - 55	1178	3.7	71.00



Magnetic V-blocks

- Magnetic force: 200 N.
- Ground in matched pairs.
- V-groove: 90° .
- Weight: 2.2 kg (per piece).



Item No.	Dimensions <i>l x w x h</i> /mm	Capacity ϕ /mm	Price EUR
906.210	100 x 50 x 80	6 - 70	223.00



Magnetic V-block

- V-groove: 90° .
- Magnetic force of round spindle axis in V-groove: 450 N, magnetic force of base plate: 450 N.



Item No.	Dimensions <i>l x w x h</i> /mm	Capacity ϕ /mm	Price EUR
855.200	125 x 60 x 73	6 - 50	294.00



Adjustable V-blocks

V-blocks adjustable from 0 to +60 degrees and 0 to -15 degrees. Suitable for metal cutting machines and for various measuring purposes.



Item No.	Dimensions l x w x h/mm	Price EUR
906.600	75 x 25 x 32.5	51.00
906.601	102 x 30 x 48	51.00
906.602	102 x 46 x 48	59.00

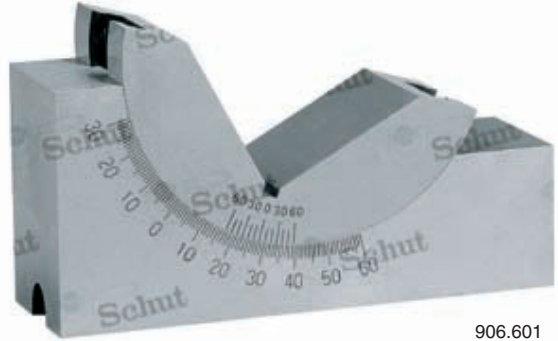

906.601

V-blocks in pairs

- Parallelism measuring faces: $\pm 4 \mu\text{m}$.
- Squareness of front face with bottom face according DIN 2274.
- Hardened ($650 \pm 100 \text{ HV5}$).
- Ground in matched pairs.
- V-groove: 90° .
- Delivery incl. clamp.



666.550

Item No.	Dimensions l x w x h/mm	Capacity ϕ /mm	Price EUR
666.550	50 x 40 x 40	5 - 30	111.00
666.551	75 x 55 x 55	5 - 50	170.00
666.552	100 x 75 x 75	7 - 70	263.00

V-blocks in pairs

- Parallelism measuring faces: $\pm 4 \mu\text{m}$.
- Squareness of all side faces with each other according DIN 2274.
- Hardened ($650 \pm 100 \text{ HV5}$).
- Ground in matched pairs.
- V-groove: 90° .
- Delivery incl. clamp.



666.540

Item No.	Dimensions l x w x h/mm	Capacity ϕ /mm	Price EUR
666.540	60 x 58 x 40	5 - 30	142.00
666.541	75 x 70 x 54	5 - 50	217.00
666.542	100 x 96 x 75	7 - 70	328.00

Granite V-blocks in pairs

- V-groove: 90°.
- Material: granite.
- Processed in matched pairs.
- Delivery in a aluminum case (except 402.158/162).
- Delivery with an inspection report.

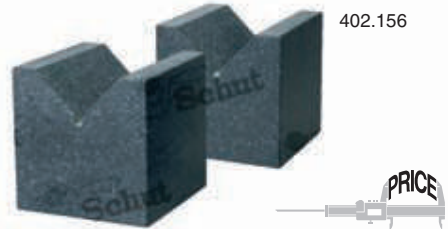
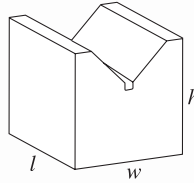

Dimensions <i>l x w x h</i> /mm	Capacity ϕ /mm	Weight kg ¹	Item No.	Accuracy μm^2	Price EUR	Item No.	Accuracy μm^2	Price EUR
			Class 1:			Class 0:		
63 x 63 x 63	10- 50	1.4	402.155	± 6	359.00	402.159	± 3	407.00
100 x 100 x 100	15- 75	5.6	402.156	± 8	440.00	402.160	± 4	541.00
100 x 160 x 160	25- 125	14.2	402.157	± 8	642.00	402.161	± 4	760.00
160 x 250 x 250	60- 200	55.2	402.158	± 10	855.00	402.162	± 5	997.00

¹ Weight per pair.

² Parallelism between measuring faces and base.

Magnetic induction blocks in pairs

These magnetic induction blocks are not magnetized themselves. They are placed on a magnetic chuck to induce, to hold objects as for example round bars.

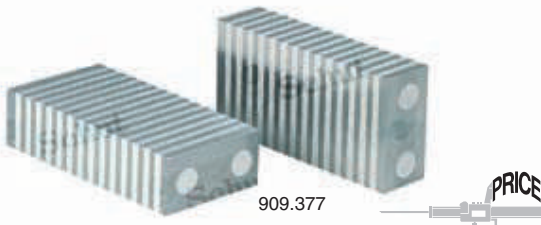

- Material: steel and aluminum alloy.
- Ground in matched pairs.

V-blocks (909.378)

- Capacity: $\phi 7 - 50$ mm.
- V-groove: 90°.



Item No.	Dimensions <i>l x w x h</i> /mm	Weight kg	Price EUR
909.377	100 x 50 x 25	1.18	41.00
909.378	50 x 60 x 48	1.13	46.00

Magnetic holders

- Angles 45°, 90° and 135°.

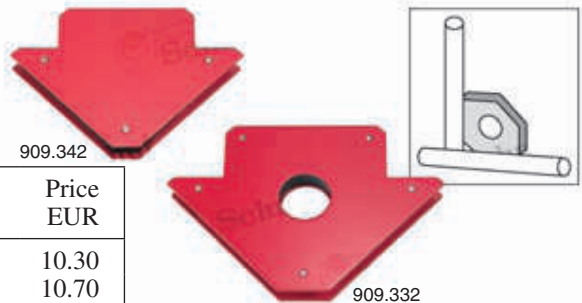

Item No.	Dimensions <i>h x w</i> /mm	Thickness mm	Holding power/kg	Price EUR
909.342	80 x 120	14	2.5	10.30
909.332	100 x 155	17	8	10.70

Precision vises

Hardened precision vises for accurate measurements and machine operations.

- Accuracy (parallelism, flatness and squareness):
 ≤100 mm jaw opening = 0.005 mm,
 >100 mm jaw opening = 0.005 mm per 100 mm.
- With horizontally and vertically ground prism in the moveable jaw.



909.734



909.739

Precision and universal sine vises

- Stable and accurate to fix in each angle position (0 to 45°).

Universal precision vise

- With 360° rotatable base.
- Accurate degree scale.
- Stable and accurate to fix in each angle position (0 to 45°).



909.746

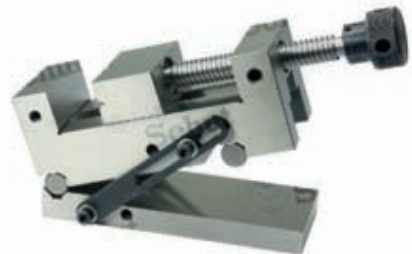

909.749



909.752



Item No.	Jaw opening mm	Jaw width mm	Jaw depth mm	Length mm	Price EUR
Precision vises:					
909.733	60	50	25	150	69.00
909.734	100	75	35	200	100.00
909.735	120	100	45	250	190.00
909.736	155	125	50	300	271.00
909.737	25	25	10	65	36.70
909.738	65	50	25	140	53.00
909.739	100	75	35	190	71.00
909.740	120	100	45	240	142.00
909.741	155	125	50	280	212.00
Precision sine vises with swivelling front axis:					
909.742	60	50	25	140	96.00
909.743	100	75	35	190	154.00
909.744	120	100	45	250	276.00
Precision sine vises with swivelling rear axis:					
909.745	60	50	25	140	101.00
909.746	100	75	35	190	156.00
909.747	120	100	45	250	278.00
Universal sine vises:					
909.748	60	50	25	140	134.00
909.749	100	75	35	200	203.00
909.750	120	100	45	250	337.00
909.751	155	125	50	300	475.00
Universal precision vise:					
909.752	80	70	30	–	804.00



Modular precision vises

Hardened precision vises for fixation for various machine operations.

- With or without 90° rotatable base.
- Accuracy (parallelism, flatness and squareness):
 - ≤ 100 mm jaw opening = 0.005 mm,
 - > 100 mm jaw opening = 0.005 mm per 100 mm.
- Also available:
 - intermediate sizes with other jaw depths and jaw openings,
 - larger models with jaw width 200 or 300 mm and jaw opening up to 600 mm.

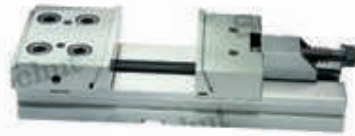

909.702



909.706



Jaw opening mm	Jaw width mm	Jaw depth mm	Length mm	Without rotatable base		With rotatable base	
				Item No.	Price EUR	Item No.	Price EUR
100	100	30	270	909.702	515.00	909.706	718.00
150	125	40	345	909.703	656.00	909.707	935.00
200	150	50	420	909.704	775.00	909.708	1,094.00
400	175	60	655	909.705	1,189.00	909.709	1,547.00



Long modular vises

Long hardened vises for fixation for various machine operations.

- Single or two-sided model.
- Also available:
 - intermediate sizes with other jaw depths and jaw openings,
 - larger models with jaw width 200 mm and jaw opening up to 700 mm (single) or 250 mm (two-sided).



909.710



909.714



Jaw width mm	Jaw depth mm	Length mm	Single			Two-sided		
			Item No.	Jaw opening/mm	Price EUR	Item No.	Jaw opening/mm	Price EUR
100	30	460	909.710	290	673.00	909.714	90	761.00
125	40	520	909.711	320	744.00	909.715	100	829.00
150	50	580	909.712	360	1,102.00	–	–	–
150	50	680	–	–	–	909.716	160	1,364.00
175	60	866	909.713	600	1,653.00	909.717	220	1,873.00

Short modular vises

Short hardened vises for fixation for various machine operations.

- With fixed jaw, fixed double jaw or moveable jaw.



909.723



909.728



909.718



Jaw width mm	Jaw depth mm	Length mm	Height mm	Fixed jaw		Fixed double jaw		Moveable jaw	
				Item No.	Price EUR	Item No.	Price EUR	Item No.	Price EUR
100	30	140	65	909.723	156.00	909.728	184.00	909.718	193.00
125	40	160	80	909.724	165.00	909.729	210.00	909.719	220.00
150	50	230	100	909.725	254.00	909.730	315.00	909.720	331.00
175	60	240	118	909.726	331.00	909.731	413.00	909.721	412.00
200	65	300	135	909.727	455.00	909.732	551.00	909.722	551.00

Precision sine plates

- Stable and accurate to fix in each angle position (0 to 45°).

Precision sine plates

- Accuracy (parallelism and squareness):
 ≤ 100 mm dimension l or $w = 0.005$ mm,
 > 100 mm dimension l or $w = 0.005$ mm per 100 mm.
- Mounting hole pattern 909.690: 13x M5,
 909.691: 23x M5.



Magnetic precision sine plates

Permanently magnetic sine plates for positioning and holding small or odd-shaped workpieces.

- Center distance of the support cylinders:
 909.692: 76 mm,
 909.693: 127 mm.



909.690



909.692



Item No.	Dimensions/mm	Price EUR
Precision sine plates:		
909.690	100 x 100 x 50	133.00
909.691	152 x 152 x 57	156.00
Magnetic precision sine plates:		
909.692	100 x 100 x 117	367.00
909.693	152 x 152 x 117	459.00

Granite square blocks with V-nut and tapped holes

Multifunctional granite blocks for e.g. flatness and squareness measurements, with V-nut and several tapped holes. Hold workpieces on several faces.

- Accuracy measuring faces:
 - flatness conforms to DIN 876/0,
 - squareness conforms to DIN 875/1.
- Screw thread of tapping holes:
 - 402.170: M6, 402.171/172: M8.
- Equilateral cubic.



402.170

Item No.	Dimensions mm	Flatness µm	Squareness µm	Weight kg	Price EUR
402.170 ¹	160 x 160 x 160	4	8	9.6	569.00
402.171	200 x 200 x 200	5	9	17	876.00
402.172	250 x 250 x 250	5	10	34	1,300.00

¹ Delivery with an inspection report.

Four-sided cast iron parallel blocks in pairs

Hollow but yet stable cast iron parallel blocks because of the internal bridge construction.

- **Class 3:** Parallelism: 64 µm. Smooth planed.
- **Class 1:** Parallelism: 16 µm. Hand scraped.
- **Class 0:** Parallelism: 8 µm. Fine scraped.
- Flatness conforms to DIN 876.
- Squareness conforms to DIN 875.
- Plan parallel and square matched in pairs.



403.622

Dimensions <i>l x w x h</i> /mm	Weight p. pair/kg	Class 3		Class 1		Class 0	
		Item No.	Price EUR	Item No.	Price EUR	Item No.	Price EUR
150 x 150 x 100	18	403.628	383.00	403.624	634.00	403.620	758.00
200 x 150 x 100	28	403.629	528.00	403.625	820.00	403.621	1,038.00
300 x 225 x 150	60	403.630	772.00	403.626	1,399.00	403.622	1,683.00
400 x 300 x 200	140	403.631	1,472.00	403.627	2,670.00	403.623	3,210.00

Cast iron angle blocks with several clamping possibilities

Cast iron angle block, with four clamping faces with several slots and taps, for aligning and clamping of tools and products. The four faces are planparallel and square matched.

- Slot width: 18 mm (403.607: 20 mm).

Item No.	Dimensions <i>l x w x h</i> /mm	Parallelism µm	Squareness µm	Weight kg	Price EUR
403.605	250 x 150 x 100	50	35	13	209.00
403.606	300 x 200 x 150	52	40	23	390.00
403.607	400 x 250 x 200	56	46	55	583.00



403.606

Cast iron clamping tables with several clamping possibilities

These cast iron clamping tables offer many possibilities for aligning and clamping products for mechanical processing. The six faces are parallel and square milled. Four of these faces are equipped with several clamping slots and the top face with T-slots.

- Flatness according DIN 876/3.
- T-slots according DIN 650.



403.613



Item No.	Dimensions <i>l x w x h</i> /mm	Weight kg	Nom. value T-slots/mm	Slot width mm	Price EUR
403.610	250 x 180 x 150	25	14	16	417.00
403.611	300 x 220 x 200	37	14	18	582.00
403.612	350 x 280 x 250	70	22	22	784.00
403.613	400 x 350 x 300	115	22	22	1,018.00
403.614	500 x 450 x 400	180	22	22	1,318.00
403.615	800 x 700 x 600	670	28	30	3,400.00

Cast iron angle plates with several clamping slots

These cast iron angle plates have several clamping slots both in the base and the clamping face, which make them suitable for all kind of fixtures.

- Flatness according DIN 876.
- Squareness according DIN 875.
- Strengthened outsides.
- Slots in base and clamping face.



403.283

Item No.	Dimensions <i>l x w x h</i> /mm	Weight kg	Flatness and square- ness/ μ m	Price EUR
Class 3, DIN 876/3, DIN 875/2:				
403.292	150 x 75 x 100	4	30	77.00
403.293	200 x 100 x 150	8	30	107.00
403.294	275 x 150 x 200	20	40	189.00
403.295	300 x 150 x 250	24	45	219.00
403.296	400 x 225 x 300	45	50	344.00
403.297	500 x 300 x 400	85	60	545.00
Class 1, DIN 876/2, DIN 875/1:				
403.286	150 x 75 x 100	4	15	113.00
403.287	200 x 100 x 150	8	15	179.00
403.288	275 x 150 x 200	20	20	284.00
403.289	300 x 150 x 250	24	22	355.00
403.290	400 x 225 x 300	45	25	592.00
403.291	500 x 300 x 400	85	30	936.00
Class 0, DIN 876/1, DIN 875/0:				
403.280	150 x 75 x 100	4	7	155.00
403.281	200 x 100 x 150	8	7	226.00
403.282	275 x 150 x 200	20	9	350.00
403.283	300 x 150 x 250	24	11	528.00
403.284	400 x 225 x 300	45	12	771.00
403.285	500 x 300 x 400	85	15	1,244.00

Cast iron angle plates

- Ground faces.
- With T-slots.
- Accuracy: flatness according DIN 876, squareness according DIN 875.



Dimensions <i>l x w x h</i> /mm	Weight kg	DIN 876/3 and 875/2		DIN 876/2 and 875/1		DIN 876/1 and 875/0	
		Item No.	Price EUR	Item No.	Price EUR	Item No.	Price EUR
150 x 75 x 100	6	403.264	106.00	403.261	138.00	403.267	174.00
200 x 100 x 150	11	403.276	138.00	403.273	201.00	403.270	244.00
275 x 150 x 200	24	403.265	244.00	403.262	327.00	403.268	385.00
300 x 150 x 250	33	403.277	301.00	403.274	455.00	403.271	626.00
400 x 225 x 300	54	403.266	444.00	403.263	655.00	403.269	824.00
500 x 300 x 400	105	403.278	718.00	403.275	1,067.00	403.272	1,331.00

Steel cylindrical squares

Ground and lapped steel cylinder for checking squareness e.g. during the acceptance process of machines and instruments. Cylindricity error max. 1.5 μm .

Item No.	Dimensions mm	Squareness p-p/ μm	Price EUR
852.190	$\varnothing 90 \times 200$	2	479.00
852.191	$\varnothing 90 \times 250$	2.2	525.00
852.192	$\varnothing 90 \times 300$	2.5	561.00
852.193	$\varnothing 90 \times 350$	2.8	607.00
852.194	$\varnothing 90 \times 400$	3	638.00



Steel cylindrical squares

Ground and lapped steel cylinder for checking squareness. Out of roundness $\leq 5 \mu\text{m}$.

Item No.	Dimensions mm	Squareness p-p/ μm	Price EUR
906.436	$\varnothing 80 \times 200$	3	202.00
906.437	$\varnothing 80 \times 315$	4	229.00
906.438	$\varnothing 100 \times 500$	5	447.00
906.439	$\varnothing 140 \times 800$	7	851.00



Granite squares

- Triangular model.
- Material: granite.
- Straight beveled edges.
- With weight-saving holes (except 402.120/126).
- Delivery with an inspection report.

PRICE



402.123

Item No.	Dimensions <i>h x w x t</i> /mm	Squareness ¹ μm	Flatness ² μm	Weight kg	Price EUR
DIN 875/0:					
402.120	100 x 63 x 16	±4	2	0.3	78.00
402.121	160 x 100 x 20	±4	2	0.8	113.00
402.122	250 x 160 x 25	±5	2	2.4	126.00
402.123	400 x 250 x 40	±7	2.5	7.5	226.00
402.124	630 x 400 x 63	±9	3	25.5	539.00
402.125 ³	1000 x 630 x 80	±12	5	102	1,150.00
DIN 875/00:					
402.126	100 x 63 x 16	±2	1	0.3	100.00
402.127	160 x 100 x 20	±2	1	0.8	143.00
402.128	250 x 160 x 25	±2.5	1	2.4	163.00
402.129	400 x 250 x 40	±3.5	1.2	7.5	283.00
402.130	630 x 400 x 63	±4.5	1.5	25.5	656.00
402.131 ³	1000 x 630 x 80	±6	2.5	102	1,450.00

¹ Squareness between measuring face and base.² Flatness of measuring face and base.³ Weight included package.

Granite squares

- Square model.
- Material: granite.
- Straight beveled edges.
- With weight-saving holes.
- Delivery with an inspection report.



PRICE

Item No.	Dimensions <i>h x w x t</i> /mm	Squareness μm ¹	Weight kg	Price EUR
Class 0:				
402.145	200 x 200 x 25	±4	2.6	304.00
402.146	250 x 250 x 30	±4.5	4.9	380.00
402.147	315 x 315 x 30	±5.2	7.7	522.00
402.148	400 x 400 x 40	±6	14.5	687.00
402.149	500 x 500 x 50	±7	33	954.00
Class 00:				
402.150	200 x 200 x 25	±2	2.6	376.00
402.151	250 x 250 x 30	±2.2	4.9	450.00
402.152	315 x 315 x 30	±2.6	7.7	617.00
402.153	400 x 400 x 40	±3	14.5	830.00
402.154	500 x 500 x 50	±3.5	33	1,150.00

¹ Squareness between adjacent measuring faces.

402.146

Ceramic squares

- Made of alumina ceramics.



908.745

PRICE

Item No.	Dimensions <i>l x w x t</i> /mm	Flatness long measuring face/mm	Flatness short measuring face/mm	Squareness mm	Price EUR
Triangular, class A:					
908.718	100 x 63 x 16	0.001	0.001	0.004	102.00
908.719	160 x 100 x 20	0.002	0.001	0.004	287.00
908.720	250 x 160 x 25	0.002	0.002	0.005	819.00
908.721	400 x 250 x 40	0.0025	0.002	0.007	1,843.00
908.722	630 x 400 x 63	0.003	0.0025	0.009	3,070.00
Triangular, class AAA:					
908.726	250 x 160 x 25	0.0005	0.0005	0.0025	1,035.00
908.727	400 x 250 x 40	0.0005	0.0005	0.0035	2,280.00
908.728	630 x 400 x 63	0.0008	0.0005	0.0045	3,880.00

Item No.	Dimensions <i>l x w x t</i> mm	Flatness measuring faces/mm	Squareness measuring faces/mm	side faces/mm	Parallelism measuring faces/mm	side faces/mm	Price EUR
Rectangular, class A:							
908.742	200 x 200 x 25	0.0018	0.004	0.04	0.004	0.096	819.00
908.745	400 x 400 x 40	0.0026	0.006	0.06	0.006	0.144	2,010.00
Rectangular, class AAA:							
908.781	250 x 250 x 30	0.0005	0.0011	0.011	0.0011	0.027	1,250.00
908.782	300 x 300 x 30	0.0006	0.0013	0.013	0.0013	0.031	1,767.00

Flat steel squares

- Lapped measuring faces.
- Accuracy according DIN 875.



670.003

Item No.	Dimensions mm	Cross- section/mm	Price EUR
Class III:			
670.061	100 x 70	20 x 5	6.00
670.062	150 x 100	25 x 5	7.70
670.064	250 x 165	35 x 7	13.30
670.065	300 x 175	35 x 7	17.90
670.066	400 x 200	35 x 7	25.00
670.067	500 x 250	40 x 8	40.00
670.068	600 x 300	40 x 8	47.00
670.070 ²	1000 x 500	50 x 10	91.00
DIN 875/2:			
670.041	75 x 50	15 x 5	5.80
670.042	100 x 70	20 x 5	6.50
670.043	150 x 100	25 x 5	8.30
670.044	200 x 130	30 x 6	11.30
670.045	250 x 165	35 x 7	14.40
670.046	300 x 175	35 x 7	19.10
670.047	400 x 200	35 x 7	29.10
670.048	500 x 250	40 x 8	43.00
670.049 ¹	600 x 300	40 x 8	79.00
670.051 ^{1,2}	1000 x 500	50 x 10	131.00

Item No.	Dimensions mm	Cross- section/mm	Price EUR
DIN 875/1:			
670.022	75 x 50	15 x 5	7.10
670.023	100 x 70	20 x 5	8.00
670.024	150 x 100	25 x 5	9.70
670.025	200 x 130	30 x 6	13.50
670.026	250 x 165	35 x 7	18.60
670.027	300 x 200	40 x 8	27.30
670.028	400 x 265	45 x 10	58.00
670.029	500 x 330	50 x 10	83.00
670.030 ¹	600 x 400	50 x 10	149.00
DIN 875/0 (with inspection report):			
670.002	75 x 50	15 x 5	11.50
670.003	100 x 70	20 x 5	14.20
670.004	150 x 100	25 x 5	16.80
670.005	200 x 130	30 x 6	27.30
670.006	250 x 165	35 x 7	42.00
670.007	300 x 200	40 x 8	54.00
670.008	400 x 265	45 x 10	114.00
670.009	500 x 330	50 x 10	140.00

¹ Incl. transport package.

² Delivery ex Groningen, Netherlands.

Flat stainless steel squares

Item No.	Dimensions mm	Cross- section/mm	Price EUR
DIN 875/2:			
670.142	75 x 50	15 x 5	7.20
670.143	100 x 70	20 x 5	9.10
670.144	150 x 100	25 x 5	12.30
670.145	200 x 130	30 x 6	18.50
670.146	250 x 165	35 x 7	33.90
670.147	300 x 200	35 x 7	46.00
DIN 875/1:			
670.122	75 x 50	15 x 5	7.90
670.123	100 x 70	20 x 5	10.00
670.124	150 x 100	25 x 5	14.00
670.125	200 x 130	30 x 6	20.60
670.126	250 x 165	35 x 7	37.30
670.127	300 x 200	40 x 8	50.00
670.128	400 x 265	45 x 10	134.00
670.129	500 x 330	50 x 10	168.00
670.130 ¹	600 x 400	50 x 10	319.00
DIN 875/0, hardened (with inspection report):			
670.751	50 x 40	15 x 5	13.90
670.752	75 x 50	15 x 5	24.00
670.753	100 x 70	20 x 5	30.30
670.754	150 x 100	25 x 5	38.30
670.755	200 x 130	30 x 6	55.00
670.758	250 x 165	35 x 7	63.00
670.759	300 x 200	40 x 8	87.00
670.760	400 x 265	45 x 10	166.00
670.761	500 x 330	50 x 10	208.00

- Hardened stainless steel.
- Lapped measuring faces.
- Accuracy according DIN 875.



670.753

¹ Incl. transport package.

Wooden cases for squares

Wooden cases for flat squares.



670.466



Item No.	Dimensions square/mm	Price EUR
670.463	50 x 40	7.60
670.464	75 x 50	7.80
670.465	100 x 70	8.60
670.466	150 x 100	11.10
670.467	200 x 130	13.50
670.468	250 x 165	33.30
670.468	300 x 200	33.30
670.469	400 x 265	52.00
670.470	500 x 330	71.00

Flat stainless steel squares

- Hardened stainless steel.
- Lapped measuring faces.
- Accuracy according DIN 875.

Item No.	Dimensions mm	Cross- section/mm	Price EUR
DIN 875/1:			
907.301	75 x 50	15 x 5	8.30
907.302	100 x 70	20 x 5	10.60
907.303	150 x 100	25 x 5	14.10
907.304	200 x 130	30 x 6	20.10
907.305	250 x 160	35 x 7	27.50
907.306	300 x 200	40 x 8	37.30
DIN 875/0:			
907.282	50 x 40	12 x 3.5	13.10
907.283	75 x 50	15 x 5	13.70
907.284	100 x 70	20 x 5	16.50
907.285	150 x 100	25 x 7	22.70
907.286	200 x 130	30 x 7	29.40



907.284



PRICE

Flat steel squares



907.362



907.409

Item No.	Dimensions mm	Cross- section/mm	Price EUR
Acute angle squares 45°, DIN 875/2:			
907.359	100 x 70	20 x 5	13.50
907.360	120 x 80	20 x 5	12.90
907.361	150 x 100	20 x 5	14.60
907.362	200 x 130	25 x 5	22.00
Acute angle squares 60°, DIN 875/2:			
907.383	100 x 70	20 x 5	10.70
907.384	120 x 80	20 x 5	12.90
907.385	150 x 100	20 x 5	13.50
907.386	200 x 130	25 x 5	16.30
Hexagon squares 120°, DIN 875/2:			
907.407	50 x 50	15 x 5	8.50
907.408	75 x 75	18 x 5	10.10
907.409	100 x 100	20 x 5	12.50
907.410	150 x 150	25 x 5	16.10
907.411	200 x 200	30 x 6	18.40
Octagon squares 135°, DIN 875/2:			
907.417	50 x 50	15 x 5	11.60
907.418	75 x 75	18 x 5	13.70
907.419	100 x 100	20 x 5	16.10
907.420	150 x 150	25 x 5	20.80
907.421	200 x 200	30 x 6	24.20

PRICE

Steel squares with base

- Lapped measuring faces.
- Accuracy according DIN 875.



670.203

Item No.	Dimensions mm	Cross- section/mm	Price EUR
Class III:			
670.261	100 x 70	20 x 5	8.20
670.262	150 x 100	25 x 5	9.50
670.263	200 x 130	30 x 6	13.70
670.264	250 x 165	35 x 7	17.60
670.265	300 x 175	35 x 7	24.80
670.266	400 x 200	35 x 7	38.40
670.267	500 x 250	40 x 8	52.00
670.268	600 x 300	40 x 8	59.00
670.270 ²	1000 x 500	50 x 10	115.00
DIN 875/2:			
670.241	75 x 50	15 x 5	7.70
670.242	100 x 70	20 x 5	9.00
670.243	150 x 100	25 x 5	13.10
670.244	200 x 130	30 x 6	16.00
670.245	250 x 165	35 x 7	21.20
670.246	300 x 175	35 x 7	27.50
670.247	400 x 200	35 x 7	44.00
670.248	500 x 250	40 x 8	58.00
670.249 ¹	600 x 300	40 x 8	96.00
670.250 ¹	750 x 375	45 x 10	121.00
670.251 ^{1,2}	1000 x 500	50 x 10	169.00

Item No.	Dimensions mm	Cross- section/mm	Price EUR
DIN 875/1:			
670.222	75 x 50	15 x 5	9.50
670.223	100 x 70	20 x 5	11.10
670.224	150 x 100	25 x 5	16.00
670.225	200 x 130	30 x 6	20.00
670.226	250 x 165	35 x 7	27.70
670.227	300 x 200	40 x 8	35.90
670.228	400 x 265	45 x 10	84.00
670.229	500 x 330	50 x 10	124.00
670.230 ¹	600 x 400	50 x 10	207.00
DIN 875/0 (with inspection report):			
670.202	75 x 50	15 x 5	18.80
670.203	100 x 70	20 x 5	22.40
670.204	150 x 100	25 x 5	30.80
670.205	200 x 130	30 x 6	43.00
670.206	250 x 165	35 x 7	66.00
670.207	300 x 200	40 x 8	87.00
670.208	400 x 265	45 x 10	177.00
670.209	500 x 330	50 x 10	244.00

¹ Incl. transport package.

² Delivery ex Groningen, Netherlands.

Stainless steel squares with base

Item No.	Dimensions mm	Cross- section/mm	Price EUR
DIN 875/2:			
670.342	75 x 50	15 x 5	13.10
670.343	100 x 70	20 x 5	16.10
670.344	150 x 100	25 x 5	24.60
670.345	200 x 130	30 x 6	33.10
670.346	250 x 165	35 x 7	45.00
670.347	300 x 200	35 x 7	54.00
DIN 875/1:			
670.322	75 x 50	15 x 5	14.70
670.323	100 x 70	20 x 5	18.30
670.324	150 x 100	25 x 5	28.80
670.325	200 x 130	30 x 6	37.30
670.326	250 x 165	35 x 7	50.00
670.327	300 x 200	40 x 8	56.00
670.328	400 x 265	45 x 10	175.00
670.329	500 x 330	50 x 10	220.00
670.330 ¹	600 x 400	50 x 10	406.00
DIN 875/0, hardened (with inspection report):			
670.851	50 x 40	15 x 5	22.80
670.852	75 x 50	15 x 5	26.80
670.853	100 x 70	20 x 5	28.90
670.854	150 x 100	25 x 5	46.00
670.855	200 x 130	30 x 6	71.00
670.762	250 x 165	35 x 7	118.00
670.763	300 x 200	40 x 8	123.00
670.764	400 x 265	45 x 10	227.00
670.765	500 x 330	50 x 10	302.00

¹ Incl. transport package.

- Hardened stainless steel.
- Lapped measuring faces.
- Accuracy according DIN 875.



670.323

All squares can be delivered with an inspection report or a certificate of a recognized measuring laboratory.

For the larger squares it is important to realize that external factors affect the stability of squares, which may influence the accuracy unfavourably.

Wooden cases for squares

Wooden cases for squares with base.



670.884



Item No.	Dimensions square/mm	Price EUR
670.463	50 x 40	7.60
670.464	75 x 50	7.80
670.465	100 x 70	8.60
670.884	150 x 100	11.60
670.885	200 x 130	13.00
670.887	250 x 165	44.00
670.887	300 x 200	44.00
670.888	400 x 265	58.00
670.889	500 x 330	77.00

Stainless steel squares with base

- Hardened stainless steel.
- Lapped measuring faces.
- Accuracy according DIN 875.

Item No.	Dimensions mm	Cross- section/mm	Price EUR
DIN 875/1:			
907.287	75 x 50	15 x 5	10.50
907.288	100 x 70	20 x 5	13.00
907.289	150 x 100	25 x 5	16.60
907.290	200 x 130	30 x 6	34.30
907.291	250 x 160	35 x 7	44.00
907.292	300 x 200	40 x 8	58.00
DIN 875/0:			
907.272	50 x 40	12 x 5	17.30
907.273	75 x 50	15 x 5	18.00
907.274	100 x 70	20 x 5	22.30
907.275	150 x 100	25 x 5	32.60
907.276	200 x 130	30 x 6	42.00



907.274



Steel squares with base



907.368



907.429



Item No.	Dimensions mm	Cross- section/mm	Price EUR
Acute angle squares 45°, DIN 875/2:			
907.365	100 x 70	20 x 5	14.50
907.366	120 x 80	20 x 5	13.70
907.367	150 x 100	20 x 5	22.00
907.368	200 x 130	25 x 5	23.20
Acute angle squares 60°, DIN 875/2:			
907.389	100 x 70	20 x 5	13.00
907.390	120 x 80	20 x 5	13.70
907.391	150 x 100	20 x 5	16.30
907.392	200 x 130	25 x 5	23.20
Mitre squares 135°, DIN 875/2:			
907.427	100 x 70	20 x 5	12.40
907.428	120 x 80	20 x 5	13.70
907.429	150 x 100	20 x 5	17.10
907.430	200 x 130	25 x 5	22.20

Hardened stainless steel squares with heavy beam



670.604

Item No.	Dimensions mm	Cross- section/mm	Price EUR
With knife-edges (DIN 875/00):			
670.601	50 x 40	14 x 10/16 x 2	46.00
670.602	75 x 50	14 x 10/18 x 2	68.00
670.603	100 x 70	16 x 10/18 x 2	76.00
670.604	150 x 100	20 x 12/22 x 2	89.00
670.605	200 x 130	24 x 14/26 x 3	107.00

Flange squares (not standardized)

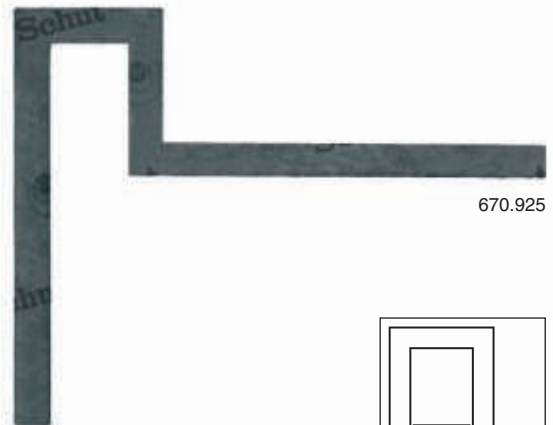
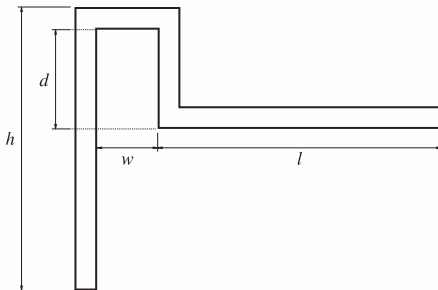

670.925

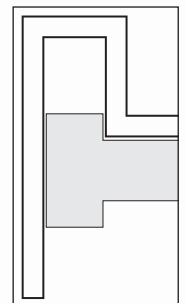

Item No.	Dimensions/mm				Price EUR
	l	h	w	d	
670.925	300	300	64	105	16.00
670.926	400	400	65	115	18.90
670.927	500	500	70	126	23.30
670.928	600	600	71	124	31.90

Adjustable squares

Precise base with sliding straight edge. The straight edge can be moved continuously along the base and can be firmly clamped by the spindle. All measuring faces are ground and the complete square is hardened. The adjustable straight edge enables working with for instance short edges and grooves.



Item No.	Dimensions straight edge/mm	Dimensions base/mm	Price EUR
907.874	60 x 4 x 4	23 x 40 x 10	68.00
909.407	125 x 8 x 8	30 x 75 x 12	138.00



907.874

Squares with heavy beam

- Hardened stainless steel.
- Lapped measuring faces.
- Accuracy according DIN 875/0.



Item No.	Dimensions mm	Cross- section/mm	Price EUR
907.262	50 x 40	14 x 10/16 x 2	34.60
907.263	75 x 50	14 x 10/16 x 2	39.60
907.264	100 x 70	18 x 12/20 x 3	42.00
907.265	150 x 100	24 x 14/25 x 3	63.00
907.266	200 x 130	28 x 16/30 x 4	92.00

907.264



Squares with heavy beam and knife-edges

- Hardened stainless steel.
- Lapped measuring faces.
- Accuracy according DIN 875/00.



Item No.	Dimensions mm	Cross- section/mm	Price EUR
907.245	50 x 40	14 x 10/16 x 2	39.20
907.246	75 x 50	14 x 10/16 x 2	42.00
907.247	100 x 70	18 x 12/20 x 3	55.00
907.248	150 x 100	24 x 14/25 x 3	83.00
907.249	200 x 130	28 x 16/30 x 4	103.00

907.247



Beveled edge squares

- Hardened stainless steel.
- Lapped measuring faces.
- Accuracy according DIN 875/00.



Item No.	Dimensions mm	Cross-section/mm	Price EUR
907.250	50 x 40	12 x 4	15.80
907.251	75 x 50	16 x 4	20.70
907.252	100 x 70	20 x 5	21.80
907.253	150 x 100	25 x 6	34.70
907.254	200 x 130	30 x 7	46.00



907.252

Beveled edge squares

- Hardened steel.
- Ground and lapped measuring faces.
- Accuracy according DIN 875/00.

Item No.	Dimensions/mm	Price EUR
Bright steel:		
670.403	50 x 40	19.10
670.404	75 x 50	22.40
670.405	100 x 70	26.40
670.406	150 x 100	36.60
670.407	200 x 130	50.00
Stainless steel:		
670.433	50 x 40	22.30
670.434	75 x 50	25.40
670.435	100 x 70	30.40
670.436	150 x 100	41.00
670.437	200 x 130	59.00



670.435

Toolmakers' squares

- Hardened stainless steel.
- Lapped measuring faces.
- Accuracy according DIN 875/00.



907.256



Item No.	Dimensions mm	Cross- section/mm	Price EUR
907.255	25 x 20	6 x 3.5/5 x 3.5	13.70
907.256	40 x 28	8 x 3.5/5 x 3.5	14.70

Toolmakers' squares

LMW flat beveled edge squares, with the knife-edge on the inside.



852.222

852.223

Item No.	Dimensions mm	Angle	Price EUR
852.220	25 x 20	90°	25.40
852.222	40 x 28	90°	26.00
852.223	40 x 28	89°30'	28.40
852.224	40 x 28	90°30'	27.30

Toolmakers' set

Consisting of:

- 1 beveled straight edge: 100 mm,
- 1 flat beveled edge square: 75 x 50 mm,
- 1 flat beveled edge square: 40 x 28 mm,
- 1 flat beveled edge square: 25 x 20 mm,
- 1 scriber: 8 x 8 x 60 mm.



Item No.	Description	Price EUR
852.201	Toolmakers' set	93.00

Sine bar

By means of a sine bar and with gauge blocks, a reference plane can be created ($l=150$ mm, $w=25$ mm) at an angle of 0° to 60° with respect to the base. The base of the sine bar consists of two rollers with a center to center distance of 127 ± 0.004 mm. In order to make a curve the gauge blocks are placed under one of the rollers.

- Straightness and parallelism: 5 μ m.

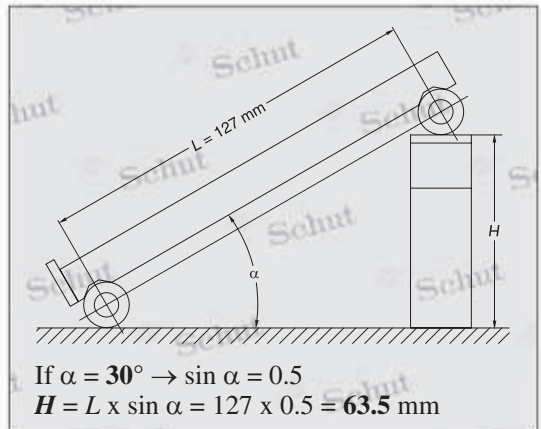

Item No.	Description	Price EUR
909.417	Sine bar	43.00

Steel parallel blocks

Parallels to position and layout workpieces in e.g. clamping jaws for drilling, grinding, milling and measuring. The workpieces and assemblies can easily be set up to the desired working height.

- Parallelism of the two measuring faces: ± 0.005 mm.
- Size deviation (height): ± 0.01 mm.
- Hardness: 55 HRC.
- Ground in matched pairs.
- Produced of a high-grade steel alloy.
- Delivery in a case with a manufacturer's certificate.



(Only available in sets.)

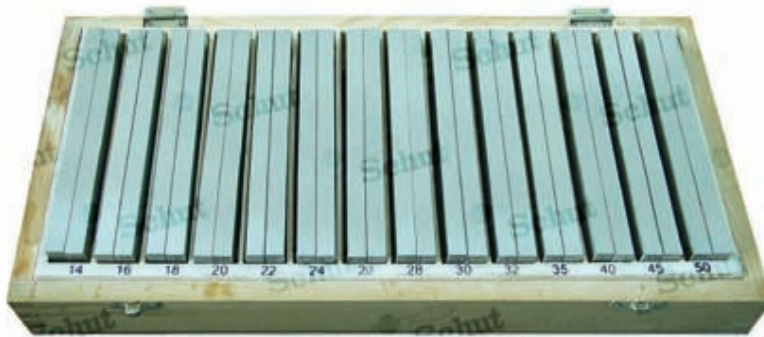

906.996



Item No.	Length mm	Price EUR	Width mm	Height mm
Set of 12 pairs:				
909.800	100	76.00	10	14 - 16 - 18 - 20 - 22 - 24 - 26 - 28 - 30 - 32 - 35 - 40
909.804	125	88.00		
906.995	150	104.00		
Set of 14 pairs:				
909.802	100	82.00	10	14 - 16 - 18 - 20 - 22 - 24 - 26 - 28 - 30 - 32 - 35 - 40 - 45 - 50
909.805	125	104.00		
906.996	150	117.00		
Set of 24 pairs:				
909.803	100	195.00	8	11 - 16 - 21 - 26 - 31 - 36
909.806	125	215.00	10	13 - 18 - 23 - 28 - 33 - 38
906.997	150	257.00	12	15 - 20 - 25 - 30 - 35 - 40
			14	17 - 22 - 27 - 32 - 37 - 42



Ceramic parallels in pairs

Parallels to position and layout workpieces in for example clamping jaws for drilling, grinding, milling and measuring.

- Made of alumina ceramics.



Item No.	Dimensions <i>l x w x h</i> /mm	Flatness measuring faces/mm	Parallelism measuring faces/mm	Squareness mm	Height difference/mm	Price EUR
Class A:						
908.732	250 x 40 x 25	0.004	0.004	0.020	0.004	862.00
908.733	400 x 63 x 40	0.008	0.008	0.030	0.008	1,940.00
Class AAA:						
908.737	250 x 40 x 25	0.002	0.002	0.010	0.002	1,190.00

Ceramic straight edges

- Made of alumina ceramics.



Item No.	Dimensions <i>l x w x h</i> /mm	Flatness measuring faces/mm	Parallelism measuring faces/mm	Squareness mm	Price EUR
Class AAA:					
908.789	400 x 60 x 25	0.0016	0.0024	0.008	905.00

Granite parallels in pairs

Flatness, parallelism and straightness of measuring surfaces according DIN 874.

- Material: granite.
- Straight beveled edges.
- Delivery with an inspection report.



Item No.	Flatness/ Parallelism μm^1	Price EUR	Item No.	Flatness/ Parallelism μm^1	Price EUR	Dimensions mm	Weight per pair kg
Class 0, 2-sided:			Class 00, 2-sided:				
402.104	± 3	146.00	402.112	± 1.5	179.00	160x 25 x 16	0.5
402.105	± 4	179.00	402.113	± 2	234.00	250x 40 x 25	1.6
402.106	± 8	256.00	402.114	± 4	318.00	400x 63 x 40	6.5
402.107	± 12	440.00	402.115	± 6	550.00	630x 100 x 63	24.7
Class 0, 4-sided:			Class 00, 4-sided:				
402.100	± 3	170.00	402.108	± 1.5	208.00	160x 25 x 16	0.5
402.101	± 4	220.00	402.109	± 2	277.00	250x 40 x 25	1.6
402.102	± 8	296.00	402.110	± 4	380.00	400x 63 x 40	6.5
402.103	± 12	495.00	402.111	± 6	646.00	630x 100 x 63	24.7

¹ Flatness and parallelism between opposite surfaces.

Granite straight edges

Flatness, parallelism and straightness of measuring surfaces according DIN 874.

- From length 1000 mm equipped with two bores.
- Material: granite.
- Straight beveled edges.
- Delivery with an inspection report.



Item No.	Dimensions mm	Weight kg	Straightness/ Flatness/ μm	Parallelism μm	Price EUR
Class 0:					
402.135	400 x 60 x 25	2	± 2.6	± 13	249.00
402.136	630 x 100 x 35	7	± 3.5	± 18	330.00
402.137	1000 x 160 x 50	27	± 5	± 25	653.00
402.138 ¹	1600 x 250 x 80	138	± 7.4	± 37	1,260.00
402.139 ¹	2000 x 300 x 100	210	± 9	± 45	1,855.00
Class 00:					
402.140	400 x 60 x 25	2	± 1.6	± 8	273.00
402.141	630 x 100 x 35	7	± 2.1	± 10.5	366.00
402.142	1000 x 160 x 50	27	± 3	± 15	729.00
402.143 ¹	1600 x 250 x 80	138	± 4.4	± 22	1,389.00
402.144 ¹	2000 x 300 x 100	210	± 5.4	± 27	2,060.00



¹ Weight included package.

Bright steel and stainless steel straight edges DIN 874/1 and 874/0

- Length: 500 - 6000 mm.
- Rectangular cross-section up to length 1500 mm, from length 2000 mm I-shaped with two grip slots.
- Flatness of the measuring faces according DIN 874.
- Straight edges of length 1000 mm and longer are marked on the side face at the Bessel points.



Bright steel

Item No.	Dimensions/mm	Price EUR
DIN 874/1:		
776.131	500 x 40 x 8	36.30
776.140	750 x 50 x 10	51.00
776.132	1000 x 50 x 10	70.00
776.133	1500 x 60 x 12	133.00
776.134	2000 x 70 x 15	337.00
776.135	2500 x 80 x 15	437.00
776.136	3000 x 100 x 16	648.00
776.137	4000 x 120 x 20	1,067.00
776.138	5000 x 140 x 20	1,810.00
776.139	6000 x 140 x 20	2,130.00
DIN 874/0:		
776.121	500 x 50 x 10	69.00
776.120	750 x 50 x 10	86.00
776.122	1000 x 60 x 12	134.00
776.123	1500 x 70 x 15	226.00
776.124	2000 x 80 x 15	404.00
776.125	2500 x 100 x 16	594.00
776.126	3000 x 120 x 20	878.00
776.127	4000 x 140 x 20	1,560.00
776.128	5000 x 140 x 20	1,922.00
776.129	6000 x 140 x 20	2,350.00

Stainless steel

Item No.	Dimensions/mm	Price EUR
DIN 874/1:		
776.231	500 x 40 x 8	50.00
776.374	750 x 50 x 10	74.00
776.232	1000 x 50 x 10	123.00
776.233	1500 x 60 x 12	245.00
776.234	2000 x 70 x 15	574.00
776.235	2500 x 80 x 15	743.00
DIN 874/0:		
776.221	500 x 50 x 10	89.00
776.130	750 x 50 x 10	118.00
776.222	1000 x 60 x 12	212.00
776.223	1500 x 70 x 15	353.00
776.224	2000 x 80 x 15	707.00



Bright steel and stainless steel straight edges DIN 874/2

- Length: 500 - 6000 mm.
- Rectangular cross-section up to length 3000 mm, from length 4000 mm I-shaped with two grip slots.
- Flatness according to DIN 874/2.

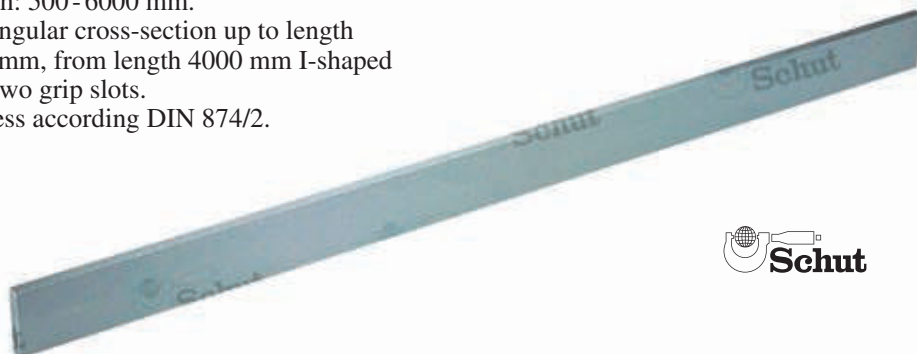

Bright steel

Item No.	Dimensions/mm	Price EUR
776.141	500 x 30 x 6	22.40
776.142	750 x 40 x 8	35.60
776.143	1000 x 40 x 8	44.00
776.144	1500 x 50 x 10	86.00
776.145	2000 x 60 x 12	115.00
776.146	2500 x 70 x 15	213.00
776.147	3000 x 80 x 15	321.00
776.148	4000 x 100 x 16	756.00
776.149	5000 x 120 x 20	1,212.00
776.150	6000 x 120 x 20	1,604.00

Stainless steel

Item No.	Dimensions/mm	Price EUR
776.388	500 x 30 x 6	31.80
776.389	750 x 40 x 8	56.00
776.380	1000 x 40 x 8	81.00
776.381	1500 x 50 x 10	169.00
776.382	2000 x 60 x 12	288.00
776.383	2500 x 70 x 15	462.00
776.384	3000 x 80 x 15	703.00
776.385	4000 x 100 x 16	1,660.00

Bright steel and stainless steel straight edges class 3

Class 3 straight edges are not standardized, i.e. there is no standard in which the accuracy classes are laid down. The accuracy is approximately maximum the double of the permissible error conform DIN 874/2.

Bright steel

Item No.	Dimensions/mm	Price EUR
776.151	500 x 30 x 6	16.50
776.152	750 x 30 x 6	23.50
776.153	1000 x 30 x 6	30.60
776.154	1500 x 40 x 8	47.00
776.155	2000 x 40 x 8	60.00
776.156	2500 x 40 x 8	87.00
776.157	3000 x 50 x 10	130.00
776.158	4000 x 60 x 12	248.00
776.159	5000 x 70 x 15	650.00
776.160	6000 x 80 x 15	931.00

Stainless steel

Item No.	Dimensions/mm	Price EUR
776.161	500 x 30 x 6	26.40
776.162	750 x 30 x 6	38.20
776.163	1000 x 30 x 6	54.00
776.164	1500 x 40 x 8	100.00
776.165	2000 x 40 x 8	127.00
776.166	2500 x 40 x 8	173.00
776.167	3000 x 50 x 10	271.00
776.168	4000 x 60 x 12	546.00
776.169	5000 x 70 x 15	1,239.00
776.170	6000 x 80 x 15	2,310.00

Aluminum straight edges

Light and therefore easy-to-use straight edges. Especially when using longer straight edges this is undoubtedly of great significance.

- Highly wear resistant.
- Highly corrosion resistant.
- Surface hardness: 500-550 HV.
- Highly insulating.
- With protective coating, thickness: 50 µm.
- With grip slots:
 - class 2: from length 2500 mm,
 - class 1 and 0: from length 1500 mm.
- Accuracy according DIN 874.



Item No.	Dimensions mm	Weight kg	Price EUR
DIN 874/2:			
776.191*	500 x 60 x 12	0.7	160.00
776.192*	1000 x 60 x 12	1.4	321.00
776.193*	1500 x 60 x 12	2.1	479.00
776.194*	2000 x 60 x 12	2.8	639.00
776.195	2500 x 100 x 16	7.2	960.00
776.196	3000 x 100 x 16	8.7	1,157.00
776.197	4000 x 100 x 16	11.6	1,542.00
776.198	5000 x 150 x 20	26.7	2,920.00
776.199	6000 x 150 x 20	32.1	3,510.00

Item No.	Dimensions mm	Weight kg	Price EUR
DIN 874/1:			
776.181*	500 x 60 x 12	0.7	182.00
776.182*	1000 x 60 x 12	1.4	364.00
776.183	1500 x 100 x 12	4.3	656.00
776.184	2000 x 100 x 12	5.8	875.00
776.185	2500 x 100 x 12	7.2	1,094.00
776.186	3000 x 150 x 20	15.9	1,858.00
776.187	4000 x 150 x 20	21.3	2,480.00
776.188	5000 x 150 x 20	26.7	3,100.00
776.189	6000 x 150 x 20	32.1	3,720.00

DIN 874/0:			
776.171*	500 x 60 x 12	0.7	208.00
776.172*	1000 x 60 x 12	1.4	423.00
776.173	1500 x 100 x 16	4.3	758.00
776.174	2000 x 100 x 16	5.8	1,015.00
776.175	2500 x 100 x 16	7.2	1,270.00
776.176	3000 x 150 x 20	15.9	2,220.00
776.177	4000 x 150 x 20	21.3	2,960.00
776.178	5000 x 150 x 20	26.7	3,700.00
776.179	6000 x 150 x 20	32.1	4,440.00



* Without grip slots.

Steel straight edges for mounting

I-shaped construction with wide and extra wide measuring faces for application of spirit levels.

- Length: 500 - 6000 mm.
- Flatness of the measuring faces according DIN 874.
- Larger sizes available on request.

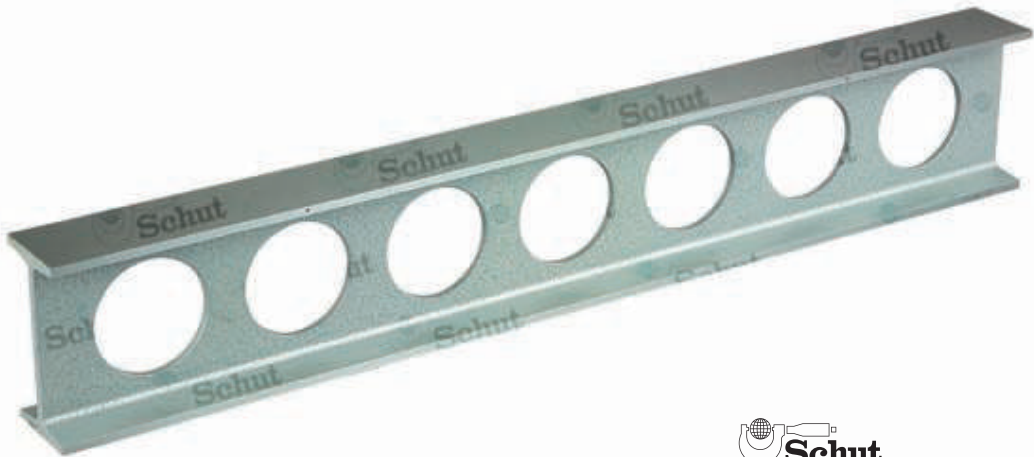

DIN 874/1

Item No.	Dimensions/mm	Price EUR
406.610	1000 x 100 x 30	350.00
406.615	1500 x 100 x 30	463.00
406.620	2000 x 120 x 40	624.00
406.625	2500 x 120 x 40	851.00
406.630	3000 x 140 x 40	1,066.00
406.640	4000 x 140 x 40	1,404.00
406.622	5000 x 160 x 40	2,320.00
406.641	6000 x 160 x 40	2,740.00
With extra wide measuring faces:		
406.636	500 x 80 x 40	254.00
406.637	750 x 80 x 40	282.00
406.614	1000 x 160 x 50	403.00
406.638	1500 x 160 x 50	578.00
406.643	2000 x 160 x 50	749.00
406.644	2500 x 160 x 50	978.00
406.631	3000 x 180 x 60	1,622.00
406.645	4000 x 180 x 60	2,150.00
406.646	5000 x 200 x 80	3,830.00
406.647	6000 x 200 x 80	4,600.00

DIN 874/0

Item No.	Dimensions/mm	Price EUR
406.613	1000 x 100 x 30	395.00
406.617	1500 x 100 x 30	500.00
406.621	2000 x 120 x 40	670.00
406.626	2500 x 120 x 40	933.00
406.632	3000 x 140 x 40	1,178.00
406.639	4000 x 140 x 40	1,518.00
406.618	5000 x 160 x 40	2,480.00
406.619	6000 x 160 x 40	2,940.00
With extra wide measuring faces:		
406.624	500 x 80 x 40	306.00
406.627	750 x 80 x 40	339.00
406.611	1000 x 160 x 50	479.00
406.616	1500 x 160 x 50	692.00
406.623	2000 x 160 x 50	904.00
406.628	2500 x 160 x 50	1,173.00
406.629	3000 x 180 x 60	1,929.00
406.633	4000 x 180 x 60	2,550.00
406.634	5000 x 200 x 80	4,430.00
406.635	6000 x 200 x 80	5,250.00

Cast iron straight edges with handles

Especially suitable for measuring small surfaces.

- Tension free.
- Flatness and parallelism according DIN 876.
- DIN 876/1: hand scraped,
DIN 876/0: fine scraped.
- Both measuring faces are flat and parallel
matched in pairs.



Dimensions <i>l x w/mm</i>	Weight approx./kg	DIN 876/1		DIN 876/0	
		Item No.	Price EUR	Item No.	Price EUR
500 x 35	12	403.705	191.00	403.700	258.00
750 x 50	17	403.706	303.00	403.701	393.00
1000 x 56	25	403.707	483.00	403.702	582.00
1500 x 70	65	403.708	924.00	403.703	1,177.00
2000 x 80	90	403.709	1,511.00	403.704	1,904.00

Aluminum straight edges

I-shaped straight edges with wide measuring faces. Lightweight construction and material especially promote handling of longer straight edges.

- Highly wear resistant.
- Highly corrosion resistant.
- Surface hardness: 500 - 550 HV.
- High insulation: $4 \cdot 10^{15} \Omega \text{ mm}^2/\text{m}$.
- With protective coating, thickness: 50 μm .
- Accuracy according DIN 874/1.
- Larger sizes and class 0 available on request.



Item No.	Dimensions mm	Weight kg	Tolerance μm	Price EUR
406.650	500 x 100 x 40	1.65	12	617.00
406.651	1000 x 100 x 40	3.31	21	1,136.00
406.652	1500 x 100 x 40	4.97	29	1,706.00
406.653	2000 x 100 x 40	6.62	37	2,040.00
406.654	2500 x 100 x 40	8.28	46	2,550.00
406.655	3000 x 100 x 40	9.93	54	3,060.00

Bridge-type straight edges

Made of special close-grained cast iron.

- Tension relieved.
- Flatness according DIN 876:
class 1: hand scraped,
class 0: fine scraped.



Item No.	l x w mm	Weight kg	Flatness µm	Price EUR
DIN 876/1:				
403.658	500 x 40	6	15	166.00
403.659	750 x 45	9	18	179.00
403.680	1000 x 50	17	20	321.00
403.690	1500 x 60	45	25	663.00
403.692	2000 x 70	65	30	1,018.00
403.698	3000 x 90	210	40	1,776.00
DIN 876/0:				
403.657	500 x 40	6	6	202.00
403.660	750 x 45	9	7	213.00
403.679	1000 x 50	17	8	403.00
403.691	1500 x 60	45	10	876.00
403.696	2000 x 70	65	12	1,303.00
403.697	3000 x 90	210	16	2,110.00

Triangular straight edges

On two sides scraped, triangular straight edge with screwed-in handles. The edge between the scraped sides (45° or 60°) has been accurately processed. The third side has been ground, and recessed for weight reduction at the larger types (from 500 mm).

- Tension relieved.
- Flatness of both scraped sides according DIN 876:
class 1: hand scraped,
class 0: fine scraped.



Item No.	l x w/mm	Weight/kg	Price EUR
Triangular straight edge 45°, DIN 876/1:			
403.525	250 x 50	2	129.00
403.550	500 x 75	7	273.00
403.575	750 x 90	15	421.00
403.600	1000 x 120	27	621.00
403.602	1500 x 120	48	1,053.00
Triangular straight edge 45°, DIN 876/0:			
403.524	250 x 50	2	176.00
403.549	500 x 75	7	344.00
403.574	750 x 90	15	508.00
403.599	1000 x 120	27	758.00
403.601	1500 x 120	48	1,255.00
Triangular straight edge 60°, DIN 876/1:			
403.425	250 x 45	3	138.00
403.450	500 x 60	6	255.00
403.475	750 x 90	16	397.00
403.500	1000 x 100	28	578.00
403.502	1500 x 110	50	971.00
Triangular straight edge 60°, DIN 876/0:			
403.424	250 x 45	3	171.00
403.449	500 x 60	6	326.00
403.474	750 x 80	16	486.00
403.499	1000 x 100	28	734.00
403.501	1500 x 110	50	1,244.00

Beveled straight edges

- Straightness tolerance according DIN 874/00.
- Hardened and ground.
- Lapped measuring faces.
- With insulated grip over the entire length.



Item No.	Length/mm	Price EUR
Bright steel:		
772.075	75	9.50
772.100	100	10.80
772.125	125	12.70
772.150	150	14.70
772.200	200	18.90
772.300	300	36.00
772.400	400	59.00
772.500	500	84.00

Item No.	Length/mm	Price EUR
Stainless steel:		
772.076	75	13.20
772.101	100	15.50
772.126	125	16.90
772.151	150	20.60
772.201	200	23.70
772.301	300	47.00
772.401	400	84.00
772.501	500	115.00

Beveled straight edges

- Straightness tolerance according DIN 874/00.
- Hardened and ground.
- Lapped measuring faces.
- With insulated grip over the entire length.



PRICE

Item No.	Length/mm	Price EUR
Chrome finished steel:		
907.750	75	9.10
907.751	100	10.10
907.752	125	11.30
907.753	150	15.20
907.754	200	18.90
907.755	300	28.20
907.756	400	49.00
907.765	500	71.00
909.237	600	104.00

Item No.	Length/mm	Price EUR
Stainless steel:		
907.757	75	10.00
907.758	100	11.00
907.759	125	12.90
907.760	150	16.50
907.761	200	20.60
907.762	300	33.00
907.763	400	55.00
907.764	500	79.00
909.240	600	115.00

Protractors / Clinometers / Spirit levels



Accuracy of clinometers/spirit levels according DIN 877		
Graduation $\mu\text{m/m}$	"	Flatness (μm) (L =length in mm)
≤ 50	≤ 10	$4 + L/250$
$> 50 - 200$	$> 10 - 40$	$8 + L/125$
> 200	> 40	$16 + L/60$

Universal digital bevel protractor

This digital bevel protractor displays both decimal degrees and degrees-minutes-seconds at the same time.

- Measuring range (switchable): 1x 360°,
2x 180°,
4x 90°.
- Resolution: 0.008° and 30".
- Accuracy: $\pm 0.08^\circ$ or $\pm 5'$.
- On/off switch.
- Reset/preset.
- Reversible measuring direction.
- Fine adjustment.
- Delivery in a case with three blades (150, 200 and 300 mm), a square and an acute angle attachment.
- Power supply: 1 battery type CR2032.



Item No.	Description	Price EUR
907.885	Bevel protractor	264.00
Option:		
495.157	Spare battery	0.50

Single blades

Item No.	Blade length/mm	Price EUR
909.380	150	4.30
909.381	200	6.40
909.382	300	7.50
909.383	500	15.70
909.384	600	24.40
909.385	800	41.00

Universal digital bevel protractors

Digital bevel protractors made of stainless steel, with blades of 150, 200, 300 or 500 mm. The blades and all the measuring faces are hardened.

- Measuring range (switchable): 1x 360°,
2x 180°,
4x 90°.
- Resolution: 1', or decimal 0.01°.
- Accuracy: $\pm 2'$.
- Control with 2 keys for several functions.
- Clamping spring system for blade.
- Indication switchable from degrees and minutes to decimal degrees.
- Automatic switch-off after 10 minutes of idle time with storage of the displayed measuring value.
- Opto-RS232C data output.
- Reset/preset/hold functions.
- Fine adjustment.
- Delivery in a case.
- Power supply: 1 battery type CR2032.



Complete bevel protractors

Item No.	Blade length/mm	Price EUR
856.688	150	809.00
856.689	200	819.00
856.690	300	827.00
856.691	500	869.00

Options:

495.157	Spare battery	0.50
856.694	Prism base	59.00
856.695	Ledge	47.00
781.887	Opto-RS232C cable	120.00

Single blades

Item No.	Blade length/mm	Price EUR
856.685	150	37.30
856.693	200	47.00
856.687	300	50.00
856.686	500	73.00



856.694



856.695

Universal digital bevel protractor

This stainless steel, digital bevel protractor is available with blades from 150 to 1000 mm. The blades and all the measuring faces are hardened.

- Measuring range: $\pm 360^\circ$.
- Resolution: 1', or decimal 0.01°.
- Accuracy: $\pm 2'$.
- Repeatability: 1'.
- Indication switchable from degrees and minutes to decimal degrees.
- + and - direction reversible.
- Per 90° adjustable.
- Data output, Mitutoyo Digimatic compatible.
- On/off switch.
- Reset/preset/hold functions.
- Control with 5 keys for several functions.
- Fine adjustment.
- Delivery in a case without blade.
- Power supply: 1 battery type CR2032.



Single blades

Item No.	Description	Price EUR
855.820	Bevel protractor	905.00
Options:		
495.157	Spare battery	0.50
905.409	Data cable 2 m	36.00

Item No.	Blade length/mm	Price EUR
909.380	150	4.30
909.381	200	6.40
909.382	300	7.50
909.383	500	15.70
909.384	600	24.40
909.385	800	41.00
855.827	1000	232.00

Dial bevel protractor

- Measuring range: $4 \times 90^\circ$.
- Graduation: $5'$.
- Fine adjustment.
- Hardened stainless steel construction.
- Delivery in a case with 300 mm blade and an acute angle attachment.

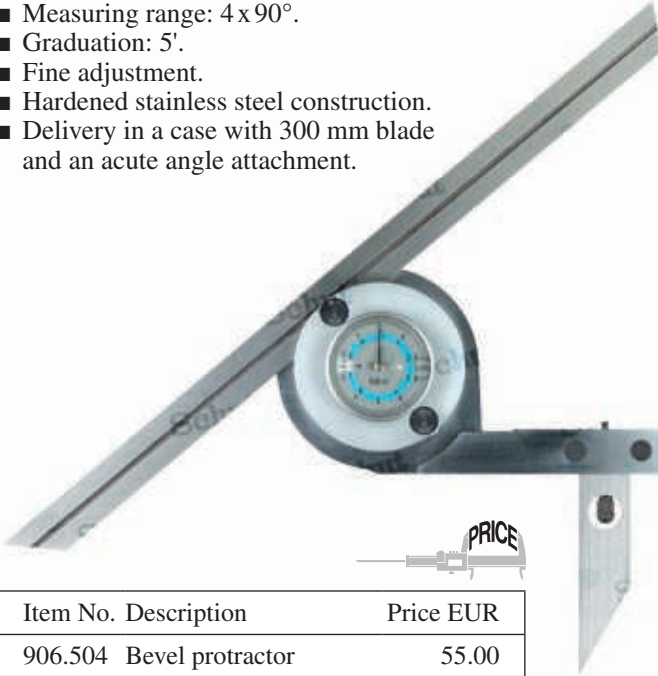

Item No.	Description	Price EUR
906.504	Bevel protractor	55.00

Single blades

Item No.	Blade length/mm	Price EUR
909.380	150	4.30
909.381	200	6.40
909.382	300	7.50
909.383	500	15.70
909.384	600	24.40
909.385	800	41.00

Bevel protractor with magnifier

- Measuring range: $4 \times 90^\circ$.
- Vernier: $5'$, parallax-free.
- Hardened stainless steel construction.

- No-glare chrome finished scale.
- Delivery in a case with 300 mm blade and an acute angle attachment.



Item No.	Description	Price EUR
906.502	Bevel protractor with magnifier	42.00
Option:		
906.505	Spare magnifier	6.00

Single blades

Item No.	Blade length/mm	Price EUR
909.380	150	4.30
909.381	200	6.40
909.382	300	7.50
909.383	500	15.70
909.384	600	24.40
909.385	800	41.00

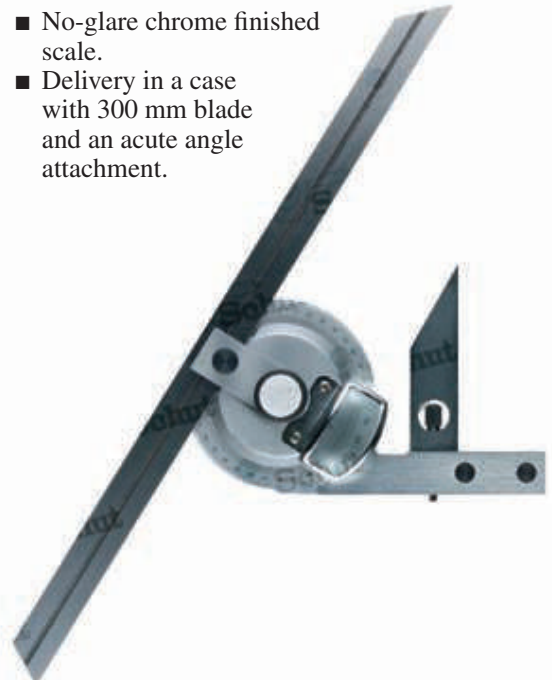

Bevel protractor with magnifier

- Measuring range: $4 \times 90^\circ$.
- Vernier: $5'$, parallax-free.
- Fine adjustment.
- Hardened stainless steel construction.
- No-glare chrome finished scale.

- Delivery in a case with two blades (150 and 300 mm) and an acute angle attachment.

Item No.	Description	Price EUR
855.801	Bevel protractor with magnifier	218.00
Option:		
859.179	Spare magnifier	37.40

Single blades

Item No.	Blade length/mm	Price EUR
909.380	150	4.30
909.381	200	6.40
909.382	300	7.50
909.383	500	15.70
909.384	600	24.40
909.385	800	41.00



Universal bevel protractor

Universal bevel protractor with micrometer screw adjustment. One rotation of the screw corresponds to an angular change of 1° . Retraction of the micrometer screw enables fast adjustment of the blade and the scale.

- Measuring range: $4 \times 90^\circ$.
- Graduation: $1'$.
- Stainless steel construction, main parts are hardened.
- Delivery in a case with two blades (150 and 300 mm) and a reference square for checking the bevel protractor.

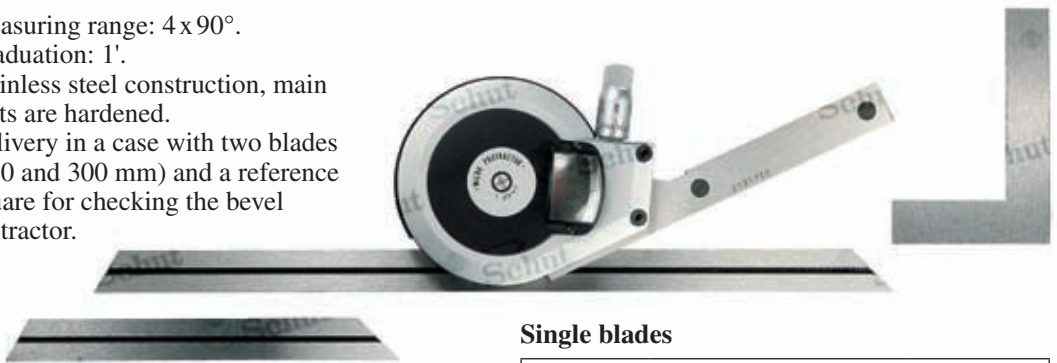

Single blades

Item No.	Description	Price EUR
855.811	Universal protractor with magnifier	574.00
Option:		
859.019	Spare magnifier	37.40

Item No.	Blade length/mm	Price EUR
909.380	150	4.30
909.381	200	6.40
909.382	300	7.50
909.383	500	15.70
909.384	600	24.40
909.385	800	41.00

Combination bevel protractor

Can be used as bevel protractor, ruler, depth gauge, try square, center square and spirit level.

- Measuring range: 0-180° (90-0-90°).
- Graduation: 1°.
- Double graduation.
- Rotatable.
- Scriber (included in square head).
- Protractor head and square head provided with a spirit level.
- Ruler length: 300 mm.
- Delivery with protractor head, square head, center head, and ruler with mm/mm graduation.



Item No.	Description	Price EUR
906.503	Combination bevel protractor	49.00

Combination bevel protractor

Combination bevel protractor with blade and flat square.

- Measuring range exterior angle: 0-180°.
- Measuring range interior angle: 40-180°.
- Vernier: 2'.
- Delivery in a case.



Item No.	Description	Price EUR
858.302	Combination bevel protractor	97.00

Bevel protractors

Simple and easy to use protractors with a semicircular or rectangular head and swivelling blade.

- Measuring range: 0-180°.
- Graduation: 1°.
- Scale diameter: 85 mm.
- Locking screw.
- Blade length: 150 mm.
- Hardened steel, no-glare chrome finished.



Item No.	Shape	Price EUR
907.863	semicircular	16.90
909.399	rectangular	16.00



Bevel protractors

- Measuring range: 0-180° (with swivelling blade) or 10-170° (with sliding blade).
- Graduation: 1°.
- Locking screw.
- Hardened steel, no-glare chrome finished.
- Graduation placed by laser.



Item No.	Scale ø/mm	Blade length/mm	Price EUR
With swivelling blade:			
907.864	80	120	13.70
907.865	120	150	16.40
907.866	150	200	18.80
907.867	200	300	25.90
907.868	300	500	50.00
With sliding blade:			
907.869	100	150	23.00
907.870	150	300	27.40
907.871	200	400	32.60
907.872	250	500	50.00
907.873	300	600	58.00



907.865



907.870

Setting bevel

- Special steel.
- Moveable blade locked with a wing nut.

NEW



910.088



Item No.	Blade length/mm	Price EUR
910.088	200	11.80
910.089	300	16.30
910.090	500	20.50

Universal digital bevel protractor with spirit level

Digital bevel protractor for measuring both inside and outside angles. The measuring value is displayed upright at any time. Equipped with four holes and a locking knob for measuring a specific angle.

- Measuring range: 360°.
- Resolution: 0.05°.
- Accuracy: $\pm 0.2^\circ$.
- ABS/INC switchable.
- With digital-analog display of the measured value.
- Reversal of display value.
- On/off switch.
- Hold function.
- Reversible measuring direction.
- Aluminum casing.
- Rotatable blade of metal.
- Dimensions: 254 x 50 x 36 mm.
- Power supply: 1 battery type CR2032.



Item No.	Description	Price EUR
909.503	Bevel protractor	54.00
Option:		
495.157	Spare battery	0.50



Universal digital bevel protractors

Digital bevel protractors for measuring both inside and outside angles. Equipped with a locking knob for measuring a specific angle.

- Measuring range: $\pm 360^\circ$.
- Resolution: 0.1° .
- Accuracy: $\pm 0.3^\circ$.
- On/off switch.
- Automatic switch-off.
- Zero setting at any position.
- Graduation rulers: 1 mm and 1/32 inch.
- Cross-section rulers: 35 x 2.5 mm.
- With fixing holes.
- Locking screw.
- Power supply: 1 battery type CR2032.



Item No.	Ruler length/mm	Price EUR
909.505	200	29.70
909.506	300	38.60
909.507	500	48.00
Option:		
495.157	Spare battery	0.50

Magnetic clinometers with center point finder

Accurate clinometers with an extremely sensitive, balanced needle. The magnetic base with 90° V-groove is precision milled. The center point finder can be used as a center punch.

Very suitable for angular measurements, surface alignment, and the determination of center points and highest/lowest points of cylindrical and spherical surfaces. Therefore ideal as a universal aid to the installation of larger constructions.

- Measuring range: 360° .
- Graduation: 1° .
- Scale numbering: 0-360 clockwise (CW) or counterclockwise (CCW), or 0-90-0.
- Aperture V-groove (horizontal): 82 mm (for shafts up to $\varnothing 115$ mm).
- Dimensions $h \times w \times d$: 130 x 130 x 27 mm.

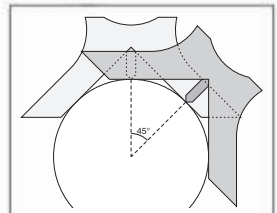

For marking angles on cylindrical and spherical surfaces.



Item No.	Scale numbering	Price EUR
856.702	0-360 CCW	264.00
856.703	0-360 CW	264.00
856.704	0-90-0	264.00
Options:		
856.705	Wooden case	27.50
856.706	Suction magnifier glass	28.10

Digital clinometers

- Measuring range: $\pm 180^\circ$
(with external sensor: $\pm 360^\circ$).
- Resolution: 0.1° .
- Accuracy 0- 10° : $\pm 0.1^\circ$,
10- 170° : $\pm 0.2^\circ$,
170- 180° : $\pm 0.1^\circ$.
- Repeatability: 0.1° .
- ABS/INC switchable (except 906.476).
- Automatic switch-off.
- Hold function (only 906.479).
- With magnetic base (906.476/479)
or magnetic upper part (909.501/502).
- Dimensions: 51 x 51 x 33 mm.
- Power supply: 1 battery type CR2032.

Models with external sensor

- Accuracy 0- 10° : $\pm 0.1^\circ$,
10- 350° : $\pm 0.2^\circ$,
350- 360° : $\pm 0.1^\circ$.
- Sensor with mounting holes.
- Cable length: 1 m.
- Max. rotation speed: 600 rpm.



906.476



906.479



909.501



909.502



Item No.	Description	Price EUR
906.476	Standard model	44.00
906.479	With vial	56.00
909.501	With external sensor	78.00
909.502	With external sensor with axis $\varnothing 6$ mm	78.00
Option:		
495.157	Spare battery	0.50



Digital clinometers

Instruments for easy measurement of angles, flatness and squareness. All four sides are measuring faces. The measuring value is displayed upright at any time.

- Measuring range: 4 x 90°.
- Resolution: 0.1°.
- Accuracy 0-10°: ±0.1°,
10-80°: ±0.2°,
80-90°: ±0.1°.
- Repeatability: 0.1°.
- ABS/INC switchable.
- Large, easy-to-read LCD display.
- Hold function.
- Width measuring faces: 6 mm.
- Delivery in a case.

908.926

- Measuring face bottom-side: 2 tapped holes M4, center distance 130 mm.
- Dimensions *l x w x h*: 150 x 33 x 52 mm.
- Power supply: 1 battery type CR2032.

909.504

- Blue backlight.
- Sound signal at stable value.
- °, mm/m, %, inch/ft conversion.
- Reference plane function.
- Measuring faces bottom- and upper-side with V-groove.
- With magnetic base.
- Protection: IP65.
- Dimensions *l x w x h*: 150 x 33 x 60 mm.
- Power supply: 2 batteries type AAA.



908.926



909.504



909.504



Item No.	Description	Price EUR
908.926	With tapped holes	60.00
909.504	With V-grooves and magnetic base	74.00
Options:		
495.157	Spare battery	0.50
497.914	Spare battery (2 needed)	0.40

Digital clinometers

Instruments for easy measurement of inclination. Equipped with a horizontal and vertical vial. The measuring value is displayed upright at any time.

- Measuring range: 4 x 90°.
- Resolution: 0.1°.
- Accuracy 0-10°: ±0.1°,
10-80°: ±0.2°,
80-90°: ±0.1°.
- °/% conversion.
- Large, easy-to-read LCD display.
- On/off switch.
- Hold function.
- Sound signal at: 0°, 45°, 90°.
- Laser spot (only 906.478).
- Measuring face on the bottom-side.
- Length: 600 mm.
- Delivery in a case.
- Power supply: 2 batteries type AAA.

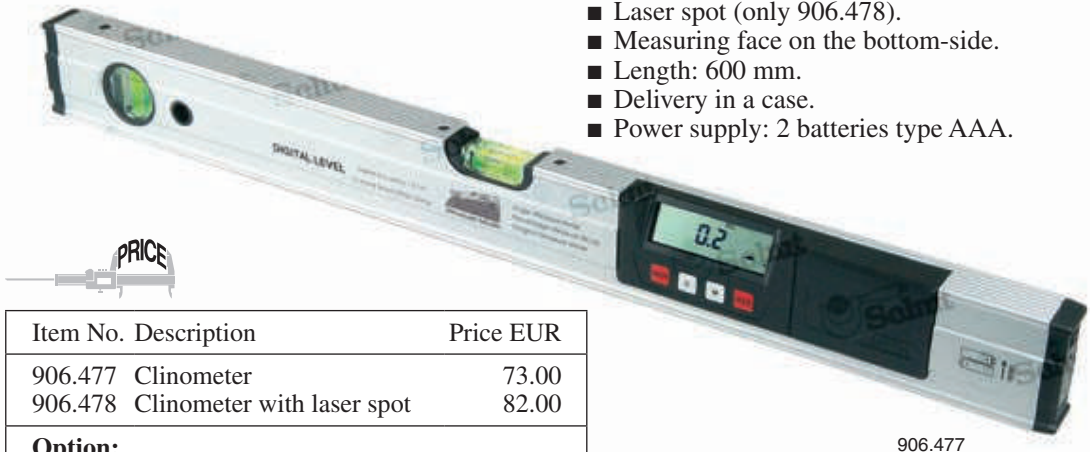

906.477

Item No.	Description	Price EUR
906.477	Clinometer	73.00
906.478	Clinometer with laser spot	82.00
Option:		
497.914	Spare battery (2 needed)	0.40

Laser alignment tool

With this alignment tool you can exactly, quickly and easily project vertical, horizontal and crossed laserlines. Within a range of ±4° minor inclination errors are automatically compensated by means of the integrated spirit level, to level the projected horizontal line.

- Range: up to 5 m (dependent on the lighting conditions).
- Self-levelling range: 4°.
- Horizontal and vertical accuracy: ±2 mm/m.
- Laser: 650 nm, class 2 conform to IEC 60825-1.
- Lock function for projecting at an angle and transport protection.
- Mounted on rotatable base.
- On/off switch.
- Diameter: ø 120 mm.
- Height: 170 mm.
- Weight: 420 g.
- Delivery in a case incl tripod.
- Power supply: 2 batteries type AA.

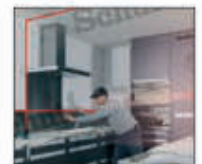



Item No.	Description	Price EUR
909.499	Alignment tool	70.00
Option:		
495.111	Spare battery (2 needed)	0.40

TESA Clinobevel 1-USB digital clinometer

The TESA Clinobevel 1-USB is a compact and universal clinometer with four measuring faces and a reinforced aluminum housing, resistant to workshop conditions. For a higher accuracy 21 correction values can be stored. The software can perform calculations with two instruments and export automatic reports. A remote control device is optionally available, to take measurements without making contact with the Clinobevel or the measuring surface.

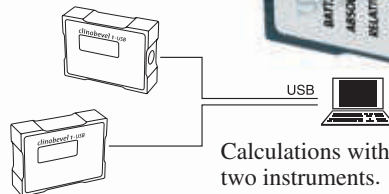
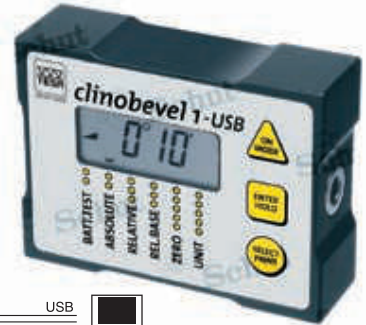
- Measuring range: $\pm 45^\circ$.
- Resolution: 0.02 mm/m.
- Accuracy: 2' + 1 sd.
- USB data output.
- Read-out after approx. 1 s when idle.
- Dimensions: 100 x 75 x 35 mm.
- Protection: IP65.
- DIN 2276 T2.
- Delivery in a case with batteries, USB cable (1.8 m), software, user manual, inspection report and declaration of conformity.
- Power supply: 4 batteries type AA.



Read-out angles:

- degrees (2 or 4 decimals)
- degrees and minutes

Read-out inclination:

- mm/m (2 decimals)
- inch/10 inch or inch/12 inch (4 decimals)
- mm or inch/basis length (comparative mode)
- milliradians (whole or 2 decimals)
- gon (2 decimals)

Item No.	Type/description	Price EUR
781.545	Clinobevel 1-USB	
Options:		
495.111	Spare battery (4 needed)	
779.050	Clinobevel Zapper remote control	

TESA Niveltronic electronic levels

Cast iron housing with built-in analog indicator, on/off switch, battery check and adjustable sensitivity, and a potentiometer for the reset position.

- Measuring range I: ± 0.75 mm/m,
II: ± 0.15 mm/m.
- Graduation I: 0.05 mm/m,
II: 0.01 mm/m.
- Accuracy:
 ± 0.005 mm/m + 1% of the measured value.
- Repeatability: 0.001 mm/m.
- Analog output:
 ± 0.2 V.
Impedance:
4.5 k Ω .
- DIN 2276 T2.
- Delivery in a case with a declaration of conformity.
- Power supply:
4 batteries type AAA.



Item No.	Type/description	Base length mm	Price EUR
781.557	Horizontal model	150	
781.558	Angled model	200	
Options:			
497.914	Spare battery (4 needed)		
781.559	Granite base	200	
781.560	Granite base	250	
781.561	Granite base	500	

Clinometers

- Measuring range: 4 x 90°.
- Graduation: 1°.
- Dimensions: 100 x 15 x 100 mm.



857.302

Item No.	Description	Price EUR
857.302	Clinometer with removable base 100 mm	162.00
857.304	Base 200 mm	33.10
857.305	Base 300 mm	36.60
857.306	Base 500 mm	45.00
857.307	Base 1000 mm	68.00
857.303	Clinometer with magnetic base 100 mm	215.00

Vernier clinometers

Clinometers with two ground bases with V-groove, or two flat magnetic bases. Vial holder with vernier and fine adjustment.

- Measuring range: 0 - 90°.
- Vernier: 10'.
- Graduation vial: 0.3 mm/m \cong 1'.
- Dimensions: 150 x 39 x 150 mm.

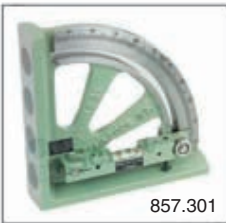

857.301



857.300

Item No.	Description	Price EUR
857.300	Bases with V-groove	499.00
857.301	Flat magnetic bases	682.00

Clinometer

- Measuring range: 4 x 90°.
- Graduation: 1°.
- Graduation vial: 2 - 5 mm/m.
- Flat base: 300 x 25 mm.
- With mounting holes.



Item No.	Description	Price EUR
853.669	Clinometer	240.00

Clinometer

To determine inclinations accurately. Fine-tuning by means of a screw thread spindle, which, to ensure a quick tuning, can be disconnected by pressing the button on the micrometer.

- Measuring range: $\pm 180^\circ$.
- Read-out in degrees and minutes.
- Scale numbering black clockwise, red counterclockwise.
- Graduation vial: 0.3 mm/m \cong 1'.
- Hardened and ground base, with V-groove.
- Base dimensions: 150 x 30 mm.
- Height: 124 mm.



Item No.	Description	Price EUR
857.310	Clinometer	1,234.00

Inspection spirit levels

- Graduation main vial: 0.01 - 0.3 mm/m.
- With cross test vial.
- Base with V-groove.
- Base width: 42 mm
(spirit levels with length 500 mm: 44 mm).
- DIN 877.
- Delivery in a luxurious case.

Item No.	Length mm	Graduation mm/m	Price EUR
853.601	160	0.3	135.00
853.606	160	0.1	145.00
853.611	160	0.04	199.00
853.616	160	0.02	239.00
853.602	200	0.3	155.00
853.607	200	0.1	172.00
853.612	200	0.04	232.00
853.617	200	0.02	283.00
853.621	200	0.01	352.00
853.603	250	0.3	175.00
853.608	250	0.1	187.00
853.613	250	0.04	271.00
853.618	250	0.02	312.00
853.622	250	0.01	379.00
853.604	300	0.3	188.00
853.609	300	0.1	208.00
853.614	300	0.04	298.00
853.619	300	0.02	335.00
853.623	300	0.01	427.00
853.605	500	0.3	382.00
853.610	500	0.1	410.00
853.615	500	0.04	511.00
853.620	500	0.02	567.00
853.624	500	0.01	653.00

Inspection spirit levels

- Graduation main vial: 0.02 - 0.5 mm/m.
- Adjustable main vial.
- With cross test vial.
- Base with V-groove, interrupted at the center over 1/3 of the length.
- Base width: 40 mm.
- DIN 877.
- Delivery in a luxurious case.

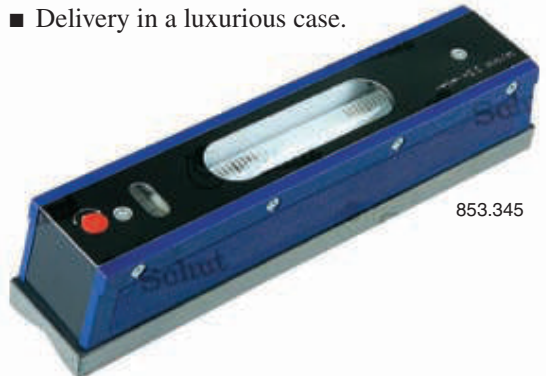

853.345

Item No.	Length mm	Graduation mm/m	Price EUR
853.343	150	0.5	156.00
853.341	150	0.1	166.00
853.315	150	0.05	172.00
853.348	150	0.02	186.00
853.345	200	0.5	170.00
853.344	200	0.1	183.00
853.323	200	0.05	189.00
853.322	200	0.02	221.00
853.347	300	0.5	197.00
853.346	300	0.1	212.00
853.324	300	0.05	224.00
853.325	300	0.02	258.00

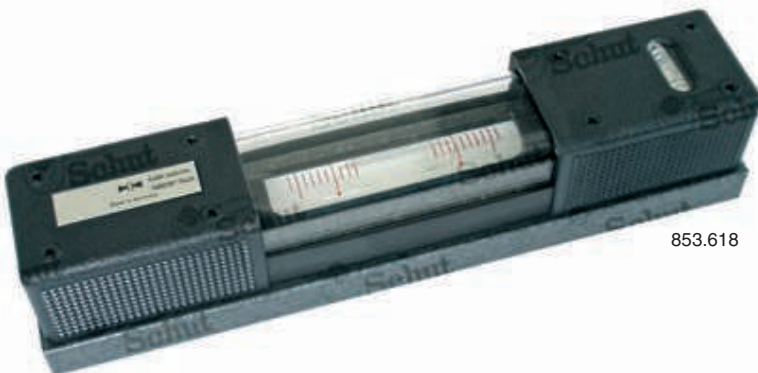

853.618



Inspection spirit levels

- Graduation main vial: 0.05 or 0.02 mm/m.
- Adjustable main vial.
- With cross test vial.
- Base with V-groove.
- Base width: 46 mm.
- Robust cast iron construction.
- With insulating grip.
- DIN 877.



908.685



Item No.	Length mm	Graduation mm/m	Price EUR
908.688	150	0.05	62.00
908.684	150	0.02	62.00
908.689	200	0.05	66.00
908.685	200	0.02	66.00
908.690	250	0.05	93.00
908.686	250	0.02	93.00
908.691	300	0.05	109.00
908.687	300	0.02	109.00



Frame spirit levels

- Graduation main vial: 0.05 or 0.02 mm/m.
- Adjustable main vial.
- With cross test vial.
- Two faces with V-groove, two flat faces.
- Robust cast iron construction.
- With insulating grip.
- DIN 877.



908.693



Item No.	Dimensions mm	Graduation mm/m	Price EUR
908.696	150 x 150 x 40	0.05	71.00
908.692	150 x 150 x 40	0.02	71.00
908.697	200 x 200 x 40	0.05	76.00
908.693	200 x 200 x 40	0.02	76.00
908.698	250 x 250 x 40	0.05	109.00
908.694	250 x 250 x 40	0.02	109.00
908.699	300 x 300 x 40	0.05	134.00
908.695	300 x 300 x 40	0.02	134.00

Frame spirit levels

- Graduation main vial: 0.01 - 0.3 mm/m.
- With cross test vial.
- Three faces with V-groove, one flat face.
- DIN 877.
- Delivery in a luxurious case.



853.638

Item No.	Dimensions mm	Graduation mm/m	Price EUR
853.625	100 x 100 x 34	0.3	224.00
853.629	100 x 100 x 34	0.1	274.00
853.633	100 x 100 x 34	0.04	343.00
853.626	150 x 150 x 42	0.3	267.00
853.630	150 x 150 x 42	0.1	312.00
853.634	150 x 150 x 42	0.04	418.00
853.637	150 x 150 x 42	0.02	459.00
853.627	200 x 200 x 42	0.3	318.00
853.631	200 x 200 x 42	0.1	383.00
853.635	200 x 200 x 42	0.04	500.00
853.638	200 x 200 x 42	0.02	557.00
853.640	200 x 200 x 42	0.01	814.00
853.628	300 x 300 x 44	0.3	528.00
853.632	300 x 300 x 44	0.1	651.00
853.636	300 x 300 x 44	0.04	766.00
853.639	300 x 300 x 44	0.02	797.00
853.641	300 x 300 x 44	0.01	1,058.00

Frame spirit levels

- Graduation main vial: 0.02 - 0.5 mm/m.
- Adjustable main vial.
- With cross test vial.
- Three faces with V-groove, interrupted at the center over $\frac{1}{3}$ of the length. One flat face.
- DIN 877.
- Delivery in a luxurious case.

Item No.	Dimensions mm	Graduation mm/m	Price EUR
853.372	150 x 150 x 40	0.5	230.00
853.371	150 x 150 x 40	0.1	263.00
853.375	150 x 150 x 40	0.05	304.00
853.376	150 x 150 x 40	0.02	348.00
853.374	200 x 200 x 40	0.5	269.00
853.373	200 x 200 x 40	0.1	292.00
853.385	200 x 200 x 40	0.05	349.00
853.382	200 x 200 x 40	0.02	385.00
853.395	250 x 250 x 40	0.05	413.00
853.392	250 x 250 x 40	0.02	426.00



853.376



Crankshaft spirit levels

- Graduation main vial: 0.04 - 0.6 mm/m.
- With cross test vial.
- Base with a longitudinal and a lateral V-groove.



- Base width: 42 mm.
- DIN 877.

Item No.	Length mm	Graduation mm/m	Price EUR
853.684	60	0.6	151.00
853.687	60	0.2	170.00
853.682	90	0.3	164.00
853.685	90	0.1	181.00
853.688	90	0.04	220.00
853.683	120	0.3	182.00
853.686	120	0.1	202.00
853.689	120	0.04	250.00

Aluminum spirit levels

- Graduation vial: 0.6 mm/m.
- Base with V-groove.
- Base width: 22 mm.
- DIN 877.



Item No.	Length/mm	Price EUR
853.675	100	43.00
853.676	150	48.00
853.677	200	54.00
853.678	250	67.00
853.679	300	78.00

Small spirit levels

Intended for simple tasks.

- Graduation vial: 0.1 or 0.3 mm/m.
- With longitudinal spirit level.
- Width: 24 mm.

- Equipped with mounting holes $\varnothing 5$ mm.
- Flat base.
- DIN 877.

Item No.	Length mm	Graduation mm/m	Price EUR
853.665	100	0.3	111.00
853.666	100	0.1	119.00
853.667	150	0.3	116.00
853.668	150	0.1	127.00



Crankpin levels

Crankpin levels with two vials, in cast iron casing
80 x 80 mm, cross-section 20 x 20 mm, with two
screw holes \varnothing 4 mm.

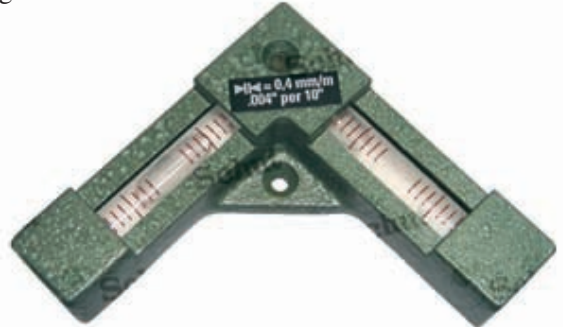

857.338

Item No.	Graduation mm/m	Price EUR
857.338	0.4	229.00
857.339	0.1	259.00
857.340	0.05	331.00



857.342

Crankpin levels with two vials, in circular chrome casing
with three screw holes \varnothing 2.5 or \varnothing 4 mm.

Item No.	Graduation mm/m	Dimensions mm	Screw holes \varnothing /mm	Price EUR
857.341	1	\varnothing 40 x 11	2.5	127.00
857.342	0.4	\varnothing 80 x 23	4	189.00
857.343	0.1	\varnothing 80 x 23	4	199.00

Spirit levels with flat base

Spirit levels with a stainless steel strip base, no
screw mounting, with an adjustable plexiglass vial
mounted onto it, graduation approx. 5 mm/m.

Item No.	Dimensions base <i>l</i> x <i>w</i> x <i>t</i> /mm	Price EUR
857.344	100 x 20 x 5	85.00
857.345	150 x 20 x 5	100.00
857.346	200 x 20 x 5	127.00



857.344

Spirit levels with a stainless steel strip base, no screw
mounting, with two ground contact planes. Mounted
onto this an adjustable spirit level with cast iron housing,
graduation 1 mm/m.

Item No.	Dimensions base <i>l</i> x <i>w</i> x <i>t</i> /mm	Price EUR
857.347	100 x 20 x 5	49.00
857.348	150 x 20 x 5	56.00
857.349	200 x 20 x 5	60.00



857.347

Circular spirit levels

Item No.	Diameter mm	Height mm	Sensitivity* mm/m	Price EUR
Plexiglass model with yellow and green base:				
857.315	12	7	approx. 22	5.20
857.316	15	8	approx. 22	6.20
857.317	18	9	approx. 22	7.30
857.318	30	10	approx. 22	9.40
Black synthetic model with frame and screw holes $\varnothing 2.5$ mm and yellow and green base:				
857.320	26/17	7 +3	approx. 19	9.40
857.321	30/20	7.5+3.5	approx. 19	10.40
Chrome casing and white base:				
857.323	15	10	approx. 8	35.00
857.324	18	10	approx. 8	35.00
Chrome casing with frame and screw holes $\varnothing 2.5$ mm (857.325: $\varnothing 1.5$ mm; 857.330/331: $\varnothing 3.5$ mm) and white base:				
857.325	20/13.5	7 +2	approx. 8	26.70
857.326	25/17	7.5+2.5	approx. 8	29.10
857.327	30/17	6.5+3.5	approx. 8	31.50
857.328	35/20	7.5+3.5	approx. 6	44.00
857.329	40/25	8 +4	approx. 6	61.00
857.330	50/34	9.5+5.5	approx. 3	82.00
857.331	60/39	10 +7	approx. 3	112.00
857.332	25/17	7.5+2.5	approx. 2	26.80
White, synthetic casing with frame and screw holes $\varnothing 3$ mm, additional scale circles and white base:				
857.336	60/45	4+6	Reading $0^{\circ} - 2^{\circ} - 5^{\circ}$	76.00
Black, synthetic casing with frame and screw holes $\varnothing 5$ mm, additional scale circles and white base:				
857.337	100/75	5+10	Reading $0^{\circ} - 3^{\circ} - 6^{\circ}$	88.00

* Sensitivity means: the angle at which the air bubble is moved to the next scale mark or edge of the vial.



857.318



857.320



857.323



857.331



857.336



857.337



Surface roughness testers / Roughness specimens



Taylor Hobson Surtronic Duo surface roughness tester

The Surtronic Duo roughness tester is portable and easy to use with one click measurement of the five most used roughness parameters. The large 2.4" LCD colour screen also displays results in a graph for easy visual identification of surface defects. The robust rubberized housing and powerful Li-Poly battery make the Surtronic ideal for portability and shop floor environment. The Surtronic Duo can be split into a separate display and sensor unit using Bluetooth for wireless communication between the two units.

- Remote operation with display unit via Bluetooth.
- Simple calibration with the supplied calibration standard.
- User-friendly, with a 2.4" clear LCD color display.
- With 5 parameters: Ra, Rz, Rv, Rp, Rt.
- Measuring range:
Ra: 0.1 - 40 μm ,
Rz, Rv, Rp, Rt: 0.1 - 199 μm .
- Resolution: 0.01 μm .
- Traverse length: 5 mm.
- Accuracy: 0.1 μm or $\pm 5\%$ of the measuring value.
- mm/inch conversion.
- Measuring force: 2 mN.
- Cut-off lengths: 0.8 mm.
- Diamond stylus tip: radius 5 μm .
- Probe measuring range (piezoelectric): 200 μm .
- Filter: Gaussian.
- Dimensions:
Display unit: 100 x 54 mm.
Sensor unit: 92 x 35 x 45 mm.
Compound instrument: 105 x 54 x 70 mm.
- Weight: 400 g.
- Delivery in a case incl. calibration standard and charger.
- Power supply: rechargeable Li-Poly battery (included).

NEW



Item No.	Type	Price EUR
371.003	Surtronic Duo	

Mitutoyo Surftest SJ-210 surface roughness tester

The portable Mitutoyo Surftest SJ-210 is a compact tester of surface roughness parameters, that can also function in hard-to-reach places because of the separable drive unit and probe. The diamond stylus has a radius of 2 μm and is retracted by the drive unit. After selection of the desired parameters, they can be read out clearly on the display. The SJ-210 has a USB, an RS232C and a Digimatic data output to which the Mitutoyo u-wave system can be connected for wireless data transfer. The data can also be stored on a micro-SD card. A large selection of probes and accessories is available.

An S-Drive unit is available on request, with a transverse tracing drive unit, for example for measuring in narrow spaces like crankshafts. Also available on request is the Front Lift model, where the drive lifts the diamond stylus at the end of the measurement and is retracted without touching the surface again.

- Parameters: Ra, Rc, Ry, Rz, Rq, Rt, Rmax, Rp, Rv, R3z, Rsk, Rku, Rc, R_{Pc}, R_{sm}, Rz1max, S, HSC, RzJIS, R_{ppi}, R Δ a, R Δ q, R_{lr}, R_{mr}, R_{mr(c)}, R δ c, Rk, R_{pk}, R_{vk}, Mr1, Mr2, A1, A2, Vo, R_{pm}, tp, H_{tp}, R, Rx, AR.
- Resolution: 0.02 μm , 0.006 μm or 0.002 μm .
- Traverse length: 0.3 - 17.5 mm.
- Primary profile, roughness (R), DF profile, R-Motif.
- Measuring accuracy according JIS, ISO, VDA, ANSI.
- 2.4" TFT color display.
- Display of: roughness profile and ADC/BAC curves.
- User rights protection (password protection).
- Easy calibration procedure.
- Automatic switch-off.
- Memory: 10 settings and 1 profile.
- Go/NoGo tolerance evaluation.
- Measuring speed: 0.25, 0.5 or 0.75 mm/s.
- Probe: 0.75 mN/2 $\mu\text{m}/60^\circ$.
- Cut-off lengths: 0.08 mm, 0.25 mm, 0.8 mm and 2.5 mm.
- Probe measuring range: 360 μm .
- Filters: 2CR75, Gaussian and PC75.
- Dimensions: 160 x 65.8 x 52.1 mm.
- Weight: display unit: 290 g,
drive unit: 190 g.
- ISO 4287.
- Power supply: AC adapter and battery.
- After use the probe can be retracted to prevent the diamond stylus tip from being damaged.
- Memory card: micro-SD 2 GB (optional).
Storage for 10 000 measured profiles.
- Also probes available for example for deep grooves or small holes.
- USB and RS232C cables available.
- USB data analysis software can be downloaded for free.



S-Drive unit

Item No.	Type/description	Price EUR
178.560	Surftest SJ-210P	
Options:		
120.210	Extension 50 mm	
120.221	Adapter for stand (\varnothing 8 mm)	
178.421	Thermal printer	
270.732	Printing paper (5 rolls)	

Standard accessories:

- standard probe,
- extension cable for the probe unit for measuring in small spaces,
- roughness specimen,
- setting piece for calibration,
- AC adapter,
- handy carrying case.



Mitutoyo Surftest SJ-310 surface roughness tester

The Mitutoyo Surftest SJ-310 is a compact, portable roughness tester with the possibility to print on location the measuring results and roughness curves with the built-in thermo printer. Measurements can be set using the 5.7" color touch screen and measurements can be read. Measurements can be stored on a SD memory card. On request, as for the SJ-210, an S-Drive or Front Lift model is available.

- Parameters: Ra, Rc, Ry, Rz, Rt, Rp, Rq, Rv, Sm, Rmax, S, Pc, R3z, Rsk, Rku, Rz1max, Rir, Rpm, mr (c), Rpk, Rvk, δc , Rk, Mr1, Mr2, Lo, Ppi, R, AR, Rx, A1, A2, Vo, HSC, Rmr, SK, Tp, Htp, Δa , Δq , Wte, Wx, W, AW, λa , λq , RzJIS.
- Resolution: 0.002 μm - 0.02 μm .
- Traverse length: 16 mm.
- Measuring accuracy according ISO, VDA, ANSI and JIS.
- Cut-off lengths: 0.08 mm, 0.25 mm, 0.8 mm, 2.5 mm and 8 mm.
- Probe measuring range: 360 μm .
- Built-in printer for statistical process control.
- ISO 4287.
- Power supply: AC adapter and battery.



Standard accessories:

- standard probe,
- roughness specimen,
- support feet,
- nosepiece for flat surface,
- nosepiece for cylinder,
- extension cable for the probe unit,
- touch pen,
- touch panel protection foil,
- printer paper (5 rolls),
- setting piece for calibration,
- AC adapter and battery,
- carrying case.

Ask for
the detailed
brochure

Item No.	Type	Price EUR
178.570	Surftest SJ-310	

Mitutoyo Surftest SJ-410 surface roughness testers

The Mitutoyo Surftest SJ-410 is unique by skidless measuring. Only the stylus follows the product and no skid is used. The probe features a measuring range of 800 μm . The built-in straight guide enables measuring the primary profile, the roughness profile and the waves. By surface radius compensation it is possible to measure radially on a cylinder.

- Parameters: Ra, Rc, Ry, Rz, Rt, Rp, Rq, Rv, Sm, Rmax, S, Pc, R3z, Rsk, Rku, Rz1max, Rir, Rpm, mr (c), Rpk, Rvk, δc , Rk, Mr1, Mr2, Lo, Ppi, R, AR, Rx, A1, A2, Vo, HSC, Rmr, SK, Tp, Htp, Δa , Δq , Wte, Wx, W, AW, λa , λq , RzJIS.
- Resolution: 0.0001 μm - 0.01 μm .
- Measuring accuracy according ISO, VDA, ANSI and JIS.
- Cut-off lengths: 0.08 mm, 0.25 mm, 0.8 mm, 2.5 mm and 8 mm.
- Probe measuring range: 800 μm .
- Straightness x-axis: SJ-411: 0.3 $\mu\text{m}/25$ mm, SJ-412: 0.5 $\mu\text{m}/50$ mm.
- Built-in printer for statistical process control.
- ISO 4287.
- Power supply: AC adapter and battery.

Ask for
the detailed
brochure



Item No.	Type	Traverse length/mm	Price EUR
178.580	Surftest SJ-411	25	
178.582	Surftest SJ-412	50	

TESA Rugosurf 10G/20 surface roughness testers

Robust, versatile and compact roughness tester, designed for inspecting any workpiece surface finish and capturing roughness parameter values. Possible tolerancing of each parameter available. Interchangeable probe, swivelling through to 90° to let you measure even in hard-to-reach recesses. A large selection of probes and accessories is available.

The Rugosurf has an USB data output and a rechargeable battery, and is provided with a graphic color display (10G) for optimum visual representation of the measured parameters and workpiece profiles. Fast and easy analysis of the results obtained from the measured parameters with assigned tolerances.

- Parameters: Ra, Rq (RMS), Rt, Rz, Rc, Rsm, Pt, Pmr and Rmr according ISO 4287; R, Rx and AR according ISO 12085 (CNOMO). Rmax according DIN 4768.
- Resolution: 0.001 μm .
- Traverse length: 0.25 - 16 mm.
- USB data output.
- Automatic switch-off.
- Memory for last 999 (10G) measuring values.
- Storage for 20 measurements with additional graphics or 1000 measurements with roughness parameters (only Rugosurf 20).
- Go/NoGo tolerance evaluation.
- Max. measuring force: 0.75 mN (ISO 3274).
- Cut-off lengths: 0.25 mm, 0.8 mm and 2.5 mm.
- Diamond stylus tip: radius 5 μm .
- Probe measuring range: 300 μm (10G), 400 μm (20).
- Filter: Gaussian according ISO 11562.
- Dimensions: 10G: 122 x 53 x 75 mm, 20 : 122 x 60 x 62 mm.
- Weight: 590 g (10G), 650 g (20).
- Power supply: AC adapter, and rechargeable battery 7.2 V.



Standard accessories:

- standard probe (type SB 10),
- roughness specimen ($R_a = 2.97 \mu\text{m}$),
- adapter 8 mm for stands,
- positioning support,
- rechargeable battery,
- battery charger,
- user manual with a declaration of conformity,
- case.

Item No.	Type	Price EUR
782.584	TESA Rugosurf 10G	
783.499	TESA Rugosurf 20	
Options:		
783.282	USB cable for Rugosurf 20	
783.283	USB cable for Rugosurf 10G	
782.847	Rugosoft software	

Roughness specimens

Series of roughness specimens, type Microsurf, covering the nine most frequently occurring manufacturing operations; per set eight specimens will be delivered. In addition to the roughness value R_a in μm , the roughness value CLA in μin and the N values are specified.



Item No.	Machining-method	Number of specimens per set	Roughness R_a μm	Roughness CLA μin	Roughness class N	Price EUR
850.315	Surface grinding	8	0.025- 3.2	1- 125	1- 8	102.00
850.316	Cylindr. grinding	8	0.025- 3.2	1- 125	1- 8	102.00
850.319	Face turning	8	0.4 - 50	16-2000	5-12	102.00
850.320	Turning	8	0.4 - 50	16-2000	5-12	102.00
850.321	End milling	8	0.4 - 50	16-2000	5-12	102.00
850.322	Reaming & drilling	8	0.4 - 12.5	16- 500	5-10	102.00
850.323	Horizontal milling	8	0.4 - 50	16-2000	5-12	102.00
850.325	Planing	8	0.8 -100	32-4000	6-13	102.00
850.331	Spark erosion	8	0.4 - 50	16-2000	5-12	102.00

Available with declaration of conformity on request.

Wall chart

Eight Microsurf roughness specimens, mounted on a general reference chart, can be obtained for the following manufacturing operations:

- Surface grinding, cylindrical grinding, face turning, turning, end milling, reaming & drilling, horizontal milling and planing.
- Dimensions $w \times h$: 740 x 310 mm.

Item No.	Description	Price EUR
850.314	Microsurf	714.00



Roughness specimens in a set



850.130

This set consists of 30 specimens, mounted in an attractive wallet with instruction card. In addition to the R_a values, the standardized N values and the R_z values are specified.



Set composition

Item No.	Language	Price EUR
850.130	English	182.00
850.131	French	182.00
850.132	German	182.00

On request available with a declaration of conformity.

Number of specimens	Machining method	Roughness $R_a/\mu\text{m}$	Roughness class N
3	Flat lapping	0.05 - 0.2	2, 3, 4
3	Reaming	0.4 - 1.6	5, 6, 7
6	Grinding	0.05 - 1.6	2, 3, 4, 5, 6, 7
6	Horizontal milling	0.4 - 12.5	5, 6, 7, 8, 9, 10
6	Vertical milling	0.4 - 12.5	5, 6, 7, 8, 9, 10
6	Turning	0.4 - 12.5	5, 6, 7, 8, 9, 10

Roughness specimens for blasted surfaces

- Each plate consists of four roughness specimens for grit and shot blasting, in 4 segments.
- Delivery in a solid, leather wallet.
- Standardized to ISO specifications.



Item No.	Description	Price EUR
850.017	Shot blasting	133.00
850.018	Grit blasting	133.00

Gauge blocks / Measuring balls / Step gauges
Optical flats and parallel optical flats / Feeler gauges

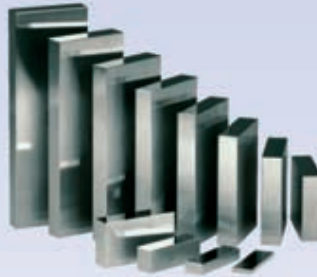
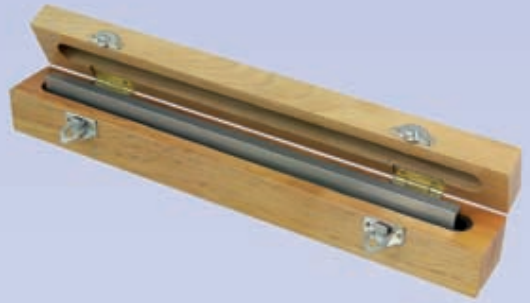

Gauge blocks general

Which gauge block is the most suitable for you?

MATERIALS

Steel

Steel is the oldest material and remains the most commonly accepted for gauge blocks. If well taken care of, steel gauges guarantee many years of useful life. They must be cleaned carefully before and after use and stored in a protective case in a dry environment.

Tungsten carbide

When a higher degree of hardness is needed, tungsten carbide is the material to choose. It is less sensitive to wear and damage compared to hardened steel. Especially when used frequently, tungsten carbide has an increased life span compared to steel gauge blocks.

Ceramics

Ceramics is relatively wear resistant and has a high degree of strength and stability. It will not rust and is unaffected by chemicals.



ACCURACY CLASSES

Gauge blocks are classified in upgrading order of accuracy according EN ISO 3650: 1998 in the classes: 2–1–0–K. The ISO 3650 is an international standard, which is adopted by national standards such as RvA, DAkkS, UKAS, BKO, SCS and COFRAC.

Class 2

Class 2 gauge blocks are intended for general workshop use by skilled workers to set up, for example, measuring instruments.

Class 1

Class 1 gauge blocks are used as working standards in inspection rooms within the production to set and calibrate measuring instruments and equipment as well as to inspect tools, fixtures and machines.

Class 0

Class 0 gauge blocks, with their high accuracy, are intended for use by measuring technicians in environmentally controlled inspection rooms, for example to calibrate measuring equipments.

Class K

Class K gauge blocks have the highest class of accuracy. They are *the* length standards in a calibration laboratory and other calibration values are derived from these gauges. Only with a UKAS certificate – or with another certificate, accepted by UKAS as equivalent (e.g. DAkkS, RvA and COFRAC) – will these gauge blocks be at their best. The most accurate gauges can meet a tolerance of $\pm 0.05 \mu\text{m}$.

Accuracy according ISO 3650

Nominal size mm	Class K		Class 0		Class 1		Class 2	
	Tolerance on nominal size μm	Deviation* μm	Tolerance on nominal size μm	Deviation* μm	Tolerance on nominal size μm	Deviation* μm	Tolerance on nominal size μm	Deviation* μm
0.5 - 10	± 0.20	0.05	± 0.12	0.10	± 0.20	0.16	± 0.45	0.30
10 - 25	± 0.30	0.05	± 0.14	0.10	± 0.30	0.16	± 0.60	0.30
25 - 50	± 0.40	0.06	± 0.20	0.10	± 0.40	0.18	± 0.80	0.30
50 - 75	± 0.50	0.06	± 0.25	0.12	± 0.50	0.18	± 1.00	0.35
75 - 100	± 0.60	0.07	± 0.30	0.12	± 0.60	0.20	± 1.20	0.35

* Deviation of the measuring face.

Steel gauge blocks

Steel gauge blocks delivered with an inspection report.

- Hardness measuring surfaces: 63-65 HRC.
- Expansion coefficient: $(12 \pm 1) \cdot 10^{-6}/^{\circ}\text{C}$.
- ISO 3650.



Steel gauge blocks in sets

Item No.	Class	Price EUR	Size mm	Increment mm	Pieces
M32:					
906.622	2	77.00	1.005	–	1
906.621	1	142.00	1.01 - 1.09	0.01	9
906.620	0	264.00	1 - 9	0.1	9
			10 - 30	1	9
			50	10	3
				–	1
M47:					
906.625	2	111.00	1.005	–	1
906.624	1	223.00	1.01 - 1.09	0.01	9
906.623	0	329.00	1.1 - 1.9	0.1	9
			1 - 24	1	24
			25 - 100	10	4
M87:					
906.613	2	188.00	1.001 - 1.009	0.001	9
906.612	1	391.00	1.01 - 1.49	0.01	49
906.611	0	742.00	0.5 - 9.5	0.5	19
			10 - 100	10	10
M88:					
906.628	2	182.00	1.0005	–	1
906.627	1	370.00	1.001 - 1.009	0.001	9
906.626	0	581.00	1.01 - 1.49	0.01	49
			0.5 - 9.5	0.5	19
			10 - 100	10	10
M112:					
906.631	2	279.00	1.0005	–	1
906.630	1	560.00	1.001 - 1.009	0.001	9
906.629	0	868.00	1.01 - 1.49	0.01	49
			0.5 - 24.5	0.5	49
			25 - 100	25	4

Steel gauge blocks, per piece

Size mm	Increment mm	ISO 3650/1 Price EUR	ISO 3650/0 Price EUR
0.5	–	18.90	22.30
1	–	9.60	14.20
1.0005	–	13.40	19.80
1.001 - 1.009	0.001	9.60	14.20
1.01 - 1.50	0.01	9.60	14.20
1.6 - 2.0	0.1	9.60	14.20
2.5 - 7.5	0.5	9.60	14.20
8.0 - 10.0	0.5	9.60	15.30
10.5 - 25.0	0.5	12.20	15.30
30	–	15.40	19.60
40	–	15.40	19.60
50	–	17.40	19.60
60	–	18.30	24.70
70	–	18.30	24.70
75	–	23.60	30.20
80	–	23.60	30.20
90	–	26.10	43.00
100	–	33.70	50.00

Select steel gauge blocks

The steel gauge blocks are available in all accuracy classes of ISO 3650. Only the most commonly used sizes can be found in this catalog. The gauge blocks are delivered with an inspection report or on request with a DAkkS certificate, UKAS acknowledged. Sets delivered in luxurious case. Special sizes and sets are available on request, as well as special sets for calibration of micrometers and calipers. High quality gauge blocks, can be very well wringed to make a combination size.



SELECT

Steel gauge blocks, per piece

Size mm	Increment mm	ISO 3650/1 Price EUR	ISO 3650/0 Price EUR
0.5	–	36.00	44.00
1	–	32.90	36.00
1.0005	–	36.00	44.00
1.001 - 1.009	0.001	32.90	36.00
1.01 - 1.5	0.01	29.80	32.90
1.6 - 1.9	0.1	29.80	32.90
2.0 - 5.5	0.5	32.90	36.00
6.0 - 10.0	0.5	32.90	36.00
10.5 - 15.0	0.5	34.40	39.10
15.5 - 20.0	0.5	34.40	39.10
20.5 - 25.0	0.5	34.40	39.10
30	–	36.00	44.00
40	–	36.00	44.00
50	–	36.00	44.00
60	–	36.00	44.00
70	–	36.00	44.00
75	–	39.10	45.00
80	–	41.00	54.00
90	–	41.00	54.00
100	–	45.00	61.00

Steel gauge blocks in sets

Item No.	Class	Price EUR	Size mm	Increment mm	Pieces
M32:					
831.915	1	732.00	1.005	–	1
831.914	0	865.00	1.01 - 1.09	0.01	9
			1.1 - 1.9	0.1	9
			1 - 9	1	9
			10 - 30	10	3
			60	–	1
M47:					
831.911	1	1,199.00	1.005	–	1
831.910	0	1,392.00	1.00 - 1.09	0.01	10
			1.1 - 1.9	0.1	9
			2 - 25	1	24
			50 - 100	25	3
M87:					
831.909	1	1,678.00	0.5	–	1
831.908	0	2,020.00	1.001 - 1.009	0.001	9
			1.00 - 1.50	0.01	51
			2.0 - 10.0	0.5	17
			20 - 100	10	9
M103:					
831.907	1	1,958.00	0.5	–	1
831.906	0	2,370.00	1.005	–	1
			1.00 - 1.50	0.01	51
			2.0 - 25.0	0.5	47
			50 - 100	25	3
M112:					
831.905	1	2,100.00	0.5	–	1
831.904	0	2,530.00	1.0005	–	1
			1.001 - 1.009	0.001	9
			1.00 - 1.50	0.01	51
			2.0 - 25.0	0.5	47
			50 - 100	25	3
M122:					
831.903	1	2,350.00	0.5	–	1
831.902	0	2,890.00	1.0005	–	1
			1.001 - 1.009	0.001	9
			1.00 - 1.50	0.01	51
			1.6 - 1.9	0.1	4
			2.0 - 25.0	0.5	47
			30 - 70	10	5
			75	–	1
			80 - 100	10	3

Tungsten carbide gauge blocks

Tungsten carbide gauge blocks with a low expansion coefficient. High resistance against corrosion. Delivered with an inspection report.

- Hardness measuring surfaces: 70 - 72 HRC.
- Expansion coefficient: $(8.5 \pm 1) \cdot 10^{-6} / ^\circ\text{C}$.
- ISO 3650.



Tungsten carbide gauge blocks, per piece

Size mm	Increment mm	ISO 3650/1 Price EUR	ISO 3650/0 Price EUR
0.5	–	31.20	40.00
1	–	31.20	40.00
1.0005	–	48.00	53.00
1.001 - 1.009	0.001	31.20	40.00
1.01 - 1.50	0.01	31.20	40.00
1.6 - 1.9	0.1	31.20	40.00
2.0 - 10.0	0.5	32.10	43.00
10.5 - 15.0	0.5	36.40	45.00
15.5 - 25.0	0.5	47.00	55.00
30	–	53.00	66.00
40	–	73.00	87.00
50	–	87.00	90.00
60	–	101.00	108.00
70	–	116.00	120.00
75	–	125.00	123.00
80	–	130.00	135.00
90	–	146.00	149.00
100	–	148.00	156.00

Tungsten carbide gauge blocks in sets

Item No.	Class	Price EUR	Size mm	Increment mm	Pieces
M32:			1.005	–	1
906.634	2	387.00	1.01 - 1.09	0.01	9
906.633	1	429.00	1.1 - 1.9	0.1	9
906.632	0	477.00	1 - 9	1	9
			10 - 30	10	3
			50	–	1
M47:			1.005	–	1
906.637	2	632.00	1.01 - 1.09	0.01	9
906.636	1	727.00	1.1 - 1.9	0.1	9
906.635	0	807.00	1 - 24	1	24
			25 - 100	25	4
M87:			1.001 - 1.009	0.001	9
906.662	2	848.00	1.01 - 1.49	0.01	49
906.661	1	1,084.00	0.5 - 9.5	0.5	19
906.660	0	1,215.00	10 - 100	10	10
M112:			1.0005	–	1
906.643	2	970.00	1.001 - 1.009	0.001	9
906.642	1	1,205.00	1.01 - 1.49	0.01	49
906.641	0	1,550.00	0.5 - 24.5	0.5	49
			25 - 100	25	4

Select tungsten carbide gauge blocks

The tungsten carbide gauge blocks are available in all accuracy classes of ISO 3650. Only the most commonly used sizes can be found in this catalog. The gauge blocks are delivered with an inspection report or on request with a DAkkS certificate, UKAS acknowledged. Sets delivered in luxurious case. Special sizes and sets are available on request. High quality gauge blocks, can be very well wringed to make a combination size.



SELECT

Tungsten carbide gauge blocks, per piece

Size mm	Increment mm	ISO 3650/1 Price EUR	ISO 3650/0 Price EUR
0.5	–	50.00	57.00
1	–	44.00	51.00
1.0005	–	44.00	51.00
1.001 - 1.009	0.001	44.00	51.00
1.01 - 1.50	0.01	42.00	49.00
1.6 - 1.9	0.1	42.00	49.00
2.0 - 5.5	0.5	43.00	50.00
6.0 - 10.0	0.5	55.00	61.00
10.5 - 15.0	0.5	65.00	69.00
15.5 - 20.0	0.5	75.00	77.00
20.5 - 25.0	0.5	91.00	97.00
30	–	105.00	110.00
40	–	132.00	138.00
50	–	143.00	149.00
60	–	157.00	163.00
70	–	171.00	176.00
75	–	176.00	182.00
80	–	183.00	190.00
90	–	190.00	195.00
100	–	197.00	201.00

Tungsten carbide gauge blocks in sets

Item No.	Class	Price EUR	Size mm	Increment mm	Pieces
M32:					
828.592	1	1,431.00	1.005	–	1
828.606	0	1,573.00	1.01 - 1.09	0.01	9
			1.1 - 1.9	0.1	9
			1 - 9	1	9
			10 - 30	10	3
			60	–	1
M46:					
828.590	1	2,540.00	1.001 - 1.009	0.001	9
828.604	0	2,770.00	1.00 - 1.09	0.01	10
			1.1 - 1.9	0.1	9
			2 - 10	1	9
			20 - 100	10	9
M47:					
828.589	1	2,520.00	1.005	–	1
828.603	0	2,700.00	1.00 - 1.09	0.01	10
			1.1 - 1.9	0.1	9
			2 - 25	1	24
			50 - 100	25	3
M87:					
828.587	1	3,970.00	0.5	–	1
828.601	0	4,400.00	1.001 - 1.009	0.001	9
			1.00 - 1.50	0.01	51
			2.0 - 10.0	0.5	17
			20 - 100	10	9
M103:					
828.585	1	4,860.00	0.5	–	1
828.599	0	5,320.00	1.005	–	1
			1.00 - 1.50	0.01	51
			2.0 - 25.0	0.5	47
			50 - 100	25	3
M112:					
828.584	1	5,180.00	0.5	–	1
828.598	0	5,690.00	1.0005	–	1
			1.001 - 1.009	0.001	9
			1.00 - 1.50	0.01	51
			2.0 - 25.0	0.5	47
			50 - 100	25	3
M122:					
828.583	1	6,050.00	0.5	–	1
828.597	0	6,590.00	1.0005	–	1
			1.001 - 1.009	0.001	9
			1.00 - 1.50	0.01	51
			1.6 - 1.9	0.1	4
			2.0 - 25.0	0.5	47
			30 - 70	10	5
			75	–	1
			80 - 100	10	3

Ceramic gauge blocks

These ceramic gauge blocks are made of high-tech material: Zirconia ceramics. Because of this, these gauge blocks are highly durable, corrosion proof and completely stable for long-term use. Delivered with an inspection report.

- Highly wear-resistant. Can be used 5 to 10 times longer than steel gauge blocks.
- Rustproof.
- Hardness: 88-90 HRC.
- Expansion coefficient: $(10 \pm 1) \cdot 10^{-6}/^{\circ}\text{C}$ (same as steel gauge blocks, therefore they can be used at the same time).
- ISO 3650.



Ceramic gauge blocks, per piece

Size mm	Increment mm	ISO 3650/1 Price EUR	ISO 3650/0 Price EUR
1.0005	–	41.00	42.00
0.5	–	39.90	42.00
1	–	37.60	40.00
1.01 - 1.49	0.01	20.20	21.40
1.5 - 1.9	0.1	20.20	21.40
2.0 - 5.5	0.5	22.00	23.50
6.0 - 9.5	0.5	33.00	37.40
10.0 - 20.0	0.5	41.00	41.00
20.5 - 25.0	0.5	43.00	44.00
30	–	50.00	56.00
40	–	55.00	55.00
50	–	59.00	59.00
60	–	63.00	66.00
70	–	68.00	73.00
75	–	71.00	75.00
80	–	73.00	79.00
90	–	80.00	85.00
100	–	82.00	91.00

Ceramic gauge blocks in sets

Item No.	Class	Price EUR	Size mm	Increment mm	Pieces
M32:			1.005	–	1
906.646	1	797.00	1.01 - 1.09	0.01	9
906.645	0	997.00	1.1 - 1.9	0.1	9
			1 - 9	1	9
			10 - 30	10	3
			50	–	1
M47:			1.005	–	1
906.649	1	1,319.00	1.01 - 1.09	0.01	9
906.648	0	1,445.00	1.1 - 1.9	0.1	9
			1 - 24	1	24
			25 - 100	25	4
M87:			1.001 - 1.009	0.001	9
906.652	1	2,660.00	1.01 - 1.49	0.01	49
906.651	0	2,690.00	0.5 - 9.5	0.5	19
			10 - 100	10	10
M103:			1.005	–	1
906.655	1	2,670.00	1.01 - 1.49	0.01	49
906.654	0	3,060.00	0.5 - 24.5	0.5	49
			25 - 100	25	4
M112:			1.0005	–	1
906.658	1	2,730.00	1.001 - 1.009	0.001	9
906.657	0	3,300.00	1.01 - 1.49	0.01	49
			0.5 - 24.5	0.5	49
			25 - 100	25	4

Select ceramic gauge blocks

The ceramic gauge blocks are available in all accuracy classes of ISO 3650. Only the most commonly used sizes can be found in this catalog. The gauge blocks are delivered with an inspection report or on request with a DAkkS certificate, UKAS acknowledged. Sets delivered in luxurious case. Special sizes and sets are available on request, as well as special sets for calibration of micrometers and calipers. High quality gauge blocks, can be very well wringed to make a combination size.

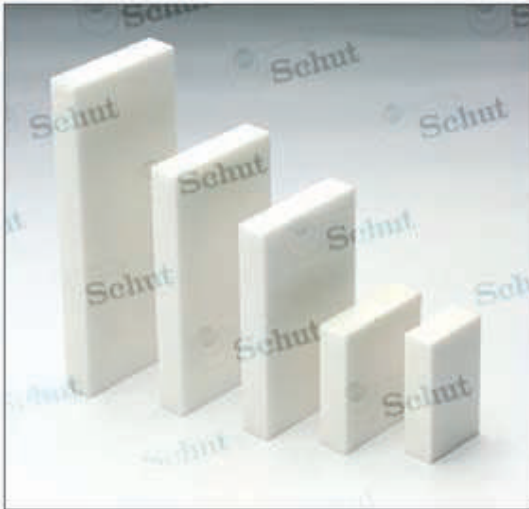

Ceramic gauge blocks in sets

Item No.	Class	Price EUR	Size mm	Increment mm	Pieces
M32:					
831.085	1	1,713.00	1.005	–	1
831.084	0	1,945.00	1.01 - 1.09	0.01	9
			1.1 - 1.9	0.1	9
			1 - 9	1	9
			10 - 30	10	3
			60	–	1
M47:					
831.081	1	2,890.00	1.005	–	1
831.080	0	3,600.00	1.00 - 1.09	0.01	10
			1.1 - 1.9	0.1	9
			2 - 25	1	24
			50 - 100	25	3
M87:					
831.079	1	3,480.00	0.5	–	1
831.078	0	4,170.00	1.001 - 1.009	0.001	9
			1.00 - 1.50	0.01	51
			2.0 - 10.0	0.5	17
			20 - 100	10	9
M103:					
831.077	1	4,220.00	0.5	–	1
831.076	0	5,060.00	1.005	–	1
			1.00 - 1.50	0.01	51
			2.0 - 25.0	0.5	47
			50 - 100	25	3
M112:					
831.075	1	4,450.00	0.5	–	1
831.074	0	5,340.00	1.0005	–	1
			1.001 - 1.009	0.001	9
			1.00 - 1.50	0.01	51
			2.0 - 25.0	0.5	47
			50 - 100	25	3
M122:					
831.073	1	4,870.00	0.5	–	1
831.072	0	5,970.00	1.0005	–	1
			1.001 - 1.009	0.001	9
			1.00 - 1.50	0.01	51
			1.6 - 1.9	0.1	4
			2.0 - 25.0	0.5	47
			30 - 70	10	5
			75	–	1
			80 - 100	10	3

Ceramic gauge blocks, per piece

Size mm	Increment mm	ISO 3650/1 Price EUR	ISO 3650/0 Price EUR
0.5	–	37.30	57.00
1	–	31.20	43.00
1.0005	–	32.70	43.00
1.001 - 1.009	0.001	32.70	43.00
1.01 - 1.50	0.01	32.70	43.00
1.6 - 1.9	0.1	32.70	43.00
2.0 - 5.5	0.5	35.80	50.00
6.0 - 10.0	0.5	37.30	54.00
10.5 - 15.0	0.5	43.00	60.00
15.5 - 20.0	0.5	47.00	60.00
20.5 - 25.0	0.5	54.00	71.00
30	–	57.00	73.00
40	–	70.00	94.00
50	–	80.00	111.00
60	–	84.00	122.00
70	–	94.00	133.00
75	–	105.00	147.00
80	–	111.00	162.00
90	–	120.00	173.00
100	–	124.00	177.00

SELECT/

Mitutoyo steel and ceramic gauge blocks

The Mitutoyo gauge blocks are available in all accuracy classes of ISO 3650. Only the most commonly used sizes can be found in this catalog. Other accuracy classes and sizes are available on request. Gauge blocks from 125 mm have two coupling holes on both ends so that they can be coupled by means of a toggle clamp. Individual gauge blocks and sets are delivered with an inspection report.

Steel

These gauge blocks are made of alloy steel, and they are completely stress-relieved and very stable.

- Hardness: 800 HV.
- Available up to 1000 mm.
- Sets M8, M9, M103, M112 and M122 are available on request.

Ceramics

The ceramic gauge blocks are made of zirconia. Because of this, these gauge blocks are highly durable and corrosion proof.

- Hardness: 1350 HV.
- Available up to 500 mm.
- Sets M8 and M103 are available on request.

Gauge blocks, per piece

Size mm	Incr. mm	Steel		Ceramics	
		Class 1	Class 0	Class 1	Class 0
0.5	–	33.00	40.00	43.00	47.00
1	–	22.00	26.00	36.00	40.00
1.0005	–	22.00	26.00	36.00	40.00
1.001-1.009	0.001	22.00	26.00	36.00	40.00
1.01-1.49	0.01	22.00	26.00	36.00	40.00
1.5-2.0	0.1	22.00	27.00	37.00	41.00
2.5	–	24.00	28.00	40.00	44.00
3.0-4.0	0.5	24.00	28.00	41.00	45.00
4.5-5.0	0.5	24.00	29.00	45.00	49.00
5.5-10.0	0.5	29.00	35.00	49.00	54.00
10.5-11.0	0.5	31.00	37.00	69.00	76.00
11.5-12.5	0.5	37.00	44.00	71.00	79.00
13.0-15.5	0.5	38.00	45.00	78.00	86.00
16	–	39.00	47.00	85.00	94.00
16.5-17.5	0.5	40.00	48.00	87.00	96.00
18.0-20.0	0.5	40.00	48.00	91.00	100.00
20.5-23.0	0.5	41.00	49.00	97.00	107.00
23.5-24.5	0.5	43.00	52.00	105.00	115.00
25	–	44.00	52.00	108.00	119.00
30	–	50.00	59.00	119.00	131.00
40	–	55.00	65.00	139.00	153.00
50	–	62.00	74.00	161.00	177.00
60	–	71.00	85.00	181.00	199.00
70	–	78.00	93.00	201.00	221.00
75	–	80.00	96.00	155.00	155.00
80	–	86.00	104.00	222.00	245.00
90	–	90.00	108.00	243.00	267.00
100	–	95.00	114.00	264.00	290.00



Gauge blocks in sets

Item No.	Class	Price EUR	Size mm	Increment mm	Pieces
M32, steel:			1.005	–	1
517.967	1	793.00	1.01-1.09	0.01	9
517.966	0	1,093.00	1.1-1.9	0.1	9
M32, ceramics:			1-9	1	9
516.367	1	1,233.00	10-30	10	3
516.366	0	1,554.00	60	–	1
M46, steel:			1.001-1.009	0.001	9
516.996	1	1,350.00	1.01-1.09	0.01	9
516.995	0	1,696.00	1.1-1.9	0.1	9
M46, ceramics:			1-9	1	9
516.396	1	2,250.00	10-100	10	10
516.395	0	2,680.00			
M47, steel:			1.005	–	1
516.963	1	1,316.00	1.01-1.19	0.01	19
517.962	0	1,729.00	1.2-1.9	0.1	8
M47, ceramics:			1-9	1	9
516.363	1	2,197.00	10-100	10	10
516.362	0	2,628.00			
M87, steel:			1.001-1.009	0.001	9
516.947	1	1,822.00	1.01-1.49	0.01	49
516.946	0	2,787.00	0.5-9.5	0.5	19
M87, ceramics:			10-100	10	10
516.347	1	3,536.00			
516.346	0	4,448.00			

Long gauge blocks from 125 mm

These steel gauge blocks are available in the accuracy classes 0, 1 and 2 of ISO 3650. All gauge blocks have two coupling holes on both ends so that they can be coupled by means of a toggle clamp. Delivered with an inspection report.

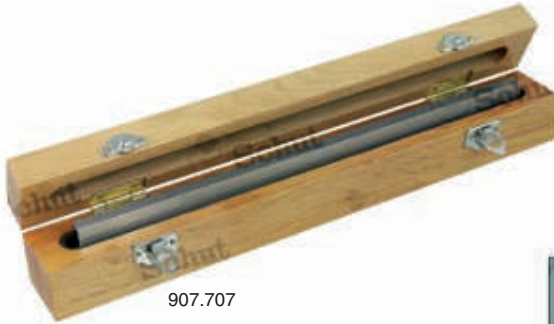

907.707



907.741

 PRICE

Size/mm	Item No.	Price EUR	Item No.	Price EUR	Item No.	Price EUR
	ISO 3650/2:		ISO 3650/1:		ISO 3650/0:	
125	907.728	48.00	907.715	57.00	907.702	97.00
150	907.729	78.00	907.716	80.00	907.703	146.00
175	907.730	80.00	907.717	94.00	907.704	156.00
200	907.731	86.00	907.718	107.00	907.705	160.00
250	907.732	96.00	907.719	128.00	907.706	200.00
300	907.733	137.00	907.720	137.00	907.707	307.00
400	907.734	156.00	907.721	240.00	907.708	320.00
500	907.735	173.00	907.722	360.00	907.709	413.00
600	907.736	444.00	907.723	660.00	907.710	856.00
700	907.737	470.00	907.724	702.00	907.711	1,096.00
800	907.738	562.00	907.725	810.00	907.712	1,342.00
900	907.739	728.00	907.726	997.00	907.713	1,493.00
1000	907.740	810.00	907.727	1,137.00	907.714	1,750.00
Gauge block set consisting of 125, 150, 175, 200, 250, 300, 400 and 500 mm:						
	907.743	506.00	907.742	634.00	907.741	1,212.00
Gauge block set consisting of 600, 700, 800, 900 and 1000 mm:						
	907.746	2,280.00	907.745	3,460.00	907.744	5,350.00

Select long gauge blocks from 125 mm

These steel gauge blocks are available in the accuracy classes 0, 1 and 2 of ISO 3650, equal to DIN 861. The gauge blocks are delivered with an inspection report or on request with a DAkkS certificate, UKAS acknowledged. All gauge blocks have two coupling holes on both ends so that they can be coupled by means of a toggle clamp.



831.937

SELECT!

Size/mm	Item No.	Price EUR	Item No.	Price EUR	Item No.	Price EUR
	ISO 3650/2:		ISO 3650/1:		ISO 3650/0:	
125	831.019	195.00	831.008	247.00	831.000	283.00
150	831.020	208.00	831.009	263.00	831.001	302.00
175	831.021	249.00	831.010	307.00	831.002	358.00
200	831.022	268.00	831.011	319.00	831.003	383.00
250	831.023	300.00	831.012	375.00	831.936	419.00
300	831.024	336.00	831.013	403.00	831.937	477.00
400	831.025	396.00	831.981	498.00	831.946	570.00
500	831.026	433.00	831.738	575.00	831.004	686.00
600	831.027	668.00	831.014	773.00	831.947	924.00
700	831.028	792.00	831.015	935.00	831.005	1,116.00
800	831.029	1,003.00	831.016	1,193.00	831.948	1,478.00
900	831.030	1,235.00	831.017	1,527.00	831.006	1,926.00
1000	831.031	1,553.00	831.018	1,883.00	831.007	2,460.00
Gauge block set consisting of 125, 150, 175, 200, 250, 300, 400 and 500 mm:						
	831.088	2,580.00	831.087	3,240.00	831.086	3,780.00
Gauge block set consisting of 600, 700, 800, 900 and 1000 mm:						
	831.091	6,470.00	831.090	7,640.00	831.089	9,380.00

Mitutoyo toggle clamp for long series gauge blocks

Toggle clamp for the coupling of gauge blocks over 100 mm which have coupling holes on both ends. Very quick assembly by means of spring clamping device (with locking screw).

Item No.	Description	Price EUR
619.031	Toggle clamp for long series gauge blocks	129.00



Gauge block accessories

Various accessories to extract the resulting size of one or more gauge blocks outside or to convert it into an inside gauge. This also enables the creation of setting gauges and marking tools. These accessories considerably increase the applicability of standard gauge blocks.



907.204



907.202



907.210



907.209



907.207

Item No.	Description	Price EUR	Set		
			M8	M10	M12
Holder for gauge blocks:					
907.203	Up to 50 mm	25.00	•	•	•
907.204	Up to 100 mm	28.90	•	•	•
907.205	Up to 200 mm	44.00	•	•	•
Pair of measuring jaws, with measuring faces:					
907.206	Cylindrical \varnothing 2 mm and flat ($l=40$ mm)	61.00	•	•	•
907.207	Cylindrical \varnothing 5 mm and flat ($l=45$ mm)	59.00	•	•	•
907.208	Cylindrical \varnothing 10 mm and flat ($l=70$ mm)	50.00		•	•
907.209	Flat ($l=100$ mm, $h=19$ mm)	67.00		•	•
907.213	V-shaped ($l=60$ mm, max. $\varnothing 60$ mm)	30.90		•	•
907.210	Straight edge ($l=100$ mm)	10.30			•
907.211	Scriber ($l=45$ mm)	27.50	•	•	•
907.212	Center point ($l=45$ mm)	55.00	•	•	•
907.214	Base for holder ($h=25$ mm)	128.00	•		•
Accessory sets, delivered in a case:					
907.200	M8	474.00	↑	↑	↑
907.201	M10	638.00		↑	↑
907.202	M12	653.00			↑



907.213



907.211

907.212

Caliper inspection set

For checking the accuracy of DIN 862 calipers. The set consists of three special steel gauge blocks (30 mm, 41.3 mm and 131.4 mm, ISO 3650 class 1), two steel setting rings ($\varnothing 4$ mm and $\varnothing 25$ mm) and a pair of gloves.



Item No.	Description	Price EUR
909.347	Caliper inspection set	237.00

Gloves

Comfortable, smooth, lint-free gloves with universal, perfect fit. Ideal for handling gauge blocks and other measuring instruments.

- Perfect thermal isolation.
- Washing machine safe.



Item No.	Description	Price EUR
191.069	Pair of gloves	7.20

Micrometer inspection sets

For the inspection of micrometers according to DIN 863. Suitable for micrometers with a measuring range up to 25 mm.

- Nominal sizes (mm): 2.5-5.1-7.7-10.3-12.9-15.0-17.6-20.2-22.8-25.0.
- Including plan parallel optical flat $\varnothing 30 \times 12$ mm.



909.340



Item No.	Material	Grade	Price EUR
909.346	steel	1	201.00
909.345	steel	0	267.00
909.162	ceramic	1	432.00
909.340	ceramic	0	499.00

Select microfibre cleaning cloth

Microfibre cleaning cloth for gauge blocks. Ideal for measuring rooms.

- Dimensions: 22.5 x 22.5 cm.



Item No.	Description	Price EUR
831.739	Microfibre cleaning cloth	5.70

Mitutoyo maintenance kit for steel gauge blocks

Contains all necessary requirements for the use, and maintenance, of steel gauge block.

The maintenance kit consists of:

- whetstone "Cerastone", 100 x 25 x 12 mm,
- pair of tweezers,
- dust remover,
- cleaning cloths,
- washleather,
- pipette bottle for solvent, 100 ml,
- pair of gloves,
- case.



Item No.	Description	Price EUR
516.650	Maintenance kit for steel gauge blocks	515.00

Mitutoyo micrometer inspection sets

These sets are composed for the inspection of micrometers according DIN 863. Micrometers with a measuring range over 25 mm can be inspected if an extra gauge block of 25, 50 or 75 mm is used in addition to the gauge blocks in these sets. Each set consists of ten special gauge blocks and a plan parallel optical flat.

- Nominal sizes (mm):
2.5-5.1-7.7-10.3-12.9-15.0-17.6-20.2-22.8-25.0.
- Including plan parallel optical flat $\varnothing 30 \times 12$ mm.

516.156

Item No.	Material	Grade	Price EUR
516.107	steel	1	504.00
516.106	steel	0	578.00
516.157	ceramic	1	770.00
516.156	ceramic	0	968.00



Mitutoyo caliper inspection set

For checking the accuracy of DIN 862 calipers.

The set consists of three special steel gauge blocks (30 mm, 41.3 mm and 131.4 mm, ISO 3650 class 1), two steel setting rings ($\varnothing 4$ mm and $\varnothing 25$ mm) and a pair of gloves.

- Delivery in a case with a manufacturer's certificate for the gauge blocks.

Item No.	Description	Price EUR
516.124	Caliper inspection set	815.00



Angle gauge block set

Set of twelve hardened steel angle gauge blocks, comprising the angles $\frac{1}{4}^\circ$ (15'), $\frac{1}{2}^\circ$ (30'), 1° , 2° , 3° , 4° , 5° , 10° , 15° , 20° , 25° and 30° . A combination of angle gauge blocks is possible.

- Accuracy: $\pm 30''$.
- Thickness gauge blocks: 6 mm.
- Delivery in a case with a manufacturer's certificate.



NEW



Item No.	Description	Price EUR
909.799	Angle gauge block set	76.00

Steel measuring balls

Set of steel measuring balls for measuring e.g. internal tapers. This set contains of a series of balls of different sizes, with two balls of each size.

- Accuracy: $\pm 3 \mu\text{m}$.
- Two balls of each size.
- Delivery in a plastic case with a manufacturer's certificate.



NEW



Item No.	Size mm	Incr. mm	Per size	Total number	Price EUR
909.647	1 - 25	1	2	50	131.00

Select steel angle gauge blocks

The gauge blocks are delivered with an inspection report or on request with a DAkkS certificate, UKAS acknowledged. Special sizes and sets are available on request.

- Angle gauge blocks: 10" to 80° available.
- Accuracy: $\pm 2''$.
- Cross-section: 50 x 9 mm.
- Delivery in a case.
- Also available in sets.



Steel angle gauge blocks, per piece

Category	Angle	Item No.	Description	Price EUR
10" - 5°	10", 30", 1', 2', 3', 4', 5', 10', 20', 30', 40', 50', 1°, 2°, 3°, 4°, 5°	831.424	Angle gauge block 10"	891.00
10° - 15°	10°, 15°	831.441	Angle gauge block 10°	1,076.00
20° - 30°	20°, 30°	831.442	Angle gauge block 20°	1,276.00
40° - 80°	40°, 45°, 50°, 60°, 70°, 80°	831.443	Angle gauge block 40°	1,507.00

Schwenk carbide precision measuring balls

The carbide measuring balls are excellent wear-proof and corrosion resistant and are supplied in accuracy class 25. Suitable for various precision applications.

- Standard supplied: \varnothing 1 - 26 mm,
 \varnothing 1 - 12 mm, increment 0.5 mm,
 \varnothing 13 - 26 mm, increment 1 mm
Other sizes and intermediate dimensions are available on request.
- Hardness: HV 1550 \pm 50.
- On request available in ruby or ceramic version.



Optical flats

Optical flats can be used for inspection of the flatness of reflecting surfaces of for example gauge blocks, settings gauges and other lapped surfaces by optical interference.

- Flatness measuring faces: $\leq 0.15 \mu\text{m}$.
- Parallelism measuring faces: $\leq 0.3 \mu\text{m}$ (only 826.630/631/632/633/634).
- On request with a DAkkS certificate, UKAS acknowledged.
- Delivery in a case.



Item No.	Diameter mm	Thickness mm	Price EUR
Single optical flats, single face:			
826.625	30	15	54.00
826.626	45	15	65.00
826.627	50	20	112.00
826.628	60	20	123.00
826.629	75	20	131.00
Single optical flats, double face:			
826.630	30	12	165.00
826.631	45	15	119.00
826.632	50	20	173.00
826.633	60	20	181.00
826.634	75	20	189.00



826.626

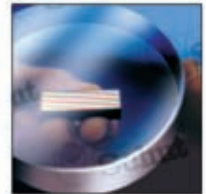

Plan parallel optical flats

Plan parallel optical flats can be used for inspection of the parallelism of measuring surfaces of micrometers and other measuring instruments. Each set consists of 4 sizes plan parallel optical flats for inspection of micrometers on every fourth rotation of the spindle.

- For micrometers with a spindle pitch of 0.5 mm.
- Sets for micrometers with a measuring range of 0-25 mm, 25-50 mm, 50-75 mm and 75-100 mm.
- Flatness measuring faces: $\leq 0.15 \mu\text{m}$.
- Parallelism measuring faces: $\leq 0.3 \mu\text{m}$.
- Diameter: 30 mm.
- On request with a DAkkS certificate, UKAS acknowledged.
- Delivery in a case.



826.635

Item No.	Thicknesses/mm	Price EUR
826.635	12.00/12.12/12.25/12.37	289.00
826.636	25.00/25.12/25.25/25.37	346.00
907.909	50.00/50.12/50.25/50.37	592.00
907.910	75.00/75.12/75.25/75.37	740.00

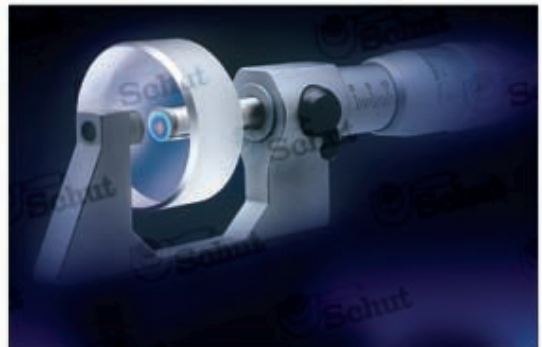

TESA optical flats

For examining flatness and wringability of gauge blocks.

- Delivery in a case with a declaration of conformity.

Item No.	Diameter mm	Thickness mm	Flatness deviation/ μm	Price EUR
780.386	50	15	0.125	349.00
780.387	75	20	0.125	672.00



TESA plan parallel optical flats

For examining deviations in flatness and parallelism of the measuring faces of micrometers and other similar instruments.

- Max. flatness deviation:
12.00-27.335 mm: 0.15 μm .
52.00-77.335 mm: 0.2 μm .
- Max. parallelism deviation:
12.00-27.335 mm: 0.4 μm .
52.00-77.335 mm: 0.5 μm .
- Diameter: 31 mm.
- Delivery of the sets in a case with a declaration of conformity.

780.352



Item No.	Thicknesses/mm	Price EUR
Sets:		
780.352	12.00-12.375 (4 pcs.)	515.00
780.357	27.00-27.335 (3 pcs.)	550.00
780.361	52.00-52.335 (3 pcs.)	698.00
780.365	77.00-77.335 (3 pcs.)	858.00
780.353	12.00	144.00
780.358	27.00	187.00

How to use an optical flat

Interference fringes appear in monochromatic light when the optical flat is laid on and wiggled against the surface to be tested. The difference in height between adjacent fringes corresponds to an error in flatness of approx. 0.3 μm .

In the event of a constant distance between the interference fringes, the angle between the measuring face of the optical flat and the surface to be tested is constant (fig. 1).

However, interference fringes do not usually have an even interspacing. When the fringes are close together the angle between the measuring face and the surface to be tested is large (fig. 2). In this case the surface to be tested is either convex (fig. 2) or concave (fig. 3). The deviation in flatness can be "measured" by counting the interference fringes.

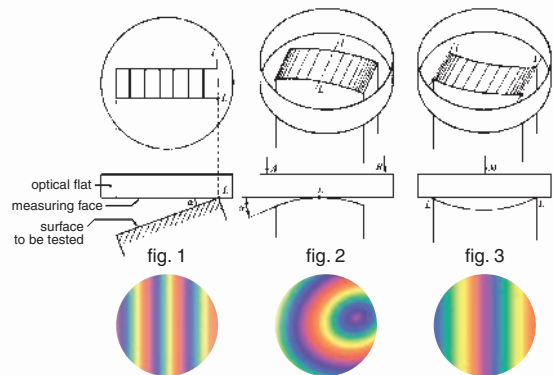

Feeler gauges

Feeler gauge sets in a holder, for individual use or in combination to measure slits and gaps and also for checking the amount of clearance in sliding guides, bearings, pistons etc.

- Measuring range: 0.03 - 2.00 mm.
- Blade length: 100 mm.
- Nickel plated handle with locking screw.
- Blade width: 10 mm (except stainless steel models: 12 mm), tapered.
- Also available in brass model (anti-magnetic).



910.020



Item No.	Number of blades	Increment(s)				Material	Price EUR
		0.01 mm	0.02 mm	0.05 mm	0.10 mm		
909.904	8			0.05 → 0.30	0.40 → 0.50	hardened steel	1.60
909.905	8			0.05 → 0.30	0.40 → 0.50	stainless steel	4.20
909.906	8			0.05 → 0.30	0.40 → 0.50	brass	5.50
909.907	13			0.05 → 0.30	0.40 → 1.00	hardened steel	1.80
909.908	13			0.05 → 0.30	0.40 → 1.00	stainless steel	4.60
909.909	13			0.05 → 0.30	0.40 → 1.00	brass	8.40
910.019	20			0.05 → 1.00		hardened steel	2.90
910.020	20			0.05 → 1.00		stainless steel	6.90
910.021	20			0.05 → 1.00		brass	13.00
910.022	8	0.03 → 0.10				hardened steel	1.60
910.023	10	0.03 → 0.05		0.10 → 0.30	0.40 → 0.50	hardened steel	1.80
910.024	10				0.10 → 1.00	hardened steel	1.80
910.026	14	0.03 → 0.10		0.15 → 0.30	0.40 → 0.50	hardened steel	1.80
910.027	18	0.05 → 0.10		0.15 → 0.40	0.50 → 1.00	hardened steel	2.60
910.028	19	0.03 → 0.10		0.15 → 0.30	0.40 → 1.00	hardened steel	2.90
910.029	20	0.04 → 0.10		0.15 → 0.50	0.60 → 1.00	hardened steel	2.90
908.978	22	0.03 → 0.05		0.10 → 1.00		hardened steel	3.20
908.979	28	0.03 → 0.10	0.12 → 0.50			hardened steel	4.70
910.034	21			0.05 → 0.10	0.20 → 2.00	hardened steel	5.30

Feeler gauges

- Measuring range: 0.05 - 1.00 mm;
20 blades: 0.05 / 0.10 → 1.00.
- Material: hardened steel.
- Blade width: 12.8 mm.



NEW



910.031

Item No.	Blade length/mm	Price EUR
910.030	200	9.80
910.031	300	13.90
910.032	400	20.80
910.033	500	22.40

HELIOS-PREISSER feeler stock coils

Feeler stock coils made of steel.

- Measuring range: 0.005 - 1.00 mm.
- Length: 5 m.
- Width: 13 mm.
- Other widths or material (stainless steel or brass) available on request.



856.045



856.030



856.032

Item No.	Thickness/mm	Price EUR
856.036	0.005	76.00
856.037	0.01	30.00
856.038	0.02	24.90
856.039	0.03	8.60
856.040	0.04	8.60
856.041	0.05	6.50
856.042	0.06	6.80
856.043	0.07	6.80
856.044	0.08	6.80
856.045	0.09	6.80
856.046	0.10	5.80
856.047	0.12	5.80
856.048	0.15	5.80
856.049	0.18	7.60
856.050	0.20	5.80
856.051	0.25	5.80
856.052	0.30	6.70
856.053	0.35	6.70
856.054	0.40	7.70
856.055	0.45	7.70
856.056	0.50	7.70
856.057	0.55	9.90
856.058	0.60	9.90
856.059	0.65	9.90
856.060	0.70	9.90
856.061	0.75	9.90
856.062	0.80	9.90
856.063	0.85	10.10
856.064	0.90	10.60
856.065	0.95	10.60
856.066	1.00	10.60

Options

Item No.	Description	Price EUR
856.030	Set 0.01 - 0.25 mm	149.00
856.031	Set 0.3 - 1.00 mm	169.00
856.032	Holder for feeler stock coils	2.60

Gauges / Pin gauges / Thread and tolerance tables



C12.001-EN-20170420

Limit gauges for internal and external dimensions

The manufacturing tolerance and the permissible reduction in wear for plain gauges are laid down in DIN 7162.

New gauges are supplemented with a wear allowance on the Go end: z (plus) for plug gauges and z_1 (minus) for ring gauges. Accordingly, the size indicated on the handle is not similar to the measured value of the new Go end.

Example: plug gauge 30 H9

New Go end:

size	30.000 mm
wear allowance (+z)	<u>0.009 mm</u>
	30.009 mm
manufacturing tolerance	± 0.002 mm
largest value measured	30.011 mm
smallest value measured	30.007 mm

The gauges are also available without wear allowance (additional cost). This should be indicated when ordering.

Plug gauges

Manufactured according DIN 2245, 2246 and 2247. Available from 0.5 to 250 mm; up to 70 mm with Go and NoGo on one handle, over 70 mm in two parts. Prices are for H7 plug gauges with Go and NoGo ends in hardened steel.

Also available:

- other fit sizes, like H6 and H8,
- hard-chrome plated plug gauges,
- tungsten carbide plug gauges,
- extended plug gauges,
- plug gauges with vent hole,
- plug gauges with easy-entry pilot,
- flat plug gauges,
- square and hexagonal plug gauges.



Size H7/mm	Price EUR	Size H7/mm	Price EUR	Size H7/mm	Price EUR	Size H7/mm	Price EUR
1	26.10	14	19.90	34	32.40	65	60.00
1.5	23.90	15	20.50	35	33.10	68	64.00
2	21.00	16	21.00	36	33.60	70	65.00
2.5	21.00	17	21.60	37	34.20	72	68.00
3	18.30	18	22.10	38	35.30	75	71.00
3.5	16.50	19	22.80	40	36.40	78	74.00
4	16.50	20	22.80	42	37.60	80	75.00
4.5	16.50	21	23.90	44	39.80	82	81.00
5	15.40	22	24.50	45	41.00	85	83.00
5.5	15.40	23	25.00	46	42.00	88	87.00
6	15.40	24	25.60	47	43.00	90	89.00
7	15.90	25	26.10	48	44.00	92	91.00
8	16.50	26	26.70	50	46.00	95	94.00
9	17.00	27	27.30	52	48.00	98	97.00
10	17.70	28	27.90	55	50.00	100	100.00
11	18.30	30	28.50	58	54.00		
12	18.80	32	30.70	60	56.00		
13	19.40	33	31.80	62	58.00		
						Larger sizes available on request	

Measuring reports

For all gauges also measuring reports can be ordered.

- ① Inspection report (German) per gauge. Stating of product specifications, measured values after production, used traceable measuring devices, measuring inaccuracy and measuring date. A favourable choice when your quality system does not require traceable certificates.
- ② Traceable certificate (Dutch) with measuring reports of the ordered gauges. Besides stating of the measured values the extra assurance of an external inspection.

Pin gauges

Swiss made, hardened and ground steel pin gauges; available loose and in sets.

- Hardened, ground, and seasoned steel.
- Diameter range:
 - without handle: 0.06 - 20.00 mm,
 - with handle: 0.06 - 10.00 mm.
- Increment: 0.01 mm.
- Accuracy: ± 0.0015 mm.
- Pin gauges $\phi 5.00 - 20.00$ mm
 - without handle: indication on head.



Also available:

With an accuracy of ± 0.0003 or ± 0.001 mm;
 – hardened steel $\phi 0.06 - 20.00$ mm,
 – tungsten carbide or ceramics $\phi 0.50 - 9.99$ mm,
 with 0.01 mm increments. The length may deviate. More information available on request.

Diameter/mm	Length/mm	Price EUR
Pin gauge without handle:		
0.06- 0.09 ¹	30	101.00
0.10- 0.19 ¹	40	73.00
0.20- 0.29 ¹	40	45.00
0.30- 0.49 ¹	40	25.70
0.50- 0.99 ¹	40	14.50
1.00- 2.99	70	11.20
3.00- 4.00	70	14.50
4.01- 5.00	70	14.50
5.01- 5.99	70	14.50
6.00- 9.99	70	19.20
10.00- 11.99	70	23.10
12.00- 13.99	70	26.70
14.00- 15.99	70	33.30
16.00- 18.99	70	41.00
19.00- 20.00	70	47.00

Pin gauge with handle²:		
0.06- 0.09 ¹	23	114.00
0.10- 0.19 ¹	33	85.00
0.20- 0.29 ¹	33	58.00
0.30- 0.49 ¹	33	33.20
0.50- 0.99 ¹	33	22.00
1.00- 2.99	62	18.70
3.00- 4.00	62	34.40
4.01- 5.00	62	34.40
5.01- 5.99	62	34.40
6.00- 10.00	62	39.10

¹ Delivery in plastic transport case.

² The length here indicates the measuring length and not the total length of the pin gauges.

Item No.	Description	Price EUR
Wooden case (tubes not included):		
833.211	For 50 pin gauges $\phi 0.10 - 10.00$ mm without handle	135.00
833.704	For 100 pin gauges $\phi 0.10 - 10.00$ mm without handle	239.00
833.264	For 50 pin gauges $\phi 0.10 - 10.00$ mm with handle	160.00
833.118	For 40 pin gauges $\phi 10.01 - 15.00$ mm	156.00
833.705	For 80 pin gauges $\phi 10.01 - 15.00$ mm	258.00
833.706	For 30 pin gauges $\phi 15.01 - 20.00$ mm	258.00
Pin gauge tube for pin gauges¹:		
833.066	Without handle up to $\phi 0.99$ mm	1.90
838.224	Without handle $\phi 1.00 - 7.00$ mm	1.90
838.089	With handle up to $\phi 0.99$ mm	1.80
834.386 ²	Base inscription per size	2.50

¹ For insert in wooden case.

² For size indication in wooden case.



Pin gauges in sets

- Hardened, ground, and seasoned steel.
- Diameter range: 0.10- 10.00 mm.
- Increment: 0.01 mm.
- Accuracy: ± 0.0015 mm.
- Without handle.
- Pin gauges $\phi 5.00$ - 10.00 mm: indication on head.
- Length: $\phi 0.10$ - 0.99 mm: 40 mm,
 $\phi 1.00$ - 10.00 mm: 70 mm.
- Sets with larger diameters and/or with handle are available on request.



Set pin gauges without handle

Item No.	Diameter mm	Increment mm	Number per set	Price* EUR
833.901	0.10- 1.00	0.01	91	1,792.00
833.902	1.00- 2.00	0.01	101	1,191.00
833.903	2.00- 3.00	0.01	101	1,180.00
833.904	3.00- 4.00	0.01	101	1,464.00
833.905	4.00- 5.00	0.01	101	1,464.00
833.906	5.00- 6.00	0.01	101	1,464.00
833.907	6.00- 7.00	0.01	101	1,792.00
833.908	7.00- 8.00	0.01	101	1,792.00
833.909	8.00- 9.00	0.01	101	1,792.00
833.910	9.00- 10.00	0.01	101	1,792.00
834.190	1.00- 10.00	0.10	91	1,409.00

* Prices per set, in wooden case.



Individual pin gauges without handle

Pin gauges accessories

Interchangeable handles

- For pin gauges without handle.



Item No.	For diameter/mm	Price EUR
836.043	0.40-0.80	7.70
834.172	0.80-1.30	7.70
836.044	1.30-1.80	7.70
836.045	1.80-2.30	7.70
837.615	2.30-2.80	7.70
837.956	2.80-3.30	7.70
837.957	3.30-3.80	7.70
837.958	3.80-4.30	7.70
837.959	4.30-4.80	7.70
837.960	4.80-5.30	7.70

Holders for Go/NoGo determination

- For two pin gauges without handle.
- With NoGo indication.



Item No.	For diameter/mm	Price EUR
833.310	1.00- 2.00	26.40
833.311	2.00- 4.00	29.30
833.312	4.00- 6.00	54.00
833.313	6.00- 8.00	73.00
833.314	8.00- 10.00	82.00



Plug gauges

Ground and lapped, hardened tool steel plug gauges with a high accuracy. Available per piece and in sets. Swiss made.

- Diameter range: \varnothing 0.06 - 10.00 mm.
- Increment: 0.01 mm.
- Accuracy: \pm 0.0005 mm.
- Hardened tool steel.
Ground and lapped.
- Measuring length (and total length):
 - \varnothing 0.06 - 0.30 mm: 2 mm (34 mm),
 - \varnothing 0.31 - 0.50 mm: 3.5 mm (35.5 mm),
 - \varnothing 0.51 - 1.50 mm: 5 mm (37 mm),
 - \varnothing 1.51 - 2.00 mm: 6 mm (38 mm),
 - \varnothing 2.01 - 3.50 mm: 8 mm (43 mm),
 - \varnothing 3.51 - 6.00 mm: 10 mm (55 mm),
 - \varnothing 6.01 - 8.00 mm: 14 mm (59 mm),
 - \varnothing 8.01 - 10.00 mm: 18 mm (63 mm).
- Size indication on the insulated handle.
- Also available in tungsten carbide and ceramic with an accuracy of \pm 0.001 mm.



Per piece

Diameter/mm	Price EUR
0.06- 0.09	29.30
0.10- 0.19	23.10
0.20- 0.29	21.10
0.30- 0.49	13.30
0.50- 0.99	12.80
1.00- 2.99	12.90
3.00- 5.99	16.90
6.00-10.00	23.10

Sets

Item No.	Diameter mm	Pieces	Price EUR
833.761	0.06 - 0.50	45	961.00
833.762	0.51 - 1.00	50	758.00
833.763	1.01 - 1.50	50	741.00
833.764	1.51 - 2.00	50	741.00
833.765	2.01 - 2.50	50	741.00
833.766	2.51 - 3.00	50	741.00
833.767	3.01 - 3.50	50	900.00
833.768	3.51 - 4.00	50	900.00
837.311	4.01 - 4.50	50	900.00
837.312	4.51 - 5.00	50	900.00
837.313	5.01 - 5.50	50	900.00
837.314	5.51 - 6.00	50	900.00
837.315	6.01 - 6.50	50	1,282.00
837.316	6.51 - 7.00	50	1,282.00
837.317	7.01 - 7.50	50	1,282.00
837.318	7.51 - 8.00	50	1,282.00
837.319	8.01 - 8.50	50	1,282.00
837.320	8.51 - 9.00	50	1,282.00
837.321	9.01 - 9.50	50	1,282.00
837.322	9.51 - 10.00	50	1,282.00



Select setting rings

Setting rings, manufactured according DIN 2250 form C, 1 to 4 mm.

The size is indicated on the ring to three decimal places.

For all gauges also measuring reports can be ordered.

SELECT/

NEW



830.001

Item No.	Size/mm	Price EUR
830.001	1	148.00
830.002	1.2	141.00
830.003	1.5	136.00
830.004	1.8	132.00
830.005	2	127.00
830.006	2.2	123.00
830.007	2.5	118.00
830.008	2.8	114.00
830.009	3	49.00
830.010	4	31.80

Setting rings

Setting rings, manufactured according to DIN 2250 form C, 1 to 315 mm.

The size is indicated on the ring to three decimal places, 3 to 38 mm setting rings are also available in tungsten carbide as are form B rings for pneumatic measuring tools.

Prices for intermediate and larger sizes are available on request.



Also sets with most common sizes available.

Size mm	Price EUR	Size mm	Price EUR	Size mm	Price EUR	Size mm	Price EUR	Size mm	Price EUR
1	210.00	18	41.00	43	61.00	80	122.00	165	350.00
1.2	210.00	19	42.00	44	62.00	82	128.00	170	375.00
1.5	210.00	20	43.00	45	63.00	84	134.00	175	400.00
1.8	210.00	21	44.00	46	64.00	85	137.00	180	425.00
2	210.00	22	44.00	47	66.00	86	147.00	185	450.00
2.2	210.00	23	44.00	48	67.00	88	149.00	190	475.00
2.5	210.00	24	45.00	49	71.00	90	153.00	195	500.00
2.8	210.00	25	46.00	50	71.00	92	159.00	200	525.00
3	167.00	26	47.00	52	73.00	94	168.00	210	552.00
3.5	38.90	27	47.00	54	78.00	95	172.00	220	579.00
4	38.00	28	48.00	55	80.00	96	177.00	230	606.00
4.5	38.00	29	48.00	56	82.00	98	180.00	240	633.00
5	37.20	30	49.00	58	84.00	100	183.00	250	704.00
6	37.20	31	50.00	60	86.00	105	193.00	260	732.00
7	37.20	32	50.00	62	89.00	110	201.00	270	761.00
8	37.20	33	51.00	64	96.00	115	211.00	280	789.00
9	37.20	34	51.00	65	98.00	120	220.00	290	818.00
10	37.20	35	52.00	66	100.00	125	229.00	300	847.00
11	37.20	36	52.00	68	102.00	130	238.00	310	880.00
12	38.00	37	53.00	70	104.00	135	247.00	315	893.00
13	38.90	38	54.00	72	108.00	140	256.00		
14	39.40	39	55.00	74	113.00	145	266.00		
15	39.70	40	56.00	75	115.00	150	275.00		
16	40.00	41	58.00	76	118.00	155	300.00		
17	41.00	42	59.00	78	120.00	160	325.00		

Intermediate sizes over 3 mm are also available

Measuring reports

For all gauges also measuring reports can be ordered.

- ① Inspection report (German) per gauge. Stating of product specifications, measured values after production, used traceable measuring devices, measuring inaccuracy and measuring date. A favourable choice when your quality system does not require traceable certificates.
- ② Traceable certificate (Dutch) with measuring reports of the ordered gauges. Besides stating of the measured values the extra assurance of an external inspection.

Taper gauges

To increase the already large capacity to transmit moments, some taper gauges are furnished with a lip which functions as catch lock.



832.539



832.560



832.540



832.561

Morse taper gauges

Indica- tion Morse	Without lip, DIN 229				With lip, DIN 230			
	Item No.	Price EUR	Item No.	Price EUR	Item No.	Price EUR	Item No.	Price EUR
	Plug:		Ring:		Plug:		Ring:	
0	832.531	63.00	832.532	155.00	832.552	92.00	832.553	247.00
1	832.533	67.00	832.534	155.00	832.554	94.00	832.555	243.00
2	832.535	75.00	832.536	151.00	832.556	104.00	832.557	238.00
3	832.537	87.00	832.538	178.00	832.558	129.00	832.559	279.00
4	832.539	111.00	832.540	221.00	832.560	159.00	832.561	352.00
5	832.541	165.00	832.542	305.00	832.562	222.00	832.563	476.00
6	832.543	219.00	832.544	484.00	832.564	327.00	832.565	780.00

Metric taper gauges

Indica- tion metric	Without lip, DIN 234				With lip, DIN 235			
	Item No.	Price EUR	Item No.	Price EUR	Item No.	Price EUR	Item No.	Price EUR
	Plug:		Ring:		Plug:		Ring:	
4	804.001	79.00	804.011	246.00	–	–	–	–
6	804.002	79.00	804.012	246.00	–	–	–	–
80	804.003	380.00	804.013	801.00	804.021	549.00	804.031	1,303.00
100	804.004	595.00	804.014	1,078.00	804.022	785.00	804.032	1,769.00
120	804.005	892.00	804.015	1,688.00	804.023	1,134.00	804.033	2,520.00

Short taper gauges

Indica- tion SK	Plug, DIN 2079		Ring, DIN 2080	
	Item No.	Price EUR	Item No.	Price EUR
30	832.568	139.00	832.569	225.00
40	832.570	170.00	832.571	294.00
50	832.572	240.00	832.573	488.00
60	832.574	484.00	832.575	829.00



832.568



832.571

Measuring mandrels

The cylinders are hollow and have four marks on the cylinder wall near the thread and numbered marks in successive distances of 90° on the face. The cylinder and the front face are ground and lapped. The hardness is (60 ± 2) HRc.

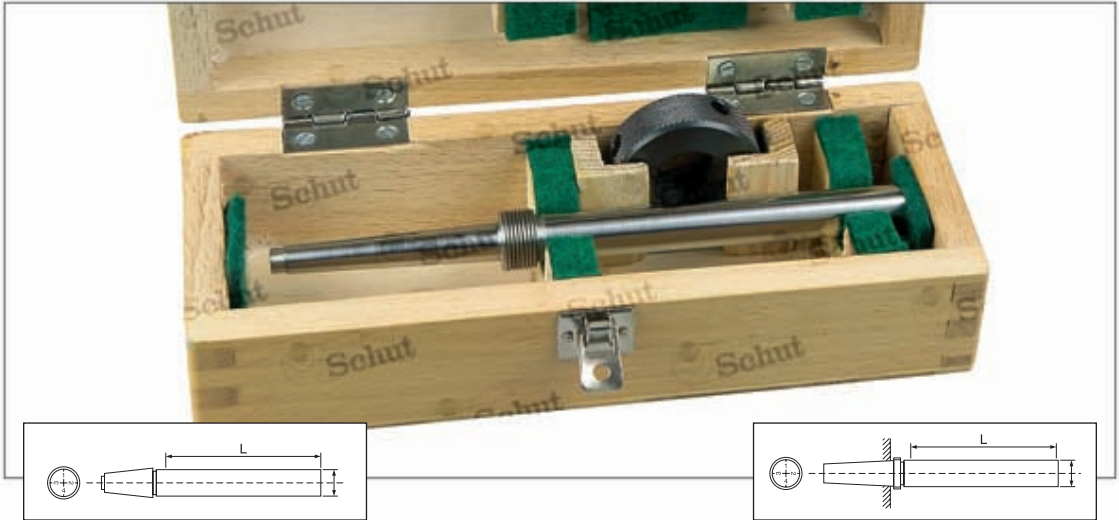

Measuring mandrels with internal thread, without external screw thread and nut

Item No.	Cone	Dimensions cylinder		Price
		ø/mm	length/mm	EUR
832.591	Sc 20	24	150	914.00
832.592	Sc 30	32	200	995.00
832.593	Sc 30	32	300	1,126.00
832.594	Sc 40	40	300	1,201.00
832.595	Sc 45	40	300	1,257.00
832.596	Sc 50	40	300	1,312.00
832.597	Sc 50	63	500	1,839.00

Specifications of the accuracy:

straightness of the cylinder $\leq 3 \mu\text{m}$, out of roundness $\leq 3 \mu\text{m}$, eccentricity $\leq 3 \mu\text{m}$.

Measuring mandrels without draw bar thread, with external screw thread and nut

Item No.	Cone	Dimensions cylinder		Price
		ø/mm	length/mm	EUR
832.581	Mc 0	12	75	561.00
832.582	Mc 1	12	75	583.00
832.583	Mc 2	24	150	895.00
832.584	Mc 3	32	200	1,010.00
832.585	Mc 4	40	300	1,257.00
832.586	Mc 5	40	300	1,349.00
832.587	Mc 6	63	500	1,875.00
832.588	Mec 80	80	500	2,100.00

Other models are available.

Gauges for keyway depths on shafts

- With interchangeable gauge parts.
- Available in all common fits.
- Prices available on request.



Thread gauges

The prices of the thread gauges apply to the following tolerances:

Kind of thread	Tolerances	
	Thread plug gauge	Thread ring gauge
Metric thread according ISO 1502 up to and incl. M1.4 larger than M1.4	5H 6H	6h 6g (standard) 4h and 6e
Fixing pipe thread DIN ISO 228	center	A
Trapezoidal thread DIN 103	7H	7e

Other tolerances, sizes and kinds of threads are available on request; also available are special screw threads as per your design. Left-hand screw thread: price on request.



Measuring reports

For all gauges also measuring reports can be ordered.

- ① Inspection report (German) per gauge. Stating of product specifications, measured values after production, used traceable measuring devices, measuring inaccuracy and measuring date. A favourable choice when your quality system does not require traceable certificates.
- ② Traceable certificate (Dutch) with measuring reports of the ordered gauges. Besides stating of the measured values the extra assurance of an external inspection.

Thread plug and ring gauges

Hardened steel thread plug gauges (up to M39: Go + NoGo, from M42: Go and NoGo separate) and thread ring gauges (Go or NoGo) for metric screw thread (ISO) with coarse pitch (ISO 1502).

Indication M...	Price EUR Thread plug	Price EUR Thread ring
1 x 0.25	156.00	111.00
1.2 x 0.25	142.00	102.00
1.4 x 0.3	129.00	94.00
1.6 x 0.35	124.00	85.00
1.8 x 0.35	108.00	73.00
2 x 0.4	108.00	75.00
2.2 x 0.45	97.00	63.00
2.5 x 0.45	93.00	57.00
3 x 0.5	50.00	41.00
3.5 x 0.6	48.00	38.20
4 x 0.7	46.00	37.30
4.5 x 0.75	46.00	37.30
5 x 0.8	45.00	37.30
6 x 1	44.00	37.30
8 x 1.25	45.00	38.20
10 x 1.5	48.00	44.00
12 x 1.75	52.00	52.00
14 x 2	56.00	57.00
16 x 2	59.00	63.00
18 x 2.5	64.00	72.00
20 x 2.5	69.00	80.00
22 x 2.5	73.00	87.00
24 x 3	82.00	93.00
27 x 3	91.00	104.00
30 x 3.5	100.00	114.00
33 x 3.5	110.00	124.00
36 x 4	119.00	134.00
39 x 4	131.00	146.00

Indication M...	Thread plug Go	Thread NoGo	Thread ring
42 x 4.5	79.00	71.00	158.00
45 x 4.5	85.00	77.00	168.00
48 x 5	92.00	84.00	177.00
52 x 5	99.00	89.00	191.00
56 x 5.5	109.00	99.00	204.00
60 x 5.5	116.00	105.00	218.00

Also most common sets available.



Thread plug and ring gauges (continued)

Hardened steel thread plug gauges (Go + NoGo) and thread ring gauges (Go or NoGo) for metric screw thread (ISO) with pitch 0.5 (ISO 1502).

Indication M... x 0.5	Price EUR Thread plug	Price EUR Thread ring
5	98.00	62.00
6	96.00	63.00
8	98.00	66.00
10	105.00	73.00
12	113.00	84.00
14	120.00	92.00
16	126.00	100.00
18	133.00	111.00
20	143.00	120.00



Hardened steel thread plug gauges (Go + NoGo) and thread ring gauges (Go or NoGo) for metric screw thread (ISO) with pitch 0.75 (ISO 1502).

Indication M... x 0.75	Price EUR Thread plug	Price EUR Thread ring
6	52.00	44.00
8	54.00	46.00
10	56.00	50.00
12	59.00	57.00
14	64.00	63.00
16	69.00	69.00
18	73.00	75.00
20	78.00	80.00
22	87.00	87.00
24	93.00	93.00
26	99.00	100.00
28	104.00	107.00
30	112.00	114.00

Hardened steel thread plug gauges (Go + NoGo) and thread ring gauges (Go or NoGo) for metric screw thread (ISO) with pitch 1 (ISO 1502).

Indication M... x 1	Price EUR Thread plug	Price EUR Thread ring
8	50.00	43.00
10	52.00	48.00
11	55.00	50.00
12	57.00	54.00
14	60.00	59.00
16	64.00	64.00
18	67.00	70.00
20	71.00	75.00
22	79.00	83.00
24	85.00	88.00
25	87.00	91.00
26	90.00	93.00
27	93.00	96.00
28	95.00	99.00
30	105.00	105.00



Hardened steel thread plug gauges (up to M40: Go + NoGo, from M42: Go and NoGo separate) and thread ring gauges (Go or NoGo) for metric screw thread (ISO) with pitch 1.5 (ISO 1502).

Indication M... x 1.5	Price EUR Thread plug	Price EUR Thread ring
12	52.00	53.00
14	55.00	57.00
16	58.00	62.00
18	61.00	67.00
20	65.00	73.00
22	72.00	78.00
24	77.00	83.00
25	79.00	86.00
26	82.00	89.00
27	84.00	91.00
28	87.00	93.00
30	95.00	99.00

(continued on the next page)

Thread plug and ring gauges (continued)

Indication M... x 1.5	Price EUR Thread plug	Price EUR Thread ring
<i>(continued)</i>		
32	96.00	105.00
33	99.00	107.00
34	101.00	110.00
35	103.00	112.00
36	105.00	114.00
38	114.00	121.00
39	115.00	123.00
40	121.00	127.00
Indication M... x 1.5	Thread plug Go NoGo	Thread ring
42	70.00 63.00	132.00
45	75.00 68.00	139.00
48	79.00 71.00	148.00
50	81.00 73.00	152.00

Hardened steel thread plug gauges (up to M40: Go + NoGo, from M42: Go and NoGo separate) and thread ring gauges (Go or NoGo) for metric screw thread (ISO) with pitch 2 (ISO 1502).

Indication M... x 2	Price EUR Thread plug	Price EUR Thread ring
20	65.00	73.00
22	72.00	78.00
24	77.00	83.00
26	82.00	89.00
28	87.00	93.00
30	95.00	99.00
32	96.00	105.00
34	101.00	110.00
36	105.00	114.00
38	114.00	121.00
40	121.00	127.00
Indication M... x 2	Thread plug Go NoGo	Thread ring
42	70.00 63.00	132.00
45	75.00 68.00	139.00
48	79.00 71.00	148.00
50	81.00 73.00	152.00



Hardened steel thread plug gauges (up to G1": Go + NoGo, from G1 1/8": Go and NoGo separate) and thread ring gauges (Go or NoGo) for non-sealing fixing pipe thread (DIN ISO 228).

Indication G..."	Price EUR Thread plug	Price EUR Thread ring
1/8	54.00	49.00
1/4	59.00	58.00
3/8	67.00	70.00
1/2	77.00	83.00
5/8	83.00	90.00
3/4	90.00	97.00
7/8	103.00	109.00
1	107.00	121.00
Indication G..."	Thread plug Go NoGo	Thread ring
1 1/8	71.00 65.00	137.00
1 1/4	75.00 67.00	151.00
1 1/2	87.00 79.00	170.00
1 3/4	98.00 89.00	189.00
2	108.00 99.00	208.00
2 1/4	118.00 107.00	224.00
2 1/2	137.00 124.00	256.00
2 3/4	149.00 135.00	277.00
3	161.00 145.00	300.00



Hardened steel thread plug and thread ring gauges for sealing pipe thread (DIN 2999).

Indication R..."	Price EUR Thread plug	Price EUR Thread ring
1/8	136.00	82.00
1/4	145.00	90.00
3/8	156.00	108.00
1/2	170.00	129.00
3/4	189.00	148.00
1	218.00	160.00
1 1/4	262.00	190.00
1 1/2	295.00	231.00
2	363.00	259.00

Larger sizes available on request

Thread plug and ring gauges (continued)

Hardened steel thread plug gauges (up to 1 1/4": Go + NoGo, from 1 3/8": Go and NoGo separate) and thread ring gauges (Go or NoGo) for American screw thread UNC and UNF according ANSI B 1.1 class 2B (thread plug) and 2A (thread ring).



Indication UNC	Price EUR Thread plug	Price EUR Thread ring
No 1-64	110.00	77.00
No 2-56	98.00	73.00
No 3-48	92.00	68.00
No 4-40	93.00	64.00
No 5-40	52.00	47.00
No 6-32	51.00	45.00
No 8-32	48.00	42.00
No 10-24	47.00	41.00
No 12-24	46.00	39.90
1/4 -20	45.00	39.90
5/16 -18	46.00	43.00
3/8 -16	48.00	45.00
7/16 -14	50.00	49.00
1/2 -13	54.00	55.00
9/16 -12	56.00	61.00
5/8 -11	59.00	67.00
3/4 -10	68.00	78.00
7/8 -9	77.00	90.00
1 -8	87.00	103.00
1 1/8 -7	97.00	114.00
1 1/4 -7	110.00	132.00

Indication UNC	Thread plug		Thread ring
	Go	NoGo	
1 3/8-6	67.00	60.00	147.00
1 1/2-6	74.00	67.00	157.00
1 3/4-5	89.00	80.00	183.00
2 -4 1/2	101.00	91.00	210.00
2 1/4-4 1/2	114.00	103.00	239.00
2 1/2-4	128.00	115.00	268.00
2 3/4-4	142.00	128.00	298.00
3 -4	154.00	140.00	325.00
3 1/4-4	168.00	152.00	356.00
3 1/2-4	181.00	165.00	384.00
3 3/4-4	195.00	176.00	412.00
4 -4	208.00	188.00	443.00

Indication UNF	Price EUR Thread plug	Price EUR Thread ring
No 0-80	124.00	92.00
No 1-72	107.00	77.00
No 2-64	98.00	72.00
No 3-56	96.00	68.00
No 4-48	93.00	63.00
No 5-44	52.00	47.00
No 6-40	51.00	45.00
No 8-36	48.00	42.00
No 10-32	47.00	41.00
No 12-28	47.00	39.90
1/4 -28	45.00	39.90
5/16 -24	46.00	43.00
3/8 -24	48.00	45.00
7/16 -20	50.00	49.00
1/2 -20	54.00	55.00
9/16 -18	56.00	61.00
5/8 -18	58.00	67.00
3/4 -16	64.00	78.00
7/8 -14	71.00	90.00
1 -12	79.00	103.00
1 1/8 -12	92.00	121.00
1 1/4 -12	97.00	132.00

Indication UNF	Thread plug		Thread ring
	Go	NoGo	
1 3/8 -12	60.00	54.00	147.00
1 1/2 -12	65.00	58.00	157.00

Hardened steel tapered thread plug and thread ring gauges for sealing pipe thread according ANSI/ASME B 1.20.1.



Indication NPT..."	Price EUR Thread plug	Price EUR Thread ring
1/16	132.00	188.00
1/8	136.00	193.00
1/4	145.00	203.00
3/8	156.00	214.00
1/2	170.00	232.00
3/4	189.00	255.00
1	218.00	289.00
1 1/4	262.00	338.00
1 1/2	295.00	373.00
2	363.00	454.00
2 1/2	413.00	521.00
3	504.00	667.00

Thread plug and ring gauges in sets

Sets of thread plug gauges or thread ring gauges for inspection of metric ISO threads.



836.561



836.562



- For threads M3, M4, M5, M6, M8, M10 and M12.
- Tolerance class:
thread plug gauges: 6H,
thread ring gauges: 6g.
- Hardened steel, thread plug gauges with aluminum grip.
- ISO 1502.
- Delivery in a wooden case with a traceable measuring report.



Item No.	Thread gauges set	Price EUR
836.561	Plug gauges (Go+NoGo)	245.00
836.562	Ring gauges (Go)	257.00
836.563	Ring gauges (NoGo)	257.00

Plug gauges and setting rings in sets

- Hardened steel, plug gauges with aluminum grip.
- Set setting rings DIN 2250 form C.
- Set plug gauges DIN 2248/2249.
- Delivery in a wooden case with a traceable measuring report.



Item No.	Description	Price EUR
836.564	Setting rings: $\phi 4$, $\phi 5$, $\phi 6$, $\phi 8$ mm	128.00
836.565	Setting rings: $\phi 10$, $\phi 12$, $\phi 16$, $\phi 20$, $\phi 25$ mm	165.00
836.566	Plug gauges (Go+NoGo) H7: 3, 4, 5, 6, 8, 10, 12 mm	148.00



Thread jaw gauges

Jaw-shaped gauge for inspection of external screw thread. Delivery excl. setting thread plug gauge.



Available on request.

Drill gauges

Gauge in the form of a steel plate with bores of increasing diameters for determining drill diameters.

- Increment: 0.1 mm.



836.640



Item No.	Measuring range/mm	Number of bores	Price EUR
836.640	0.1 - 10	100	87.00
836.641	3 - 10	71	66.00
856.545	15.1 - 17.5	25	121.00
856.546	17.6 - 20	25	147.00

Twist drill grinding gauges

For checking twist drills for the place and the 118° angle of the twist drill point. The maximum drill diameter is 50 mm.



856.441

Universal twist drill grinding gauge, also called *Y-gauge*. Besides the standard angle of 118°, this gauge also has a 90° angle for counter-sink drills, and some special angles for center drills.

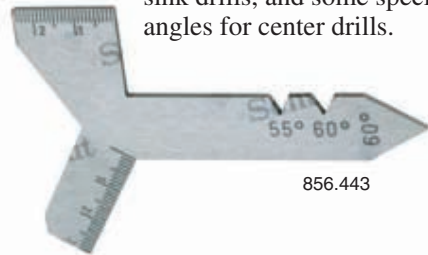

856.443

Item No.	Description	Price EUR
856.441	Twist drill grinding gauge	2.00
856.443	<i>Y-gauge</i>	3.50

Measuring wedges

Measuring wedges for quick measurements and checks of slits, key-ways, distances, etc.

- Measuring range: 0.4 - 26 mm.
- Graduation: 0.05, 0.1 or 0.2 mm.



909.537



909.535



909.536

Item No.	Measuring range/mm	Graduation mm	Price EUR
909.535	0.4- 6	0.05	48.00
909.536	1 - 15	0.1	42.00
909.537	2 - 26	0.2	17.80

Flat plug gauges

- Measuring range: 1 - 60 mm.
- Graduation: 0.1 mm.
- Stainless steel, no-glare chrome finished.
- Graduation on both sides.
- Ground measuring faces.



Item No.	Measuring range/mm	Price EUR
907.876	1 - 15	19.50
909.516	15 - 30	22.70
909.517	30 - 45	28.60
909.534	45 - 60	37.70



Conical plug gauges

- Measuring range: \varnothing 1 - 45 mm.
- Graduation: 0.1 mm.
- Hardened, ground and chrome finished.
- With anodized handle.



Item No.	Measuring range/mm	Price EUR
909.490	\varnothing 1 - 6	44.00
909.491	\varnothing 4 - 15	66.00
909.492	\varnothing 15 - 30	78.00
909.493	\varnothing 30 - 45	106.00



Nozzle gauges

Set of pins in holder serving as a gauge to determine jet nozzle sizes.



Item No.	Number of pins	Sizes mm	Price EUR
856.107	20	\varnothing 0.45 - 1.50	4.60
856.108	16	\varnothing 1.50 - 3.00	4.60
856.124	16	\varnothing 3.00 - 4.50	12.40
856.125	16	\varnothing 4.50 - 6.00	12.40

Nozzle gauges with vernier

Nozzle gauges with a hardened and ground tapered needle.

- Measuring range: \varnothing 0 - 5 mm.
- Vernier: 0.01 mm.



Item No.	Measuring range/mm	Price EUR
856.109	\varnothing 0 - 3	37.80
856.110	\varnothing 0 - 5	45.00

Center gauges

For checking thread cutting tools for Whitworth thread 55° or metric thread 60°.



856.444

Item No.	Description	Price EUR
856.444	Whitworth 55°	2.30
856.445	Metric 60°	2.30

Thread cutting tool gauges



856.446

Item No.	Description	Price EUR
856.446	Universal thread cutting tool gauge for angular thread and flat thread	3.40
856.447	Trapezoidal thread cutting tool gauge for trapezoidal thread DIN 103 (30°, 2-12 mm)	5.70
856.449	Combined lathe and thread cutting tool gauge for – cutting tool wedge angle, – trapezoidal thread DIN 103 (30°, 2-12 mm), and – angular thread (40° - 80°)	5.70
856.450	Combined lathe and thread cutting tool gauge like 856.449, with additional angle stop (0-30°) on the back	12.10
856.451	Thread cutting tool gauge for – rectangular thread, – trapezoidal thread DIN 103 (30°, 2-12 mm), and – angular thread (55° and 60°)	6.50



856.447



856.449



856.450



856.451

Angle gauge set

- Measuring range: 5 - 90°
(supplementary angles: 90 - 175°).
- Increment: 5° (18 pieces).
- Multiple angles per angle gauge:
 - primary angles (1, 2*, 3, 4),
 - supplementary angles (5, 6), and
 - ½ primary angles (7, 8).
- Delivery in a case.

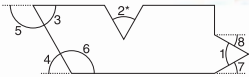

* Angle 2: only with the angle gauges from 20°.



Item No.	Description	Price EUR
909.410	Angle gauge set	24.40

Angle gauges

- Measuring range: 1 - 45°.
- Number of blades: 20.
- Angles: 1° - 2° - 3° - 4° - 5° - 6° - 7° - 8° - 9° - 10° - 12° - 14° - 16° - 18° - 20° - 25° - 30° - 35° - 40° - 45°.



Item No.	Description	Price EUR
908.798	Angle gauges	18.10

Radius gauges

- Measuring range radius: 1 - 25 mm.
- Increment:
 - 1 - 3 mm: 0.25 mm,
 - 3.5 - 20 mm: 0.5 mm,
 - > 20 mm: 1.0 mm.



Item No.	Radius range/mm	Price EUR
907.766	1 - 7	7.50
907.767	7.5 - 15	7.10
907.768	15.5 - 25	7.10

Shape and radius gauge

This stainless steel gauge can be used to adopt various complex shapes of tools and workpieces. When the gauge is pressed against the part which has to be checked, it takes on the shape of this part. Because of the graduation (mm) on the case, the shape can be checked easily.

Because the tracers were supported under pressure, they don't move on their own.



Item No.	Measuring range/mm	Price EUR
836.319	150 x 40	16.20

Set of welding seam gauges

- For weld thickness: 3 - 12 mm.
- Up to 7 mm increasing with 0.5 mm, plus 8, 10 and 12 mm.
- Total: 12 pieces.
- Bright steel.



Item No.	Description	Price EUR
856.452	Welding seam gauges	9.70

Welding seam gauge

For measurement of welding seams.

- Graduation: 0.2 mm.
- Stainless steel.
- Delivery in a case.



Item No.	Description	Price EUR
856.438	Welding seam gauge	41.00

Welding seam calipers

For measurement of welding seams.

- Measuring range: 0 - 20 mm.
- Analog: vernier 0.1 mm, digital: resolution 0.01 mm.
- Delivery in a case.

Analog

- Stainless construction.

Digital

- mm/inch conversion.
- On/off switch.
- Reset.
- Power supply: 1 battery type V357.

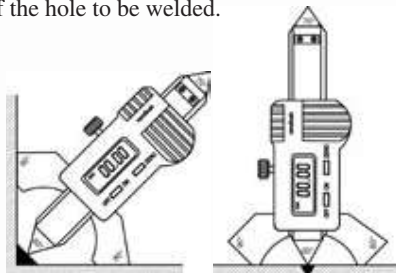
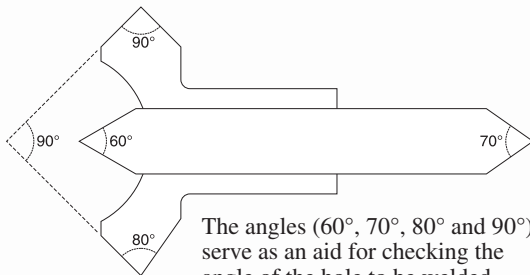
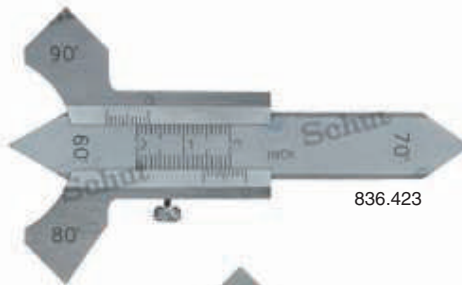

Item No.	Measuring range/mm	Price EUR
Analog: 836.423	0 - 20	14.00
Digital: 906.429	0 - 20	50.00
Option: 836.535 Spare battery		1.90

Thread and tolerance tables

Thread table

Table with all standard international thread indications: metric, Ww, Gas, BSF, Pg, BA, UNC, UNF and UNEF.

Tolerance table

Table comprising all tolerances and fits according ISO R286, up to 500 mm (table with over 6400 pairs of tolerance values for internal and external measurements).

Conversion table mm/inch

For converting from mm to inch and from inch to mm.



Item No.	Description	Price EUR
835.162	Thread table	39.90
835.163	Tolerance table	39.90
835.164	Conversion table mm/inch	39.90

Screw pitch gauges



Flat thickness gauge

Gauge to e.g. measure the thickness of steel plating.

- Measuring range: 1 - 13 mm.
- Graduation: 0.5 mm.
- Stainless steel.



Item No.	Measuring range/mm	Price EUR
907.899	1 - 13	6.40

Item No.	Type of thread	Price EUR
856.456	Metric	3.30
856.457	Whitworth	3.50
856.458	BSP	2.90
856.459	Metric/Whitworth	4.80
856.460	Metric/Whitworth BSP	5.90
856.461	UNC/UNF	4.40

Universal meter for bevels

Universal instrument for measurement of bevels from 0.5 to 10 mm. Direct reading of the measured bevel (30°, 45°, 60°).

- Measuring range: 30°: 15 mm,
45°: 10 mm,
60°: 5 mm.
- Hardened stainless steel construction.

- Delivery in a case.



Item No.	Description	Price EUR
838.727	Universal meter for bevels	394.00

**Magnifiers / Microscopes / Glass rulers / Stereo microscopes
Video microscopes / Endoscopes / Profile projectors**



Stand magnifier 5x

Standard, all-purpose magnifier.

- Dimensions:
ø 35 x 55 mm.



Item No.	Price EUR
905.110	8.60

Stand magnifier 10x

Standard, all-purpose magnifier. Very suitable for inspection of tissues, structures and photographic negatives.

- Dimensions:
ø 34 x 41 mm.



Item No.	Price EUR
905.112	13.50

Stand magnifier 10x

A simple, all-purpose magnifier.

- Dimensions:
ø 41 / ø 45 x 40 mm.



Item No.	Price EUR
905.316	7.20

Stand magnifier 15x

Bright images with high contrast due to a coated achromatic lens. With wide acrylic tube.

- Dimensions:
ø 27 / ø 36 x 33 mm.



Item No.	Price EUR
905.114	17.80

Stand magnifier 22x

Bright images with high contrast due to a coated achromatic lens. Suitable for inspection of high precision work.

- Dimensions:
ø 28 x 30 mm.



Item No.	Price EUR
905.116	36.20

Magnetic magnifier 5x

This magnifier has two small magnets which make sure that the magnifier can be put on a fixed position without moving. By placing this magnifier on hard to read scale divisions of, for example, graduated rulers, height gauges or micrometers, the possibility of reading errors substantially reduces.

- Field of view: \varnothing 30 mm.
- Dimensions: \varnothing 44 x 20 x 30 mm.
- Weight: 15 g.



Item No.	Description	Price EUR
905.210	Magnetic magnifier 5x	10.80

Eye magnifiers 3.3x ... 20x

Eye magnifiers can be placed in front of the eye easily, which makes them ideal tools for working on small products like watches, clocks and jewelry.

- Made of aluminum.
- Weight: 10 - 16 g.
- A small hole in the tube prevents the lens from becoming blurred.



905.390



905.394



905.301

Item No.	Type	Magnification	Lenses	Price EUR
905.390	A13D	3.3x	1	30.30
905.391	A16D	4.0x	1	30.30
905.392	A20D	5.0x	1	30.30
905.393	A26D	6.7x	1	30.30
905.394	A40D	10.0x	2	38.20
905.299	A48D	12.0x	1	56.00
905.300	A60D	15.0x	1	56.00
905.301	A80D	20.0x	1	56.00



Zoom magnifiers 8-16x and 10-20x

Unique stepless zoom lens with sufficient brightness in each stage of magnification and a minimum of optical aberration. With click-stop on magnifications 8/10/12/14/16x and 10/15/20x, respectively. Equipped with scale.

- Field of view: \varnothing 20 - 10 mm or \varnothing 13 - 7 mm.
- Graduation: 0.1 mm.



905.198

905.197

Item No.	Magnification	Field of view \varnothing /mm	Adjustment range eye correction	Measuring range/mm	Dimensions mm	Price EUR
905.197	8 - 16x	20 - 10	+2.5D to -5D	16	\varnothing 45 x 65	215.00
905.198	10 - 20x	13 - 7	+5D to -3.5D	12	\varnothing 42 x 52	235.00

Telecentric magnifier 7x

A telecentric magnifier shows objects, which are at different distances, with the same magnification. In this way 3D objects, or e.g. a needle above a scale, can be shown and measured accurately without parallax error.

- Field of view:
 \varnothing 24 mm.
- Measuring range
scale: 20 mm.
- Graduation: 0.1 mm.
- Adjustable diaphragm
with apertures \varnothing 0.5,
1 and 3 mm.
- Dimensions:
 \varnothing 38 x 74 mm.



Item No.	Description	Price EUR
905.136	Telecentric magnifier 7x including case and standard scale (for scales of \varnothing 26 mm)	145.00

Stand magnifier 4x

This practical and convenient magnifier can be used for many purposes, like inspecting films. The magnifier is delivered with a clear and a black base, which allows you, depending on the amount of light, to choose the base which is most suitable for your application.

- Field of view: \varnothing 45 mm.
- Dimensions: 51 x 51 x 65 mm.
- Weight: 80 g.



Item No.	Description	Price EUR
905.399	Stand magnifier 4x	61.00

Stand magnifier 8x

Convenient and smartly designed magnifier with achromatic lens. A scale is engraved at the bottom of the transparent acrylic base. Photographic negatives can be inspected using the base with opal glass.

- Field of view: 24 x 36 mm.
- Dimensions without base: 46 x 49 x 39 mm.
- Weight: 52 g.



Item No.	Description	Price EUR
905.290	Magnifier w/o base	34.20
905.291	Base	12.10

Light magnifier 3.5x

Large square lens (52 x 52 mm) of plastic with illumination, e.g. for reading maps and indicators, and for inspection of production processes.

- Dimensions: 60 x 75 x 190 mm.
- Weight (without batteries): 120 g.
- Power supply: 2 batteries type C.



Item No.	Description	Price EUR
905.212	Magnifier (w/o batteries)	30.30
495.153	Battery (2 needed)	1.10

Monocular telescopes

Lightweight pocket-size telescopes with erect image.

- Dimensions 905.207: \varnothing 22.5 x 50 mm,
905.208: \varnothing 22.5 x 53 mm.
- Weight: 32 g.
- Delivery in a case.



905.207

Item No.	Magnification	Lens aperture \varnothing /mm	Close focus distance/mm	Field of view (angle)	Field of view* \varnothing /mm	Field of view* \varnothing /m	Price EUR
905.207	2x	8	100	11°	12	192	183.00
905.208	4x	10	220	10°	29	175	183.00

* Field of view respectively at close focus distance and at 1000 m.

Head magnifiers 2.2x ... 5.2x

Because of the velcro strip, the head magnifier can be used easily. The great advantage of a head magnifier is that the user has both hands free for e.g. production and assembly of precision instruments. The head magnifier is designed in such a way that people who wear glasses can use it as well. With the extra pair of lenses inside the head magnifier, the magnification can be enhanced from 2.2x to 3.3x.

- Clear, broad and 3-dimensional view.
- Weight 905.318: 100 g,
905.317: 118 g.

905.318

905.317



Item No.	Magnification	Price EUR
905.318	2.2x / 3.3x	34.00
905.317	2.2x / 3.3x / 4.1x / 5.2x	43.00

Pen microscopes with EIM 25x ... 100x

These pen microscopes have a fixed scale and EIM system. With standard microscopes, the magnification is upside down, but because of the EIM system, this is not the case with these pen microscopes.

- Dimensions: $\varnothing 20.7 \times 111$ mm.
- Weight: 25 - 28 g.



905.404

Item No.	Magnification	Field of view \varnothing /mm	Measuring range/mm	Graduation mm	Price EUR
905.404	25x	3.50	3.0	0.05	161.00
905.405	50x	1.70	1.6	0.02	181.00
905.406	75x	1.10	1.0	0.01	200.00
905.407	100x	0.86	0.8	0.005	221.00



Pen microscopes 25x ... 100x

- Dimensions: $\varnothing 12.4 \times 127$ mm.
- Weight: 13 - 16 g.
- With a fixed scale (only 905.263/264).



905.267

Item No.	Magnification	Field of view \varnothing /mm	Measuring range/mm	Graduation mm	Price EUR
905.267	25x	3.30	—	—	40.00
905.268	50x	2.00	—	—	58.00
905.269	75x	1.09	—	—	65.00
905.266	100x	0.84	—	—	85.00
With fixed scale:					
905.263	25x	3.30	3.00	0.05	70.00
905.264	50x	2.00	1.60	0.02	82.00

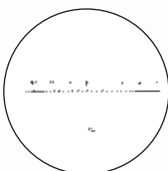

Light magnifiers 10x and 15x

Magnifier with illumination.

- Field of view: $\varnothing 25$ mm.
- Dimensions and weight (without batteries):
905.118: 175 x 35 x 41 mm, 81 g,
905.119: 180 x 36 x 42 mm, 90 g.
- Power supply: 2 batteries type C,
not included.



905.118

Folding magnifiers 7x ... 20x

Steinheil magnifiers with an excellent chromatic correction and a large field of view.

- Dimensions: 39 x 24 x 22 mm.
- Weight: 18 - 22 g.



905.202



Item No.	Magnification	Price EUR
905.118	10x	21.50
905.119	15x	36.80
495.153	Battery (2 needed)	1.10

Item No.	Magnification	Field of view \varnothing /mm	Price EUR
905.200	7x	16	46.00
905.202	10x	15.5	46.00
905.204	14x	12	46.00
905.206	20x	7	46.00

Folding magnifiers 3x ... 9x

Because of their small size, these folding magnifiers are easy to use. Available in several magnifications, with one or two lenses. The advantage of two lenses is that it gives a very sharp image, because the image error of the first lens is being corrected by the second one.

A mm scale is engraved at each of the four sides of the base. The scale length is equal to the width of the field of view (see table).



905.230



905.379

Item No.	Magnification	Field of view/mm	Number of lenses	Material/color	Price EUR
905.230	9x	10 x 10	1	Al/clear	10.80
905.375	7x	15 x 15	1	Al/clear	13.30
905.376	6x	25 x 25	1	Al/clear	15.70
905.377	9x	10 x 10	1	Al/black	11.70
905.378	7x	15 x 15	1	Al/black	14.50
905.379	6x	25 x 25	1	Al/black	17.40
905.383	4x	30 x 30	2	Al/black	68.00
905.384	3x	50 x 50	2	Al/black	76.00
905.380	9x	10 x 10	2	Zn/black	14.30
905.381	8x	15 x 15	2	Zn/black	16.60
905.382	6x	25 x 25	2	Zn/black	18.80

Scale magnifier 7x

All-purpose scale magnifier. Aberrations are avoided by the excellent achromatic lenses.

- Field of view: \varnothing 26 mm.
- Measuring range standard scale: 20 mm.
- Graduation: 0.1 mm.
- Dimensions: \varnothing 36 x 62 mm.
- Weight: 56 g.



Scale magnifier with illumination 905.138

- Field of view: \varnothing 22 mm.
- Dimensions: \varnothing 36 x 58 x 175 mm.
- Weight (without batteries): 118 g.
- Power supply: 2 batteries type C.

Item No.	Description	Price EUR
905.140	Magnifier with standard scale in a case	42.00
905.155	Set of magnifier 905.140 and five scales in a case	76.00
905.138	Magnifier 905.140 with illumination (without batteries)	61.00
495.153	Battery (2 needed)	1.10



Set 905.155

Scale magnifier 905.140 in a set with the five most frequently used scales (2, 3, 7, 8 and 10).

Scales \varnothing 26 mm

Aside from the standard scale, various other scales are available, each one with its own specific application. These scales are interchangeable in scale magnifiers like the one above.

Item No.	Scale	Price EUR
905.141	no. 1	10.20
905.142	no. 2	10.20
905.143	no. 3	10.20
905.144	no. 4	10.20
905.145	no. 5	10.20
905.146	no. 6	10.20
905.147	no. 7	10.20
905.148	no. 8	10.20
905.149	no. 9	10.20
905.150	no. 10	10.20
905.151	no. 11	10.20
905.152	no. 12	10.20
905.153	standard	10.20



905.141

905.142

905.143



905.144

905.145

905.146

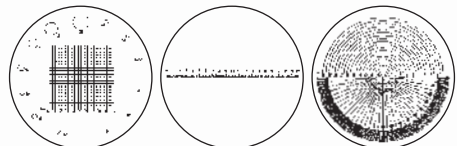

905.147

905.148

905.149

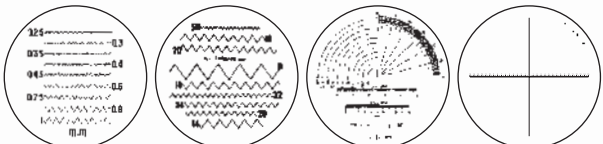

905.150

905.151

905.152

905.153

Scale magnifier 10x

All-purpose scale magnifier. Aberrations are avoided by the excellent achromatic lenses. High resolution and large field of view.

- Field of view: $\varnothing 35$ mm.
- Measuring range standard scale: 30 mm.
- Graduation: 0.1 mm.
- Dimensions: $\varnothing 46 \times 44$ mm.
- Weight: 74 g.



Scale magnifier with illumination 905.178

- Field of view: $\varnothing 32$ mm.
- Dimensions: $\varnothing 47 \times 45 \times 185$ mm.
- Weight (without batteries): 134 g.
- Power supply: 2 batteries type C.

Item No.	Description	Price EUR
905.180	Magnifier with standard scale in a case	58.00
905.195	Set of magnifier 905.180 and five scales in a case	108.00
905.178	Magnifier 905.180 with illumination (without batteries)	83.00
495.153	Battery (2 needed)	1.10



Set 905.195

Scale magnifier 905.180 in a set with the five most frequently used scales (2, 3, 7, 8 and 10).

Scales $\varnothing 35$ mm

Aside from the standard scale, various other scales are available, each one with its own specific application. These scales are interchangeable in scale magnifiers like the one above.

Item No.	Scale	Price EUR
905.181	standard	9.40
905.182	no. 1	11.10
905.183	no. 2	11.10
905.184	no. 3	11.10
905.185	no. 4	11.10
905.186	no. 5	11.10
905.187	no. 6	11.10
905.188	no. 7	11.10
905.189	no. 8	11.10
905.190	no. 9	11.10
905.191	no. 10	11.10
905.192	no. 11	11.10
905.193	no. 12	11.10

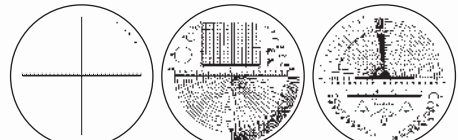

905.181

905.182

905.183

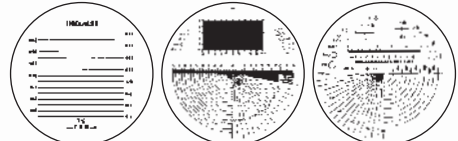

905.184

905.185

905.186

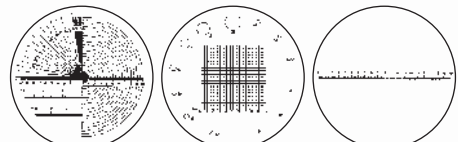

905.187

905.188

905.189

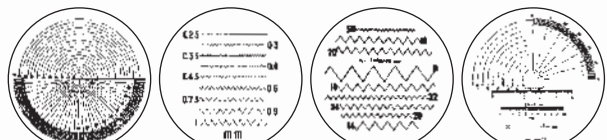

905.190

905.191

905.192

905.193

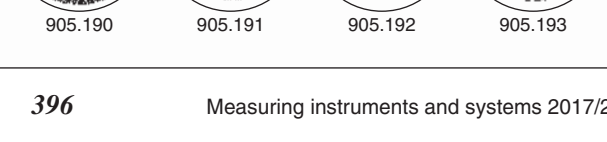

Long-distance microscope

The long-distance microscope consists of a stand microscope 40x (905.330) and an objective unit. The objects being inspected can be enlarged sharply at a short distance of 200 mm as well as at long distances. The microscope has a large field of view, and comes with a Huygens eyepiece (magnification 10x) and a detachable soft rubber eye adapter.

- Focusing with helicoid ring.
- Dimensions at working distance
200 mm: $\varnothing 46 \times 316$ mm,
infinite: $\varnothing 46 \times 262$ mm.
- Weight: 414 g.
- Delivery in a case incl. standard scale.



Item No.	Description	Price EUR
905.435	Long-distance microscope	626.00

Working distance/mm	Magnification	Field of view \varnothing /mm
200	27x	5.5
300	15x	10
400	10x	15
500	8x	19

Scale magnifier 3x

Scale magnifier with a lens system separated from the scale by a stand, hereby creating a larger working distance, field of view and luminous intensity. The scale is placed in a rotatable ring in the base of the stand.

- Field of view: $\varnothing 58$ mm.
- Measuring range scale: 54 mm.
- Graduation: 0.1 mm.
- Dimensions: 76 x 105 x 96 mm.
- Weight: 378 g.



Item No.	Description	Price EUR
905.328	Magnifier with scale and stand	171.00

Scale magnifier 30x

- Field of view: $\varnothing 7$ mm.
- Measuring range standard scale: 5 mm.
- Graduation: 0.05 mm.
- Dimensions: $\varnothing 30 \times 19$ mm.
- Weight: 16 g.



Scale magnifier with LED illumination 905.287

- Dimensions: $\varnothing 43 \times 65 \times 184$ mm.
- Weight (without batteries): 48 g.
- Power supply: 2 batteries type AAA.



Item No.	Description	Price EUR
905.285	Scale magnifier in case	76.00
905.287	Magnifier 905.285 with illumination (without batteries)	91.00
497.914	Battery (2 needed)	0.40
905.286	Separate standard scale	17.80

Anastigmatic scale magnifiers 4x and 7x

Magnifier with anastigmatic lens. This is a combined objective which reflects a large, undistorted image with sharp features, very suitable for inspection of (photographic) films.

- Large field of view, 905.216: $\varnothing 58$ mm,
905.400: $\varnothing 41$ mm.
- Removable scale with mm graduation.
- Measuring range scale 905.217: 54 mm,
905.401: 36 mm.
- Graduation scale: 0.1 mm.
- Dimensions and weight:
905.216: $\varnothing 73 \times 77$ mm, 272 g,
905.400: $\varnothing 55 \times 53$ mm, 103 g.



905.216

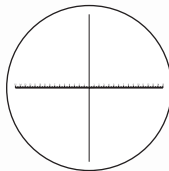

905.400

Item No.	Description	Price EUR
905.216	Scale magnifier 4x	168.00
905.400	Scale magnifier 7x	151.00
905.217	Standard scale for magnifier 905.216	35.80
905.401	Standard scale for magnifier 905.400	23.10

Scale magnifier 15x

- Field of view: $\varnothing 20$ mm.
- Measuring range standard scale: 14 mm.
- Graduation: 0.1 mm.
- Dimensions: $\varnothing 35 \times 33$ mm.
- Weight: 40 g.

NEW

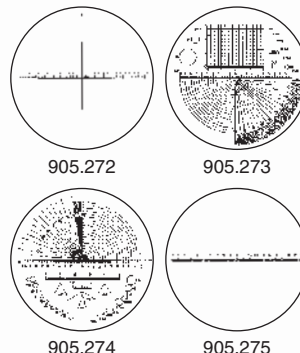

Item No.	Description	Price EUR
905.270	Magnifier with standard scale in a case	79.00
905.278	Magnifier 905.270 with illumination (without batteries)	100.00
497.914	Battery (2 needed)	0.40
905.272	Separate standard scale	16.20
905.273	Scale no. 1	16.20
905.274	Scale no. 2	16.20
905.275	Scale no. 8	16.20

Scale magnifier with LED illumination 905.278

- Dimensions: $\varnothing 43 \times 65 \times 184$ mm.
- Weight (without batteries): 72 g.
- Power supply: 2 batteries type AAA.



Stand magnifier 30x

This *microscopic* magnifier has a very high magnification despite its small size. In this way, the magnifier can be held with one hand, while you can hold the product to be inspected in the other. Because of the sophisticated optic design, this magnifier is almost comparable to a microscope of the same size, while the field of view is larger. This magnifier is often used in photo technique, for the production of precision instruments and for inspection of precision work.

- Lens aperture: $\varnothing 7$ mm.
- Dimensions: $\varnothing 37 \times 20$ mm.
- Weight: 10 g.



Stand magnifier with illumination 905.402

- Dimensions: $\varnothing 43 \times 65 \times 184$ mm.
- Weight (without batteries): 40 g.
- Power supply: 2 batteries type AA.

Item No.	Description	Price EUR
905.222	Stand magnifier $M=30x$	42.00
905.402	Stand magnifier 905.222 with illumination (without batteries)	59.00
495.111	Battery (2 needed)	0.40

ABC magnifier 3-18x

The ABC magnifier consists of three lenses. Combining the three lenses, seven different magnifications are possible.

- Magnification: 3x, 6x, 9x, 12x, 14x, 16x and 18x.
- Magnification and diameter of the lenses:
 - lens A: 12x, \varnothing 14 mm,
 - lens B: 3x, \varnothing 28 mm,
 - lens C: 6x, \varnothing 20 mm.
- Dimensions: 60 x 39 x 24 mm.
- Weight: 76 g.



Item No.	Description	Price EUR
905.196	ABC magnifier 3-18x	290.00

Magnifying glass 2.5-5x

This model of the classical magnifying glass has a lens-in-lens construction. In the big \varnothing 75 mm lens a smaller \varnothing 20 mm lens has been integrated which offers extra strong magnification. The big lens has a 2.5x magnification, the small lens 5x.

- Dimensions: \varnothing 80 x 170 mm.
- Weight: 111 g.



Item No.	Description	Price EUR
905.214	Magnifying glass 2.5-5x	29.40

Magnifier on magnetic stand

- Magnification: 2x (\varnothing 90 mm).
- Total length: 280 mm.
- Magnetic force: 600 N.



Item No.	Description	Price EUR
909.609	Magnifier on magnetic stand	20.50

Flexible stand magnifier

This magnifier has a flexible arm which can be adjusted freely from a solid and stabilized stand. The lens can be put in many positions for the most ergonomic use thus leaving both hands of the user free.

- Dimensions: 145 x 120 x 485 mm (maximum height).
- Weight: 1.5 kg.



905.279

Item No.	Magnification	Lens \varnothing /mm	Price EUR
905.279	1.7x	115	86.00
905.427	2.0x	100	77.00
905.428	2.2x	90	72.00

Stand microscopes 20x ... 300x

These stand microscopes are available in five versions. All five are compact and lightweight, but are especially characterized by their large field of view. Delivery in a case, including illumination, matching standard scale and objective. The microscopes come with a Huygens eyepiece (magnification 10x) and with a detachable soft rubber eye adapter. All-purpose use with high precision.

Type 2034

A scale graduation (with a 10 mm scale range) has been engraved on the focusing ring which allows height measurements at a resolution of 0.1 mm.

- Focusing with helicoid ring.
- Dimensions: $\varnothing 63 \times 172$ mm.
- Weight (without batteries): 237 - 241 g.
- Power supply: 2 batteries type AA.



Type 2034

Item No.	Magnification	Field of view \varnothing /mm	Working distance/mm	Measuring range/mm	Graduation mm	Price EUR
905.320	20x	7.2	36	6	0.1	261.00
905.330	40x	3.6	18.7	3	0.05	261.00
905.340	60x	2.4	10.8	2	0.02	282.00
905.350	100x	1.45	5.7	1.2	0.01	282.00
905.355	150x	0.96	9.2	0.9	0.005	342.00
905.370	200x	0.72	6.7	0.6	0.002	405.00
905.374	300x	0.48	4	0.4	0.001	514.00
Option: 495.111 Spare battery (2 needed)						0.40

Individual scales

The in the eyepiece integrated scale can be changed, for example when the magnification of the microscope changes (see "Individual objectives"). Additionally, an extra eyepiece (without scale and soft rubber eye adapter) is available, so the eyepiece doesn't need to be disassembled each time the scale is being changed.

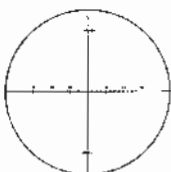

905.321

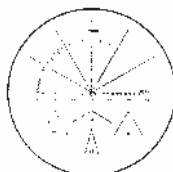

905.325

Item No.	Magnification microscope	Scale	Price EUR
Standard scales:			
905.321	20x	no. 54	37.00
905.331	40x	no. 64	37.00
905.341	60x	no. 74	37.00
905.351	100x	no. 84	37.00
905.356	150x	no. 94	37.00
905.337	200x	no. 104	37.00
905.388	300x	no. 114	37.00
For inspection of printed matter and tools:			
905.325	20x	no. 55	37.00
905.335	40x	no. 65	37.00
904.042	Individual eyepiece 10x		56.00

Stand microscopes 20x ... 300x (continued)

Types 2054/2054-EIM/2054-CIL/2064

These types primarily differ from the type 2034 in the focusing mechanism and the sturdy die-cast aluminum base.

- Focusing with rack-and-pinion.
- Dimensions: $\varnothing 63 \times 172$ mm.
- Weight (without batteries):
2054/2054-EIM: 263 - 267 g,
2054-CIL/2064: 393 - 394 g.
- Power supply:
2054/2054-EIM: 2 batteries type AA,
2054-CIL: 4 batteries type AA,
2064: 5 batteries type AA.



Type 2054-EIM

Erected Image with Measure (EIM)

With standard microscopes, the magnification is upside down, but this is not the case with the microscopes of type 2054-EIM.

Individual objectives

The objectives are also separately available. This gives you the great advantage that you can get all magnifications with one scale microscope. The magnification of the eyepiece is 10x.

Item No.	Magnification objective	Magnification microscope	Price EUR
905.322	2x	20x	77.00
905.332	4x	40x	77.00
905.342	6x	60x	88.00
905.352	10x	100x	88.00
905.357	15x	150x	125.00
905.372	20x	200x	185.00
905.387	30x	300x	241.00



Type 2054-CIL

Coaxial Incident Light (CIL)

The microscopes of the types 2054-CIL and 2064 are besides the standard illumination also provided with a coaxial light source, which is especially suitable for the inspection of objects with deep structures as well as chromed, high reflective surfaces. For the type 2064 this is a LED illumination.

Item No.	Magnification	Price EUR
Type 2054:		
905.410	20x	303.00
905.411	40x	303.00
905.412	60x	325.00
905.413	100x	325.00
905.414	150x	380.00
905.415	200x	448.00
905.416	300x	560.00
Type 2054-EIM:		
905.417	20x	356.00
905.418	40x	356.00
905.419	60x	380.00
905.420	100x	380.00
Type 2054-CIL:		Type 2064:
905.429	40x 728.00	905.293 695.00
905.430	60x 738.00	905.294 704.00
905.431	100x 738.00	905.295 704.00
905.432	150x 783.00	905.296 747.00
905.433	200x 871.00	905.297 831.00
905.434	300x 918.00	905.298 876.00
Option:		
495.111	Spare battery type AA	0.40

For other specifications: see table of type 2034.

Stand microscopes 25x ... 100x

Compact and light-weight stand microscope with scale. The high resolution and bright images as well as its easy focusing make this instrument a practical measuring aid. A scale graduation (scale range 8 mm) has been engraved on the focusing ring which allows height measurements at a resolution of 0.1 mm. With detachable soft rubber eye adapter. Delivery in a case, with matching standard scale.

- Dimensions: $\varnothing 41.5 \times 122$ mm.
- Weight: 83 g.

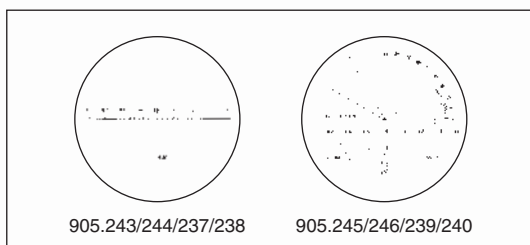

905.250

Item No.	Type	Magnification	Price EUR
Standard scales:			
905.243	24	25x	24.30
905.244	13	50x	24.30
905.237	34	75x	24.30
905.238	44	100x	37.00
Scales for inspection of printed matter and tools:			
905.245	25	25x	24.30
905.246	14	50x	24.30
905.239	35	75x	24.30
905.240	45	100x	37.00

Item No.	Magnification	Field of view \varnothing /mm	Working distance/mm	Measuring range/mm	Graduation mm	Price EUR
905.249	25x	3.3	17.0	3.0	0.05	136.00
905.250	50x	2.0	11.7	1.6	0.02	149.00
905.251	75x	1.1	11.7	1.0	0.01	158.00
905.258	100x	0.84	11.6	0.8	0.005	179.00

Glass rulers

- Graduation: 0.1 mm.
- Accuracy: ± 0.02 mm.
- Thickness: 10 mm.
- Width: 50 mm.
- Delivery incl. 2 magnifiers $M=10x$.
- Delivery in a case.



Item No.	Measuring range/mm	Length mm	Price EUR
905.422	0- 300	360	1,252.00
905.423	0- 500	560	1,878.00
905.424	0- 700	760	2,500.00
905.425	0-1000	1060	3,440.00

Special cleaner

Special cleaner (120 ml) for objectives, glass plates and other optical components.



Item No.	Description	Price EUR
111.534	Special cleaner	19.00

Field of view qualifier

- Accuracy: ± 0.002 mm.



Item No.	Description	Price EUR
635.222	Field of view qualifier	99.00

Optical cleaning kit

This cleaning kit is ideal to clean optics, microscopes and magnifying glasses, and can also be used on other products.

The set consists of:

- a bottle of cleaning solution (15 ml),
- a micro fiber cleaning cloth,
- a soft brush,
- an air blower.



Item No.	Description	Price EUR
909.432	Optical cleaning kit	6.20

Electronic scales with magnifier

This electronic scale with magnifier makes accurate and reliable measuring of flat products easier (e.g. printed material and metal sheets).

- Measuring range: 0- 1500 mm.
- Resolution: 0.01 mm.
- Repeatability: 0.01 mm.
- mm/inch conversion.
- RS232C data output.
- Reset.
- Fine adjustment.
- Hardened stainless steel construction.
- Magnifier: 10x magnification, crosshair scale with parallax control system (25x or 50x magnification available on request).
- Delivery in a case with an inspection report.
- Power supply: 1 battery type CR2032.



Item No.	Measuring range/mm	Accuracy mm	Price EUR
903.500	0- 180	±0.03	2,300.00
903.501	0- 300	±0.03	2,480.00
903.502	0- 500	±0.03	2,770.00
903.503	0- 800	±0.05	3,810.00
903.504	0- 1000	±0.05	4,530.00
903.505	0- 1300	±0.1	6,070.00
903.506	0- 1500	±0.15	7,660.00
Option:			
495.157	Spare battery		0.50

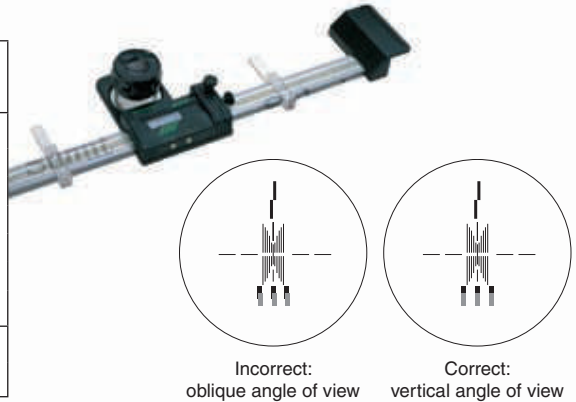

Electronic carbon scales with magnifier

- Measuring range: 0- 1450 mm.
- Resolution: 0.01 mm.
- Intake magnifier: $\varnothing 41$ mm.
- mm/inch conversion.
- Opto-RS232C data output.
- Reset/preset.
- Excl. magnifier (905.180); see “magnifiers” elsewhere in this catalog.
- Delivery in a case with an inspection report.
- Power supply: 1 battery type CR2032.



Item No.	Measuring range/mm	Accuracy mm	Length mm/A	Weight kg	Price EUR
838.715	0- 450	±0.03	720	1	1,020.00
838.716	0- 750	±0.03	1020	1.9	1,444.00
838.717	0- 1150	±0.05	1420	3	1,998.00
838.718	0- 1450	±0.06	1720	3.7	2,980.00
Options:					
495.157	Spare battery				0.50
905.180	Magnifier with standard scale 905.181				58.00
	Crosshair scale: horizontal 0.1 mm graduation (15 mm-0-15 mm)				
996.664	Holder for Dino-Lite USB measuring microscopes ¹				54.00



¹ See also “Dino-Lite USB video measuring microscopes” elsewhere in this catalog. For Dino-Lite Edge models with normal working distance; magnification approx. 30x.

Light magnifiers with fluorescent or LED illumination

Large lens with a large field of view. Very suitable for production and assembly of precision instruments.

- Magnification: 1.75x.
- Lens: \varnothing 120 mm
(909.649: \varnothing 100 mm).
- Span table clamp: 50 mm.
- Power supply: 230 V.



With circular fluorescent tube

Item No.	Description	Price EUR
909.650	With table clamp	70.00
909.651	With base	101.00
909.654	Spare bulb 22 W	7.80

With LED ring light

Item No.	Description	Price EUR
909.648	90 LEDs, with table clamp	112.00
909.649	60 LEDs, with base	62.00

Stereo microscope SSM

- Magnification: 20x.
- Field of view: \varnothing 9.5 mm.
- Viewing angle: 90°.
- Interpupillary distance: adjustable (55 - 75 mm).
- Working distance: 70 mm.
- Max. object height: 30 mm.
- Incident light (LED).



- Stage plate: white plastic, \varnothing 50 mm.
- Dimensions *l x w x h*: 135 x 120 x 230 mm.
- Power supply: 2 batteries type AA.

Item No.	Type	Magnification	Price EUR
909.012	SSM	20x	43.00
Option:			
495.111	Spare battery (2 needed)		0.40

Microscope SSM-1

- Magnification: 20x.
- Field of view: \varnothing 9.0 mm.
- Microscope head: 360° rotatable.
- Viewing angle: 45°.
- Working distance: 80 mm.
- Max. object height: 35 mm.
- Travel of the rack: 30 mm.

- Stage plate: black/white (two-sided), \varnothing 60 mm.
- Dimensions *l x w x h*: 195 x 110 x 245 mm.



Item No.	Type	Magnification	Price EUR
909.013	SSM-1	20x	52.00

Stereo microscopes SSM-2

Stereo microscopes on a column stand, with a sharp erect image and a large field of view. The magnification is 20x (eyepiece: 10x, objective: 2x); eyepieces 5x, 15x and 20x are optionally available. See for all accessories the pages “SSM stereo microscope accessories”.

- Viewing angle: 45°.
- Interpupillary distance: adjustable (55 - 75 mm).
- Left eyepiece with diopter adjustment: ± 5 dpt.
- Objective: with dovetail mounting.
- Stage plate: black/white (two-sided).
- Delivery incl. dust cover and soft rubber eye adapters.

Item No.	Type	Magnification	Price EUR
909.000	SSM-2A	20x	108.00
909.001	SSM-2C	20x	139.00

See for accessories the pages “SSM stereo microscope accessories”.



909.000



909.001

Type		SSM-2A	SSM-2C
Eyepiece	<i>M</i>	10x	10x
Objective	<i>M</i>	2x	2x
Total range*	<i>M</i>	10-40x	10-40x
Illumination		<i>no</i>	<i>yes</i>
Working distance	mm	70	70
Max. object height	mm	60	70
Travel of rack	mm	40	40
Stage plate	\varnothing /mm	60	95
Dimensions	<i>l</i> x <i>w</i> x <i>h</i> /mm	220x115x250	220x115x290
Weight	kg	1.6	2.6

*The magnification range of the microscope in combination with the optional eyepieces 5-20x.

Illumination: incident light and backlight

Model SSM-2C is equipped with incident light and backlight (switchable incident light or backlight).

- Stage plate: opal glass. Delivery incl. black/white stage plate. Dark field condenser optional.
- Power supply: 230 Vac (50 Hz).



Stereo zoom microscopes SSM-3/5

Stereo zoom microscopes with a sharp erect image and a large field of view. Equipped with a double objective (2x/4x is used most; also available 1x/2x and 1x/3x), so that the magnification can be changed with a simple rotary motion. The magnification of the eyepieces is 10x (optionally 5x, 15x and 20x). See for all accessories the pages “SSM stereo microscope accessories”.

- SSM-3: stand with round column.
SSM-5: fixed stand.
- Microscope head: 360° rotatable (only SSM-5).
- Viewing angle: 45°.
- Interpupillary distance: adjustable (55 - 75 mm).
- Left eyepiece with diopter adjustment: ±5 dpt.
- Stage plate: black/white (two-sided).
- Delivery incl. dust cover and soft rubber eye adapters.

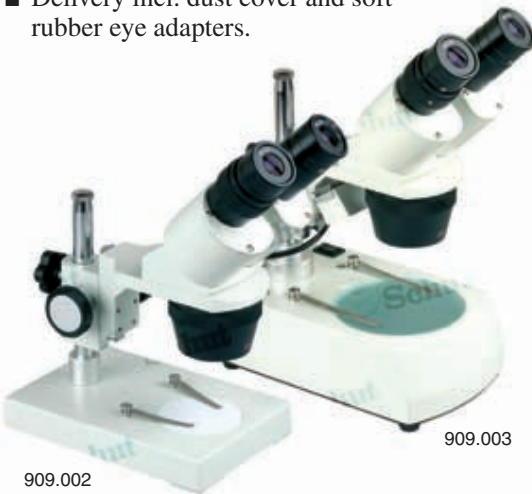

909.003

909.002

Illumination: incident light and backlight

Models SSM-3C/5CW are equipped with incident light and backlight (switchable incident light or backlight).

- Stage plate: opal glass. Delivery incl. black/white stage plate. Dark field condenser optional.
- Power supply: 230 Vac (50 Hz).

Item No.	Type	Magnification	Price EUR
909.002	SSM-3A	20x/40x	144.00
909.042	SSM-3A	10x/20x	144.00
909.032	SSM-3A	10x/30x	144.00
909.003	SSM-3C	20x/40x	161.00
909.043	SSM-3C	10x/20x	161.00
909.033	SSM-3C	10x/30x	161.00
909.034	SSM-5AW	20x/40x	137.00
909.044	SSM-5AW	10x/20x	137.00
909.004	SSM-5AW	10x/30x	137.00
909.005	SSM-5CW	20x/40x	183.00
909.045	SSM-5CW	10x/20x	183.00
909.035	SSM-5CW	10x/30x	183.00

See for accessories the pages “SSM stereo microscope accessories”.



909.004

909.005

Type		SSM-3A	SSM-3C	SSM-5AW	SSM-5CW
Eyepiece	M	10x	10x	10x	10x
Objective	M	2x/4x, 1x/2x or 1x/3x			
Total range*	M	10-80x, 5-40x or 5-60x			
Illumination		no	yes	no	yes
Working distance	mm	57	57	70	70
Max. object height	mm	60	70	20	20
Travel of rack	mm	40	40	30	20
Stage plate	ø/mm	60	95	60	95
Dimensions	l/wxh/mm	220x115x250	220x115x290	220x115x280	220x115x320
Weight	kg	1.7	2.6	1.7	2.5

*The magnification range of the microscope in combination with the optional eyepieces 5-20x.



Stereo zoom microscopes with auxiliary lenses SSM-10/20

Stereo zoom microscopes with a sharp erect image and a large field of view. Equipped with a double objective (2x/4x is used most; also available 1x/2x and 1x/3x), so that the magnification can be changed with a simple rotary motion. The magnification of the eyepieces is 10x (optionally 5x, 15x and 20x). The magnification can be adjusted to your application even more with an optional auxiliary lens (0.5x, 0.75x, 1.5x or 2x). See for all accessories the pages “SSM stereo microscope accessories”.

- SSM-10/20C2: stand with round (flattened) column and anti drop facility.
SSM-20W: fixed stand.
- Microscope head: 360° rotatable.
- Viewing angle: 45°.
- Interpupillary distance: adjustable (55 - 75 mm).
- Left eyepiece with diopter adjustment: ± 5 dpt.
- Working distance (without aux. lens): 72 mm.
- Stage plate: black/white (two-sided).
- Delivery incl. dust cover and soft rubber eye adapters.



909.006



Illumination: incident light and backlight

Models SSM-20C2/20W are equipped with incident light and backlight, and the luminous intensity is adjustable.

- Models SSM-20C2 are equipped with LED illumination.
- Stage plate: opal glass. Delivery incl. black/white stage plate. Dark field condenser optional.
- Power supply: 230 Vac (50 Hz).

Item No.	Type	Magnification	Price EUR
909.006	SSM-10	20x/40x	187.00
909.046	SSM-10	10x/20x	187.00
909.036	SSM-10	10x/30x	187.00
909.007 ¹	SSM-20C2	20x/40x	232.00
909.047 ¹	SSM-20C2	10x/20x	232.00
909.037 ¹	SSM-20C2	10x/30x	232.00
909.008	SSM-20W	20x/40x	222.00
909.048	SSM-20W	10x/20x	222.00
909.038	SSM-20W	10x/30x	222.00

¹ With LED illumination.

See for accessories the pages “SSM stereo microscope accessories”.



909.007

NEW

Type		SSM-10	SSM-20C2	SSM-20W
Eyepiece	M	10x	10x	10x
Objective	M	2x/4x, 1x/2x or 1x/3x		
Total range*	M	5-160x, 2½-80x or 2½-120x		
Illumination		no	yes	yes
Max. object height	mm	100	100	50
Travel of rack	mm	60	60	60
Stage plate	ø/mm	75	95	95
Dimensions	lwxh/mm	260x170x290	270x235x330	255x145x330
Weight	kg	3.0	4.3	4.0

* The magnification range of the microscope in combination with the optional eyepieces 5-20x and auxiliary lenses 0.5-2x.



909.008

Stereo microscopes with stepless zoom SSM-E

Stereo zoom microscopes with a sharp erect image and a large field of view. The special microscope head is equipped with stepless zoom; in combination with the standard 10x eyepieces (optionally 20x) you can smoothly zoom in from 10x to 40x magnification. The magnification can be adjusted to your application even more with an optional auxiliary lens (0.5x, 0.75x, 1.5x or 2x). See for all accessories the pages "SSM stereo microscope accessories".

- SSM-EW: fixed stand. SSM-EC2/3E/3EC2: stand with round (flattened) column and anti drop facility.
- Microscope head: 360° rotatable.
- Viewing angle: 45°.
- Interpupillary distance: adjustable (55 - 75 mm).
- Both eyepieces with diopter adjustment: ± 5 dpt.
- Working distance (without aux. lens): 85 mm.
- Equipped with incident light and backlight, and the luminous intensity is adjustable.
- Stage plate: opal glass.
- Delivery incl. dust cover, soft rubber eye adapters and black/white stage plate. Dark field condenser optional.

- Models SSM-EC2/3EC2 are equipped with **LED** illumination.
- Power supply: 230 Vac (50 Hz).

Item No.	Type	Magnification	Price EUR
909.009	SSM-EW	10 - 40x	374.00
909.010 ¹	SSM-EC2	10 - 40x	394.00
909.011	SSM-3E	10 - 40x	446.00
908.998 ¹	SSM-3EC2	10 - 40x	446.00

¹ With LED illumination.

See for accessories the pages "SSM stereo microscope accessories".

PRICE

 Schut



Type		SSM-EW	SSM-EC2	SSM-3E	SSM-3EC2
Eyepiece	M	10x	10x	10x	10x
Objective	M	1-4x	1-4x	1-4x	1-4x
Total range*	M	5-160x	5-160x	5-160x	5-160x
Illumination		yes	yes	yes	yes
Max. object height	mm	50	110	110	110
Travel of rack	mm	60	60	60	60
Stage plate	ø/mm	95	95	95	95
Dimensions	lwxh/mm	310x150x360	330x235x360	330x150x395	330x235x395
Weight	kg	4.5	4.8	5.1	5.4

*The magnification range of the microscope in combination with the 10x eyepieces, the optional 20x eyepieces and the optional auxiliary lenses 0.5-2x.

NEW

Camera connection

Models SSM-3E and 3EC2 are equipped with camera connection. See the accessories page for the total magnification range with camera.

SSM stereo microscope accessories

USB microscope cameras

For viewing and saving images. They fit in the ocular ($\varnothing 30$ mm) of an SSM microscope and/or the adapter bushing ($\varnothing 23$ mm) of the models SSM-3E/3EC2.

- Field of view: see table.
- Resolution: 1.3 Mpx or 5 Mpx.
- Suitable for Windows and Mac OS X.
- Measuring of distances, radii and angles.



Auxiliary lenses

The magnification can be adjusted to your application even more with an optional auxiliary lens. Note concerning stereo microscopes with a fixed stand: auxiliary lens 0.5x is not suitable, and with auxiliary lenses 1.5x and 2x focusing on the stage plate is not possible (the product needs to be positioned higher).



Item No.	Description	Price EUR
Pairs of eyepieces for SSM-2/3/5/10/20:		
909.050	M=5x	44.00
909.051	M=10x	31.10
909.052	M=15x	38.90
909.053	M=20x	36.30
Pairs of eyepieces for SSM-E:		
909.055	M=10x	38.90
909.057	M=20x	65.00
Eyepieces with crosshair for SSM-E:		
909.095	M=10x (per piece)	47.00
909.096	M=20x (per piece)	47.00
Auxiliary lenses (for SSM-10/20/E):		
909.018	M=0.5x	46.00
909.019	M=0.75x	46.00
909.020	M=1.5x	46.00
909.021	M=2x	54.00
USB microscope cameras:		
774.145	1.3 Mpx, $\varnothing 23$ mm	189.00
774.146	1.3 Mpx, $\varnothing 23/30/30.5$ mm	209.00
774.147*	5 Mpx, $\varnothing 23$ mm	349.00
774.148*	5 Mpx, $\varnothing 30/30.5$ mm	369.00

*For displaying the 5 Mpx resolution a Motion JPEG codec is required.



Magnification objective	Microscope magnification / Field of view/mm			
	Eyepiece 5x	Eyepiece 10x	Eyepiece 15x	Eyepiece 20x
Stereo microscope SSM-2:				
2x	10x / $\varnothing 10.0$	20x / $\varnothing 10.0$	30x / $\varnothing 7.5$	40x / $\varnothing 6.5$
Stereo zoom microscope SSM-3/5:				
1x	5x / $\varnothing 20.0$	10x / $\varnothing 20.0$	15x / $\varnothing 15.0$	20x / $\varnothing 9.5$
2x	10x / $\varnothing 10.0$	20x / $\varnothing 10.0$	30x / $\varnothing 7.5$	40x / $\varnothing 4.6$
3x	15x / $\varnothing 7.0$	30x / $\varnothing 6.7$	45x / $\varnothing 5.0$	60x / $\varnothing 3.1$
4x	20x / $\varnothing 5.0$	40x / $\varnothing 5.0$	60x / $\varnothing 3.7$	80x / $\varnothing 2.3$
Stereo zoom microscope SSM-10/20 (without auxiliary lens):				
1x	5x / $\varnothing 20.0$	10x / $\varnothing 20.0$	15x / $\varnothing 15.0$	20x / $\varnothing 10.0$
2x	10x / $\varnothing 10.0$	20x / $\varnothing 10.0$	30x / $\varnothing 7.5$	40x / $\varnothing 4.9$
3x	15x / $\varnothing 7.0$	30x / $\varnothing 7.0$	45x / $\varnothing 5.0$	60x / $\varnothing 3.2$
4x	20x / $\varnothing 5.0$	40x / $\varnothing 5.0$	60x / $\varnothing 3.8$	80x / $\varnothing 2.5$

Pairs of eyepieces



Soft rubber eye adapters

Item No.	Description	Price EUR
909.089	Per pair	4.20



Magnification objective	Magnification / Field of view/mm		Field of view camera/mm			
	Eyepiece 10x	Eyepiece 20x	774.145	774.146	774.147	774.148
Stereo microscope with stepless zoom SSM-E (without auxiliary lens):						
from 1x to 4x	10x / $\varnothing 23.0$ 40x / $\varnothing 5.5$	20x / $\varnothing 10.5$ 80x / $\varnothing 3.0$	4.5 x 3.3 ¹ 1.2 x 0.8 ¹	6.8 x 5.0 ¹ 1.4 x 1.0 ¹	4.5 x 3.3 ¹ 1.2 x 0.9 ¹	
from 1x to 4x				5.6 x 4.1 ² 1.34 x 1.0 ²		4.9 x 3.5 ² 1.25 x 0.9 ²

¹Camera intake in adapter bushing. ² Camera intake in ocular.



SSM stereo microscope accessories (continued)

Halogen optical fiber illumination

Halogen optical fiber ring light^{1,2}

Suitable for stereo microscopes SSM-10/20/E.
Note: not for use in combination with auxiliary lenses.

Ring lights^{1,2}

Suitable for SSM-10/20/E (909.085) or SSM-3/5/10/20/E (909.024).

Dark field condenser

The contrast of transparent objects is enhanced. Suitable for all SSM stereo microscopes with backlight.

- Diameter: 94 mm.
- Stage: \varnothing 27 mm.



XY measuring table

- Range: X, Y: 25 mm.
- Intake microscope: \varnothing 94 mm.
- Turnable object plate with degree indication.
- Excl. two analog micrometer heads (intake \varnothing 12 mm; 906.072 measuring range 25 mm).



Item No.	Description	Price EUR
Halogen optical fiber illumination:		
909.027	Light source 24 V, 150 W	178.00
909.030	Single flexible arm	98.00
909.028	Dual flexible arm	146.00
909.029	Optical fiber ring light ^{1,2}	251.00
909.113	Spare bulb for 909.027	10.90
Ring lights^{1,2}:		
909.024	Circular fluoresc. tube 10 W	38.90
909.059	Spare bulb for 909.024	7.30
909.085	Ring light 60 LEDs	109.00
Spare bulbs (standard illumination):		
499.377	For SSM-2/3/5	1.50
498.157	For SSM-20W/EW, and for transmitted light SSM-20C2/EC2/3E	7.00
499.379	For incident light SSM-20C2/EC2/3E	4.10
438.211	Fuse F 0.5 A, 250 V	0.50
Other options:		
909.022	Dark field condenser	47.00
908.999	XY measuring table	501.00
960.255	Dial indicator holder	42.00
635.222	Field of view qualifier	99.00

¹ Delivery incl. adapter ring.

² Note: microscopes with standard provided incident light, this incident light must be removed before installing the ring light.

Dial indicator holder

Suitable for stereo microscopes with round column from the series SSM-10/20/E, for height measurements. The accuracy increases with higher magnification.

- Excl. dial indicator.
- The travel of the microscopes is 60 mm; see the dial indicators category for a suitable dial indicator with measuring range 50 or 60 mm.



Field of view qualifier

- Accuracy: ± 0.002 mm.

635.222



SSM stereo microscope accessories (continued)

Large stand

- Base: 255 x 255 mm.
- Column height: 390 mm.
- Arm length: 490 mm.
- Height adjustment: 60 mm.

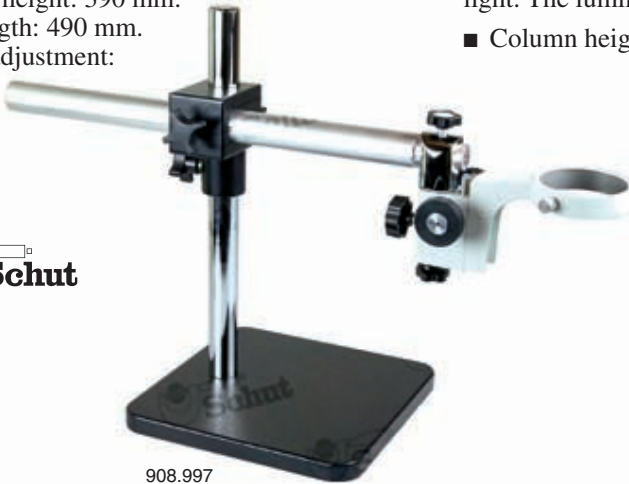

908.997

Stand with illumination

Equipped with LED incident light and back-light. The luminous intensity is adjustable.

- Column height: 185 mm.



909.405

LCD microscope head

- Screen: 8" color.
- CCD: 1/3" color.
- Zoom lens: 0.65 - 5.5.
- Magnification: 10 - 85x.
- Working distance: 10.5 cm.
- Crosshair can be toggled on/off.
- Field of view: from 1.3 x 1.8 mm ($M=85x$) to 12 x 16 mm ($M=10x$).



909.405
+909.406
+870.006
+334.695



909.406

Microscope heads

- With or without camera connection.



909.093



Item No.	Description	Price EUR
Microscope stands:		
908.997	Large stand	205.00
909.405	Stand with illumination	105.00
870.006 ¹	Column 400 mm	26.00
Microscope heads:		
909.092	Microscope head	332.00
909.093	Microscope head with camera connection	384.00
909.406 ²	LCD microscope head	959.00
334.695	Mini AC adapter 12 Vdc, 1 A	29.00

¹ To be used with stand 909.405 for a larger Z axis range.

² Adapter 334.695 required.

Dino-Lite USB video measuring microscopes

Very versatile and compact digital microscopes with measuring functions for various medical, industrial and educational applications. Optical product inspection can even be performed around your production machine; thanks to the stepless magnification and LED illumination you can display your products very sharply on the screen. Images can be saved as a picture or video file. Geometrical forms, such as distances, radius and angles can be measured.

- Magnification: stepless or fixed.
- Resolution: 1.3 Mpx (1280 x 1024 px) or 5 Mpx (2592 x 1944 px).
- Illumination: 8 LED white ring light.
- With software for Windows and Mac OS X (limited support under Mac OS X).
- Measuring and calibration function and edge detection.
- Plastic or aluminum housing.
- Dimensions: $\varnothing 32 \times 120$ mm.
- Connection and power supply: USB 2.0 cable (1.8 m).

Also available:

- models with magnification up to 900x or coaxial light,
- with PAL, VGA or DVI connection for live images on TV screen, monitor or beamer,
- with special illumination by near-UV, near-IR, fluorescent or stroboscopic LEDs,
- mobile models with portable 5" screen,
- WiFi Streamer for a wireless connection with a tablet or a smartphone,
- ESD-safe models available,
- USB 3.0 models with a higher frame rate,
- models with extra long working distance for a large field of view.

NEW



Download the
brochure from
Schut.com

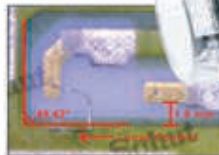

774.228



Item No.	774.081	774.129	774.088	774.106	774.024 ¹	774.028 ¹	774.216 ¹	774.228 ¹	774.229 ¹
Price EUR	274.00	570.00	339.00	514.00	539.00	709.00	799.00	999.00	999.00
Magnification (stepless)	10-70x	10-70x	10-70x	10-90x	10-140x	10-140x	10-140x	10-220x	10-140x
Magnification (fixed)	200x	200x	200x	–	–	–	–	–	–
Resolution px	1.3 M	5 M	1.3 M	1.3 M	1.3 M	1.3 M	5 M	5 M	5 M
FLC ²	–	–	–	–	–	–	✓	✓	✓
EDOF/EDR ³	–	–	–	–	–	✓	–	✓	✓
AMR ⁴	–	–	–	–	–	–	–	✓	✓
Polarizer	–	–	✓	✓	✓	✓	✓	✓	✓
Long working distance	–	–	–	✓	✓	✓	✓	–	✓
Removable front	–	–	–	–	✓	✓	✓	✓	✓
Aluminum housing	–	✓	–	✓	–	–	✓	✓	✓
Weight g	105	140	105	140	105	105	125	137	137

¹ New Edge generation with better optics and exchangeable front sides.

² FLC: Flexible Light Control.

³ EDOF: Extended Depth of Field / EDR: Extended Dynamic Range.

⁴ AMR: Auto-Magnification Read.

Dino-Lite USB video measuring microscope accessories

Stable positioning is required for sharp pictures and accurate measurements. The measuring microscopes can be positioned stably with a microscope stand.



Item No.	Description	Price EUR
Microscope stands¹:		
774.108 ²	Stand with height fine adjustment (15 mm) and flexible arm	49.00
774.116	Table clamp (span 3 cm) with flexible arm	49.00
774.093 ⁶	Stand	99.00
774.093 ⁶	Stand with pivoting arm	129.00
774.115	Flexible arm for 774.093/095	49.00
774.026	High precision aluminium stand	259.00
774.117	Heavy-duty stand with table clamp and jointed arm	303.00
774.118	Heavy-duty stand with base and jointed arm	361.00
774.144	Stand, small model	79.00
Microscope holders:		
774.092	Transparent table model	29.50
774.155 ¹	Holder for mounting on a microscope stand	12.50
996.390 ³	Reducing coupling \varnothing 10/8 mm	6.90
Other options:		
774.130	Rolling stand	99.00
774.091 ⁴	Mirror 45°	49.00
774.094	XY table	149.00
774.100 ⁵	Polarized backlight stage	219.00
774.120 ⁵	Polarized LED illumination	37.00
774.060	Ring Light Cap for Dino-Lite Edge	79.00
419.030	USB extension cable (3 m)	5.70
774.121	USB foot switch	50.00
774.122	Robust case (IP67)	28.00

¹ All microscope stands are delivered with holder 774.155, except microscope stand 774.108.
² To use measuring microscope stand 774.108 in combination with measuring microscopes with polarizer the holder 774.155 shall be ordered separately.
³ For mounting holder 774.155 on a dial indicator stand.
⁴ For use with long working distance microscopes with removable front.
⁵ More suitable in combination with the measuring microscopes with polarizer.
⁶ ESD-safe models available.

Endoscopes

Endoscopes for inspecting hard-to-reach places by means of a flexible cable. Equipped with built-in illumination. Delivery in a case.

Endoscopes GSI

- Resolution: 7400 px.
- Soft flexible cable ø4 mm, or rigid bendable cable ø8 mm.
- Field of view: 40°.
- Viewing distance: 3 mm to infinite (depends on ambient light).
- Xenon halogen illumination.
- Power supply: 2 batteries type AA.

USB endoscope GSIV

- Camera resolution: 1.3 Mpx.
- Rigid bendable cable ø9 mm.
- Field of view: 67°.
- Viewing distance: 2- 10 cm.
- Illumination: 6 LEDs (intensity adjustable).
- Delivery with software (English) for Windows 2000/XP and USB cable.
- Power supply: via USB.

Portable monitoring endoscopes GSIM

With control panel (English) for taking and saving pictures and video.

- Camera resolution: 320 x 240 px.
- Resolution: 640 x 480 px (JPEG pictures), 320 x 240 px (ASF video).
- 3.5" TFT LCD monitor 320 x 240 px.
- Soft flexible cable ø5.5 mm.
- Field of view: 67°.
- Viewing distance: 1.5- 10 cm.
- Illumination: 4 LEDs (intensity adjustable).
- Memory card: SD 4 GB.
- USB connection for data transfer to PC.
- Delivery with USB cable, video cable, memory card SD 1 GB and adapter 5.5 V.
- Power supply: 1 rechargeable battery 3.7 V.

Portable monitoring endoscope ZE

- Camera resolution: 640 x 480 px.
- 2.5" TFT LCD monitor 320 x 240 px.
- Rigid bendable cable ø7 mm. Camera: ø10 mm.
- Field of view: 53°.
- Viewing distance: 8- 2000 cm
- Illumination: 6 LEDs (intensity adjustable).
- Power supply: 4 batteries type AA.



Item No.	Type	Cable ø/mm	Cable length/cm	Price EUR
909.270	GSI-4	4	40	370.00
909.271	GSI-8	8	40	331.00
909.272	GSIV	9	40	1,056.00
909.273	GSIM	5.5	100	1,337.00
909.296	GSIM	5.5	200	1,406.00
909.299	GSIM	5.5	300	1,520.00
909.334	ZE	7	100	446.00

Options:		Options for GSIV:	
495.111	Spare battery for GSI/ZE (2 or 4 needed)	0.40	
909.277	Xenon bulb for GSI	13.00	
909.289	Mirror 35°	42.00	
909.282	Mirror 45°	42.00	
909.288	Mirror 55°	42.00	
909.283	Magnet	42.00	

Options for GSI-4:		Options for GSIM:	
909.278	Mirror 35°	42.00	
909.274	Mirror 45°	42.00	
909.275	Mirror 55°	42.00	
909.291	Mirror 35°	42.00	
909.284	Mirror 45°	42.00	
909.290	Mirror 55°	42.00	

Options for GSI-8:		Options for ZE:	
909.287	Mirror 35°	42.00	
909.280	Mirror 45°	42.00	
909.286	Mirror 55°	42.00	
909.281	Magnet	42.00	
909.335	Mirror 35°	42.00	
909.336	Mirror 45°	42.00	
909.337	Mirror 55°	42.00	
909.338	Magnet	42.00	
909.339	Hook	20.80	



Mitutoyo profile projectors PJ-A3000

Convenient and multifunctional profile projector for measurements on small and medium sized objects. Standard equipped with halogen surface and contour illumination and a 10x projection lens. The rotatable screen with an effective diameter of 315 mm is provided with a digital protractor to eliminate the need to perform complex calculations. Easy to read digital counters located near the projection screen accurately display XY stage travel. Ergonomically placed hand wheels for normal table adjustments and 'free floating' quick adjustment for axes from 100 mm. Many optional accessories are available.

With the 2D processor QM-Data 200 you can turn the PJ-A3000 into a powerful 2D measuring system. Measuring programs and results are saved in its memory. Besides measuring circle, point, line, ellipse, rectangle, distance, intersection and angle you have additional analysis options like squareness and parallelism. Also contains an AI (Artificial Intelligence) function, which determines the type of element based on the received measuring data.

- Measuring range: 150 x 50 or 200 x 100 mm.
- Resolution: 0.001 mm.
- ABS/INC switchable.
- RS232C data output.
- Reset.
- Reversible measuring direction.
- Built-in bevel protractor:
measuring range: $\pm 360^\circ$,
resolution: $0^\circ 1' / 0.01^\circ$ switchable.
- Max. deviation of the enlargement:
0.1% with contour illumination,
0.15% with surface illumination.
- Dimensions: 741 x 1093 x 400 mm.
- Measuring table:
PJ-A3005: 280 x 152 mm,
PJ-A3010: 380 x 250 mm.
- Max. workpiece height:
PJ-A3005: 103.5 mm,
PJ-A3010: 92.5 mm.
- Illumination:
halogen bulb 24 V, 150 W.
- Weight:
PJ-A3005: 116 kg,
PJ-A3010: 140 kg.
- Standard accessories:
 - projection lens 10x,
 - dust cover,
 - masking shield,
 - 3 halogen bulbs (24 V, 150 W).



Item No.	Type	Measuring range/mm	Price EUR
302.702	PJ-A3005 F-150	150 x 50	
302.701	PJ-A3010 F-200	200 x 100	
Options:			
264.156	QM-Data 200		
120.807	Cable QM-Data		
512.305	Halogen bulb 24 V, 150 W		
111.534	Special cleaner for optical components		

Fixture system for measuring microscopes

DF is a fixture system developed and produced by Schut and designed for building product fixtures, particularly for optical measurements.

It is especially suited for the quick and easily fixing and positioning of small products, for instance by using an angle stop and spring clamp.

DF is very easy to mount with single-screw couplings to build fixtures with a high repeatability and to realize a short lead-time for measuring jobs.

DF consists of a full range of fixture components: bars, connection components and fixing components. DF is a universal fixture system and can be mounted on almost any type of microscope or measuring microscope.



See for more information the page “DF product fixture system”.

TESA Plastiform

These Plastiform-products allow print molding of complex internal forms, which can be measured and checked by e.g. video measuring machines, profile projectors or microscopes.

- Shrinking: < 1 µm/mm after removal of the mould.
- Working temperature: 20°C.
- Polymerization will not occur below 10°C.



The set consists of:

- 1 DS50 injection handle,
- 1 cutter, special with two parallel blades,
- 1 Plastin (200 g),
- 50 mixer-injectors,
- 10 injector end pieces,
- 1 DN1 spot remover (400 ml),
- 21 rings for mould removal,
- 3 Plastiform BAD 50 ml,
- 3 Plastiform DAV 50 ml,
- 2 Plastiform RGX80 50 ml.



Item No.	Description	Price EUR
783.218	Plastiform set	791.00

**Graduated rulers / Scale units / Circumference tapes
Precision tapes / Distance meters**



Accuracy of graduated rulers according DIN 2004/22

Measuring range (mm)	Max. permissible errors (\pm mm)	
	EG I	EG II
0- 500	0.15	0.40
0- 1000	0.20	0.50
0- 1500	0.25	0.60
0- 2000	0.30	0.70
0- 3000	0.40	0.90
0- 4000	0.50	1.10

Accuracy of graduated rulers according DIN 866 form A/B

Measuring range (mm)	Max. permissible errors (\pm mm)	
	form A	form B
0- 500	0.04	0.10
0- 1000	0.04	0.10
0- 1500	0.06	0.15
0- 2000	0.06	0.15
0- 3000	0.08	0.20
0- 4000	0.10	0.25
0- 5000	0.12	0.30

Rulers

- Material: bright steel or stainless steel.
- No graduation on first 5 mm at both ends.
- Graduation: 1 mm.
- Accuracy according DIN 866 form A.
- Scale numbering from right to left is available at extra cost.



Dimensions <i>l</i> x <i>w</i> x <i>t</i> /mm	Bright steel		Stainless steel	
	Item No.	Price EUR	Item No.	Price EUR
500 x 30 x 6	776.280	35.00	776.371	43.00
1000 x 40 x 8	776.281	71.00	776.366	106.00
1500 x 40 x 8	776.282	116.00	776.289	173.00
2000 x 50 x 10	776.283	188.00	776.399	290.00
3000 x 50 x 10	776.284	272.00	776.369	464.00
4000 x 60 x 12	776.285	508.00	776.407	842.00
5000 x 70 x 14	776.400	825.00	776.408	1,414.00
6000 x 70 x 14	776.401	1,034.00	776.409	1,770.00

Rulers

- Material: bright steel or stainless steel.
- Zero coincides with left end.
- Graduation: 1 mm.
- Accuracy according DIN 866 form B.
- Scale numbering from right to left is available at extra cost.



Dimensions <i>l</i> x <i>w</i> x <i>t</i> /mm	Bright steel		Stainless steel	
	Item No.	Price EUR	Item No.	Price EUR
500 x 25 x 5	776.270	19.50	776.276	26.30
1000 x 30 x 6	776.271	35.50	776.277	58.00
1500 x 30 x 6	776.272	60.00	776.360	107.00
2000 x 40 x 8	776.273	92.00	776.373	163.00
3000 x 40 x 8	776.274	170.00	776.357	267.00
4000 x 50 x 10	776.275	280.00	776.410	498.00
5000 x 60 x 12	776.396	576.00	776.395	832.00
6000 x 60 x 12	776.415	712.00	776.411	1,097.00



Rulers

Rulers with beveled edge for parallax-free reading.

- Graduation: 1 mm.
- Accuracy according DIN 866 form B.
- Bright steel or stainless steel.
- Zero coincides with left end.
- Scale numbering from right to left is available at extra cost. Also available without scale numbering.

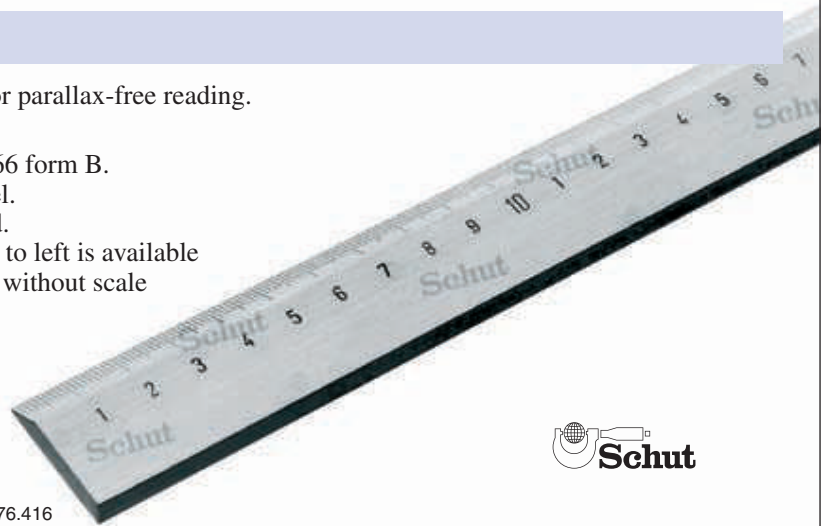

776.416



Dimensions <i>l x w x t</i> /mm	Bright steel		Stainless steel	
	Item No.	Price EUR	Item No.	Price EUR
500 x 30 x 6	776.416	59.00	776.250	73.00
1000 x 40 x 8	776.417	165.00	776.251	196.00
1500 x 40 x 8	776.398	238.00	776.252	329.00
2000 x 50 x 10	776.418	312.00	776.253	460.00
3000 x 50 x 10	776.419	453.00	776.254	679.00
4000 x 60 x 12	776.420	762.00	776.255	1,253.00

Hardened and ground rulers

No-glare chrome finished stainless steel.

With mm/0.5 mm graduation

Upper edge: mm graduation, lower edge:
0.5 mm graduation.

Item No.	Dimensions <i>l x w x t</i> /mm	Price EUR
775.300	150 x 15 x 0.5	3.50
775.301	300 x 25 x 1	7.40

With mm/mm graduation

The first 100 mm on the lower edge have a
0.5 mm graduation.

Item No.	Dimensions <i>l x w x t</i> /mm	Price EUR
775.302	600 x 30 x 1.2	19.50
775.303	1000 x 35 x 1.5	39.20
775.304	2000 x 41 x 2	204.00
775.305	3000 x 39 x 3	515.00



775.302

Hardened and polished rulers

- Stainless steel construction.
- With mm graduation on the upper edge.
- With 0.5 mm graduation on the lower edge.



Item No.	Dimensions l x w x t/mm	Price EUR
775.580	150 x 15 x 0.6	1.20
775.582	450 x 29 x 1	5.90
775.583	600 x 29 x 1.2	8.80
775.584	1000 x 35 x 1.2	12.60
775.585	1500 x 40 x 2	69.00
775.586	2000 x 40 x 2	93.00

Aluminum rulers

- Anodized.
- With mm graduation.



775.590



775.600



Item No.	Dimensions l x w x t/mm	Price EUR
With slip-stopper:		
775.590	300 x 35 x 1.5	2.50
775.592	600 x 35 x 1.5	5.50
775.593	1000 x 35 x 1.5	8.50
With handle and magnet:		
775.600	450 x 50 x 3	9.30
775.602	1000 x 50 x 3	19.70

Self-adhesive rulers

- Measuring range: 0-400 mm.
- Graduation: 1 mm, vernier: 0.1 mm.
- Blue anodized aluminum.
- With self-adhesive back.
- Suitable for positioning on measuring devices and machine elements.



Vernier 0.1 mm

- 10 scale divisions on 9 mm.
- Non-adhesive, furnished with two fixing holes $\varnothing 2.5$ mm.

Item No.	Measuring range/mm	Dimensions l x w x t/mm	Price EUR
775.901	0-200	208 x 16 x 0.5	5.70
775.902	0-300	308 x 16 x 0.5	7.40
775.903	0-400	408 x 16 x 0.5	13.90
775.900	Vernier 0.1 mm	40 x 10 x 0.5	2.40

Stainless steel rulers with L → R or R → L numbering

- Measuring range: 0 - 12000 mm.
- Graduation: 1 mm (type B: 0.5 mm).
- No-glare finished stainless steel surface.
- EC class II.
- Etched graduation.
- The rulers up to 4000 mm are conform EC class II.

Available on request:

- with graduation from top to bottom or from bottom to top,
- with different combinations (mm/mm, mm/inch, mm/blanc, etc.),
- with 0-point in the middle.

NEW



Item No.	Price EUR	Item No.	Price EUR	Item No.	Price EUR	Item No.	Price EUR	Dimensions l x w x t/mm
L → R type A:		R → L type A:		L → R type B:		R → L type B:		
835.120	1.60	835.121	1.60	835.421	1.90	835.422	1.90	150 x 13 x 0.5
835.122	1.70	835.123	1.70	835.298	2.00	835.440	2.00	200 x 13 x 0.5
835.124	1.90	835.125	1.90	835.427	2.20	835.441	2.20	250 x 13 x 0.5
835.126	2.10	835.127	2.10	835.129	2.10	835.442	2.50	300 x 13 x 0.5
835.130	3.70	835.131	3.70	835.354	4.40	835.443	4.40	500 x 18 x 0.5
835.132	9.00	835.133	9.00	835.252	10.70	835.444	10.70	1000 x 18 x 0.5
835.134	16.90	835.135	16.90	835.428	20.10	835.445	20.10	1500 x 18 x 0.5
835.136	19.90	835.137	19.90	835.429	23.70	835.446	23.70	2000 x 18 x 0.5
835.138	34.90	835.139	34.90	835.430	42.00	835.447	42.00	2500 x 18 x 0.5
835.140	46.00	835.141	46.00	835.431	55.00	835.448	55.00	3000 x 18 x 0.5
835.142	61.00	835.143	61.00	835.432	73.00	835.449	73.00	3500 x 18 x 0.5
835.144	68.00	835.145	68.00	835.433	81.00	835.450	81.00	4000 x 18 x 0.5
835.146	98.00	835.147	98.00	835.413	117.00	835.451	117.00	5000 x 18 x 0.5
835.148	126.00	835.149	126.00	835.434	151.00	835.452	151.00	6000 x 18 x 0.5
835.150	362.00	835.151	362.00	835.035	432.00	835.453	432.00	7000 x 30 x 1
835.152	410.00	835.153	410.00	835.435	490.00	835.454	490.00	8000 x 30 x 1
835.154	465.00	835.155	465.00	835.436	555.00	835.455	555.00	9000 x 30 x 1
835.156	509.00	835.157	509.00	835.437	607.00	835.456	607.00	10000 x 30 x 1
835.158	530.00	835.159	530.00	835.438	632.00	835.457	632.00	11000 x 30 x 1
835.160	546.00	835.161	546.00	835.439	651.00	835.458	651.00	12000 x 30 x 1



Type A: mm/mm (bottom and top side 1 mm graduation).

Type B: 0.5 mm/1 mm (top side 0.5 mm, bottom side 1 mm graduation).

Rulers with a self-adhesive back

Item No.	Additional costs	Price EUR
835.165	For rulers up to 1000 mm (price per piece)	10.10
	For rulers from 1000 mm (price per meter)	10.10

The self-adhesive back is *not* separately available.



With 0-point in the middle

Item No.	Dimensions l x w x t/mm	Price EUR
835.266	200 x 13 x 0.5	7.60

Other sizes are also available.

Rulers

Stainless steel rulers with laser engraving

- With mm/mm graduation from left to right.
- Graduation: 1 mm.
- With identification number.
- EC class I.



835.462



Stainless steel rulers with magnet inserts

- Graduation from left to right.
- Laser engraving.
- With 2 flat edges without hanger hole.
- Graduation on front and back side.
- Graduation: front side: 1 mm, 0.5 mm, back side: 1/32", 1/64".
- With removeable magnet inserts.
- EC class II.

835.473

Rulers (black) with laser engraving

- Graduation on front and back side.
- Graduation: front side: 1 mm, 0.5 mm, back side: 1/10", 1/16", 1/20", 1/32", 1/64", 1/50", 1/100".
- EC class II.



835.466

Stainless steel rulers with 90° anvil hook

- Graduation from left to right.
- Etched graduation.
- Graduation: front side: 1 mm, back side: 0.5 mm.
- EC class II.



835.476

NEW



Item No.	Dimensions l x w x t / mm	Material	Class	Price EUR
Stainless steel rulers with laser engraving:				
835.096	150 x 13 x 0.5	No-glare finished stainless steel surface	EC class I	6.40
835.459	300 x 13 x 0.5	No-glare finished stainless steel surface	EC class I	13.00
835.460	500 x 20 x 0.5	No-glare finished stainless steel surface	EC class I	18.60
835.461	1000 x 20 x 0.5	No-glare finished stainless steel surface	EC class I	40.00
835.462	300 x 30 x 1.0	No-glare finished stainless steel surface	EC class I	13.00
835.463	500 x 30 x 1.0	No-glare finished stainless steel surface	EC class I	19.50
835.464	1000 x 30 x 1.0	No-glare finished stainless steel surface	EC class I	39.00
835.465	2000 x 30 x 1.0	No-glare finished stainless steel surface	EC class I	79.00
Rulers (black) with laser engraving:				
835.466	150 x 18 x 0.5	Steel, black surface	EC class II	8.20
835.467	300 x 30 x 1.0	Steel, black surface	EC class II	14.40
835.468	450 x 30 x 1.0	Steel, black surface	EC class II	20.00
835.469	600 x 30 x 1.0	Steel, black surface	EC class II	26.70
835.470	1000 x 30 x 1.0	Steel, black surface	EC class II	44.00
Stainless steel rulers with magnet inserts:				
835.471	150 x 20 x 1.0	No-glare finished stainless steel surface	EC class II	17.00
835.472	300 x 30 x 1.0	No-glare finished stainless steel surface	EC class II	33.30
835.473	600 x 30 x 1.0	No-glare finished stainless steel surface	EC class II	71.00
835.474	900 x 30 x 1.0	No-glare finished stainless steel surface	EC class II	106.00
835.475	1200 x 30 x 1.0	No-glare finished stainless steel surface	EC class II	142.00
Stainless steel rulers with 90° anvil hook:				
835.476	200 x 13 x 0.5	No-glare finished stainless steel surface	EC class II	7.20
835.477	300 x 13 x 0.5	No-glare finished stainless steel surface	EC class II	8.20
835.478	500 x 18 x 0.5	No-glare finished stainless steel surface	EC class II	16.20

Digital horizontal scale units

These scale units are available in two different models. Up to 300 mm the model matches the photo of the 906.403, from 450 mm the photo of the 906.406.

- Measuring range: 0- 1000 mm.
- Resolution: 0.01 mm.
- Repeatability: 0.01 mm.
- mm/inch conversion.
- ABS/INC switchable (from 450 mm).
- On/off switch.
- Preset (from 450 mm).
- Reset.
- Max. measuring speed:
 < 500 mm: 1.5 m/s,
 ≥ 500 mm: 1 m/s.
- Delivery with mounting material.
- Power supply: 1 battery type V357.
- Power supply:
 906.400- 403: 1 battery type V357,
 906.404- 409: 1 battery type CR2032.

Item No.	Measuring range/mm	Accuracy mm	Price EUR
906.400	0- 100	±0.03	42.00
906.401	0- 150	±0.03	43.00
906.402	0- 200	±0.03	56.00
906.403	0- 300	±0.04	89.00
906.404	0- 450	±0.05	125.00
906.405	0- 500	±0.05	165.00
906.406	0- 600	±0.05	210.00
906.408	0- 800	±0.06	313.00
906.409	0- 1000	±0.07	417.00
Options:			
836.535	Spare battery type V357		1.90
495.157	Spare battery type CR2032		0.50



Digital vertical scale units

- Measuring range: 0- 1000 mm.
- Resolution: 0.01 mm.
- Repeatability: 0.01 mm.
- mm/inch conversion.
- ABS/INC switchable.
- On/off switch.
- Reset/preset.
- Max. measuring speed: 1 m/s.
- Delivery with mounting material.
- Power supply: 1 battery type V357.

Item No.	Measuring range/mm	Accuracy mm	Price EUR
906.415	0- 100	±0.03	69.00
906.416	0- 150	±0.03	72.00
906.417	0- 200	±0.03	96.00
906.418	0- 300	±0.04	124.00
906.419	0- 450	±0.05	150.00
906.420	0- 500	±0.05	180.00
906.421	0- 600	±0.05	229.00
906.423	0- 800	±0.06	335.00
906.424	0- 1000	±0.07	483.00
Option:			
836.535	Spare battery		1.90



TESA TWIN-Cal digital horizontal scale units IP67

New generation IP67 scale units with a large measuring range up to 1000 mm, TESA TWIN-Cal, with an absolute measuring system and a “soft touch” grip. These scale units have a unique connectivity concept TWIN & LINK. All TWIN-Cal scale units are equipped with a data output. Connect the TESA Link Connector (or TWIN-Cap) to the TWIN-Cal for “plug and play” (wireless) data transfer.

- Measuring range: 0-1000 mm.
- Resolution: 0.01 mm.
- mm/inch conversion.
- Digit height: 11 mm.
- Automatic switch-off.
- Reset.
- Max. measuring speed: approx. 2.5 m/s.
- Locking screw.
- Protection: IP67 (also in combination with data output cable).
- Standard supplied with data output (USB, Digimatic or wireless).
- Delivery in a case with an inspection report and a declaration of conformity.
- Power supply: 1 battery type CR2032.

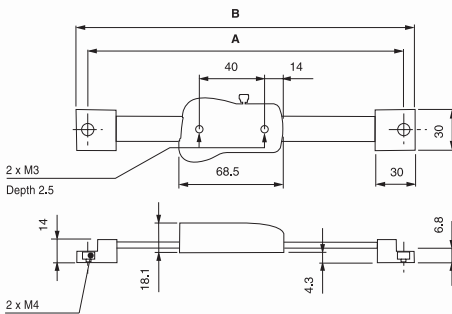

Item No.	Measuring range/mm	Accuracy mm	Length/mm		Price EUR
			A	B	
783.361	0- 150	±0.03	265	278	445.00
783.362	0- 300	±0.03	415	428	522.00
783.363	0- 600	±0.03	725	738	675.00
783.364	0-1000	±0.04	1135	1148	1,010.00
Options:					
495.157	Spare battery				0.50
783.301 ¹	TESA Link Connector USB				118.00
783.302 ¹	TESA Link Connector Digimatic				170.00
783.303 ¹	TESA Link Connector TWIN-Cap				159.00

¹ The TESA Link Connector will replace the battery cover.



Mitutoyo digital horizontal and vertical scale units

These scale units are ideal for a simple digital read-out of linear movements on e.g. machines and measuring systems.

- Measuring range: 0- 300 mm.
- Resolution: 0.01 mm.
- ABS/INC switchable.
- Digimatic data output.
- On/off switch.
- Reset.
- Protection: IP66
(only *Coolant Proof* models).
- Conforms to factory standard.
- Power supply: 1 battery type V357.



*Data cables Digimatic,
USB Input Tool Direct, U-WAVE
available on request.*



Item No.	Measuring range/mm	Accuracy mm	Price EUR
Horizontal:			
572.200	0- 100	±0.03	233.00
572.201	0- 150	±0.03	244.00
572.202	0- 200	±0.03	282.00
572.203	0- 300	±0.04	498.00
Horizontal, IP66 (<i>Coolant Proof</i>):			
572.600	0- 100	±0.03	270.00
572.601	0- 150	±0.03	288.00
572.602	0- 200	±0.03	342.00
Vertical:			
572.560	0- 100	±0.03	436.00
572.561	0- 150	±0.03	508.00
572.562	0- 200	±0.03	563.00
572.563	0- 300	±0.04	640.00

Option:

Item No.	Description	Price EUR
836.535	Spare battery	1.90



Schwenk internal circumference tapes

Circumference tapes to measure the internal circumferences and the average cross-section of round and not-round bores. The surface may be smooth or rough.

- Separate graduations for circumference and diameter in mm.
- Vernier: 0.1 mm.
- Tape width: 20 mm.
- Universal clamp for all types.
- Delivery without clamping jaw.
- Stainless steel construction.
- Accuracy according DIN 866.
- Available up to: diameter 2700 mm.

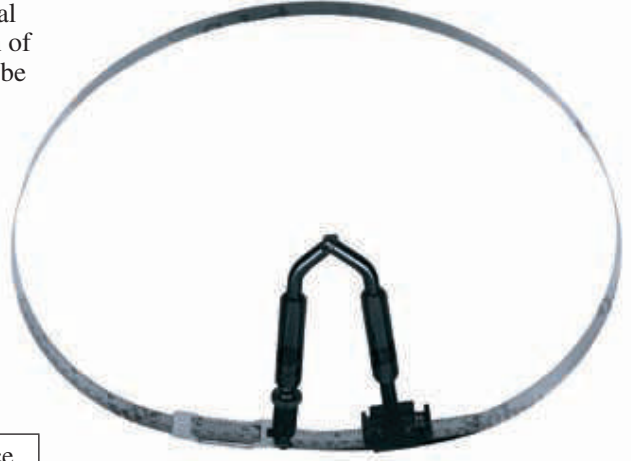

Item No.	Diameter mm	Circumference mm	Price EUR
852.645	230- 490	720-1550	225.00
852.646	300- 700	940-2200	236.00
852.647	700-1100	2190-3460	252.00
852.648	1100-1500	3450-4720	289.00
852.649	Clamping jaw		340.00



Circumference tapes

- Separate graduations for circumference and diameter in mm.
- Vernier: 0.1 mm.
- Bright steel or stainless steel.
- Accuracy according DIN 2768 T1-m.
- With measuring report on request.



835.101

Bright steel

Item No.	Diameter mm	Circumference mm	Price EUR
835.111	20- 300	60- 950	47.00
835.112	300- 700	940- 2200	57.00
835.113	700-1100	2190- 3460	72.00
835.114	1100-1500	3450- 4720	88.00
835.115	1500-1900	4710- 5980	107.00
835.116	1900-2300	5960- 7230	122.00
835.117	2300-2700	7220- 8500	212.00
835.118	2700-3100	8480- 9760	228.00
835.119	3100-3500	9730-11010	270.00

Stainless steel

Item No.	Diameter mm	Circumference mm	Price EUR
835.101	20- 300	60- 950	66.00
835.102	300- 700	940- 2200	83.00
835.103	700-1100	2190- 3460	103.00
835.104	1100-1500	3450- 4720	123.00
835.105	1500-1900	4710- 5980	141.00
835.106	1900-2300	5960- 7230	174.00
835.107	2300-2700	7220- 8500	238.00
835.108	2700-3100	8480- 9760	287.00
835.109	3100-3500	9730-11010	352.00

Schwenk circumference tapes

Highly precise circumference tapes, on which the scales have been placed by means of a laser.

- Separate graduations for circumference and diameter in mm.
- Vernier: 0.1 mm.
- Tape width: 16 mm.
- Accuracy according DIN 866.
- The black model (stainless steel) is for a better contrast.
- Available on request:
 - circumference scale in inches,
 - for larger diameters up to 7500 mm,
 - with measuring reports for one or both scales,
 - vernier 0.05 mm on diameter reading.



Item No.	Diameter mm	Circumference mm	Price EUR
Bright steel:			
852.823	20- 300	60- 950	54.00
852.824	300- 700	940- 2200	66.00
852.825	700-1100	2190- 3460	80.00
852.826	1100-1500	3450- 4720	99.00
852.827	1500-1900	4710- 5980	119.00
852.828	1900-2300	5960- 7230	134.00
852.829	2300-2700	7220- 8500	219.00
852.830	2700-3100	8480- 9760	236.00
852.831	3100-3500	9730-11010	278.00
Stainless steel:			
852.832	20- 300	60- 950	66.00
852.833	300- 700	940- 2200	85.00
852.834	700-1100	2190- 3460	116.00
852.835	1100-1500	3450- 4720	145.00
852.836	1500-1900	4710- 5980	174.00
852.837	1900-2300	5960- 7230	203.00
852.838	2300-2700	7220- 8500	239.00
852.839	2700-3100	8480- 9760	288.00
852.840	3100-3500	9730-11010	353.00
Black model:			
852.699	20- 300	60- 950	84.00
852.915	300- 700	940- 2200	103.00
852.280	700-1100	2190- 3460	134.00
852.281	1100-1500	3450- 4720	163.00
852.282	1500-1900	4710- 5980	193.00
852.283	1900-2300	5960- 7230	225.00
852.284	2300-2700	7220- 8500	265.00
852.285	2700-3100	8480- 9760	311.00
852.286	3100-3500	9730-11010	382.00

Schwenk circumference tapes for diameters

Circumference tapes for highly accurate measuring of diameters. The graduation has been placed by means of a laser.

- Graduation in mm.
- Vernier: 0.05 mm.
- Tape width: 12 mm.
- Stainless steel construction.
- Accuracy according DIN 866.
- The black model (stainless steel) is for a better contrast.
- Available on request:
 - measuring report.

Item No.	Diameter/mm	Price EUR
852.820	15- 115	76.00
852.821	100- 230	113.00
852.822	200- 330	119.00
852.984	300- 620	155.00
Black model:		
852.706	15- 115	106.00
852.788	100- 230	150.00
852.287	200- 330	153.00
852.288	300- 620	193.00



Precision tapes

Cost effective rubberized precision tapes.

- Yellow varnished steel strip with mm graduation.
- One-sided printed blade.
- Matt finished steel blade.
- EC class II.
- Standard EC-type hook.



910.060



910.057



NEW

Item No.	Length m	Tape width mm	Price EUR
910.056	2	16	2.50
910.057	3	16	2.80
910.058	5	19	4.10
910.059	8	25	7.40
910.060	10	25	9.90

Precision tapes

Precision tapes for professional use with double-sided printed blade and double hook with magnet.

- EC class II (except 910.064).
- EC class I (only 910.064).
- Shockproof til 2 m.
- Matt finished steel blade.
- Double-sided printed blade (except 910.064).
- Blade horizontal stand-out:
19 mm: 1.7 m, 27 mm: 2.8 m.
- EC-type magnet dual hook (except 910.064).
- Double lock (except 910.064).
- Delivery with an inspection report (only 910.064).



910.062

NEW



910.062



Item No.	Length m	Tape width mm	Price EUR
910.061	3	19	6.00
910.062	5	27	10.40
910.063	10	27	18.20
EC class I:			
910.064	3	19	14.50

Long stroke precision tape

Long stroke precision tape with blade from fiberglass and with high speed retracting gear.

- Double-sided printed blade.
- EC class II.



NEW



Item No.	Length m	Tape width mm	Price EUR
910.065	30	15	16.20

Precision tapes Top-Stop / Double-Stop

- Yellow varnished steel strip with mm graduation.
- EC class II.
- Chrome colored, plastic housing.
- Stop button on top (775.500/503).
- Double stop button (775.506).



775.503



775.506

Item No.	Type	Length m	Tape width mm	Price EUR
775.500	Top-Stop	2	13	1.80
775.503	Top-Stop	3	16	2.20
775.506	Double-Stop	5	19	3.70

Long stroke precision tapes



775.543

- Black plastic housing with wristlet.
- White varnished steel strip with mm graduation.
- Winding-on handle.
- EC class II.

Item No.	Length m	Tape width mm	Price EUR
775.540	10	9.5	7.10
775.541	15	9.5	8.70
775.542	20	9.5	9.90
775.543	30	9.5	11.40

Digital measuring tape

Digital measuring tape equipped with a 19 mm wide tape, which is provided with a clear graduation. The digital indication is convertible from external to internal measurements and can be reset to zero at any point on the tape.

- Measuring range: 0-5 m.
- Resolution: 1 mm.
- Accuracy: $\pm(0.3+0.2L)$ mm (L in m).
- mm/inch conversion.
- Hold function.
- Reversal of display value.
- Automatic stop.
- Convertible for internal/external measurements.
- Storage for 8 measuring values.
- Dimensions: 75 x 70 mm.
- Power supply: 1 battery type CR2032.



Item No.	Length m	Tape width mm	Price EUR
909.341	5	19	32.80
Option:			
495.157	Spare battery		0.50

Digital measuring wheel

With this measuring wheel long distance measurements can be done quickly and easily.

- Measuring range: 0- 10000 m.
- Resolution: 0.1 m.
- Accuracy: <0.5%.
- m/ft conversion.
- Wheel size: \varnothing 160 mm.
- Display located near handle.
- Adjustable in height.
- Reset.
- Storage for 5 values.
- Weight: 0.8 kg.
- Delivery incl. pouch.
- Power supply: 2 batteries type AAA.
- Measuring range: 103.5 - 500 cm.
- With mm graduation.
- Aluminum model with steel measuring faces.
- With circular spirit level (for vertical use) and horizontal spirit level.
- Delivery in a case.



Item No.	Description	Price EUR
909.518	Digital measuring wheel	48.00
Option:		
497.914	Spare battery (2 needed)	0.40

Telescopic scale



Item No.	Description	Price EUR
909.519	Telescopic scale	52.00

Leica DISTO laser distance meter

With this compact hand laser distance meter you aim a visual laser spot at the object for quick and accurate measurements of the distance without contact. Beside the model shown below there are various other types available with extended functions.

- Measuring range: 0.05 - 100 m.
- Resolution: 0.001 m.
- Accuracy: ± 1.5 mm.
- Distance, surface and volume measurements, continuous measurements, addition and subtraction, min/max function, multifunctional end-piece and Pythagoras function.
- mm/inch conversion.
- Illuminated LCD display.
- On/off switch, automatic switch-off.
- Storage of the last measuring values.
- Bluetooth Smart.
- Measurement reference: front or rear.
- Dimensions and weight (incl. batteries): D2: 116 x 44 x 26 mm, 100 g.
- Protection: IP54.
- Laser: 635 nm, class II according IEC 60825-1.
- Power supply: 2 batteries type AAA.
- Available with a declaration of conformity.
- Various other types available.

NEW



774.244

Item No.	Type	Measuring range/m	Price EUR
774.244	DISTO D2	0.05 - 100	189.00
Options:			
497.914	Spare battery (2 needed)		0.40
774.059	Laser glasses for visible laser beam		44.00

Laser distance meters

With these compact hand laser distance meters you aim a visual laser spot at the object for quick and accurate measurements of the distance without contact.

- Measuring range: 0 - 80 m.
- Resolution: 0.001 m/0.01 m.
- Accuracy: ± 2 mm.
- Distance, surface and volume measurements, continuous measurements, addition and subtraction, min/max function and Pythagoras function.
- mm/inch/ft conversion.
- Illuminated LCD display.
- On/off switch, automatic switch-off.
- Measurement reference: front or rear.
- Storage for 99 measuring values.
- With thread for tripod.
- Laser: 635 nm, class II according IEC 60825-1.
- Dimensions: 120 x 55 x 30 mm.
- Weight: 909.453: 180 g, 909.454: 128 g.
- Power supply: 2 batteries type AAA.



Item No.	Measuring range/m	Price EUR
909.453	0 - 40	80.00
909.454	0 - 80	111.00
Option:		
497.914	Spare battery	0.40



909.454

Scribing tools / Compasses / Center squares



CI5.000.EN.20170420

Marking gauges

- Measuring range: 0 - 400 mm.
- Vernier: 0.1 mm.
- No-glare chrome finished beam.
- Roll stop.



Item No.	Measuring range/mm	Price EUR
836.602	0 - 200	26.40
836.604	0 - 400	38.50
836.603	Spare scriber point	4.30

Marking gauges

- Measuring range: 0 - 500 mm.
- Vernier: 0.1 mm.
- With round rod and mm graduation.
- No-glare chrome finished.



907.187

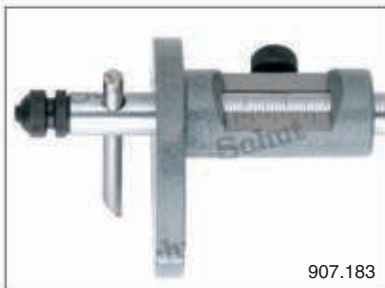

907.183

Item No.	Measuring range/mm	Price EUR
Without fine adjustment:		
907.183	0 - 200	31.20
907.184	0 - 300	36.40
907.185	0 - 400	49.00
907.186	0 - 500	56.00
With fine adjustment:		
907.187	0 - 200	36.40
907.188	0 - 300	44.00
907.189	0 - 400	52.00
907.190	0 - 500	63.00
907.191	Spare scriber point (TC)	3.50

Marking calipers

T-shaped stainless steel marking caliper with a large marking face/cross scale. The marking face is sunk into the U-shaped base face.

- Measuring range: 0- 500 mm.
- Locking screw.
- Vernier: 0.05 mm.
- With or without fine adjustment.
- No-glare chrome finished beam.
- Marking face/cross scale with mm graduation (50-0-50 mm).

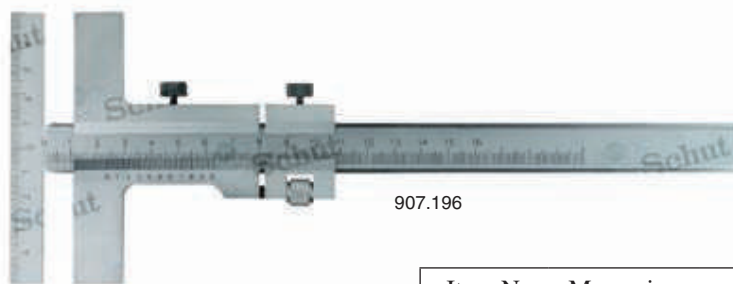

907.196



PRICE

Item No.	Measuring range/mm	Base length/mm	Price EUR
Without fine adjustment:			
907.575	0-160	140	62.00
907.576	0-250	140	79.00
907.577	0-300	160	118.00
With fine adjustment:			
907.196	0-160	140	80.00
907.197	0-250	140	101.00
907.198	0-300	160	117.00
907.199	0-500	160	152.00

Marking gauges

- Measuring range: 0- 300 mm.
- Vernier: 0.1 mm.
- No-glare chrome finished beam.



907.180

PRICE

Item No.	Measuring range/mm	Price EUR
907.180	0-200	14.50
907.181	0-250	17.40
907.182	0-300	27.10

Scriber



Item No.	Description	Price EUR
909.388	Scriber with clip, with tungsten carbide exchangeable point and magnetic upper part	4.50
Replacement point:		
909.389	1 tungsten carbide scriber point for 909.388	2.40

Trammels

- Round rod with graduation.
 - Milled key groove.
 - Vernier: 0.1 mm.
 - Fine adjustment.
- (Also available without fine adjustment.)



Item No.	Length/mm	Price EUR
671.275	500	178.00
671.276	1000	215.00
671.277	1500	343.00
671.278	2000	407.00
Needles per pair:		
671.234	Hardened steel	15.10
671.239	Tungsten carbide	37.80

Trammels

- Flat beam with graduation.
- Vernier: 0.1 mm.
- Fine adjustment.

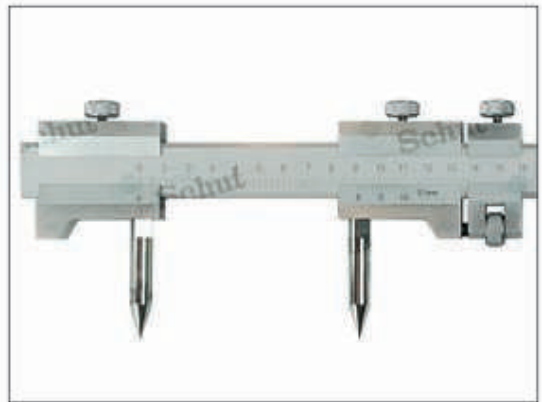

Item No.	Length/mm	Price EUR
671.261	500	71.00
671.262	1000	136.00
671.263	1500	219.00
671.264	2000	205.00
Needles per pair:		
671.230	Hardened steel	8.60
671.235	Tungsten carbide	35.90

Spring joint dividers

- Stainless steel construction.
- With adjustment screw.
- With interchangeable points (910.012-018, 907.447-448).
- With pencil holder (907.447-448).



Item No.	Description	Price EUR
907.446	Spare divider point $\varnothing 2 \times 30$ mm	1.20

Length/mm	Item No.	Price EUR	Item No.	Price EUR	Item No.	Price EUR
100	–	–	910.012	9.50	–	–
125	–	–	910.013	10.70	–	–
150	907.827	7.80	910.014	11.30	907.447	7.40
175	–	–	910.015	12.60	–	–
200	907.828	8.90	910.016	14.20	907.448	9.90
250	907.829	10.30	910.017	16.10	–	–
300	907.830	11.40	910.018	17.30	–	–
400	907.831	19.70	–	–	–	–
500	907.832	25.70	–	–	–	–
600	907.833	34.30	–	–	–	–

Firm joint compasses

- Stainless steel construction.
- With adjustment arch and locking screw (907.818-826, 909.461-469).
- With pencil holder (909.461-469).



Length/mm	Item No.	Price EUR	Item No.	Price EUR	Item No.	Price EUR
150	907.809	5.20	907.818	5.80	909.461	9.40
200	907.810	8.20	907.819	8.40	909.462	11.90
250	907.811	8.50	907.820	10.00	909.463	13.80
300	907.812	10.80	907.821	12.40	909.464	15.70
400	907.813	20.30	907.822	20.80	909.465	20.80
500	907.814	28.00	907.823	32.00	909.466	29.30
600	907.815	35.60	907.824	38.20	909.467	35.50
800	907.816	64.00	907.825	66.00	909.468	94.00
1000	907.817	92.00	907.826	99.00	909.469	116.00

Internal spring joint compasses

- Stainless steel construction.
- With adjustment screw.



Item No.	Length/mm	Price EUR
907.793	100	6.50
907.794	125	7.40
907.795	150	9.20
907.796	200	10.10
907.797	250	10.30
907.798	300	11.40
907.799	400	18.80
907.800	500	25.70

External spring joint compasses

- Stainless steel construction.
- With adjustment screw.



Item No.	Length/mm	Price EUR
907.801	100	7.30
907.802	125	7.00
907.803	150	7.40
907.804	200	8.90
907.805	250	9.80
907.806	300	11.40
907.807	400	18.80
907.808	500	24.50

Firm joint compasses

- Stainless steel construction.



Item No.	Length/mm	Price EUR
907.836	100	3.10
907.837	125	3.30
907.838	150	4.00
907.839	200	6.10
907.840	250	8.90
907.841	300	9.60
907.842	400	17.80
907.843	500	20.30
907.844	600	30.50
907.845	800	56.00
907.846	1000	69.00

Firm joint compasses

- Stainless steel construction.



Item No.	Length/mm	Price EUR
907.847	100	3.70
907.848	125	4.00
907.849	150	4.00
907.850	200	6.50
907.851	250	8.90
907.852	300	9.70
907.853	400	18.80
907.854	500	21.60
907.855	600	32.30
907.856	800	57.00
907.857	1000	70.00

Center squares

Center squares with mm graduation on the blade, to mark the center on round discs or axes.

- Stainless steel construction, no-glare chrome finished.
- Graduation placed by laser.

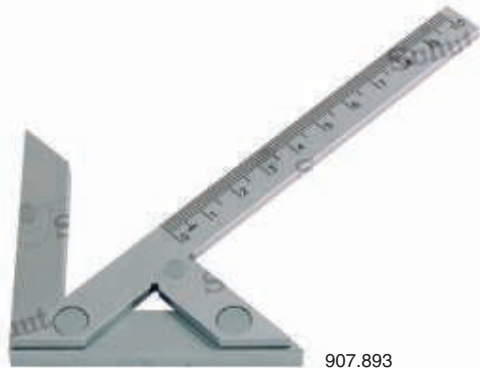

907.893

Item No.	Length/mm		Max. ϕ mm	Price EUR
	l_1	l_2		
907.893	100	70	90	26.20
907.894	150	130	190	30.00
907.895	200	150	220	34.80
907.896	250	160	230	59.00
907.897	300	180	280	73.00
909.972	400	250	380	98.00
909.973	500	330	530	142.00

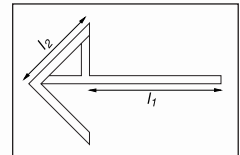

Caliper compasses

- For scribing of diameters of 0-600 mm.
- Vernier: 0.1 mm.
- Stainless steel construction, no-glare chrome finished.
- Fixed jaw and beam made out of one piece.
- Hardened, ground and lapped measuring faces.



909.425

Item No.	For scribing up to ϕ /mm	Meas. range mm	Jaw length mm	Price EUR
909.424	300	150	40	41.00
909.425	400	200	40	49.00
909.426	500	250	40	55.00
909.427	600	300	40	62.00



Universal setting instrument

This multilateral instrument is specially designed for manufacturers of very accurate products, such as gauges and toolmakers. The guide is installed under an angle of 20° and the components can be moved very accurately. The movable component has several threaded bores M4, by which the setting instrument also can be used as a scriber or height gauge.

- Max. height range incl. extensions: 270 mm.
- Dimensions: 133 x 64 x 18.5 mm.
- Delivery with extensions 25 mm and 75 mm (equipped with thread M4/thread hole M4).
- Base with vial.



Item No.	Description	Price EUR
906.455	Universal setting instrument	97.00



906.455

Surface gauge

Stable foot with V-slot at the ground surface, grips at the side and is also equipped with two bores (ø5.5 mm).

- Foot ground all around (except for the V-slot).
- Fine adjustment.
- Dimensions:
 scriber: ø 4 x 200 mm,
 arm: ø 10 x 300 mm, ø 10 x 450 mm,
 foot: 85 x 65 x 25 mm.



Item No.	Description	Price EUR
906.220	Surface gauge	20.50



Height and scribing gauges / Height gauges



Digital height and scribing gauges

- Measuring range: 0 - 1000 mm.
 - Resolution: 0.01 mm.
 - mm/inch conversion.
 - ABS/INC switchable.
 - On/off switch.
 - Reset.
 - Hold function.
 - Fine adjustment.
 - Delivery incl. scriber.
 - Power supply:
 - 909.244/245/246: 1 battery type V357,
 - 906.267/268: 1 battery type CR2032.
- From measuring range 500 mm:**
- Tolerance function.
 - Preset.



Item No.	Measuring range/mm	Accuracy mm	Price EUR
906.267	0 - 200	±0.03	108.00
906.268	0 - 300	±0.04	133.00
909.244	0 - 500	±0.05	183.00
909.245	0 - 600	±0.07	211.00
909.246	0 - 1000	±0.07	397.00
Options:			
836.535	Spare battery type V357		1.90
495.157	Spare battery type CR2032		0.50
906.029	Scriber for 906.267		12.60
906.049	Scriber for 906.268		12.60
906.054	Scriber for 909.244		20.60
906.075	Scriber for 909.245		20.60
906.077	Scriber for 909.246		34.30



Absolute digital height and scribing gauges

Digital height and scribing gauges with an absolute measuring system.

- Measuring range: 0 - 600 mm.
 - Resolution: 0.01 mm.
 - Handwheel drive for easy head displacement.
 - Interchangeable scriber, intake 9 x 9 mm.
 - ABS/INC switchable.
 - Digimatic data output.
 - On/off switch.
 - Reset.
 - Hold function.
 - Locking screw.
- Delivery incl. scriber, dial indicator holder, Digimatic data cable and AC adapter.
 - Power supply: 1 battery type CR2032 or AC adapter.

NEW



910.096



910.096



909.686



909.687



910.039/038



Item No.	Measuring range/mm	Accuracy mm	Price EUR
910.096	0 - 300	0.03	282.00
910.097	0 - 600	0.05	406.00
With Bluetooth:			
910.098	0 - 300	0.03	302.00
Options:			
495.157	Spare battery		0.50
909.686	USB interface		101.00
909.687	Footswitch for USB interface		17.30
910.038	Wireless USB receiver		47.00
910.039	Wireless sender		47.00
906.256	Scriber		32.30

Special digital height and scribing gauges

The dual display model shows the measuring value on the displays on both sides of the instrument, ideal for left handed use. The magnetic base model is made primarily of plastic, which makes it very light and easy to handle. Due to the magnets in the flat plastic base the instrument can also be placed on magnetic surfaces at an angle.

- Measuring range: 0- 150 mm.
 - Resolution: 0.01 mm.
 - mm/inch conversion.
 - On/off switch.
 - Delivery incl. scriber.
 - Double display (906.225).
 - Magnetic base (906.226).
- Power supply:
906.225: 1 battery type V357,
906.226: 1 battery type CR2032.



Item No.	Accuracy/mm	Price EUR
906.225	±0.03	75.00
906.226	±0.4	30.90
Options:		
836.535	Spare battery type V357	1.90
495.157	Spare battery type CR2032	0.50
906.344	Scriber for 906.225	13.90
906.354	Scriber for 906.226	11.50



Digital height and scribing gauge with dial indicator holder

Solid and stable instrument with integrated dial indicator holder and stainless measuring table.

- Measuring range: 0- 500 mm.
 - Resolution: 0.01 mm.
 - mm/inch conversion.
 - ABS/INC switchable.
 - On/off switch.
 - Preset.
 - Reset.
 - Hold function.
 - Tolerance function.
 - Fine adjustment.
 - Intake scriber: 8 x 6 mm.
 - Delivery incl. scriber.
- Dial gauge clamping shaft 8 mm.
 - Measuring table: 906.115/116: 80 x 80 mm,
906.117: 110 x 100 mm.
 - Power supply: 1 battery type V357.



Item No.	Measuring range/mm	Accuracy mm	Price EUR
906.115	0- 200	±0.04	221.00
906.116	0- 300	±0.04	276.00
906.117	0- 500	±0.06	403.00
Option:			
836.535	Spare battery		1.90
906.343	Scriber		26.60



Digital double columns height and scribing gauges

This is a very stable digital height gauge because of its twin guide system. The measuring unit moves over two independent columns with high precision toothed racks, which generates an accurate measurement.

- Measuring range: 0 - 600 mm.
- Resolution: 0.01 mm.
- Repeatability: 0.01 mm.
- Handwheel drive for easy head displacement.
- mm/inch conversion.
- ABS/INC switchable.
- On/off switch.
- Reset/preset.
- Intake scriber: 9 x 9 mm.
- Delivery incl. scriber.
- Power supply: 1 battery type V357.



Item No.	Measuring range/mm	Accuracy mm	Price EUR
906.263	0 - 300	±0.04	276.00
906.264	0 - 450	±0.05	317.00
906.265	0 - 600	±0.05	410.00
Option:			
836.535	Spare battery		1.90
906.118	Scriber 9 x 9 mm		18.30



Mitutoyo digital height and scribing gauges

Ergonomically designed height gauge with data output and a useful hand wheel for both fast and fine adjustment.

- Measuring range: 0- 1000 mm.
- Resolution: 0.005/0.01 mm.
- Accuracy: refer to table.
- ABS/INC switchable.
- Digimatic data output.
- On/off switch.
- Reset/preset.
- Hold function.
- Max. measuring speed: 500 mm/s.
- Reversible measuring direction.
- Fast and fine adjustment.
- Interchangeable scriber, intake 9 x 9 mm.
- Delivery incl. cover and scriber.
- Conforms to factory standard.
- Power supply: 1 battery type V357.



192.663

With a connection for a probe

Item No.	Measuring range/mm	Resolution mm	Accuracy mm	Price EUR
192.663	0- 300	0.005/0.01	±0.02	1,157.00
192.664	0- 600	0.005/0.01	±0.04	1,478.00
192.665	0- 1000	0.005/0.01	±0.06	2,561.00

Options:

836.535	Spare battery	1.90
905.201	Scriber	137.00
105.033	Scriber holder	36.00
192.007	Electronic probe	504.00
192.005	Scribing probe	1,221.00

Without connection for a probe

Item No.	Measuring range/mm	Resolution mm	Accuracy mm	Price EUR
192.613	0- 300	0.005/0.01	±0.02	868.00
192.614	0- 600	0.005/0.01	±0.05	1,191.00
192.615	0- 1000	0.005/0.01	±0.07	2,252.00

Options:

836.535	Spare battery	1.90
107.001	Scriber 9 x 9 mm	53.00
105.033	Scriber holder	36.00



192.613

Mitutoyo Absolute Digimatic height gauges

Ergonomically shaped Mitutoyo Absolute Digimatic HDS digital height gauge with data output. The newly designed base enables easy displacement across a surface plate and provides optimal grip and control. With useful hand wheel this height gauge is just as easy to use as the popular 2-column height gauges. Equipped with locking lever, ideal for use as scribing gauge. The unique Absolute measuring system prevents inaccuracy because of an incorrect zero position. The setting of origin remains as the absolute zero position until the battery has to be changed.

- Measuring range: 0 - 600 mm.
- Resolution: 0.01 mm.
- ABS/INC switchable.
- Digimatic data output.
- On/off switch.
- Reset/preset.
- Hold function.
- Max. measuring speed: any.
- Interchangeable scriber, intake 9 x 9 mm.
- Delivery incl. scriber.
- Weight: 4.6 and 6.4 kg resp.
- Conforms to factory standard.
- Power supply: 1 battery type V357.



*Data cables Digimatic,
USB Input Tool Direct, U-WAVE
available on request.*



570.302

Item No.	Measuring range/mm	Accuracy mm	Price EUR
570.302	0 - 300	±0.03	588.00
570.304	0 - 600	±0.05	1,029.00
Options:			
836.535	Spare battery		1.90
107.001	Scriber 9 x 9 mm		53.00
953.638	Holder for 900.321, clamping shaft ø 6 mm		17.00
900.321	Universal clamp for ø 4 mm, ø 8 mm, dovetail		27.00

Height and scribing gauges with dial and counter

- Measuring range: 0 - 1000 mm.
- Graduation dial indicator: 0.01 mm.
- Resolution counter: 1 mm.
- 1 pointer revolution = 1 mm.
- Rotatable dial.
- Double counter, one indicator in plus direction and one in minus direction.
- Zero setting possible at any height.
- Intake scriber: 9 x 9 mm.
- Delivery incl. scriber.



Item No.	Measuring range/mm	Accuracy mm	Price EUR
906.250	0- 300	±0.04	162.00
906.251	0- 450	±0.05	251.00
906.252	0- 600	±0.05	328.00
906.253	0- 800	±0.06	1,478.00
906.254	0-1000	±0.07	1,610.00
Option:			
906.174	Scriber 9 x 9 mm		18.30



Height and scribing gauges with dial

These height gauges are equipped with a rack, as used for dial calipers.

- Measuring range: 0 - 300 mm.
- Graduation: 0.02 mm.
- 1 pointer revolution = 2 mm.
- Rotatable dial.
- Fine adjustment.
- Delivery in a case with a scriber.



Item No.	Measuring range/mm	Accuracy mm	Price EUR
906.260	0- 150	±0.03	76.00
906.261	0- 200	±0.03	82.00
906.262	0- 300	±0.04	97.00



Height and scribing gauges

- Measuring range: 0 - 1000 mm.
- Vernier: 0.02 mm.
- Fine adjustment.
- Delivery incl. scriber.
From 500 mm with fixed scriber.
- No-glare chrome finished scale and vernier.



Item No.	Measuring range/mm	Accuracy mm	Price EUR
906.325	0 - 200	±0.03	52.00
906.326	0 - 300	±0.04	55.00
906.327	0 - 500	±0.05	94.00
906.328	0 - 1000	±0.07	354.00
Options:			
906.324	Scriber for 906.325/326		12.60
906.329	Scriber for 906.327/328		12.60



Height and scribing gauges with magnifier

To minimize the possibility of reading errors these height gauges are equipped with a magnifier. The magnifier can be adjusted in height, so that it can always be positioned correctly with regard to the vernier.

- Measuring range: 0 - 500 mm.
- Vernier: 0.02 mm.
- Ruler adjustable in height.
- Fine adjustment.
- Intake scriber: 9 x 9 mm.
- Delivery incl. scriber.



Item No.	Measuring range/mm	Accuracy mm	Price EUR
906.255	0 - 300	±0.04	118.00
906.257	0 - 500	±0.05	156.00
Options:			
906.269	Scriber for 906.255		24.00
906.323	Scriber for 906.257		24.00



TESA Micro-Hite/Micro-Hite+M 350/600/900

The TESA Micro-Hite and the TESA Micro-Hite+M (motorized) 350/600/900 are universal height gauges with air cushion for use in the measuring room as well as in the workshop for 1D as well as 2D measurements. Very suitable for accurate internal, external, height, depth and distance measurements of various measuring objects with flat, parallel or cylindrical surfaces. The measuring program in the control unit calculates all relations between the measuring features automatically. 2D measurements can be performed by rotating the work piece 90° (or other known angle) to determine for example bore coordinates, bolt hole circles or angles.

These height gauges distinguish themselves from other height gauges by excellent performance and logical and easy operation using the rotatable and swivelable control unit. The control unit consists of a touchscreen and physical buttons for fast and intuitive operation. Due to the exclusive transport wheel the TESA Micro-Hite and the TESA Micro-Hite+M combine the speed of a manually operated height gauge with the precision and easy handling of a motorized one.

- Measuring range:
350: 365 mm, 600: 615 mm, 900: 920 mm.
- Max. range with standard holder and probe:
350: 520 mm, 600: 770 mm, 900: 1075 mm.
- Max. range with long probe holder:
350: 745 mm, 600: 995 mm, 900: 1300 mm.
- Resolution: 0.0001/0.001/0.01 mm.
- mm/inch conversion.
- Measuring force: 1.6 ± 0.25 N.
- Squareness (frontal):
350: 7 μ m, 600: 9 μ m, 900: 11 μ m
(with IG13 probe resp. 5 μ m, 7 μ m, 9 μ m).
- SCS certificate included.
- Complete stand-alone design, without cable. Ideal for incoming goods inspection and product inspection in a production environment.
- Air cushion for easy displacement on an optional surface plate (see Surface Plates).
- High accuracy in length, straightness and perpendicularity measurements through CAA (Computer Aided Accuracy).
- Fast, easy and reliable probing of the workpiece, in particular with bore measurements, through constant measuring force.
- Optical and acoustic signal to confirm the measuring value.
- Calculations are performed automatically.
- Integrated calculator to perform calculations using measurements.
- Automatic determination of the culmination point with cylindrical surfaces.
- Processing and saving of data through the optional mounted printer, USB stick or via TLC connection to the PC.
- Weight: 350: 33 kg, 600: 37 kg, 900: 45 kg.

- For optional probes and accessories see “Probes and accessories TESA Micro-Hite / TESA-Hite”.

TESA Micro-Hite 350/600/900

- Accuracy: $2 + 2L/1000$ (L in mm).
- Repeatability:
 ≤ 1 μ m (flat surfaces),
 ≤ 1 μ m (cylindrical surfaces).

TESA Micro-Hite+M 350/600/900

- Accuracy: $1.8 + 2L/1000$ (L in mm).
- Repeatability:
 ≤ 0.5 μ m (flat surfaces),
 ≤ 1 μ m (cylindrical surfaces).

NEW

Ask for
the detailed
brochure

 **Schut**



783.505

TESA Micro-Hite/Micro-Hite+M 350/600/900 (continued)

Control unit

The Micro-Hite/Micro-Hite+M height gauges are equipped with a 2D control unit. This fully renewed control unit can be fully controlled using the touch screen, the physical buttons or a combination of both. Standard functions can be accessed with 1 button, making the height gauge accessible to everyone. During measurements the display shows graphical instructions to guide you through the measuring process. Measurements can be saved as a program. Data can be entered on the display for traceability purposes, for instance product or operator information. After completion of the measurements graphs and tables can be shown including go/nogo classification based on entered tolerance values. The adjustable mounting allows for optimal positioning of the control unit.

The control unit features the following interfaces: 3 x USB output, 1 x RS232 output, 1 x TLC output and can be connected to a PC using the de TLC-USB cable or the TLC-TWIN-Cap (wireless). In combination with the Data-Direct software measurements can be exported directly to Excel. Using the STAT-EXPRES SPC software measurements can be saved and analysed. Programs and measuring results can be saved directly to a USB stick. An optional printer allows for printing of the measuring results.

NEW

Ask for
the detailed
brochure



Item No.	Type/description	Price EUR
783.501	Micro-Hite M 350	
783.502	Micro-Hite M 600	
783.503	Micro-Hite M 900	
783.504	Micro-Hite+M 350	
783.505	Micro-Hite+M 600	
783.506	Micro-Hite+M 900	
Options:		
783.301	TESA Link Connector-USB	
783.303	TESA Link Connector-TWIN-Cap	
783.303	USB printer for Micro-Hite	
783.524	Paper for USB printer (4 rolls)	

Basic instrument		Micro-Hite/Micro-Hite+M		
		350	600	900
Measuring range	mm	365	615	920
Max. range with standard holder and probe	mm	520	770	1075
Max. range with long probe holder	mm	745	995	1300
Max. deviation of perpendicularity mech. (frontal)	µm	<7	<9	<11
Max. deviation of perpendicularity with IG13 probe	µm	<5	<7	<9

Basic instruments

The Micro-Hite/Micro-Hite+M height gauges are standard supplied with:

- Micro-Hite(+M) panel with adjustable holder,
- standard probe holder 6 mm (783.511),
- standard probe with carbide ball tip \varnothing 5 mm (782.215),
- reference standard 12.7 mm,
- electric air cushion,
- interchangeable battery (783.512),
- AC adapter and EU cable for adapter,
- SCS calibration certificate.

Probes and accessories TESA Micro-Hite / TESA-Hite

Besides the probes and accessories shown below there are various other types available.

Item No.	Type/description	Price EUR
779.442	Probe holder $l = 75$ mm	•
779.443	Probe holder $l = 150$ mm	•
779.429	Probe holder $l = 25$ mm	•
779.433	TC ball probe $\varnothing 3$ mm	•
779.432	TC ball probe $\varnothing 10$ mm	•
779.435	Barrel-shaped probe $\varnothing 2.2$ mm for thread M3 - M16	•
779.436	Barrel-shaped probe $\varnothing 4.5$ mm for thread M6 - M48	•
779.437	Barrel-shaped probe $\varnothing 9.7$ mm for thread M12 - M150	•
779.438	Disc probe E = 1 mm, D = 4.5 mm	•
779.439	Disc probe E = 2 mm, D = 14 mm	•
779.440	Disc probe E = 3 mm, D = 19 mm	•
779.441	Small probe, cylindrical measuring face $\varnothing 2$ mm	•
780.314	$\varnothing 6$ mm probe, tungsten carbide ball tip, $\varnothing 1$ mm	•
780.315	$\varnothing 6$ mm probe, tungsten carbide ball tip, $\varnothing 2$ mm	•
780.316	$\varnothing 6$ mm probe, tungsten carbide ball tip, $\varnothing 3$ mm	•
779.447	Probe holder with pin with 1 spherical and 1 flat face	•
779.446	Probe holder with cylindrical measuring face $\varnothing 10$ mm	•
783.383	Starter-set	↑
781.906	Partial set	↑
781.474	Complete set	↑

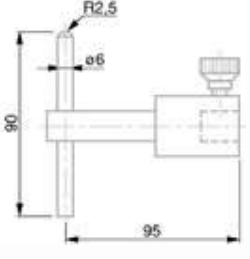
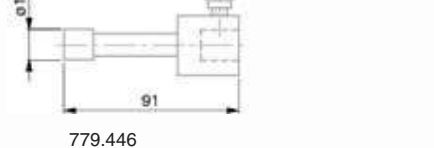
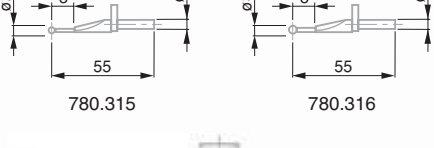
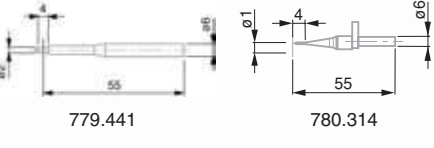
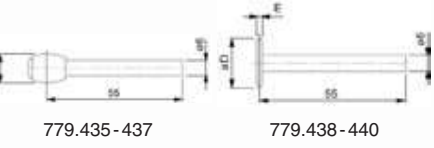
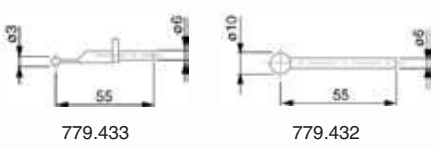
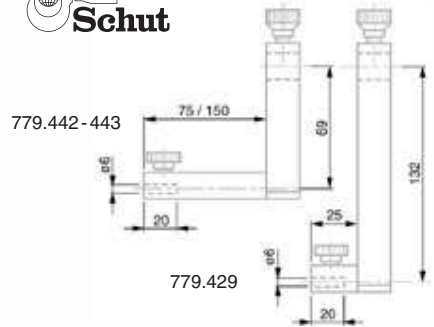

Ask for the detailed brochure

C16.214.EN.20170420

TESA-Hite Plus M 400/700

The TESA Hite Plus M (motorized) 400/700 are universal height gauges for use in the measuring room as well as in the workshop with the best price-performance ratio. The TESA-Hite is equipped with an integrated air cushion for easy movement. The user-friendly, intuitive control unit is very suitable for 1D and 2D measurements, automatic programming of measurement cycles and statistical data processing.

- Measuring range: 405 and 705 mm resp.
- Max. range with standard probe holder: 560 and 860 mm respectively.
- Max. range with long probe holder (782.358): 785 and 1085 mm respectively.
- Resolution: 0.0001/0.001/0.01 mm.
- Accuracy: $\pm(2.5+0.003L)$ μm (L in mm).
- Repeatability: $\leq 1 \mu\text{m}$ (flat surfaces), $\leq 2 \mu\text{m}$ (bores).
- Easy-to-read LCD-display.
- RS232C data output.
- Integrated air cushion.
- Max. measuring speed: 600 mm/s (manual) and 40 mm/s (motorized).
- Measuring force: 1 N.
- Squareness (frontal): 8 and 12 μm resp.
- Operating temperature: 10 to 40°C.

- Weight: 779.046: 27 kg, 779.047: 32 kg.
- Protection: IP40, control panel: IP65.
- For optional probes and accessories see "Probes and accessories TESA Micro-Hite / TESA-Hite".



Ask for
the detailed
brochure



779.046

779.047

Item No.	Type/description	Price EUR
Without built-in printer:		
779.046	TESA-Hite Plus M 400	
779.047	TESA-Hite Plus M 700	
With built-in printer:		
779.048	TESA-Hite Plus M 400	
779.049	TESA-Hite Plus M 700	
Options:		
782.006	RS232C cable	
782.972	Interface for measuring squareness	

Standard accessories

The TESA-Hite Plus M 400/700 height gauges are standard supplied with:

- standard probe holder (781.618),
- TC ball probe $\phi 5$ mm (782.215),
- reference standard 6.35 mm,
- electric pump,
- rechargeable battery pack (782.754),
- AC adapter (782.201) incl. power cable (782.202),
- SCS calibration certificate.

TESA-Hite Magna / TESA-Hite 400/700

The TESA-Hite height gauges are, thanks to the easy and robust configuration, very suitable for use in workshop conditions to measure heights, grooves, bores, bore distances and parallelism, with a constant measuring force.

The TESA-Hite Magna is the vertical height gauge with the best price-performance ratio. Because of the user-friendly operation with the function keys, measuring values are displayed quick and reliable. The TESA-Hite is because of the high accuracy and exclusive designed measuring system very suitable to measure parallelism and perpendicularity.

The height gauges are equipped with a stable cast iron base. The TESA-Hite also has an integrated air cushion for easy movement.

- Measuring range: 415 and 715 mm resp.
- Max. range with standard probe holder: 570 and 870 mm resp.
- Max. range with long probe holder (782.358): 795 and 1095 mm resp.

- Easy-to-read LCD-display.
- RS232C data output.
- Measuring force: 1.5 ± 0.5 N.
- Optionally the TESA SPC printer can be used for statistical calculations (see Printer TESA).
- For optional probes and accessories see "Probes and accessories TESA Micro-Hite / TESA-Hite".



TESA-Hite Magna 400/700

Equipped with the unique *magna* μ measuring system.

- Resolution: 0.001/0.005/0.01 mm.
- Accuracy: ± 8 μ m.
- Repeatability: ≤ 3 μ m (flat surfaces), ≤ 5 μ m (bores).
- Weight: 782.947: 15 kg, 782.948: 18 kg.
- Protection: IP55, control panel: IP65.

TESA-Hite 400/700

Measuring with higher accuracy, also for measuring perpendicularity. Air cushion pump for easy movement on a surface plate.

- Resolution: 0.0001/0.001/0.01 mm.
- Accuracy: $\pm (2.5 + 0.004L)$ μ m (L in mm).
- Repeatability: ≤ 2 μ m (flat surfaces), ≤ 3 μ m (bores).
- Squareness (frontal): 9 and 13 μ m resp.
- Weight: 782.840: 27 kg, 782.841: 32 kg.
- Protection: IP40, control panel: IP65.

Standard accessories

The TESA-Hite Magna / TESA-Hite 400/700 is standard supplied with:

- standard probe holder (781.618),
- TC ball probe $\phi 5$ mm (782.215),
- reference standard 6.35 mm,
- electric pump (Hite),
- rechargeable battery pack (782.754),
- AC adapter (782.201) incl. power cable (782.202),
- SCS calibration certificate.

Item No.	Type/description	Price EUR
782.947	TESA-Hite Magna 400	
782.948	TESA-Hite Magna 700	
782.840	TESA-Hite 400	
782.841	TESA-Hite 700	
Options:		
782.006	RS232C cable	
782.972	Interface for measuring squareness	

Mitutoyo CNC height gauges Linear Height LH-600 E/EG

The integration of CNC technology in this height gauge enables fully automated measurements with a fixed measuring speed and measuring force. This ensures the best possible accuracy and repeatability.

An air-bearing of the base (with built-in compressor) allows almost feather-light movement on a surface plate. Equipped with the unique “semi-floating”, ideal for scanning purposes, for example to find a maximum value.

The control panel is an illuminated graphical 5.7" TFT LCD color display with alphanumeric keys and a parallel printer port. The Linear Height has 21 (measuring) functions, motorized probe movement, memory space for 50 programs and 60 000 measurements which can be statistically processed. The most occurring measurements can be done by pressing a button.

A special and fully automated measuring program for squareness checks is included. By connecting an external Digimatic dial indicator, both squareness and position can be measured at the same time.

- Excellent accuracy and a special measuring system with a 0.1 μm resolution.
- Automatic repeat of measuring programs saved with the learning function.
- Direct display of Go/NoGo tolerance judgement after every measurement.
- Data entry from a Digimatic instrument.
- Total freedom of movement due to the built-in battery and compressor.
- Easy operation because of the very low weight.
- Clear and conveniently laid out graphical color display with numeric and alphanumeric keys.
- Intern memory for measurement values and measuring programs; optional external data storage with a USB stick.
- Direct printing of measurement values on an external printer.
- Delivery with an inspection report.

Item No.	Type	Price EUR
518.351	LH-600 E	
518.352	LH-600 EG	

LH-600 standard accessories

The Mitutoyo Linear Height is standard supplied with:

- probe holder including excentric ball probe $\varnothing 5$ mm,
- block for probe diameter calibration,
- rechargeable Ni-MH battery,
- control panel 1D/2D,
- AC adapter,
- dust cover.



 Schut

Ask for
the detailed
brochure

518.352

Mitutoyo Linear Height LH-600 E/EG (continued)

The control panel of the Linear Height LH-600 is an illuminated graphical color display with alphanumeric keys and a parallel printer port. This 1D/2D panel enables measurements in 1 or 2 coordinates for height measurements, diameter measurements of bores and axes, flatness, straightness, perpendicularity (in combination with an optional Digimatic dial indicator) and various calculations with the measured values of the various shapes. The measured values can be processed for the basic statistical data and a histogram.

- Measuring range: 0 - 600 mm.
- Max. measuring height: 972 mm.
- Resolution: 0.0001/0.001/0.01/0.1 mm.
- Accuracy:
($1.1 + 0.001L$) μm (L in mm).
- Repeatability:
flat 0.0004 mm, bore 0.0009 mm.
- USB/RS232C data output.
- Max. measuring speed: 5 - 40 mm/s.
- Measuring force: 1 N.
- Squareness: 0.005 mm.
- Straightness: 0.004 mm.
- Weight: 24 kg.
- Power supply: AC adapter 230 Vac and built-in rechargeable Ni-MH battery (approx. 5 hours operating time).

- Many display languages, such as English, Dutch, German and French.



Mitutoyo LH-600 / QM-Height accessories



1D measurements

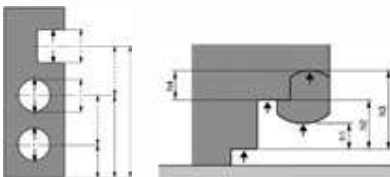

2D measurements

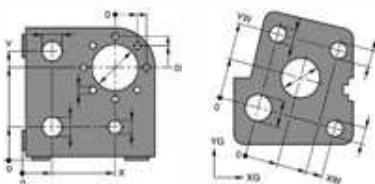

Item No.	Description	Price EUR
120.793	Long probe holder	
120.792	Dial indicator holder ($\varnothing 8$ mm)	
957.261	Ball probe $\varnothing 2$ mm coaxial	
957.262	Ball probe $\varnothing 3$ mm coaxial	
957.263	Ball probe $\varnothing 4$ mm coaxial	
120.788	Excentric ball probe $\varnothing 4$ mm	
120.789	Excentric ball probe $\varnothing 6$ mm	
957.264	Disc probe $\varnothing 14$ mm	
957.265	Disc probe $\varnothing 20$ mm	
120.136	Cylindrical probe $\varnothing 10$ mm with holder	
226.117	Shank for Renishaw M2-threaded probes	
226.118	Shank for Renishaw M3-threaded probes	
120.072	Depth probe	
120.073	Conical probe $\varnothing 20$ mm	
121.050	Thermal printer (230 Vac) (LH-600 E/EG)	
121.052	Thermal printing paper, 10 rolls	
120.712	Extra battery for LH-600	

Mitutoyo height gauges QM-Height 350/600

The Mitutoyo QM-Height height gauge, equipped with the highly accurate Absolute linear encoder, delivers mature performance in combination with affordability. The high accuracy, repeatability and perpendicularity make the QM-Height very suitable to satisfy your most critical measurement needs. Yet the lightweight, compact design and the simplicity of the controls make this a user-friendly and flexible height gauge, suitable for use in both cleanroom and workshop. All measuring functions can be started by pressing just one button.

The QM-Height is equipped with many advanced measuring functions for measuring height, inside and outside diameters, min/max values and center distances. It is also equipped with a scanfunction, data-output, measuring memory and a Go/NoGo tolerance judgement, making human interpretation errors almost impossible. The QM-Height is available in two measuring ranges and Mitutoyo offers a wide range of accessories. See for all accessories "Mitutoyo LH-600 / QM-Height accessories".

- Measuring range: 0 - 600 mm.
- Resolution: 0.001/0.005 mm.
- Accuracy: $\pm(2.4 + 2.1L/600)$ μm (L in mm).
- Repeatability: 0.0018 mm.
- USB and Digimatic data output.
- Direct Go/NoGo tolerance judgement by LEDs after every measurement (also on display).
- An air-bearing of the base (with built-in compressor) allows almost feather-light movement on a surface plate.
- Measuring force: 1.5 ± 0.5 N.
- Operating temperature: 0 to 40°C.
- Adjustable tolerance limits.
- Weight: 518.230: 25 kg, 518.232: 26 kg, 518.234: 29 kg, 518.236: 30 kg.
- Delivery with an inspection report.
- Power supply: 4 batteries type AA or optional AC adapter.

*Data cables Digimatic,
USB Input Tool Direct, U-WAVE
available on request.*



Item No.	Measuring range/mm	Squareness μm	Price EUR
Without air floating:			
518.230	0-350	7	
518.232	0-600	12	
With air floating:			
518.234	0-350	7	
518.236	0-600	12	
Options:			
106.180	AC adapter		
495.111	Spare battery (4 needed)		

Standard accessories:

- auxiliary grip,
- block for probe diameter calibration,
- probe holder including eccentric ball probe $\varnothing 5$ mm,
- 4 batteries.

Granite surface plate with stand for height gauges

Correct and accurate use of height gauges demand a robust and flat working table. Especially in combination with the very advanced and accurate Mitutoyo and TESA height gauges this is a necessity in order to benefit the full potential of these instruments.

In combination with the purchase of a TESA or Mitutoyo height gauge, Schut Geometrical Metrology offers granite surface plate and stand sets in various dimensions and accuracy classes for very competitive prices. Combinations that make the purchase of one of these height gauges even more attractive!

NEW

Digital protractor

Compact digital protractor to attach to a caliper or height gauge.

- Measuring range: 180°.
- Resolution: 0.01° or 1'.
- Accuracy: ±5'.
- Digimatic data output.
- On/off switch.
- Automatic switch-off (adjustable).
- Preset or hold function.
- Reset.
- Reversible measuring direction.
- Weight: 160 g.
- Delivery in a case including assembly key, mounting bracket (clamping shaft 9 x 9 mm) and clamping screw for height gauge.
- Power supply: 2 batteries type AAA.



Item No.	Description	Price EUR
855.803	Digital protractor	457.00
Options:		
497.914	Spare battery (2 needed)	0.40
905.338	Digimatic cable, 1 m	30.00
905.409	Digimatic cable, 2 m	36.00

The stands are very robust and the Support of the surface plate is determined on the basis of the Bessel points. All sets are available in surface plate sizes from 630 x 630 mm up to 2000 x 1000 mm, all according DIN 876, accuracy classes 1, 0 en 00.

Check our website www.Schut.com for the most recent promotions and prices.



131.101 +
131.113 +
131.108 +
402.028

With the purchase of a height gauge:

UNIQUE SET PRICES

Surface plate 1000 x 630 x 150 mm, class 0 including **stand**: **EUR 960.00**

Surface plate 1000 x 630 x 150 mm, class 0 including **stand, slide protection, cover, chest of drawers and cleaner**: **EUR 1,350.00**

Delivery ex Groningen, Netherlands

Surface plate cleaner

Surface plate cleaner for granite surface plates. Rubbing in the cleaner dissolves any flaws on the plate's surface. Dust, dirt, grease stains, finger and hand prints will disappear.



Item No.	Description	Price EUR
407.303	Cleaner, 500 ml	7.00

Hardness testers / Thickness gauges / Thermometers
Tachometers / Dynamometers / Inspection instruments



Portable Shore hardness testers

Portable hardness testers to measure Shore hardness A or D, according to DIN ISO 7619-1, ISO 868 and ASTM D 2240.

- Measuring range: 0-100 Shore.
- Analog: graduation 1 Shore, digital: resolution 0.1 Shore.
- Measuring length: 2.5 mm.
- Material thickness: ≥ 6 mm.
- Delivery in a case.



909.066

Analog

- Dial diameter: 57 mm.
- Dimensions: 110 x 58 x 30 mm.
- Weight: 230 g.

Digital

Integrated sensor and equipped with comfortable buttons. Possibility for display of current, average and maximum measuring value.

- Accuracy: ± 1 Shore.
- RS232C data output.
- On/off switch.
- Automatic switch-off.
- Max function.
- Calculation of the average of at most 9 measurements in "max mode".
- Dimensions: 161 x 65 x 28 mm.
- Power supply: 4 batteries type AAA.



Item No.	Type	Meas. range/Shore	Price EUR
Analog:			
907.882	Shore A	20 - 90	140.00
907.889	Shore D	20 - 90	136.00
Digital:			
909.066	Shore A	0 - 100	301.00
909.068	Shore D	0 - 100	352.00
Options:			
497.914	Spare battery (4 needed)		0.40
909.078	RS232C cable and software		82.00
909.430	Shore A (30 x 90) test block set 50 x 50 x 7 mm		95.00
909.431	Shore D (30 x 90) test block set 50 x 50 x 7.5 mm		61.00



907.882



909.430



909.431

Type	Shore A	Shore D
Max. spring force	8.065 N	44.50 N
Impact module		
Applications	Soft rubber, elastomers, nature rubber, etc.	Hard rubber, thermoplastics, etc.

Hildebrand portable Shore hardness testers



Portable hardness testers to measure Shore hardness A or D, according to DIN ISO 7619-1, ISO 868 and ASTM D 2240.

- Measuring range: 0- 100 Shore.
- Graduation: 1 Shore.
- Accuracy: ± 0.5 Shore.
- Measuring length: 2.5 mm.
- Material thickness: ≥ 6 mm.
- With or without extra pointer for maximum measuring value indication.
- Dial diameter: 57 mm.
- Total length: 121 mm.
- Weight: 184 g.
- Delivery in a case with a declaration of conformity.
- 2 year factory guarantee.



856.005



Type	Shore A	Shore D
Max. spring force	8.065 N	44.50 N
Impact module		
Applications	Soft rubber, elastomers, nature rubber, etc.	Hard rubber, thermoplastics, etc.

Item No.	Type	Price EUR
856.005	Shore A	428.00
856.006	Shore D	428.00
With maximum value indication:		
856.007	Shore A	490.00
856.008	Shore D	490.00

Measuring stand for Hildebrand Shore hardness testers

To increase the accuracy and repeatability of the measurements, the use of this stand is recommended. It prevents possible errors that can occur by differences in the pressing force or when the hardness tester is not held up right.

- Max. measuring height: 180 mm.
- Measuring table: $\varnothing 98$ mm.
- Standard equipped with a weight (1000 g) for Shore A.
- Load weight: Shore A: 274 g,
Shore D: 4000 g.
- Stable aluminum construction, table of stainless steel.
- Weight: 16.4 kg.

Item No.	Description	Price EUR
856.010	Measuring stand	1,028.00
Options:		
856.011	Weight for Shore A	43.00
856.012	Weight for Shore D	153.00
856.028	Set of setting standards (20, 40, 60 and 80 Shore)	196.00



856.012

856.011

856.028

856.010

Portable hardness testers

For measuring the hardness of various materials like aluminum, copper, brass and soft steel. Fit for various forms like extrusion profiles, tubes and flat materials.

- Measuring range: 0-20 Webster.
Values to convert by means of graph (Rockwell B or E Scale).
- Material thickness: 0.4-6 mm.
- Round anvil: $\varnothing 3/8"$.
- Delivery in a case incl. spare penetrator, screwdriver, adjusting wrench, standard test strip and manual.

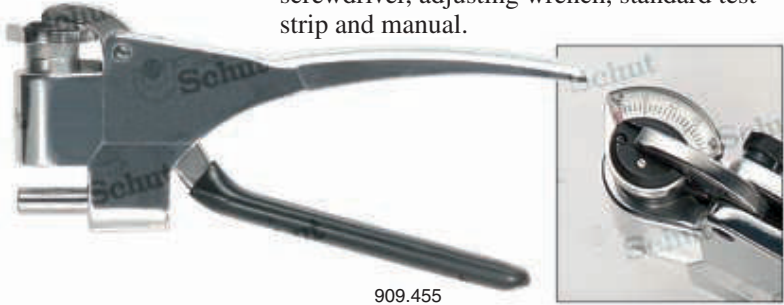
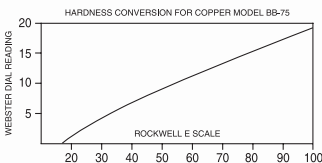
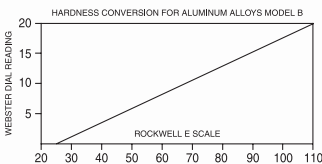
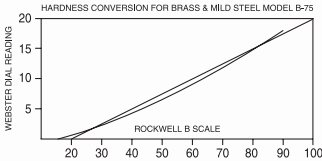

Item No.	Rockwell	Material	Price EUR
909.455	E25 - E110	aluminum	1,056.00
909.456	B25 - B100	brass, hard	1,056.00
909.457	E20 - E100	aluminum, soft steel copper	1,056.00

Portable digital hardness tester

This Swiss made quality product allows one to determine HRC hardness in the most simple way. Modern technology resulted in an extremely compact and easy to use tool. No switches, buttons or cables, simply pull up the ring, measure and immediately read out the value. The measurement causes hardly any damage to the product. Especially suitable for larger objects, installed machines and use in hard-to-reach places.

- Measuring range: 20-70 HRC.
- Resolution: 0.1 HRC.
- Accuracy: ± 1.0 HRC.
- Automatic switch-off.
- Operating temperature: 5 to 50°C.
- Dimensions: $\varnothing 12 \times 140$ mm.
- Weight: 36 g.
- Power supply: 2 batteries type V394.

Requirements

- Solid base (at least 5 kg) for objects < 5 kg.
- Minimum thickness of objects: 3 mm.
- Minimum thickness of a hardened top layer, if any: 0.7 mm.
- Minimum diameter of workpiece: 10 mm.
- Minimum radius of spherical measuring surface: 30 mm.



Item No.	Description	Price EUR
774.075	Digital hardness tester	1,060.00
Option:		
420.248	Spare battery (2 needed)	1.30

Portable digital hardness testers

- Measuring range:
HLD 200 - 890, HB 30 - 655,
HRC 13.5 - 95.3, HV 80 - 976,
HRB 46.5 - 101.7, HSD 26.4 - 99.5.
- Accuracy: ±0.5% (at HLD 800).
- On/off switch, automatic switch-off.
- Storage for 1250 measuring values.
- Min. radius: 30 mm.
- Tungsten carbide stylus tip.
- ASTM A956.
- Delivery with an inspection report.

Digital hardness tester (909.470)

- RS232C data output.
- Operating temperature: -20 to 50°C.
- Dimensions basic instrument: 108 x 62 x 25 mm.
- Weight basic instrument: 230 g.



NEW



Item No.	Description	Price EUR
909.470	Digital hardness tester	1,516.00
909.485	Digital hardness tester	1,673.00
Options:		
909.477	Set special support rings	299.00
909.478 ¹	Testblock D, 2.5 kg	167.00
909.479 ¹	Testblock G, 5.5 kg	368.00
Options (only for 909.470):		
497.914	Spare battery (2 needed)	0.40
909.480	Printer	230.00
270.732	Printing paper (5 rolls)	29.00
909.471	Ext. impact module D	732.00
909.472	Ext. impact module G	1,359.00
909.473	Ext. impact module C	732.00
909.474	Ext. impact module DL	1,777.00
909.481	Cable for ext. impact module	115.00

¹ Delivery with an inspection report.

Selection table materials for impact module D

Material	HLD	HRC	HRB	HB (30D ²)	HSD	HV
bright steel	300-890	19.8-68.5	59.6- 99.6	80-651	26.4-99.5	83-976
tool steel	300-840					80-898
stainless steel	300-800	20.4-67.1		85-655		85-802
gray cast iron	444-650		46.5-101.7	140-334 (30D ²)		
cast iron	416-658	19.6-62.4		140-384 (30D ²)		
cast aluminum	200-560			30-159 (10D ²)		
brass	200-550	13.5-95.3		40-173 (10D ²)		
bronze	300-700			60-290 (10D ²)		
copper	200-690			45-315 (10D ²)		

- Delivery in a case with RS232C-USB adapter, software and cable, small supporting ring, test block, impact module D (909.471) and leather wrist strap.
- Power supply: 2 batteries type AAA.

Digital hardness tester (909.485)

- With integrated impact module D.
- USB data output.
- Operating temperature: -20 to 40°C.
- Dimensions basic instrument: 158 x 41 x 26 mm.
- Weight basic instrument: 120 g.
- Delivery in a case with AC adapter/charger, software and cable, small supporting ring, test block and integrated impact module D.
- Power supply:
1 rechargeable battery 3.7 V.
- AC adapter/charger.



Portable digital hardness testers (continued)

Optional impact devices

External impact module D

External module, instead of standard module.

External impact module DL

With thin, long probe on the impact module for measuring in grooves, blind bores etc.

External impact module C

4x reduced impact energy for hardened components, thin-walled materials and coatings.

External impact module G

9x higher impact energy for rough casting pieces etc.

NEW

Impact devices	D	DL	C	G
Max. roughness (Ra)	2	2	0.4	7
Impacting energy (Nmm)	11	11	3	90
Mass of impact body (g)	5.5	7.8	3.0	20
Impact body length (mm)	147	250	141	254
Max. hardness of workpiece (HV)	940	940	1000	–
Max. hardness of workpiece (HB)	–	–	–	650
Min. weight of sample:				
of compact shape (kg)	5	5	1.5	15
on solid support (kg)	2	2	0.5	5
coupled on plate (kg)	0.1	0.1	0.02	0.5
Min. thickness of sample:				
coupled (mm)	3	3	1	10
min. thickness of hardened layers (mm)	0.8	0.8	0.2	–



909.471



909.472



909.473



909.474

Impact bodies

Item No.	Description	Price EUR
909.482	Impact body D	115.00
909.483	Impact body G	230.00
909.564	Impact body C	115.00
909.484	Impact body DL	460.00



909.477



Set special support rings

The set consists of

Type	Description
①	Cylindrical outside surface R10 - R15
①	Cylindrical outside surface R14.5 - R30
①	Cylindrical outside surface R25 - R50
②	Cylindrical inside surface R11 - R13
②	Cylindrical inside surface R12.5 - R17
②	Cylindrical inside surface R16.5 - R30
③	Spherical outside surface SR10 - SR15
③	Spherical outside surface SR14.5 - SR30
③	Spherical outside surface SR11 - SR13
④	Spherical inside surface SR12.5 - SR17
④	Spherical inside surface SR16.5 - SR30
⑤	Cylindrical outside surface, radius adjustable $\geq R10$

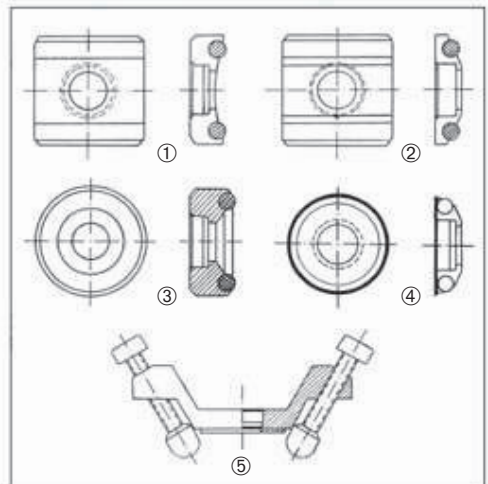

Portable digital hardness tester

With this portable hardness tester one can easily measure the hardness of installed machines or steel constructions, in hard-to-reach places, of heavy and large objects and for example for inspection of large series in the production process. The most common hardness scales can be measured and read out directly on the screen.

- Measuring range with impact module D:
 - HLD 200-900, HB 30 -650,
 - HRC 20- 68, HV 80 -940,
 - HRB 20-100, HSD 32.5- 99.5.
- Accuracy: $\pm 0.8\%$ (at HLD 800).
- On/off switch, automatic switch-off.
- Storage for 500 measuring values.
- Calculates automatically the average of at most 7 measuring values.
- Min. radius: 30 mm.
- Operating temperature: 0 to 45°C.
- Admissible relative humidity: <90%.
- Dimensions basic instrument: 170 x 68 x 30 mm.
- Weight basic instrument: 250 g.
- Delivery including:
 - integrated impact module D,
 - test block HLD 2.5 kg,
 - 2 batteries.
- ASTM A956.
- Delivery with an inspection report.
- Power supply: 2 batteries type AAA.

External impact module G

9x higher impact energy for rough casting pieces etc.

External impact module C

4x reduced impact energy for hardened components, thin-walled materials and layers on a surface.

External impact module DL

With thin, long probe on the impact module for measuring in grooves, blind bores etc.

External impact module D

External module, instead of standard module.



Item No.	Description	Price EUR
906.804	Digital hardness tester	1,516.00
Options:		
497.914	Spare battery (2 needed)	0.40
906.816	Ext. impact module G	1,285.00
906.813	Ext. impact module C	507.00
906.817	Ext. impact module DL	1,285.00
906.812	Ext. impact module D	507.00
906.834 ⁴	Test block HLD 2.5 kg	105.00

⁴ Delivery with an inspection report.

Requirements

Impact module	Min. weight workpiece/kg ¹	Min. weight workpiece/kg ²	Min. thickness/mm object	Min. thickness/mm hardened top layer ³	Max. roughness Ra/ μm
C	0.5	1.5	1	0.2	0.4
D/DL	2	5	5	0.8	1.6
G	5	15	10	–	6.3

¹ On a solid base of at least 5 kg.

² Without solid base.

³ Minimum thickness of a hardened top layer, if any.

Selection table materials for impact module D/DL

Material	HLD	HRC	HRB	HB (30D ²)	HSD	HV
bright steel	300-900	20.0-68.0	38.4- 99.5	80-647	32.5-99.5	80-940
tool steel	300-840	20.4-67.1				80-898
stainless steel	300-800	19.6-62.4	46.5-101.7	85-655		85-802
gray cast iron	400-660			131-387		
cast iron	360-650			90-334		
cast aluminum	200-560			30-160 (10D ²)		
brass	200-550		20.0- 95.3	40-173		
bronze	300-700			60-290		
copper	200-690			45-315		



Digital thickness gauge

This thickness gauge measures non-destructively the thickness and speed of sound from several materials according to the ultrasonic measuring principle (as illustrated).

- Measuring principle: ultrasonic.
- Measuring range for steel: 1.2 - 200 mm.
- Resolution: 0.1 mm.
- Accuracy: $\pm(0.5\%H+0.1 \text{ mm})$
(H = measured value).
- Measuring frequency: 5 MHz.
- Speed of sound: 1000 - 9000 m/s.
- mm/inch conversion.
- RS232C data output.
- On/off switch.
- Automatic switch-off.
- 11 presets for the speed of sound of various materials (cd01 - cd11) and one configurable speed of sound (cd12).

- Calibration standard on side of basic instrument.
- Operating temperature: 0 to 50°C.
- Admissible relative humidity: <80%.
- Dimensions: 120 x 60 x 30 mm.
- Weight basic instrument: 260 g.
- Power supply: 4 batteries type AAA.

Test block for calibration (909.398)

For the inspection and calibration of digital thickness gauges.

- Heights: 2.5 - 25 mm, incr. 2.5 mm.
- Tolerance: 0.1 mm (flatness: $\pm 0.05 \text{ mm}$).
- Material: steel.

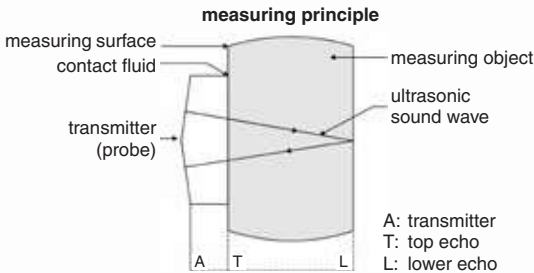

Delivery including:

- small, rectangular probe (measuring face $\varnothing 10 \text{ mm}$),
- contact fluid,
- manual,
- 4 batteries.



Preset code	Material
cd01	steel
cd02	cast iron
cd03	aluminum
cd04	copper (red copper)
cd05	brass
cd06	zinc
cd07	quartz glass
cd08	polyethylene
cd09	PVC
cd10	gray cast iron
cd11	nodular/ductile cast iron

Item No.	Description	Price EUR
909.139	Thickness gauge	311.00
Options:		
497.914	Spare battery (4 needed)	0.40
909.075	RS232C cable and software	82.00
909.576	Contact fluid (approx. 75 ml)	13.00
909.398	Test block for calibration	146.00

909.398



Digital thickness gauges

This thickness gauge measures non-destructively the thickness and speed of sound from several materials according to the ultrasonic measuring principle. The Echo-Echo model is capable of measuring the material thickness even through coatings.

- Resolution: 0.1 mm or 0.01 mm.
- Accuracy (H = measured value):
 - 0.65 - 9.99 mm: ± 0.04 mm,
 - 10.00 - 99.99 mm: $\pm (0.1\%H + 0.04)$ mm,
 - 100.0 - 400.0 mm: $\pm 0.3\%H$.
- Measuring frequency: 5 MHz (standard probe).
- 9 preset materials (aluminum, titanium, steel, stainless steel, glass, copper, cast iron, brass and polystyrene) and one configurable speed of sound.
- mm/inch conversion.
- LCD display with backlight.
- On/off/reset switch.
- Automatic switch-off.
- Calibration standard on side of basic instrument.
- Operating temperature: -20 to 50°C.
- Dimensions: 116 x 64 x 27 mm.
- Weight basic instrument: 220 g.
- Delivery including inspection report (standard probe).
- Delivery including contact fluid.
- Power supply: 2 batteries type AAA.

Standard model

- Measuring range: 0.8 - 300 mm (standard probe).
- Delivery including standard probe (909.570).

Echo-Echo model

Echo-Echo mode is only available with the standard probe, 909.575.

- Measuring range:
 - normal mode: 1.44 - 200 mm (standard probe),
 - Echo-Echo mode: 3 - 25 mm (standard probe).
- Maximum coating thickness: 2 mm.
- Delivery including standard probe (909.575).

Models with USB output only

- Tolerance settings with alarm function.
- Memory for 5000 measurements.
- Delivery including software and cable.



Item No.	Description	Price EUR
Thickness gauges:		
909.566	Without USB data output	759.00
909.567	With USB data output	884.00
Echo-Echo model:		
909.568	Without USB data output	1,258.00
909.569	With USB data output	1,383.00
Options:		
497.914	Spare battery (2 needed)	0.40
909.576	Contact fluid (approx. 75 ml)	13.00
909.398	Test block for calibration	146.00

Optional probes

Item No.	Mode	Measuring range/mm	Measuring frequency MHz	Minimum tube diameter/mm	Price EUR
909.570		0.8 - 300	5	$\varnothing 20 \times 1.2$	153.00
909.572		0.65 - 20	10	$\varnothing 10 \times 4.0$	262.00
For Echo-Echo model only:					
909.575	Normal	3.0 - 25	5	$\varnothing 25 \times 3$	327.00
	Echo-Echo	1.44 - 200			

Test block for calibration (909.398)

For the inspection and calibration of digital thickness gauges.

- Heights: 2.5 - 25 mm, incr. 2.5 mm.
- Tolerance: 0.1 mm (flatness: ± 0.05 mm).
- Material: steel.

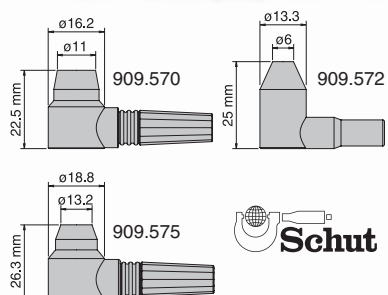

Digital coating thickness gauges

Measurements of coating thickness of paint, coating, foil etc. (non-magnetic layers) on a magnetic (ferro) and/or non-magnetic (non-ferro) metal substrate. Available with integrated or external sensor, in single or combined (automatically selecting magnetic/non-magnetic) model. Furthermore there is a one-button model, specifically designed for the automobile industry.

- Measuring principles: magnetic induction (ferro) and eddy current (non-ferro).
- Measuring range: 0 - 1250 μm .
- Resolution: 0.1 μm (< 100 μm),
1 μm (\geq 100 μm).
- Accuracy: $\pm 3\%H$ or 3 μm (H = measured value).
- $\mu\text{m}/\text{mil}$ conversion.
- RS232C data output.
- Automatic switch-off.
- Minimum measuring area: 6 x 6 mm.
- Minimum substrate thickness: 0.3 mm.
- Minimum object radius:
ferro: 1.5 mm (convex), 25 mm (concave),
non-ferro: 3 mm (convex), 50 mm (concave).
- Dimensions: 131 x 65 x 28 mm.
- Delivery in a case with ferro and non-ferro base plate and reference standards.
- Power supply: 4 batteries type AAA.



909.070

909.072



Item No.	Type/description	Price EUR
With integrated sensor:		
909.060	Ferro	301.00
909.069	Non-ferro	347.00
909.070	Non-ferro and ferro	408.00
With external sensor:		
909.061	Ferro	311.00
909.071	Non-ferro	347.00
909.072	Non-ferro and ferro	408.00
One-button model:		
909.062	Non-ferro and ferro	417.00
Options:		
497.914	Spare battery (4 needed)	0.40
909.073	RS232C cable and software	82.00



909.062

Digital coating thickness gauge

Measurements of coating thickness of paint, coating, foil etc. (non-magnetic layers) on a magnetic (ferro) and non-magnetic (non-ferro) metal substrate.

- Measuring principles: magnetic induction (ferro) and eddy current (non-ferro).
- Measuring range: 0- 1300 μm .
- Resolution: 1 μm (0- 999 μm),
10 μm (1000- 1300 μm).
- Accuracy: $\pm(3\% + 2 \mu\text{m})$.
- Statistics: number of measurements, mean, minimum, maximum and standard deviation.
- $\mu\text{m}/\text{mil}/\text{mm}$ conversion.
- USB data output.
- Illuminated LED display.
- On/off switch.
- Automatic switch-off.
- Minimum measuring area: $\varnothing 6 \text{ mm}$.
- Minimum substrate thickness:
ferro: 0.5 mm, non-ferro: 0.3 mm.
- Minimum object radius:
1.5 mm (convex), 25 mm (concave).
- Maximum measuring frequency: 2 times per second.
- Adjustable tolerance limits (alarm signal on display and acoustic).
- Operating temperature: 0 to 40°C.
- Admissible relative humidity: 20-90%.
- Dimensions: 110 x 53 x 24 mm.
- Weight: 92 g.
- Delivery in a case with USB cable, software, ferro and non-ferro base plate, reference standards and an inspection report.
- Power supply: 2 batteries type AAA.

NEW



Item No.	Description	Price EUR
909.116	Coating thickness gauge	231.00
Option:		
497.914	Spare battery (2 needed)	0.40

Digital thermometer

- Measuring range: -50 to 750°C.
- Resolution: 1°C.
- Accuracy (H = measured value):
 - 50 to -20°C: ±4°C,
 - 20 to 0°C: ±3°C,
 - 0 to 750°C: ±(0.75%H+1°C).
- On/off switch.
- Hold function.
- Delivery incl. TP01 probe (909.076).
- Weight (incl. battery): approx. 150 g.
- Power supply: 1 battery type PP3 (9 V).



Item No.	Measuring range/°C	Price EUR
909.145	-50 to 750	30.00
Option:		
495.161	Spare battery	1.50

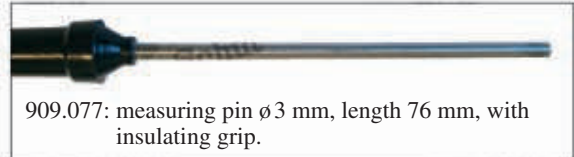

Item No.	Type	Measuring range/°C	Applications	Material probe	Price EUR
909.076	TP01	-50 to 204	air	steel	5.40
909.077	TP02	-50 to 700	air, steam, liquids	stainless steel	5.90

Contact thermometers

Temperature fluctuations can have a major influence on the precision of products and measuring instruments that have to be manufactured. This thermometer has a very good heat transmission, allowing you to measure the exact temperature of a product within a few minutes.

- Measuring range: 16-26°C.
- Accuracy:
 - 633.250: between 18 and 22°C: ±0.1°C,
 - 633.251: between 17 and 23°C: ±0.1°C.



Item No.	Measuring range/°C	Graduation °C	Total length (incl. base)/mm	Dimensions base l x w x h/mm	Weight kg	Price EUR
633.250	16-26	0.2°C	113	12 x 12 x 28	0.03	161.00
633.251	17-23	0.1°C	100	10 x 10 x 25	0.025	94.00

Infrared thermometers

These hand-held infrared thermometers are extremely suitable for fast non-contact temperature measurements. Equipped with laser for easy aiming at the object. With adjustable emissivity for different surfaces. Applications: for example in the food, automotive and chemical industries, in the process technology and for research purposes.

- Measuring range: -60 to 760°C.
- Resolution: 0.1 or 0.2°C.
- Accuracy: $\pm 2^\circ\text{C}$ or $\pm 2\%$.
- °C/°F conversion.
- Emissivity preset (standard 0.95).

- Automatic switch-off.
- Hold function.
- Min/max function.
- Operating temperature: 0 to 50°C.
- Measuring time: 1000 ms.
- Laser: 635 - 660 nm, class 2.

Models

The infrared thermometers have different optics ratios, which makes them applicable for different working distances:

- 908.800: for measurements at small distances,
- 909.413: with a fixed small working distance and a dual laser pointer for targeting,
- 909.412: for measurements at large distances or with a large temperature range.



908.800



909.413



909.412



Material	T/°C	Emissivity
Cement	0 - 200	0.96
Cloth	93	0.90
Paper	38 - 371	0.93
Granite	21	0.45
Steel	25	0.65
Cast iron	100	0.21
Cold milled steel	93	0.75 - 0.85
Stainless steel	24	0.28
White alumina ceramics	93	0.90
Hard rubber	23	0.94
Soft rubber	24	0.86

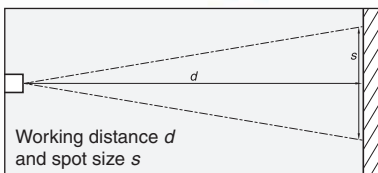

Spare batteries

Item No.	Type	Price EUR
495.157	CR2032	0.50
497.914	AAA	0.40

Item No.	908.800	909.413	909.412
Price	EUR 66.00	43.00	166.00
Measuring range	°C -55 to 250	-55 to 220	-60 to 760
Working distance d Optics ratio $d:s$	small 6:1	18 mm ($s=2.5$ mm)	large 30:1
Resolution	°C 0.1	0.2	0.1
Wave length	μm 5 - 14	5 - 14	8 - 14
Laser pointer	✓	✓ (dual)	✓
Emissivity	0.05 - 1 (incr. 0.01)	0.05 - 1 (incr. 0.01)	0.10 - 1 (incr. 0.01)
Emissivity preset	0.95	0.95	0.95
Illuminated LCD display	-	-	✓
Dimensions	mm 103 x 50 x 23	171 x 41 x 27	146 x 133 x 49
Weight (incl. batteries)	g 65	125	222
Power supply (batteries)	2x CR2032	2x AAA	2x AAA

Digital thermometer

- Measuring range: -40 to 200°C.
- Resolution: 0.1°C.
- Accuracy:
 - 0 to 100°C: ±1°C,
 - 100 to 200°C: ±2°C.
- Stainless steel measuring pin.
- °C/°F conversion.
- On/off switch.
- Power supply: 1 battery type V357.



Item No.	Measuring range/°C	Price EUR
909.421	-40 to 200	8.30
Option:		
836.535	Spare battery	1.90

Digital thermal imager

With this thermal imager one can easily measure and display (2.8" LCD color display) the thermal image and temperature.

- Measuring range: -20 to 250°C.
- Field of view: 40 x 40°.
- Accuracy: ±2°C or ±2%.
- Thermal sensitivity: 0.1°C.
- Thermal image resolution: 32 x 31 px.
- Emissivity preset: 0.95, selectable 0.10-1.00 per 0.01.
- USB data output.
- On/off switch.
- Automatic switch-off.
- Adjustable tolerance limits.
- Backlight with 3 selectable levels of brightness.
- °C/°F/°K conversion.
- 4 selectable color palettes.
- Alarm for adjustable upper and lower limit of the temperature.
- Frame rate: 9 Hz.
- Spectral range: 8 - 14 μm.
- Time stamp for images.
- Storage for 25000 images.
- Memory card: micro SDHC 8 GB, including adapter for SD card reader.
- Dimensions: 95 x 75 x 233 mm.
- Weight (incl. batteries): 390 g.
- Protection: IP54.
(When using data output: IP40.)
- Delivery in a case with USB cable and software.
- Power supply: 4 batteries type AA.



Item No.	Description	Price EUR
909.429	Thermal imager	494.00
Option:		
495.111	Spare battery (4 needed)	0.40

Digital thermohygrometer

- Measuring range: -10 to 50°C, 5-98%RH (with no condensation).
- Resolution: 0.1°C, 0.1%RH.
- Accuracy temperature: $\pm 1^\circ\text{C}$.
- Accuracy relative humidity at 25°C: $\leq 30\%RH: \pm 5\%RH$, $> 30\%RH: \pm 3\%RH$.
- °C/°F conversion.
- Measuring frequency: 2.5 times per second.
- Illuminated LCD display.
- On/off switch.
- Automatic switch-off.
- Hold and min/max functions.
- Dimensions: 151 x 83 x 26.5 mm.
- Weight: 251 g.
- Delivery in a case.
- Power supply: 1 battery type PP3 (9 V).



Item No.	Measuring range/°C	Measuring range/%RH	Price EUR
909.130	-10 to 50	5-98	101.00
Option:			
495.161	Spare battery		1.50



Digital thermohygraph for permanent monitoring

The new technology for permanent 24 hours registering and checking the temperature and humidity in the area and measuring rooms. Typical metrology room temperature is $20 \pm 0.05^\circ\text{C}$, with a resolution of 0.1°C for registering the temperature.

- Measuring range: -10 to 60°C, 0-100%RH (with no condensation).
- Resolution: 0.01°C , 0.1%RH.
- Accuracy temperature: $\pm (0.1 + |T-20|/250)^\circ\text{C}$ (T in °C).
- Accuracy relative humidity: 4%RH.
- °C/°F conversion.
- Min/max/P-P function.
- Stand-alone: memory for 500 000 measurements (interval: adjustable).
- Data-logger with Bluetooth, SD card and USB connection for data analysis (initial settings via PC).
- Including software for Windows (7 or later) and app for Android and IOS.
- Audiovisual alarms: temperature: 2 upper und 2 lower limits, humidity: 4 limits, temperature change: 2 limits.
- Graphs: on e-paper display or PC.
- Including wall support and desk stand.
- Dimensions: 75 x 110 x 30 mm.
- Delivery in a case.
- Power supply: 2 batteries type AA or USB (adapter not supplied).

Item No.	Description	Price EUR
837.800	Thermohygraph	1,328.00
Option:		
495.111	Spare battery (2 needed)	0.40



Digital tachometers – contact, laser, laser/contact

With these digital laser tachometers very accurate non-contact and/or contact measurements can be done easily.

- Measuring range contact: 0.5 - 19 999 rpm,
0.05 - 1999.9 m/min.
- Measuring range laser: 2.5 - 99 999 rpm.
- Resolution:
 - < 1000 rpm: 0.1 rpm,
 - ≥ 1000 rpm: 1 rpm,
 - < 100 m/min: 0.01 m/min,
 - ≥ 100 m/min: 0.1 m/min.
- Range: 5 - 50 cm (laser).
- Accuracy: $\pm(0.05\% + 1 \text{ digit})$.
- Laser/contact switchable (909.146).
- Automatic switch-off.
- Functions: max., min. and last measured value.
- Dimensions and weight:
 - 909.148: 174 x 72 x 38 mm, 240 g,
 - 909.152: 182 x 70 x 34 mm, 170 g,
 - 909.146: 198 x 70 x 34 mm, 225 g.
- Laser class 2 according IEC825-1 and EN60825-1.
- Power supply:
 - 909.148: 4 batteries type AA,
 - 909.152: 3 batteries type AAA,
 - 909.146: 4 batteries type AAA.



909.148



909.152



909.146



909.348

Item No.	Description	Price EUR
909.148	Digital contact tachometer	54.00
909.152	Digital laser tachometer	35.70
909.146	Digital laser/contact tachometer	69.00
Options:		
497.914	Spare battery type AAA	0.40
495.111	Spare battery type AA	0.40
906.811	Reflective tape per meter (width 25 mm, for laser tachometers)	7.30
909.348	Set contact points for tachometers 909.146/148	12.90

Tachometers

- Measuring range:
0 - 10000 rpm and 0 - 1000 m/min.
- Graduation: 0.002 x the measuring range.
- Includes attachments.

Item No.	Measuring range		Price EUR
	rpm	m/min	
855.850	0 - 10000	0 - 1000	178.00
855.852	0 - 10000	0 - 1000	337.00
	0 - 1000	0 - 100	
Options:			
855.853	Conical tip		5.30
855.855	Concave tip		5.30
855.856	Wheel		10.60



855.850

Torquemeters

- Measuring range: 0.04 - 500 Ncm.
- Intended for static measurements.
- Includes 6 attachments for
2 to 7 mm shafts for the small models, and
3 to 8 mm shafts for the large models.

Item No.	Measuring range/Ncm	Graduation Ncm	Price EUR
Small model:			
857.730	0.04 - 0.5	0.02	525.00
857.732	0.1 - 1.5	0.1	525.00
857.734	0.2 - 3	0.2	547.00
857.736	0.4 - 6	0.5	547.00
857.738	1 - 12	1	547.00
Large model:			
857.740	2 - 20	0.5	680.00
857.742	5 - 40	1	680.00
857.744	10 - 80	2.5	725.00
857.746	20 - 160	5	725.00
857.747	40 - 320	10	797.00
857.748	50 - 500	10	797.00



857.730



857.740

Digital torquemeters

Instrument for the testing and measuring of torque.

- Measuring range: 0 - 500 N·m.
- N·m/kgf·cm/lbf·inch conversion.
- RS232C data output.
- Automatic switch-off.
- Peak hold function.
- Go/NoGo tolerance evaluation.
- Memory for 10 values.
- Average value calculation.
- Weight: 2.4 kg (model I) or 22 kg (model II).
- With built-in printer (only model II).
- Delivery with an RS232C cable.
- Power supply: AC adapter 220 V, 300 mA (model I) or 220^{±10%} V, 100 W (model II).



PRICE



Item No.	Measuring range/N·m	Resolution N·m	Accuracy	Price EUR
With integrated sensor (model I):				
909.370	0 - 1	0.0005	±0.5%	982.00
909.371	0 - 5	0.002	±0.5%	982.00
909.372	0 - 10	0.005	±0.5%	982.00
With external sensor (model II):				
909.373	0 - 50	0.02	±1%	2,110.00
909.374	0 - 100	0.05	±1%	2,110.00
909.375	0 - 500	0.2	±1%	2,110.00
Option:				
900.825	Printing paper (5 rolls)			28.00

Strain gauges

Handy strain gauges suitable for measurements in two directions.

- Measuring range: 0.005 - 100 N.
- Indication accuracy:
± 2% of the entire scale.
- With peak pointer.



857.701



857.724

Small model

Item No.	Measuring range/cN	Graduation cN	Price EUR
857.701	0.5 - 5	0.1	236.00
857.702	1.5 - 15	0.5	193.00
857.703	3 - 30	1	193.00
857.704	5 - 50	1	193.00
857.705	10 - 100	2	193.00
857.706	15 - 150	5	214.00
857.707	25 - 250	5	214.00

Large model

Item No.	Measuring range/N	Graduation N	Length mm	Price EUR
857.721	0.25 - 2.5	0.05	153.5	333.00
857.722	1 - 5	0.1	153.5	333.00
857.723	1 - 10	0.5	153.5	333.00
857.724	2 - 20	1	153.5	489.00
857.725	3 - 30	0.5	153.5	489.00
857.726	4 - 40	1	153.5	489.00
857.727	5 - 50	1	127.5	531.00
857.728	10 - 100	2	127.5	576.00

Strain gauges

Handy measuring instruments suitable for measurements in two directions. Used to check the measuring force of dial indicators, lever type indicators, CMM probes etc. The flat touch surface has a $\varnothing 1$ mm bore.

- Measuring range: 0.006 - 5 N.
- Indication accuracy:
± 4% of the entire scale.



- With peak pointer.

Item No.	Measuring range/N	Graduation N	Price EUR
909.390	0.006 - 0.05	0.002	36.60
909.391	0.01 - 0.1	0.005	36.60
909.392	0.03 - 0.3	0.01	36.60
909.393	0.04 - 0.5	0.02	36.60
909.394	0.1 - 1	0.05	36.60
909.395	0.15 - 1.5	0.05	36.60
909.396	0.3 - 3	0.1	36.60
909.397	0.4 - 5	0.2	36.60

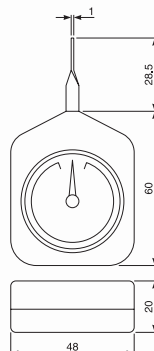

909.395

Digital spring scales

- Measuring range: 0- 25 kg.
- Resolution: 0.005, 0.01 or 0.02 kg.
- Kg/lbs conversion.
- Automatic switch-off.
- Reset at weight empty box possible.
- Automatic hold function.
- Memory for maximum weight.

- Dimensions and weight:
909.126: 100x 58x22 mm, approx. 100 g,
909.123/124: 149x 100x 35 mm, approx. 200 g.
- Power supply:
909.126: 3 batteries type AAA,
909.123/124: 1 battery type PP3 (9 V).

Item No.	Measuring range/kg	Resolution kg	Accuracy kg	Price EUR
909.126	0- 5	0.005	±0.02	35.90
909.123	0- 10	0.01	±0.01	42.00
909.124	0- 25	0.02	±0.02	44.00
Options:				
497.914	Spare battery type AAA			0.40
495.161	Spare battery type PP3			1.50



Dynamometers

Robust dynamometers in analog and digital model with several set-up pieces.

- Measuring range: 0- 500 N.
- Push and pull.
- Max/peak function.

Analog

- Accuracy: ± 1%.
- Graduation: N and kg.
- With 4 tapped holes M3 (for mounting).
- Dimensions: 225 x 60 x 51 mm.
- Weight: approx. 600 g.

Digital

- Accuracy: ±0.2%.
- Kg/lb/N conversion.
- On/off switch.
- Automatic switch-off.
- Reversible display value.
- With 4 tapped holes M4 (for mounting).
- Dimensions: 147 x 75 x 38 mm.
- Weight: approx. 400 g.
- Power supply: AC adapter (12 Vdc, 1 A) and rechargeable battery.



Item No.	Measuring range/N	Reading N	Price EUR
Analog:			
909.175	0- 10	0.05	146.00
909.178	0- 50	0.2	146.00
909.180	0- 200	1	146.00
909.182	0- 500	2	146.00
Digital:			
909.168	0- 5	0.001	492.00
909.169	0- 10	0.01	474.00
909.171	0- 50	0.01	325.00
909.173	0- 200	0.1	325.00
909.174	0- 500	0.1	325.00

Digital vibration tester

Instrument with external sensor for quick checking of unbalance, misalignment, bearings and gears. For measuring velocity, acceleration, displacement and frequency.

Measuring range

- Velocity: 0.01 - 40 cm/s (RMS, at frequency 10 Hz - 1 kHz).
- Acceleration: 0.1 - 400 m/s² (peak value, at frequency 10 Hz - 1 kHz or 10 Hz - 10 kHz).
- Displacement: 0.001 - 4.0 mm (P-P, at frequency 10 - 500 Hz).
- Frequency: 0.1 - 20 kHz.

Further specifications

- Accuracy: $\pm 5\% + 2$ digits.
- mm/inch conversion.
- RS232C data output.
- Operating temperature: 0 to 50°C.
- Dimensions: 125 x 62 x 31 mm.
- Weight: 255 g.
- Delivery in a case, incl. magnet and 2 attachments.
- Power supply: 4 batteries type AAA.



Item No.	Description	Price EUR
909.065	Vibration tester	414.00
Options:		
497.914	Spare battery (4 needed)	0.40
909.074	RS232C cable and software	82.00

Digital sound level meter

Instrument for measuring the sound level.

- Measuring range: 30 - 130 dB.
- Resolution: 0.1 dB.
- Accuracy: ± 1.5 dB.
- Frequency weighting: A and C.
- Frequency range: 31.5 Hz - 8.5 kHz.
- Measuring frequency: 2 times per second.
- Time weighting: fast/slow.
- The current measured value within the range of 50 dB is graphically displayed (adjustable).
- Over range indication.
- Automatic switch-off.
- Max function.
- Dimensions: 207 x 70 x 29 mm.
- Weight: 178 g.
- Delivery in a case.
- Power supply: 1 battery type PP3 (9 V).



Item No.	Measuring range/dB	Price EUR
909.131	30 - 130	117.00
Option:		
495.161	Spare battery	1.50

Refractometers

Refractometers for regular checking the correct mixing ratio of coolants. A correct proportion is very important.

- Measuring range: 0-32% Brix.
- Graduation: 0.1 or 0.2% Brix.
- Accuracy: $\pm 0.2\%$.
- Adjustable eyepiece.
- Adjustment screw for zero setting (protected by rubber cap).
- Rubber eye adapter.
- Ergonomic design.
- Weight: 200 g.
- Delivery in a case incl. cleaning cloth, screwdriver, bottle with distilled water (for calibration), pipette.



909.079



Item No.	Meas. range % Brix	Graduation % Brix	Price EUR
909.090	0-10	0.1	69.00
909.079	0-32	0.2	75.00



Telescopic mirror/magnet

- Adhesive force magnet: 5 N.
- Max. length (extended length): 480 mm.



909.343

909.344



Item No.	Description	Price EUR
909.343	Telescopic mirror	6.40
909.344	Telescopic magnet lifter	6.50

Sonarscope

For tracing mechanical problems by means of sound.



Item No.	Description	Price EUR
909.418	Sonarscope	13.50

Measuring instrument displays and interfaces



Remote Instrument Display

The Remote Instrument Display (RID) is an easy to use 2-channel display unit for connecting both RS232C and Mitutoyo instruments and display the measurement value on a large, well readable display. For a quick Go/NoGo indication both channels have their own 24 position LED bar with a user-defined upper and lower tolerance limit. Using the RID can simplify batch measurements significantly and makes human interpretation errors almost impossible. Also a combination of the RID with one or two scale units can be a low-cost solution for a digital read-out system on e.g. a drill press or lathe.

The RID is equipped with a Mitutoyo Digimatic and a RS232C output, so the measured values can be sent directly to a printer or PC by pressing the print button on the RID, the optional foot switch or by sending commands from the PC. Its lightweight construction, compact design and the simplicity of the controls make this RID a user-friendly and flexible accessory for your measuring instruments, suitable for use in both cleanroom and workshop.

- 2 display channels.
- 2 LED bars with 22 positions each.
- LED bar indication option: bar or individual LED.
- User defined upper and lower tolerance limit for Go/NoGo indication.
- 2 RS232C inputs.
- 2 Mitutoyo Digimatic inputs.
- RS232C data output for PC or printer.
- Mitutoyo Digimatic printer output.
- Foot switch input.
- Keyboard data output option (see Smartbox).
- Power supply: mini AC adapter (6 Vdc).



Item No.	Description	Price EUR
348.043	Remote Instrument Display	325.00
Options:		
348.286	RS232C cable 1.8 m	8.10
348.287	RS232C cable 3 m	18.30
348.288	RS232C cable 5 m	26.40
348.186	Foot switch metal Economic	43.00
348.190	Foot switch metal Herga	70.00
348.189	Foot switch metal Industrial	108.00
495.147	PS/2 keyboard cable 1.8 m	4.10

Smartbox

The Smartbox is an interface that connects various digital (measuring) instruments and indicators to computer programs, such as Approve, spreadsheets and databases. This will make a program-oriented software driver redundant.

The measuring value of the connected instrument is read into standard software as spreadsheet or Approve as if it has been entered by means of the keyboard. The USB Smartbox is linked directly to a USB port (cable is included).

It is possible to connect an instrument equipped with a Mitutoyo or RS232C data output with the Smartbox, for example TESA, Magnescale, Kröplin, Preisser, Helios. However, instruments need a specific data cable. See also table below.

The Smartbox is equipped with a 10p Mitutoyo compatible and an RS232C 9p (male) D-connector, and also has a program-controlled microprocessor. The DIP switches allow you to choose between the various instruments. The Smartbox is powered by your PC.

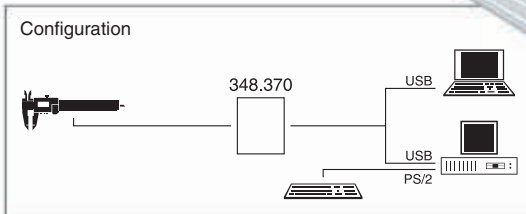

Item No.	Description	Price EUR
348.370	USB Smartbox for 1 instrument	135.00
Options:		
348.186	Metal foot switch Economic	43.00
348.190	Metal foot switch Herga (0.25 kg)	70.00
348.189	Metal foot switch Industrial (1 kg)	108.00
Besides all Mitutoyo Digimatic cables, the following cables are suitable for the Smartbox:		
348.109	Cable Kröplin, equipped with a 10p Mitutoyo plug (2 m)	68.00
348.122	Cable Magnescale U-serie and LT-serie / RS232C 9p (2 m)	46.00
348.142	RS232C-cable Sartorius 9p (3 m)	49.00
781.887	Opto-RS232C-cable 9p sub-D for TESA, Sylvac, Preisser etc. (2 m)	120.00
348.153	RS232C-cable Mettler 9p (female) (3 m)	48.00
348.154	Cable for Heidenhain RS232C 9p (3 m)	49.00
348.155	Cable for TESA-TT10 (2 m)	49.00
348.239	Cable LH20/LY10 RS232C 9p (female) (3 m)	53.00

D/RS Instrumentbox

With the D/RS Instrumentbox RS232C and Mitutoyo Digimatic instruments can be read into a PC, making them online available for Approve or other software. The box is equipped with four 10p Digimatic and four 9p sub-D connectors, allowing the maximum of four RS232C or eight instruments with a Digimatic output to be connected. There is also a foot switch connection. The box can be connected to a PC's COM (RS232C) or, via an optional adapter, USB port.



348.041



495.208

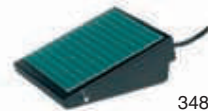

348.186

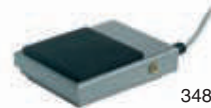

348.190



348.189

Item No.	Type/description	Price EUR
348.041	D/RS Instrumentbox incl. AC adapter and cable 9p (3 m) (for RS232C cables: see Smartbox)	505.00
Options:		
495.208	RS232C-USB adapter	27.90
348.163	Adapter cable Digimatic - 9p sub-D	24.50
348.186	D/RS foot switch Economic	43.00
348.190	D/RS foot switch Herga	70.00
348.189	D/RS foot switch Industrial	108.00

Mitutoyo data processing

Mitutoyo has several options for the collection of measuring data such as printing and statistical analysis using the Digimatic SPC printer, direct data collection via a USB cable or interface modules and wireless via the U-WAVE Wireless Communication System.

Mitutoyo Digimatic SPC printer

The thermal SPC printer DP-1VR for fast and easy printing of the measuring values of calipers, micrometers and other measuring instruments. Suitable for statistics, calculations and reports. For measuring instruments with an RS232C output a special RS232C→Mitutoyo interface has been developed.

- Prints the measured values with statistical calculations of N, -NG, +NG, P, MAX, MIN, R, \bar{x} , σ_n , σ_{n-1} , Cp, Cpk, Histogram, Xd control charts, control limits, date and time in a clear and surveyable way.
- Timer for automatic input intervals.
- Capacity of 9999 measurement data.
- Delivery with AC adapter, batteries and a roll of printing paper.
- Power supply: AC adapter (6 Vdc) or 4 batteries type AA.



264.504



937.179

Item No.	Type/description	Price EUR
264.504 ¹	DP-1VR SPC printer	463.00
Options:		
495.111	Spare battery (4 needed)	0.40
348.042	RS232C→Mitutoyo interface	53.00
937.179	Foot switch	44.00
900.825	Printing paper (5 rolls)	28.00

¹ Incl. AC adapter (6 Vdc) and a roll of printing paper.

Digimatic USB interface

USB interface for reading measuring values from a Digimatic measuring instrument into PC applications. Send the measuring values with the data switch or the optional foot switch.

Please contact us for instrument specific cables and system requirements.



264.016

NEW

Item No.	Description	Price EUR
264.016	Digimatic USB interface	213.00
937.179	Foot switch	44.00

USB Input Tool Direct

Direct connection of the measuring instrument to a USB port. Multi channel input of measurements into for example Microsoft Excel is also possible. The USB-ITPAK software provides easy manipulation of Excel sheets.

Please contact us for instrument specific cables and system requirements.

Item No.	Description	Price EUR
937.179	Foot switch	44.00
206.384	USB foot switch adapter	104.00
206.846	USB-ITPAK software	228.00

U-WAVE Wireless Communication System

Wireless system for the transmission of Digimatic instrument measuring data to a PC for data analysis in for instance Microsoft Excel. The systems consists of a transmitter and receiver with a communication distance up to 20 meter within visible range. Up to 100 transmitters can be connected to a receiver and up to 16 receivers to a PC. Measuring data can be sent from the measuring instrument or requested by the PC.

Please contact us for instrument specific cables and system requirements.

Item No.	Description	Price EUR
102.880	U-WAVE Sender standard	163.00
102.730	U-WAVE Sender IP67	163.00
102.810	U-WAVE Receiver and software	324.00
Option:		
937.179	Foot switch	44.00



Interfaces

For the simultaneous connection of several measuring instruments to a PC interface units are available. Timed interval data transmission can be established with the Timerbox.

Please contact us for instrument specific cables and system requirements.



Item No.	Description	Price EUR
630.107	Timerbox	367.00

TESA data processing

TESA has several options for the collection and analysis of measuring data from suitable measuring instruments and probes. Options include direct data collection via a USB cable or interface modules and wireless via the TWIN station Wireless Communication System.

TESA Link Connector

Suitable measuring instruments can be connected directly to a PC with DATA-Direct using the TESA Link Connector-USB or to a Digimatic interface. The TESA Link Connector-USB is delivered including a demo version with limited functionality of the Data-Direct software.

Item No.	Type/description	Price EUR
783.301	TLC-USB cable	118.00
783.302	TLC-Digimatic cable	170.00
Options:		
783.037	DATA-Direct software for data acquisition	390.00
783.038	STAT-Express for statistical analysis	920.00

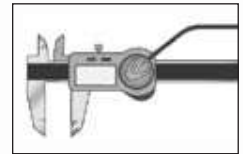

TESA TWIN Station / BPX44 interface

- USB data output.
- Dimensions: 55 x 172 x 155 mm.
- TESA Interface Software TIS included.

TESA TWIN Station

Wireless system for the transmission of measuring data from TWIN-Cap measuring instruments to a PC. The TWIN Station can also be used with the TESA wireless probes. The system consists of a transmitter and a receiver.

- Connect up to 8 instruments to an interface.
- Connect up to 8 interfaces (64 instruments maximum).

TESA BPX44 interface

For the connection and management of TESA probes using a PC. The BPX44 can besides direct connection to a PC also be used autonomously using the digital output connection. The BPX44 Probe interface is compatible with the TWIN Station.

- Connect up to 4 probes to an interface.
- Connect up to 16 interfaces (64 instruments maximum).



783.314

Item No.	Type/description	Price EUR
783.314	TESA TWIN Station	402.00
783.317	TESA BPX44	980.00
Options:		
783.313	Fixation supports	42.00
783.315	7 port USB Hub	172.00



783.317

**DeMeet 3D CNC coordinate measuring machines
DF fixture system / Alufix fixture system**

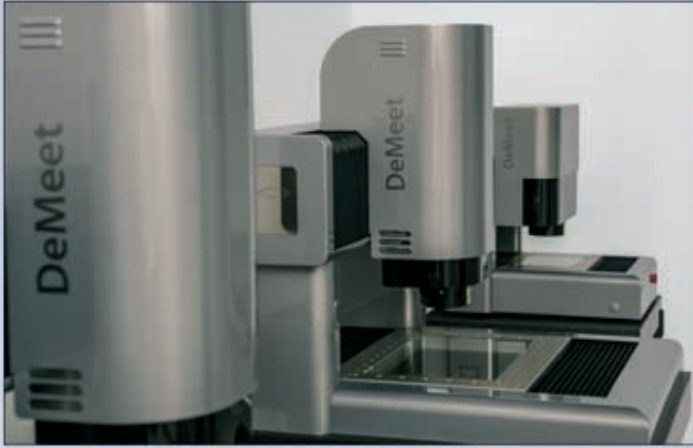

Download the
brochure from
Schut.com

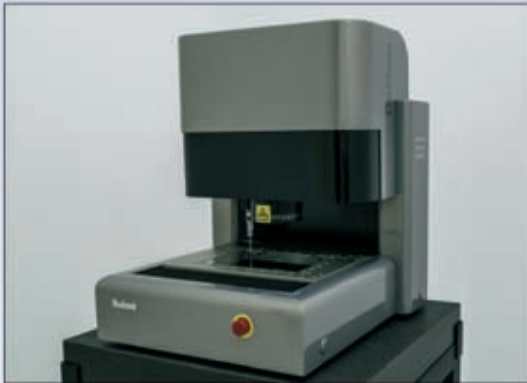

*DeMeet-220 Video model
complete from:
EUR 20,000.00
(excl. PC system)*



NEW

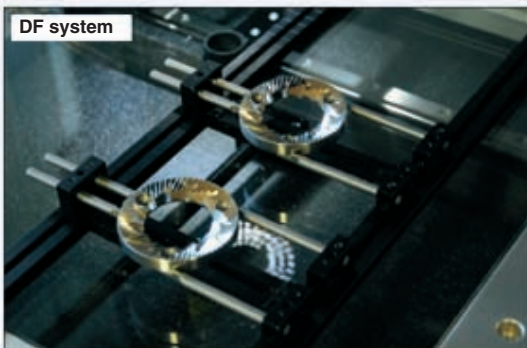

DF system

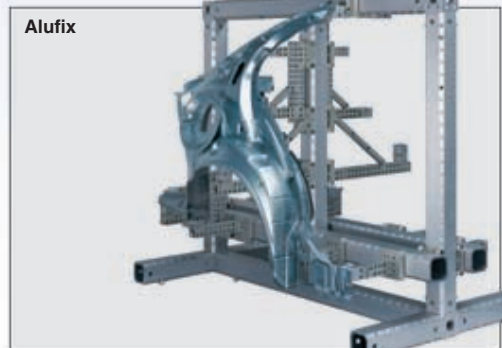

Alufix

C23.001.EN.20170420

DeMeet video and multi-sensor measuring machines



DeMeet coordinate measuring machines

The DeMeet 3D CNC coordinate measuring machines provide automatic, user-independent quality control with measuring results traceable to the international length standard. The DeMeet measuring machines are available in Video (optical) and Combo model (multi-sensor for combined video and touch probe measurements). The DeMeet multi-sensor measuring machines are an excellent all-in-one alternative to other measuring devices for example a measuring microscope, profile projector and height gauge.

With an excellent price-performance ratio the DeMeet measuring machines enable high precision quality control in measuring laboratories as well as on the production floor. Applications of optical and multi-sensor measuring are among others in the precision engineering, medical, plastics and electronics industry.

Design and quality

The application of quality components made by Schut and by well-known, specialized manufacturers ensures excellent performance and high accurate measurements.

With the new design of the DeMeet measuring machine series no concessions have been made to accuracy and reliability. The new visually screwless cover design provides a better protection in the production environment and is highlighted with nickel-plated aluminum details which can be personalized. The open design of the DeMeet allows for easy operation and loading of the machine from all sides.

The accuracy of the DeMeet measuring machines is guaranteed by a CAA 3D correction model (Computer-Aided Accuracy, error compensation).

Machine construction

The construction is a granite base plate with accuracy grade according to DIN 876/00, placed on well positioned shock absorbing points and resting on a welded base frame (for the DeMeet-220 the base plate is flat grinded cast iron).

The XYZ base structure for the THK precision preloaded caged ball linear guides is made from extremely tension relieved, flat grinded cast iron, as the basis for a mechanical accurate construction. The axis drive system consists of Faulhaber high torque DC servo motors, TFE coated Kerk lead screws and Renishaw TONIC optical linear encoders with low sub-divisional error.

The measuring table is made of tension relieved, wear-resistant, hard anodized aluminum, or optionally nickel-plated steel, with a mounting hole pattern for product fixtures and a flat aligned glass plate. The video model consists of a DeMeet camera with a Sony sensor and a telecentric optical system. In addition to the optical system the Combo model is equipped with a Renishaw touch probe system.



NEW

Download the
brochure from
Schut.com



DeMeet video measuring machines

Optical measurements

Optical measurements are performed using the camera system, optics and adjustable illumination. Due to the non-contact nature of the measurements there is no risk of product deformation. Optical measuring is very suitable for products with fine structures and contact sensitive products.

Another advantage of optical measurements is that edge information can be defined directly with high density of measuring points. Within the field of view of the DeMeet a very high accuracy can be achieved.



Optical system

A combination of high quality telecentric optics and DeMeet Sony sensor camera is integrated for a clear image with an excellent contrast and a high resolution. In combination with the image processing functionality of the DeMeet, this results in highly accurate measurements.

Telecentric optics are supplied as a standard to avoid perspective image distortion around the center of the field of view. The DeMeet is either equipped with Nikon or Leica-Design optics with a large working distance for a brilliant image with high contrast providing optimal edge detection.



NEW

Lenses with various magnifications from 1x to 10x are available and can be exchanged during a measuring run, generating a range in display magnification from 40x to 400x.

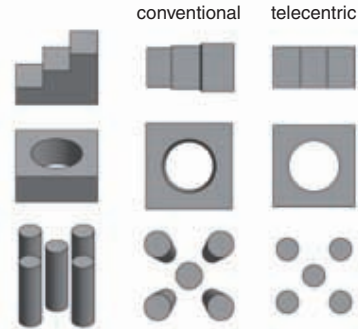

Illumination

Illumination is essential for accurate measurements. The DeMeet is standard equipped with LED based illumination (backlight, coaxial light and segmented ring light). A ring light consisting of a 3 rings, 16 segments and 48 cells LED pattern, that can be controlled per individual ring, segment and cell, is standard supplied for optimal light configuration.

The ring light can be set in intensity and angle to achieve the best contrast with clearly defined edges. The backlight is transmitted from below and is used to highlight the profile of the edges. Coaxial lighting can be used for illumination inside deep located structures. The LED based backlight and coaxial light can be adjusted in intensity.

The configuration of the illumination is automatically controlled during a CNC measuring run. A coaxial laser pointer assists navigation during creation of a measuring program.

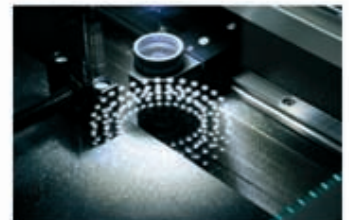

DeMeet multi-sensor measuring machines



Multi-sensor measurements

The increasing miniaturization and complexity of product features results in more difficult measuring and inspection procedures. Measuring systems equipped for only optical or contact measurements are often no longer sufficient, in which case multi-sensor measuring machines are required for optimal geometrical quality control.

When measuring certain features encounters the physical limits of non-contact measurement, the DeMeet video machines can be additionally equipped with a touch probe system (contact measuring system).

With the DeMeet Combo model both optical and contact measuring principles are seamlessly integrated and measurements can be performed by the optical and the probing system within one measuring run and even within one feature. Touch probe measurements can also be useful to create a complex 3D product alignment.

Probe modules and styli

Standard a Renishaw TP20 system with a 5-way stylus configuration is supplied. On request various probe modules, systems and stylus configurations are available. Multiple probe modules can be used to leave the stylus configuration on the module to achieve a shorter set-up time for measurements requiring other stylus configurations.

In addition to the standard touch probe system, an optional stylus change rack (automatic probe configuration change) can be utilized. With the stylus change rack probe modules can automatically be exchanged within one measuring run.

NEW

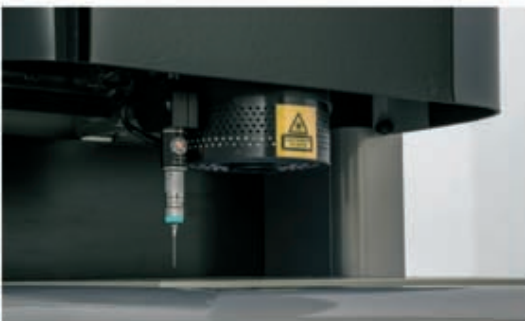

DeMeet video and multi-sensor measuring machines (continued)

Approve for DeMeet multi-sensor measuring software

Approve for DeMeet is a true multi-sensor software package, where the difference in sensor origin of the measuring input is limited to only the necessary. All the measuring results of video and touch probe can be displayed, reported, exported and used in constructs together, and are dynamically updated. The measuring results can also be displayed together in a 3D view. *Approve for DeMeet* is designed to be a user-friendly software package, but is flexible and very elaborate to measure many products.



3D Movements

The 3D motor controller in *Approve for DeMeet* makes blended, smooth moves which makes the DeMeet run more fluent and faster. The DeMeet also moves during video image processing and other calculations, shortening the measuring time considerably. To eliminate hysteresis, and therefore improving accuracy, an approach direction and distance can be set for video measurements. Pretouch and average touch can be set for touch measurements.

Measurements

For video measurements our proprietary image processing algorithms were developed, which are completely different from algorithms used by competing products. The edge find algorithm finds complete curves instead of separate points, the interpolation of the pixels is virtually infinite and very accurate. Video targets larger than one field of view can be measured in one program step, and are automatically split into more images and combined for the fitted result. The illumination for video measurements can be set and changed using a graphical control for backlight, coaxial light and ring light.

For touch measurements it is normal that the targets are defined in 3D, but now this is also the case for video measurements. Features (like a circle) can be measured properly even if they are not parallel to the camera (optical) plane. The graphical touch probe configuration editor allows for building a custom configuration for a specific measurement by using an extensive touch probe library. Settings can be defined and shared between measuring steps which greatly reduces the complexity of a measuring program.

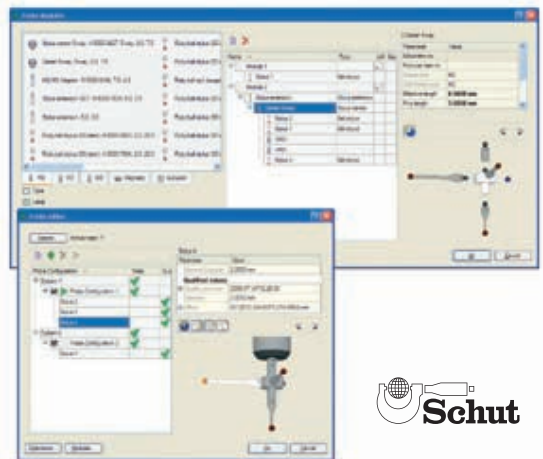

NEW

APPROVE
for DeMeet

Download the
brochure from
Schut.com

 **Schut**

DeMeet video and multi-sensor measuring machines (continued)

Measuring Program

A measuring program in *Approve for DeMeet* is a graphical program consisting of simple program steps. Program steps can be changed, added, copied, moved and removed very easily, inputs of a program step can be easily changed or linked to other results by using drag-and-drop. A program can be verified by running it step by step, even a single program step can be run for verification. After running a program step an icon appears behind it to indicate its status.

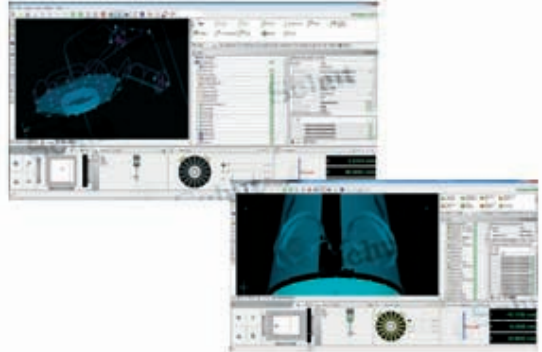

APPROVE
for DeMeet

Download the
brochure from
Schut.com

NEW

Results, Report and Export

Results from measurements and calculations (constructs, fits, etc.) as well as from other program steps can be added to an export or report and saved or printed as PDF or CSV file for further analysis. If tolerances are used for a result a graphical tolerance bar is shown. Results and reports can be automatically printed or exported at the end of a measuring program run.

PTB software evaluation

Evaluation software for coordinate measuring machines. The accuracy of the *Approve for DeMeet* software was verified by comparing the results obtained from the software with reference results supplied by the PTB (Physikalisch-Technische Bundesanstalt, Braunschweig, Germany). The *Approve for DeMeet* software has been placed in the class of the smallest deviations.

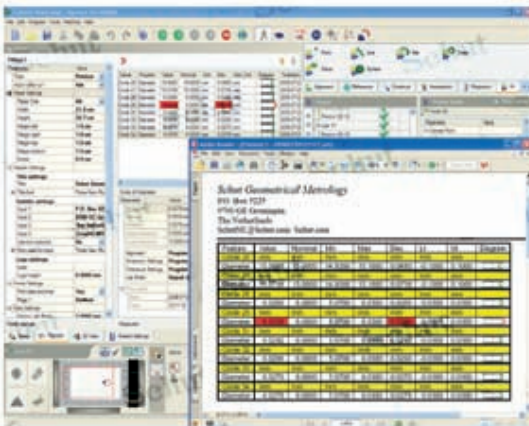

Specifications DeMeet video and multi-sensor measuring machines

	Video model	Combo model
General		
Video system	DeMeet Sony sensor camera	
Leica-Design telecentric lenses	2.0x (1.0x, 5.0x and 10.0x optional)	
Nikon telecentric lenses	3.0x (1.0x, 5.0x and 10.0x optional)	
Ring light ¹	3 rings, 16 segments and 48 cells (adjustable)	
Backlight and coaxial light	adjustable	
Probe system ²	-	Renishaw TP20
Construction ³	fixed bridge with granite base plate DIN 876/00	
Structure	extremely tension relieved, flat grinded cast iron	
Measuring table ⁴	tension relieved, hard anodized aluminum	
Linear guides	THK linear guides	
Linear encoders	Renishaw TONIC linear encoders	
Drive system	Faulhaber DC servo motors	
Operating mode	motorized joystick / CNC	
Measuring specifications		
Resolution (µm)	0.5 (0.1 optional)	
Accuracy standard ⁵ (µm)	X/Y/Z 4 + L/150	
(0.5 µm resolution) (L in mm)	XY 5 + L/150	XYZ 5 + L/150
Accuracy optional ⁵ (µm)	X/Y/Z 3 + L/200	
(0.1 µm resolution) (L in mm)	XY 4 + L/200	XYZ 4 + L/200
Travel speed max. (mm/s)	X/Y 250, Z 55	
Acceleration max. (mm/s ²)	X/Y/Z 500	
Power requirements		
Voltage (V)	90 - 120, 210 - 240 (50 - 60 Hz)	
Power (VA)	400	
Environmental conditions		
Operating temperature (°C)	15 - 35	
Measuring temperature (°C)	20 ± 0.5	
Humidity (%)	40 - 70 (no condensation)	

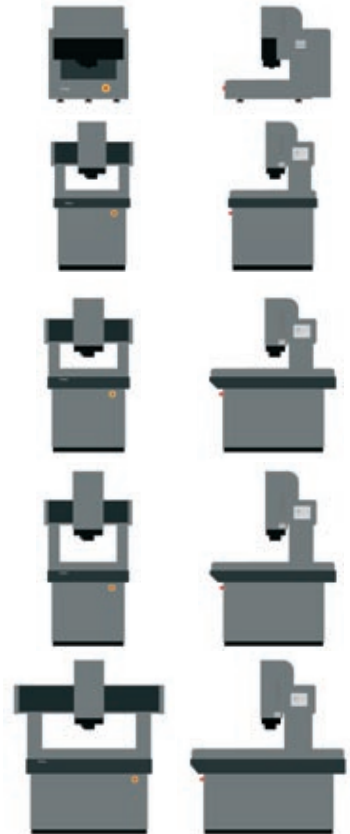

¹For video models (except DeMeet-220) a ring light with 4 rings, 16 segments and 64 cells can be supplied as an option.

²Other probe systems can be supplied as an option.

³The base plate of the DeMeet-220 is made of flat grinded cast iron.

⁴Optional available in tension relieved nickel-plated steel.

⁵The accuracy of the multi-sensor measuring system should be taken into account.

Specifications apply to all DeMeet models, unless otherwise specified. Machines with higher specifications and/or modifications are available on request.

Specifications are subject to change without prior notice.

For more specifications refer to our website Schut.com.



CE The DeMeet measuring machines are in compliance with EC Machine Directive 2006/42/EC, Electromagnetic Compatibility (EMC) directive 2014/30/EU and Low Voltage Directive (LVD) 2014/35/EU.

DeMeet-220		
Measuring range (mm)	X 220, Y 150, Z 100	
Dimensions (mm)	W 520, L 700, H 615	
Weight (kg)	110	
Measuring table (mm)	X 357, Y 260	
Max. load (kg)	20	
DeMeet-400		
Measuring range (mm)	X 400, Y 250, Z 200	
Dimensions (mm)	W 865, L 930, H 1570	
Weight (kg)	530	
Measuring table (mm)	X 560, Y 422	
Max. load (kg)	50	

DeMeet-404		
Measuring range (mm)	X 400, Y 400, Z 200	
Dimensions (mm)	W 865, L 1245, H 1580	
Weight (kg)	700	
Measuring table (mm)	X 560, Y 580	
Max. load (kg)	50	

DeMeet-443		
Measuring range (mm)	X 400, Y 400, Z 300	
Dimensions (mm)	W 865, L 1245, H 1785	
Weight (kg)	720	
Measuring table (mm)	X 560, Y 580	
Max. load (kg)	50	

DeMeet-705		
Measuring range (mm)	X 700, Y 500, Z 300	
Dimensions (mm)	W 1520, L 1550, H 1820	
Weight (kg)	1400	
Measuring table (mm)	X 930, Y 700	
Max. load (kg)	60	

DeMeet-A7 touch probe measuring machines

The DeMeet-A7 measuring machine is designed with air bearing guides and a moveable bridge construction.

The application of quality components ensures excellent performance and highly accurate measurements.

With an excellent price-performance ratio the DeMeet measuring machines break the barrier for high-precision quality control on the production floor as well as in measuring laboratories.

NEW



Ask for
the detailed
brochure

General

Touch probe system	Renishaw
Work table	mounting hole pattern 33 inserts M8
Drive equipment	DC servo motors / air bearing guides
Operation	motorized joystick control / full CNC control
Construction	surface plate, portal and Z-axis: granite (DIN 876/00)

Measuring range

DeMeet-A7	(mm)	X = 500, Y = 715, Z = 400
-----------	------	---------------------------

Measuring specifications

Resolution	(μm)	0.5 (0.1 optional)
Accuracy 0.5 μm model	(μm)	U3 (XYZ) = $2.7 + L/300^*$
	(L in mm)	
Accuracy 0.1 μm model	(μm)	U3 (XYZ) = $1.9 + L/400^*$
	(L in mm)	
Max. velocity DeMeet	(mm/s)	X, Y = 400, Z = 300

*The accuracy of the probing system should be taken into account.

Specifications apply to all DeMeet models, unless otherwise specified.

Machines with higher specifications and/or modifications are available on request.

Specifications are subject to change without prior notice.

For more specifications refer to our website Schut.com.



Field of view qualifier

- Accuracy: ± 0.002 mm.



Item No.	Description	Price EUR
635.222	Field of view qualifier	99.00

Worktable DeMeet-220

The DeMeet-220 must be placed on a stable worktable for accurate measurements. Placing can be done on a strong work table or on a granite worktable like below.



Item No.	Description	Price EUR
402.004	Granite surface plate 630 x 630 x 80 mm, DIN 876/1	454.00
131.032	Support DeMeet-220 (working height 750 - 800 mm)	382.00

Qualification spheres

- Ball: $\varnothing 8$ or $\varnothing 25$ mm, made of ceramics.
- Delivery with a measuring report.

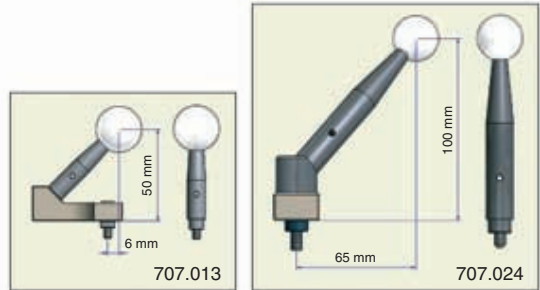

Item No.	Description	Price EUR
Qualification sphere $\varnothing 8$ mm:		
707.025	For DeMeet-220	468.00
707.026	For DeMeet-4xx/705	446.00
Qualification sphere $\varnothing 25$ mm:		
707.013	For DeMeet-220	360.00
707.024	For DeMeet-4xx/705	380.00

Training object

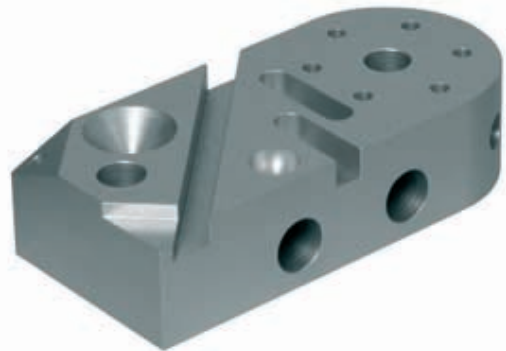

Item No.	Description	Price EUR
635.200	Touch probe training object	218.00

Fixture systems

Solid positioning of a measuring object with a fixture system is essential for accurate measurements and the fixing pattern can also be used for batch measurements. The measuring table of the DeMeet is prepared for DF and Alufix fixture systems.

DF product fixture system

DF-System is a fixture system developed and produced by Schut and designed for constructing 3D product fixtures, particularly for optical measurements, and is fully compatible with the measuring table of the DeMeet measuring machines. The DF-system is an easy to mount measurement fixture system and especially developed to use the most of the illumination possibilities for optical measurements. Easy to mount with single-screw couplings to build fixtures with a high repeatability and to realize a short set-up time for measuring tasks.

DF-System consists of a full range of fixture components: bars, connection components and fixing components. Produced from extruded or machined aluminum with either a black or silver anodized finishing. Technically the difference is only applicable for optical measurements in relation to (un)desirable light reflection.

DF is a universal fixture system and can be mounted on any type of measuring machine. With special couplings the system is fully compatible with the measuring tables of the DeMeet video and multi-sensor coordinate measuring machines.

Item No.	Description	Price EUR
717.057	Basic set I DeMeet-220 Black	990.00
717.088	Basic set I DeMeet-220 Silver	990.00
717.095	Basic set II DeMeet-400Y Black	1,040.00
717.096	Basic set II DeMeet-400Y Silver	1,040.00
717.058	Basic set III DeMeet-400X/4xxXY Black	1,095.00
717.089	Basic set III DeMeet-400X/4xxXY Silver	1,095.00

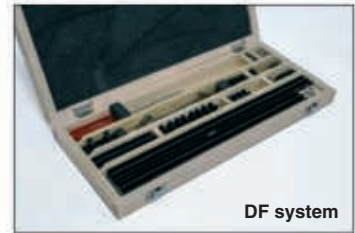

Alufix fixture system

Alufix is a flexible fixture system made of high-tensile aluminum. Alufix is a uniquely designed modular fixture system to prepare a product-fixture in a short time and is easy to mount and specially suitable for fixtures for heavier measuring objects. A wide range of components is available that can be combined to complete your measuring fixture such as base plates, bars, chucks, rotary plates, centers, magnetic holders, v-blocks, vises and optical targets.

Besides all the separate components two basic sets are composed for the DeMeet: an Alufix 16 set for light weight products and an Alufix 25 set for larger and heavier products.



Item No.	Description	Price EUR
381.100	Basic set Alufix 16 DeMeet for DeMeet-220 and DeMeet-400 (Y-axis)	2,360.00
381.101	Basic set Alufix 25 DeMeet for DeMeet-400 (X-axis), DeMeet-404 and DeMeet-443	2,570.00
381.099	Basic set Alufix 25 DeMeet-705 for DeMeet-705	3,160.00



Custom fixture systems for the DeMeet measuring machines

When products need to be measured in a batch and a standard fixture system does not provide the right solution for example caused by the extraordinary shape or small dimensions of the product, a custom made fixture can provide the solution. This is especially the case for products that need to be measured optically.

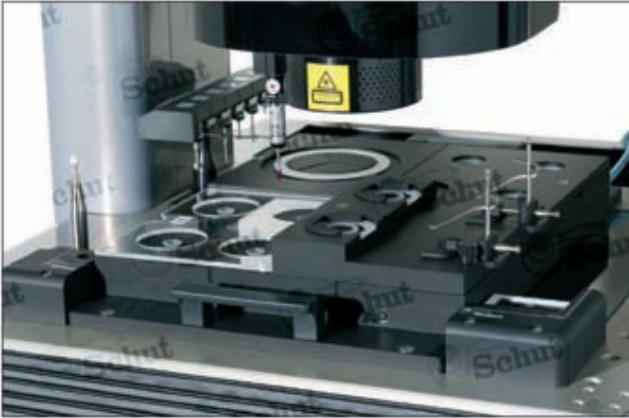

NEW



A certain repeatability of product positioning in the fixture is important for a quick set-up time in for example the production environment. We can assist in the development and manufacturing of a custom fixture. There is a range of possibilities, from machined fixturing positions in acryl glass to magnet and vacuum fixture systems.



DF product fixture system

DF is a new fixture system developed and produced by Schut and designed for building 3D product fixtures, particularly for optical measurements.

Solid product positioning is essential for accurate measurements. DF is very easy to mount with single-screw couplings to build fixtures with a high repeatability and to realize a short lead-time for measuring jobs.

DF consists of a full range of fixture components: bars, connection components and fixing components. Produced from extruded or machined AlMgSi1 aluminum with either a black or silver anodized finishing. The black anodized version avoids light reflections. The silver components can be applied when light reflections from the fixture are required.

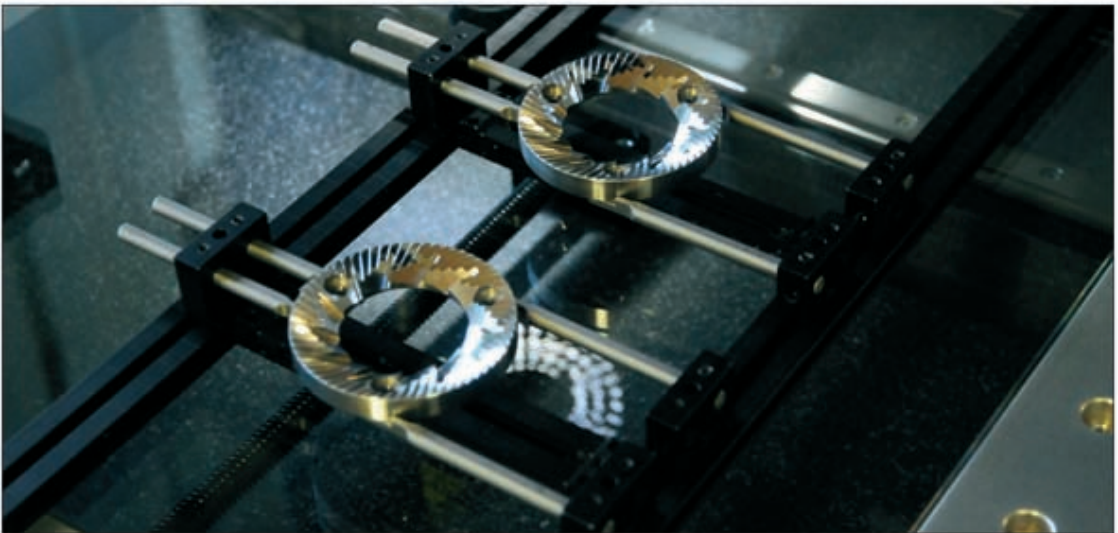

DF is a universal fixture system and can be mounted on any type of measuring machine. With special couplings the system is fully compatible with the measuring tables of the DeMeet video and multi-sensor coordinate measuring machines.

DeMeet

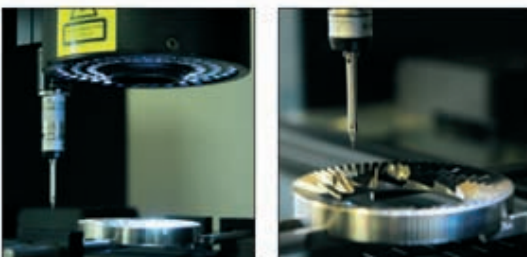

Download the
brochure from
Schut.com



DF product fixture system (continued)

DF is available in separate components and in three basic sets, in black or silver finishing. Basic set I is composed for the DeMeet-220, basic set II for the DeMeet-400 (Y-axis) and basic set III for the DeMeet-400 (X-axis) and the DeMeet-404/443 (X- and Y-axis).

Item No.	Description	Price EUR
717.057	Basic set I DeMeet-220 Black	990.00
717.088	Basic set I DeMeet-220 Silver	990.00
717.095	Basic set II DeMeet-400Y Black	1,040.00
717.096	Basic set II DeMeet-400Y Silver	1,040.00
717.058	Basic set III DeMeet-400X/4xxXY Black	1,095.00
717.089	Basic set III DeMeet-400X/4xxXY Silver	1,095.00

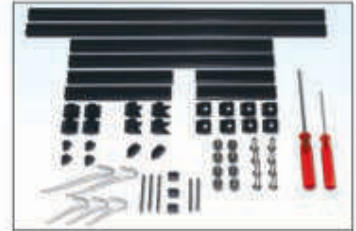

Item No.		Description	Number	Basic set		
black	silver			I	II	III
717.029	717.073	Mounting block perpendicular	8	•	•	•
717.030	717.074	One point anvil	4	•	•	•
717.031	717.075	One point anvil long	2	•	•	•
717.036	717.077	Mounting block for spring shaft	3	•	•	•
717.040	717.081	V-block 120°	2	•	•	•
717.042	717.083	V-block 90°	2	•	•	•
717.033	717.043	Mounting block side pattern 16	4	•	•	
717.028	717.072	Mounting block end pattern 16	4	•	•	
717.034	717.050	Mounting block side pattern 25	4			•
717.035	717.056	Mounting block end pattern 25	4			•
717.015	717.059	Bar 56 mm	2	•		
717.016	717.060	Bar 88 mm	2		•	
717.097	717.098	Bar 110 mm	2			•
717.017	717.061	Bar 120 mm	2	•		
717.018	717.062	Bar 160 mm	2			•
717.022	717.066	Bar 246 mm	2	•		
717.024	717.068	Bar 310 mm	2		•	•
717.026	717.070	Bar 344 mm	2		•	
717.025	717.069	Bar 460 mm	2			•
717.044		Screw and adapter pattern 16	4	•	•	
380.301		Distance tube with stop pattern 16	8	•	•	
380.304		Distance tube with stop pattern 25	8			•
993.539		Screw M4 x 20 stainless steel	8	•	•	
995.087		Screw M6 x 25 stainless steel	8			•
717.000		Shaft 60 mm for clamping spring	3	•	•	•
717.004		Shaft 50 mm for clamping spring	2	•	•	•
717.010		Clamping spring short	3	•	•	•
717.011		Clamping spring long	2	•	•	•
991.158		Hex screwdriver 2 mm	1	•	•	•
991.160		Hex screwdriver 3 mm	1	•	•	
991.161		Hex screwdriver 4 mm	1			•
717.008		Screw mounting tool	1	•	•	
851.888		Case for DF basic sets I and II	1	•	•	
851.899		Case for DF basic set III	1			•



Item No.	Description	Price EUR
991.158	Hex screwdriver 2 mm	5.30
991.160	Hex screwdriver 3 mm	7.60
991.161	Hex screwdriver 4 mm	8.10
991.276	Adjustable torque hex screwdriver 2 mm with range 0.1 - 0.6 Nm	81.00



991.276

DF components

Besides the components shown below, there are various other types available.

Bars

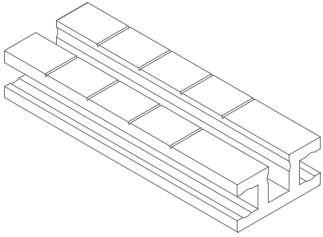

Connection components

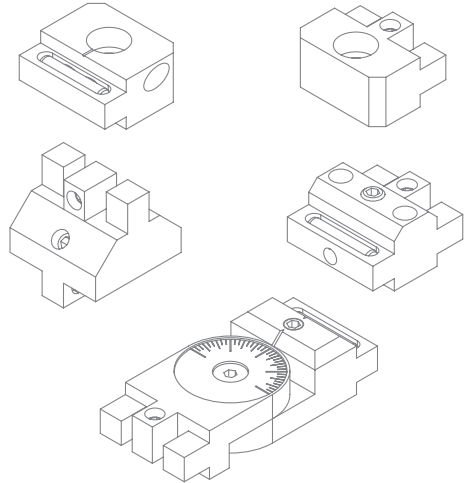

Positioning components

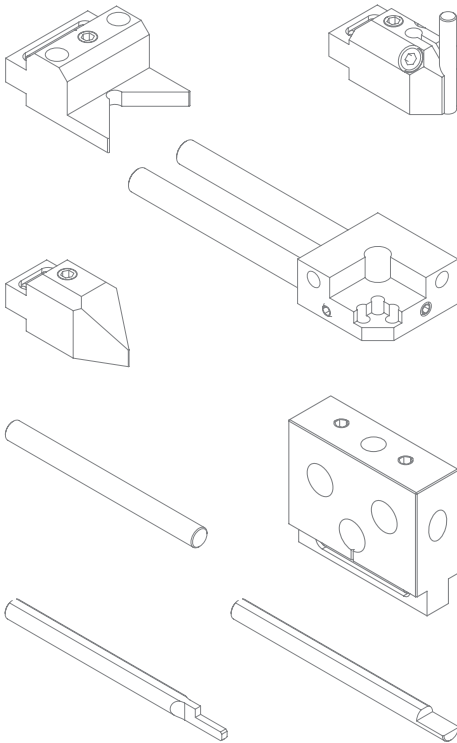

Fixing components

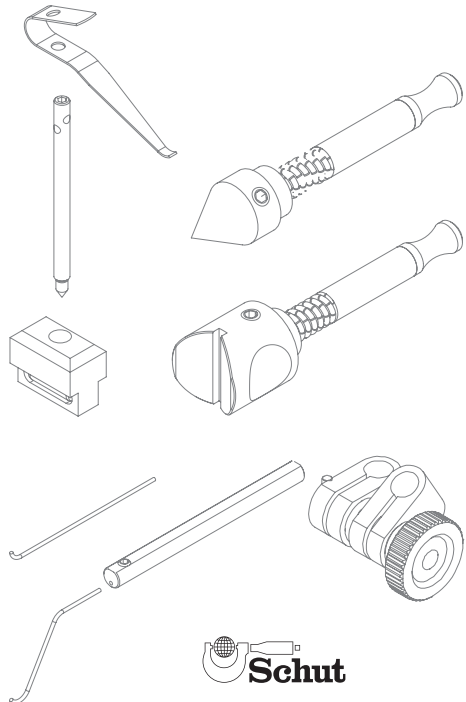

Mirrors

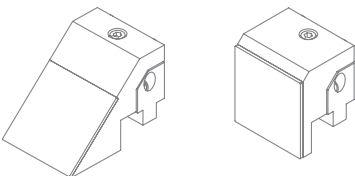

DF components – bars

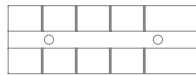
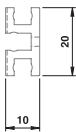
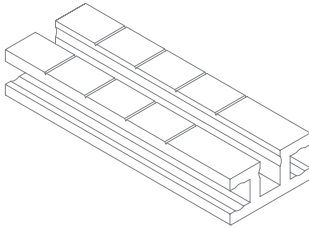

Length mm	Item No.	Price EUR	Item No.	Price EUR
	Black:		Silver:	
56	717.015	23.00	717.059	23.00
88	717.016	23.00	717.060	23.00
110	717.097	28.00	717.098	28.00
120	717.017	28.00	717.061	28.00
152	717.027	28.00	717.071	28.00
160	717.018	28.00	717.062	28.00
184	717.019	28.00	717.063	28.00
210	717.020	37.00	717.064	37.00
216	717.021	37.00	717.065	37.00
246	717.022	37.00	717.066	37.00
260	717.023	37.00	717.067	37.00
310	717.024	48.00	717.068	48.00
344	717.026	48.00	717.070	48.00
460	717.025	48.00	717.069	48.00

DF components – connection components

Item No.	Description	Price EUR
380.301	Distance tube with stop pattern 16	3.40
380.304	Distance tube with stop pattern 25	4.10
717.044	Screw and adapter pattern 16	5.00
717.008	Screw mounting tool	8.00

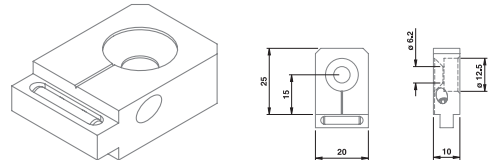
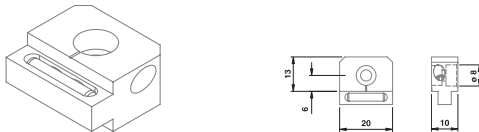
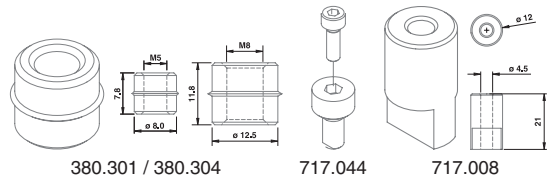

Item No.	Description	Price EUR
717.033	Mounting block side pattern 16 Black	26.00
717.043	Mounting block side pattern 16 Silver	26.00

Item No.	Description	Price EUR
717.034	Mounting block side pattern 25 Black	26.00
717.050	Mounting block side pattern 25 Silver	26.00

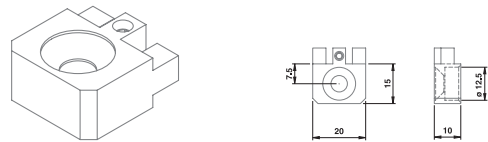
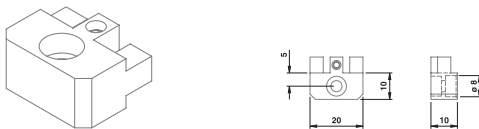

Item No.	Description	Price EUR
717.028	Mounting block end pattern 16 Black	23.00
717.072	Mounting block end pattern 16 Silver	23.00

Item No.	Description	Price EUR
717.035	Mounting block end pattern 25 Black	23.00
717.056	Mounting block end pattern 25 Silver	23.00

DF components – connection components (continued)

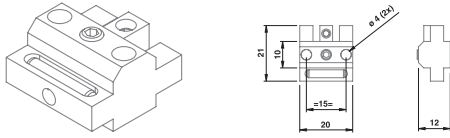

Item No.	Description	Price EUR
717.029	Mounting block perpendicular Black	29.00
717.073	Mounting block perpendicular Silver	29.00

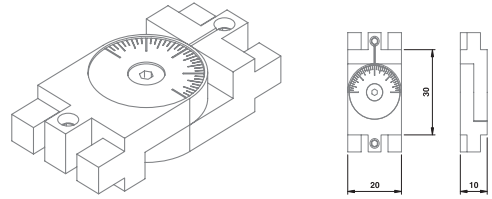

Item No.	Description	Price EUR
717.047	Hinge end Black	50.00
717.085	Hinge end Silver	50.00

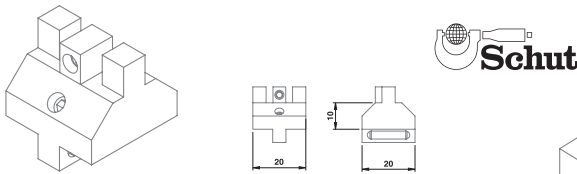

Item No.	Description	Price EUR
717.039	Mounting block V perpendicular Black	27.00
717.080	Mounting block V perpendicular Silver	27.00

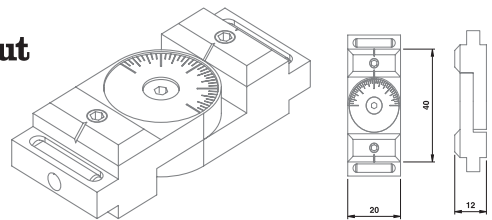

Item No.	Description	Price EUR
717.048	Hinge side Black	70.00
717.086	Hinge side Silver	70.00

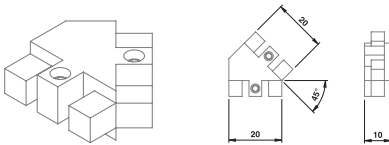

Item No.	Description	Price EUR
717.032	Mounting block 45° Black	21.00
717.076	Mounting block 45° Silver	21.00

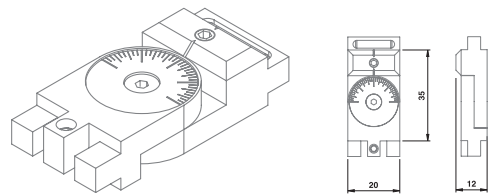

Item No.	Description	Price EUR
717.049	Hinge combi Black	60.00
717.087	Hinge combi Silver	60.00

DF components – positioning components

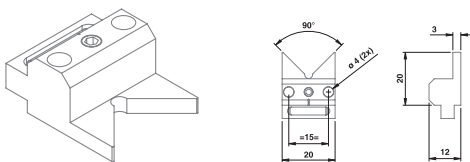

Item No.	Description	Price EUR
717.042	V-block 90° Black	29.00
717.083	V-block 90° Silver	29.00

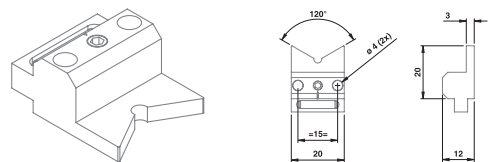

Item No.	Description	Price EUR
717.040	V-block 120° Black	29.00
717.081	V-block 120° Silver	29.00

DF components – positioning components (continued)

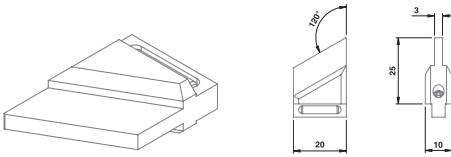

Item No.	Description	Price EUR
717.041	V-block half 120° Black	25.00
717.082	V-block half 120° Silver	25.00

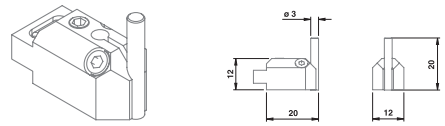

Item No.	Description	Price EUR
717.099	Anvil with shaft \varnothing 3 mm Black	47.00
717.100	Anvil with shaft \varnothing 3 mm Silver	47.00

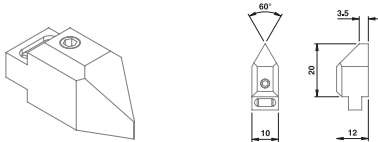

Item No.	Description	Price EUR
717.031	One point anvil long Black	23.00
717.075	One point anvil long Silver	23.00



Item No.	Description	Price EUR
717.030	One point anvil Black	21.00
717.074	One point anvil Silver	21.00

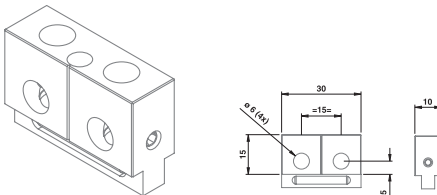

Item No.	Description	Price EUR
717.037	Mounting block for 2 shafts Black	29.00
717.078	Mounting block for 2 shafts Silver	29.00

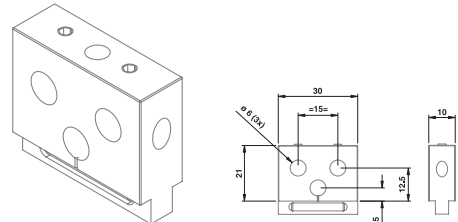

Item No.	Description	Price EUR
717.038	Mounting block for 3 shafts Black	30.00
717.079	Mounting block for 3 shafts Silver	30.00

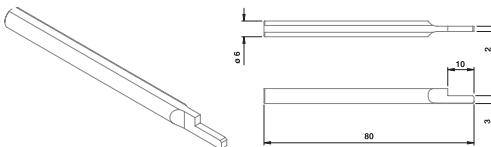

Item No.	Description	Price EUR
717.005	Support shaft 2 x 10 mm	9.00

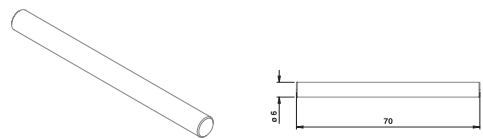

Item No.	Description	Price EUR
717.003	Shaft \varnothing 6 x 70 mm	2.00

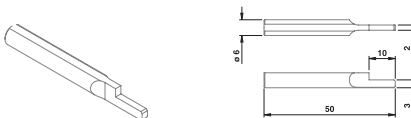

Item No.	Description	Price EUR
717.007	Support shaft 2 x 10 mm	10.00

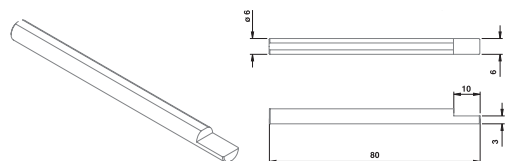

Item No.	Description	Price EUR
717.006	Support shaft 6 x 10 mm	8.00

DF components – fixing components (continued)

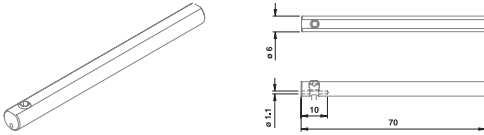

Item No.	Description	Price EUR
717.051	Holder for clamping spring	9.00

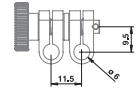
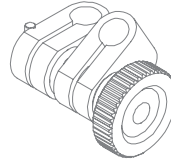

Item No.	Description	Price EUR
717.101	Clamp \varnothing 6 mm	17.00

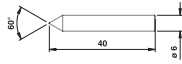
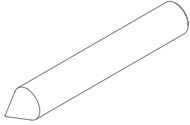

Item No.	Description	Price EUR
717.009	Center shaft \varnothing 6 mm, 60°	3.00

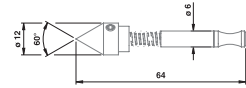
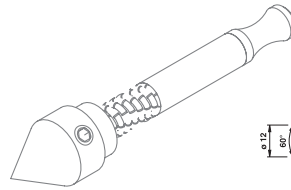

Item No.	Description	Price EUR
717.054	Center unit \varnothing 12 mm, 60°	28.00

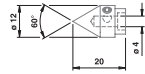
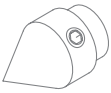

Item No.	Description	Price EUR
717.052	Center point \varnothing 12 mm, 60°	12.00

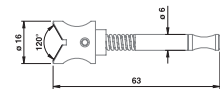
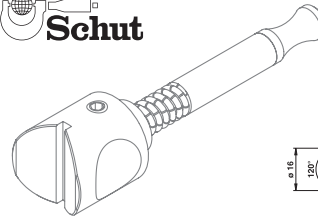

Item No.	Description	Price EUR
717.053	V-shaft \varnothing 16 mm, 120°	17.00

Item No.	Description	Price EUR
717.055	V-unit \varnothing 16 mm, 120°	33.00

DF components – mirrors

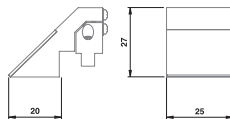
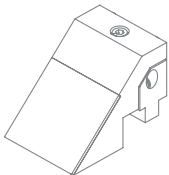

Item No.	Description	Price EUR
717.091	Mirror 45° 25 x 25 mm Black	79.00
717.092	Mirror 45° 25 x 25 mm Silver	79.00

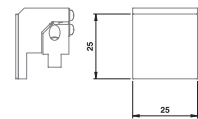
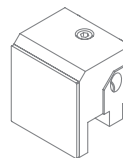

Item No.	Description	Price EUR
717.093	Mirror 90° 25 x 25 mm Black	77.00
717.094	Mirror 90° 25 x 25 mm Silver	77.00

Alufix fixture system

Alufix is a flexible fixture system made of high-tensile aluminum, also used in the aerospace industry due to its high clamping force. It is designed in cooperation with the automotive industry, rendering unlimited possibilities.

Applications of Alufix are for example:

- Product fixtures for coordinate measuring machines or other measuring systems (e.g. probe/dial indicator measuring systems and height gauges).
- Product fixtures for various mounting purposes.
- Product fixtures for various production applications like welding.

The great diversity enables a fixture for almost any product. E.g. Alufix is used in aerospace, plastics and car manufacturing industries.

Some advantages of the Alufix system:

- Alufix can save time and money, because the fixtures are quick and easy to assemble.
- All components are re-usable.
- Aluminum has low weight and is corrosion free.

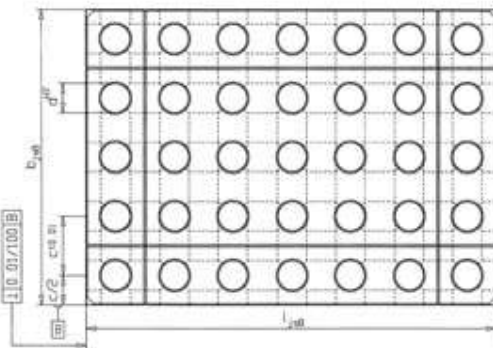

	Center distance c/mm	Bore diameter d/mm
Alufix 16	16	8
Alufix 25	25	12.5
Alufix 40	40	20
Alufix 50	50	25

The basis consists of a base plate or a “quader”. With all sorts of connecting elements you can fix other basic elements, building elements, vices, claw plates, prisms and various other Alufix elements.

Alufix is available in **Alufix 16** for fixturing small, light objects, **Alufix 25**, **Alufix 40**, **Alufix 50**, the **XL** and **XS** system and the **Fixinspect** system.

The center distances (c) of the bores are indicated by the type number, for example 25 mm for Alufix 25. The diameter (d) of the bores is half of this number, so 12.5H7. The various versions can be connected with positioning sleeves.

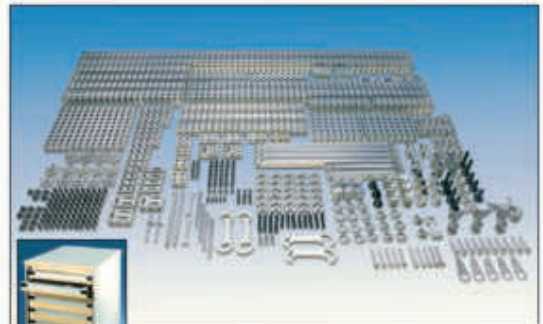

Example of an Alufix basic set: 438 pieces, delivery with workstation.

All Alufix parts are separately available, and can be assembled to create a product specific fixture. There are also sets of a more general composition.



Fixtures for height gauges can be rotated by 90° allowing 2 coordinates to be measured.

*Ask for
the detailed
brochure*

Alufix base plates

Alufix base plates serve as a basis for small to medium fixtures. They can be connected on all six sides using quick or screw connection elements and can therefore be used in an extremely flexible way.

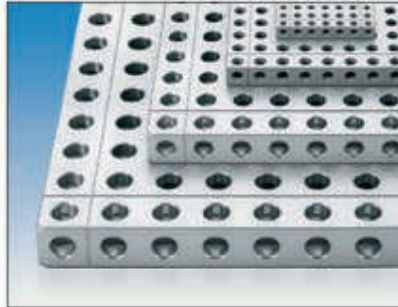

Various other sizes available.
Also available for Alufix 16, 40 and 50.



Item No.	Dimensions <i>l x w x h</i> /mm	Price EUR
Alufix 25:		
380.053	175 x 100 x 25	431.00
380.051	150 x 150 x 25	582.00
380.059	200 x 150 x 25	738.00
380.069	250 x 150 x 25	827.00
380.061	200 x 200 x 25	842.00
380.075	400 x 200 x 25	1,358.00
380.071	300 x 250 x 25	1,284.00
380.077	400 x 300 x 25	1,711.00
380.083	500 x 300 x 25	1,938.00

Alufix quaders

Solid Alufix classic bars, or also referred to as 'quaders', serve as connection between a base and workpiece support. They can be connected on six sides using quick or screw connection elements.

Quaders are available in single and double models.



Various other sizes available.
Also available for Alufix 16, 40 and 50.

Item No.	Dimensions <i>l x w x h</i> /mm	Price EUR
Alufix 25, single model:		
380.161	25 x 25 x 25	51.30
380.165	75 x 25 x 25	121.00
380.169	125 x 25 x 25	172.00
380.156	200 x 25 x 25	271.00
380.171	500 x 25 x 25	675.00
Alufix 25, double model:		
380.177	100 x 50 x 50	305.00
380.157	150 x 50 x 50	415.00
380.158	250 x 50 x 50	692.00
380.181	500 x 50 x 50	1,382.00

Alufix connection elements (quick coupling)

For connecting base plates, quaders and other elements.

With the positioning sleeves, the various Alufix systems can be connected.

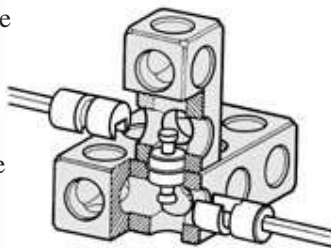

381.115

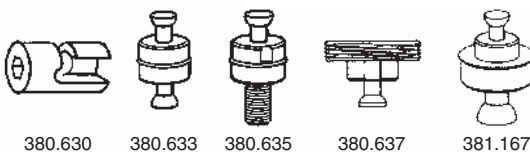

Also available for Alufix 16, 40 and 50.

Item No.	Description	Price EUR
Alufix 25:		
381.115	36 piece set	391.00
380.630	Lock	11.30
380.633	Twin bolt	8.50
380.635	Combi bolt	11.30
380.637	Bolt disk	15.40
381.167	Pos. sleeve 25/16	13.90

Alufix Light quaders and connection elements

To obtain weight reduction Alufix has designed this "light" version. The rectangular bars (quaders) are hollow instead of massive, and are available in single, double and triple models. On middle or large sized fixtures Alufix Light bars serve as a frame or as a connection between a base and the workpiece support.

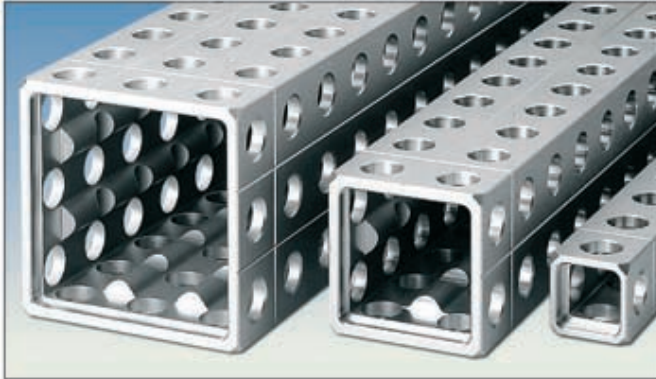

Quaders

Item No.	Dimensions <i>l x w x h</i> /mm	Price EUR
Alufix 25, single model:		
380.183	250 x 25 x 25	152.00
380.184	500 x 25 x 25	240.00
380.185	1000 x 25 x 25	423.00
380.781	2000 x 25 x 25	846.00
Alufix 25, double model:		
380.186	250 x 50 x 50	272.00
380.187	500 x 50 x 50	431.00
380.188	1000 x 50 x 50	778.00
380.790	2000 x 50 x 50	1,450.00
Alufix 25, triple model:		
380.806	250 x 75 x 75	402.00
380.807	500 x 75 x 75	634.00
380.809	1000 x 75 x 75	1,159.00
380.813	2000 x 75 x 75	2,168.00

Various other sizes available.
Also available for Alufix 40 and 50.

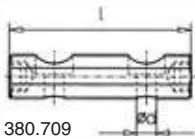

380.709

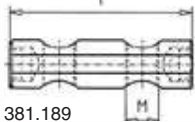

381.189

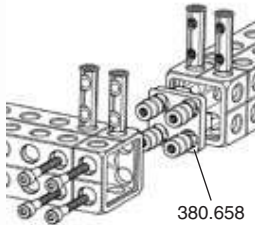

380.658



380.304

Couplings for Alufix 25, double model (*w x h = 50 x 50 mm*)

Item No.	Type	Price EUR
380.658	Single coupling	43.10
380.717	Double coupling	79.50

Also available for Alufix 40 and 50.

Struts for Alufix 25

Give extra support to frames and column type support points.



Item No.	Length/mm	Price EUR
381.123	125	85.60
381.124	250	165.00
380.715	500	232.00
380.716	750	279.00

Various other sizes available.
Also available for Alufix 40 and 50.

Screw connections

Item No.	Type	Price EUR
Alufix 25 crosspieces nut:		
380.328	M6 x 25 ¹	6.80
380.709	M6 x 50 ²	10.80
381.185	M6 x 75 ³	12.80
Alufix 25 crosspieces:		
380.325	M6 x 25 ¹	6.30
381.189	M6 x 50 ²	8.00
381.190	M6 x 75 ³	9.70
380.304	Positioning sleeve AF 25	4.10

¹Single, ²double or ³triple model.

Various other sizes available.

Also available for Alufix 16, 40 and 50.

Alufix positioning and fixing components

Alufix offers a large variety of positioning and fixing components. All of these components are compatible with Alufix 16, 25, 40 and 50.

Alufix 25 positioning components

Item No.	Angle	Price EUR
Prisms:		
380.225	90°	209.00
380.227	120°	255.00
Delta blocks:		
380.255	90°	141.00
380.261	120°	141.00

Various other sizes available.
Also available for Alufix 16, 40 and 50.

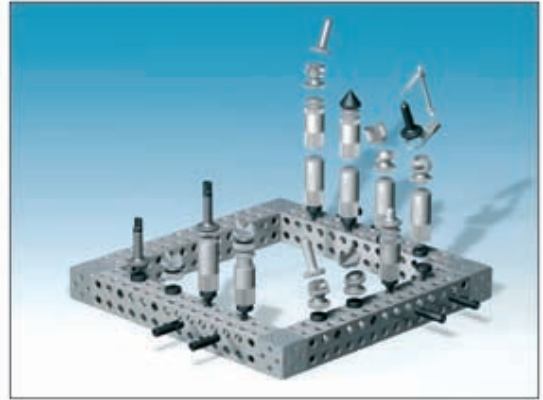
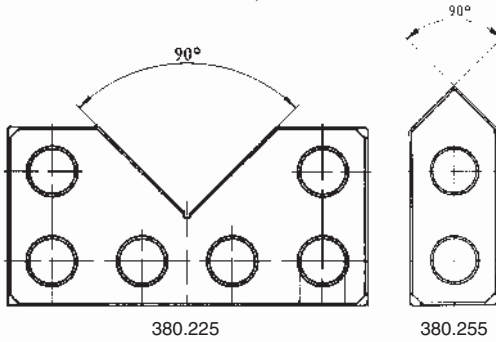

Alufix 25 fixing components

Item No.	Dimensions/mm	Price EUR
Clamping spring:		
380.704	$l = 35$	16.40
380.436	$l = 60$	16.40
380.901	$l = 105$	33.30
Stud for clamping spring:		
380.439	$h = 60$	18.50
380.442	$h = 60$	19.50
381.118	$h = 125$	35.90

Also available for Alufix 16, 40 and 50.

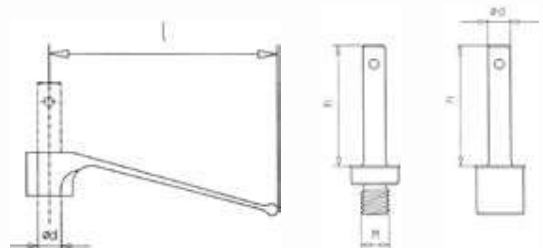
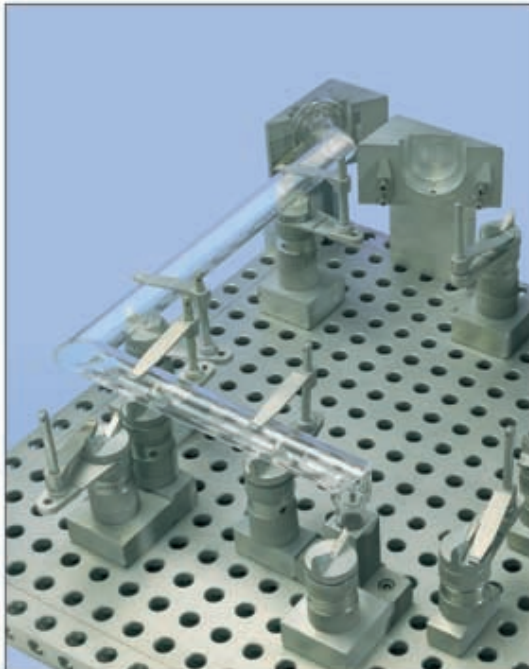

380.704/436/901

380.442/381.118 380.439

Alufix positioning and fixing components (continued)



381.162

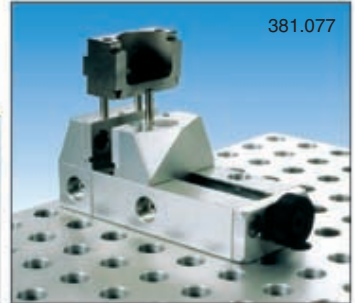

381.077

Item No.	Diameter/mm	Price EUR
For Alufix 25:		
381.162	50	427.00
381.075	80	438.00
381.078	125	743.00

Also other sizes available.

Item No.	Jaw width/mm	Price EUR
For Alufix 25:		
381.077	50	487.00
381.164	75	740.00
380.885	100	927.00

Also available with other jaw types.

Other Alufix systems

Alufix XL system

The XL system is especially developed for large products.

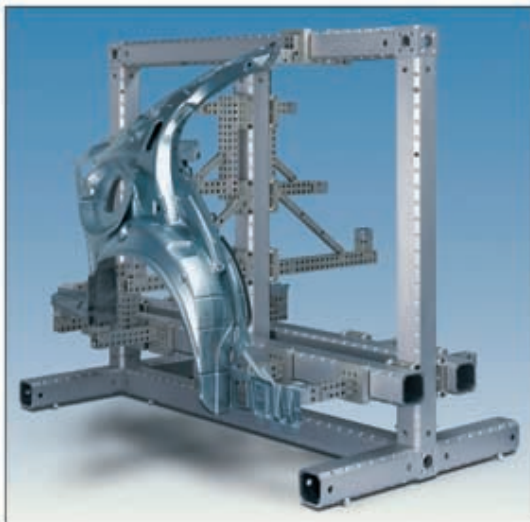

Alufix XS system

The XS system is developed for small components fixtures on for example optical measuring machines.



Alufix Fixinspect

Fixinspect measuring accessories are “half-ball” products with a tolerance of 0.02 mm made of anodized aluminum. When the surface of the ball is touch-probed, the position of the concerned hole or thread plug can be determined fast and easily.

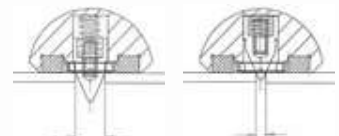

Ask for the detailed brochure

Probes and probe systems

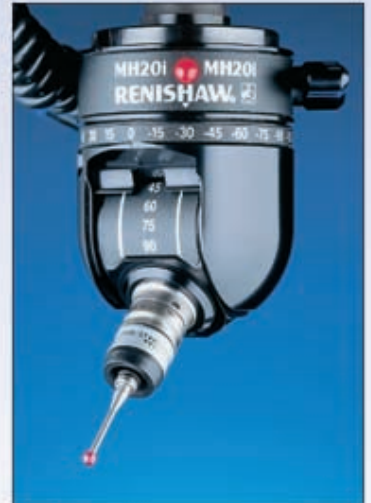
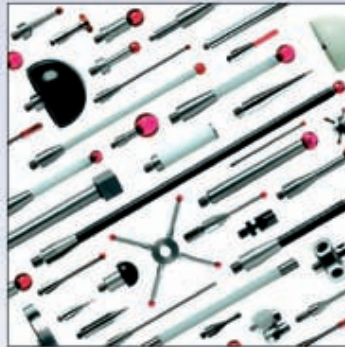

Ask for
the detailed
catalog

TP20 probe system

The TP20 probe consists of two parts; a probe body, and a detachable probe module that contains the kinematic touch sensor and carries the stylus assembly.

The probe body has a standard M8 x 1.25 screw connector, which enables simple fitment to all CMMs with a Renishaw standard probe head (including PH6). The body contains a



magnetic proximity switch to inhibit triggering of the probe during automatic module changing with the MCR20. (The TP20 NI, *Non-Inhibit*,

is not affected by magnetic fields and must be inhibited through software. The TP20 NI is available on request.)

The probe module is connected to the probe body by a highly repeatable magnetic kinematic coupling, which allows the automatic (CNC) or manual exchange of modules without the need to requalify the stylus tips.

Seven probe module options are available, each with a preset trigger force designed to ensure maximum probe performance when using different stylus configurations.

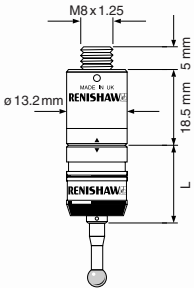
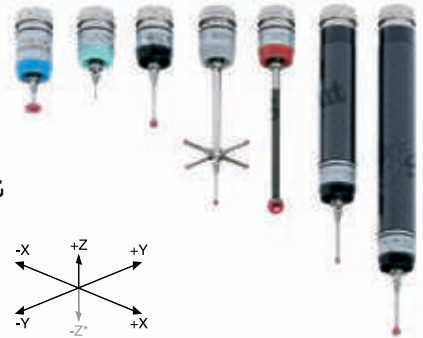
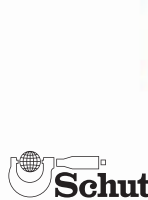

Module type ¹	Unidirectional repeatability (2σ)/μm	2D (XY) form meas. deviation PTV at 10 mm/μm	Trigger force/N (nominal at stylus tip)		Overall displacement (max at stylus tip)			Length L mm
			XY	Z	XY ²	+Z/mm	-Z/mm	
LF	0.35	±0.6	0.055	0.65	±14°	3.1	-	19.5
SF	0.35	±0.8	0.08	0.75	±14°	4.0	-	19.5
MF	0.5	±1.0	0.1	1.9	±14°	3.7	-	19.5
EF	0.65	±2.0	0.1	3.2	±14°	2.4	-	19.5
6-way	0.80	±1.5	0.14	1.6	±14°	4.5	-	24.5
EM1	0.35	±0.8	0.08	0.75	±14°	4.0	1.5	69.5
EM2	0.35	±0.8	0.08	0.75	±14°	4.0	-	94.5

¹ Probe length: 10 mm, except MF: 25 mm and EF: 50 mm.
² The probe module can get detached if this value is exceeded.

Item No.	Description	Price EUR
TP20 probe sets (incl. stylus tools/cleaning kit and manual):		
876.198	Probe body, probe module SF	2,220.00
876.244	Probe body, two probe modules SF	2,610.00
876.200	Probe body, probe modules SF and MF	2,610.10
<i>Other set compositions are available on request.</i>		
876.180	Probe module LF: with low force (green)	984.40
876.170	Probe module SF: with standard force (black)	894.90
876.171	Probe module MF: with medium force (gray)	894.90
876.172	Probe module EF: with extended force (brown)	921.70
876.194	Probe module 6W: 6-way (blue)	1,163.30
876.190	Extension module EM1 (standard force)	1,081.30
876.195	Extension module EM2 (standard force)	1,111.10
876.168	CK200 cleaning kit	11.00

PH6 Fixed Probe Head

The PH6 is a compact, vertical probe head for a single probe, with a fixed cable. The correct shank with cable combination must be chosen to suit the mounting features of your CMM. Many combinations are possible and available on request.

- Weight: 48 g (without shank and cable).
- Probe status identification: 1 LED.
- Cable connection: fixed cable (specify on order).
- Probe mounting: M8 thread.



Item No.	Description	Price EUR
876.061 ¹	PH6 Fixed Probe Head	285.90

¹ Equipped with PL1 cable (0.71 m) and MS1/T shank (ø9.500-9.512 mm).

Qualification spheres

- Ball: ø8 or ø25 mm, made of ceramics.
- Delivery with a measuring report.

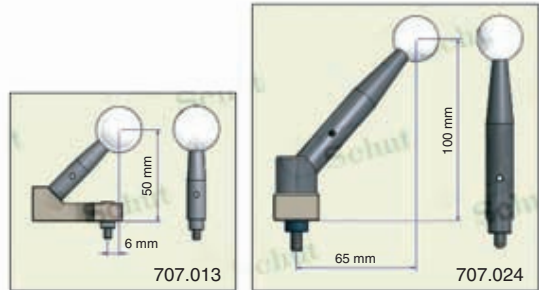

Item No.	Description	Price EUR
Qualification sphere ø8 mm:		
707.025	For DeMeet-220	468.00
707.026	For DeMeet-4xx/705	446.00
Qualification sphere ø25 mm:		
707.013	For DeMeet-220	360.00
707.024	For DeMeet-4xx/705	380.00
707.008	Ball only; M6 external thread	280.00

MCR20 Probe Module Changing Rack

The MCR20 is designed to securely hold up to six probe modules for automatic (CNC) changing and to protect them from airborne contaminants which may be present in the working environment.

- Height:
876.205: 145 mm,
635.141: 108.5 mm,
635.140: 110.5 mm.
- Capacity for 6 TP20 modules.
- Inhibit range: 50 mm.
- Delivery with base, without probe modules.

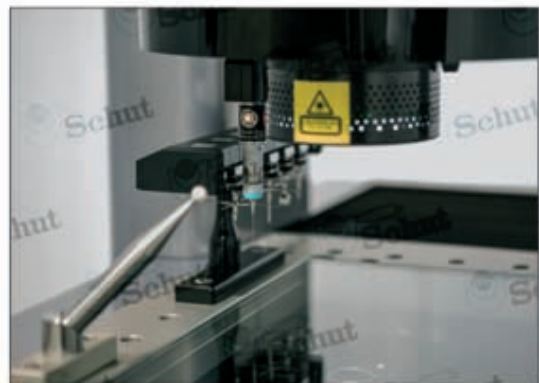
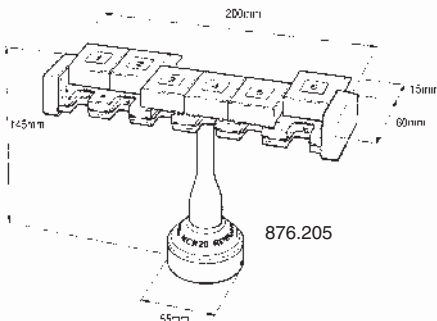

Item No.	Description	Price EUR
876.205	MCR20	2,237.00
635.141	MCR20 DeMeet-220	2,530.00
635.140	MCR20 DeMeet-4xx/705	2,530.00

Probes and accessories

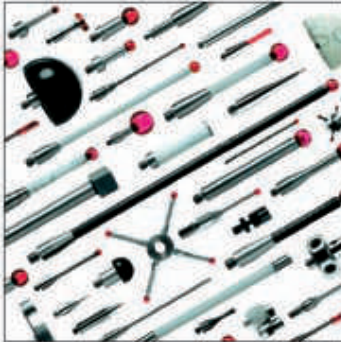

The element of the product to be measured determines the type and length of the probe. Maximum rigidity of the stem and perfect roundness of the ball are very important.

Only the M2 styli of the Renishaw probe program have been included in this catalog. M3, M4 and M5 are also available on request. The M2 probes are primarily suitable for the TP2, TP20 and TP200 probe systems.

Choosing probes for inspections

In order to maximize the accuracy of the main part of the probe applications, we advise you to use:

- the shortest and stiffest probes possible; the more the probe bends or deviates, the lower the measuring accuracy.
- the largest possible probe ball; the bigger the probe ball, the greater the free space between the ball and the stem and the smaller the effect of the surface condition of the product that has to be measured.
- as little extensions as possible; every connection introduces a potential diffraction or deviation.

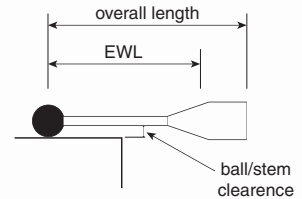

Ruby ball styli with stainless steel stem and thread M2

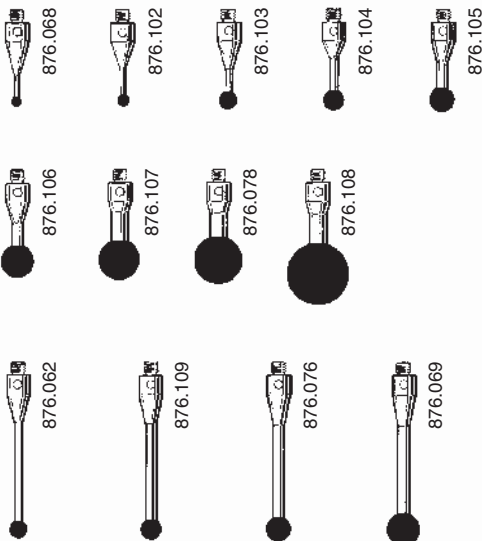

Item No.	Ball ϕ /mm	EWL* mm	Weight g	Price EUR
Total length* 10 mm:				
876.068	1	4.5	0.3	28.60
876.102	1.5	4.5	0.3	23.00
876.103	2	6	0.3	20.00
876.104	2.5	6	0.3	21.20
876.105	3	7.5	0.4	23.20
876.106	4	10	0.4	24.40
876.107	5	10	0.7	31.90
876.078	6	10	0.9	35.10
Total length* 11 mm:				
876.108	8	11	1.5	65.30
Total length* 20 mm:				
876.062	2	14	0.4	22.50
876.109	2.5	14	0.4	23.10
876.076	3	17.5	0.5	24.20
876.069	4	20.2	0.6	25.30

* Total length: from the base of the stem up to the center of the ball. EWL: effective working length.

Probes and accessories (continued)

Ruby ball styli with tungsten carbide stem and thread M2

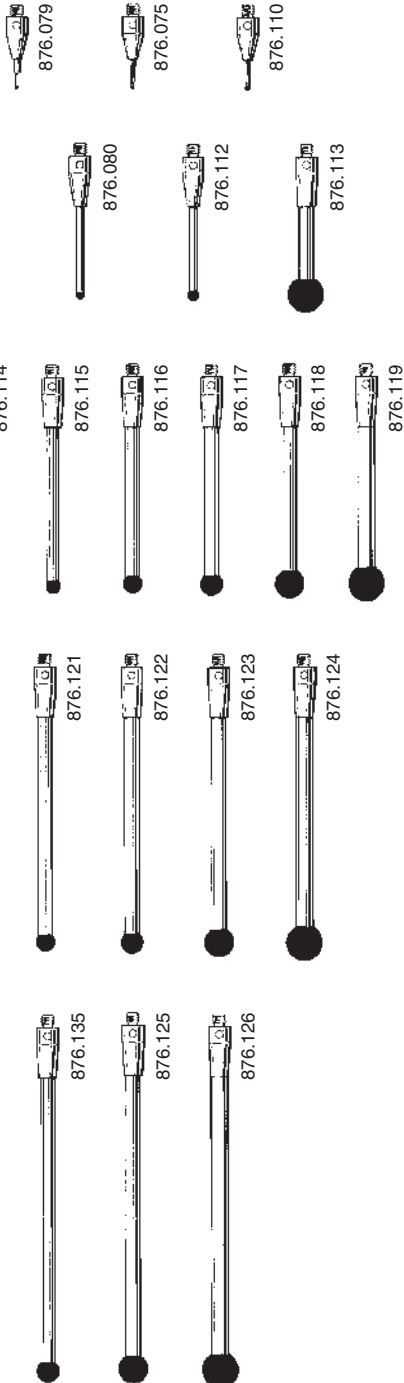

Item No.	Ball ø/mm	EWL* mm	Weight g	Price EUR
Total length* 10 mm:				
876.079	0.3	2	0.3	119.30
876.075	0.5	3	0.3	119.20
876.110	0.7	4	0.3	99.60
Total length* 20 mm:				
876.111	1	7	0.5	47.70
876.080	1	12.5	0.41	58.60
876.112	1.5	15	1.98	58.60
876.113	5	20	1.98	64.10
Total length* 30 mm:				
876.101	1	20.5	0.4	77.00
876.114	1.5	25	0.58	64.10
876.115	2	25	0.99	58.60
876.116	2.5	25	1.48	58.60
876.117	3	25	1.49	64.10
876.118	4	30	1.57	64.10
876.119	5	30	2.57	64.10
Total length* 40 mm:				
876.120	2	35	1.29	64.10
876.121	2.5	35	1.95	64.10
876.122	3	35	1.97	68.70
876.123	4	40	2.04	68.70
876.124	5	40	3.17	68.70
Total length* 50 mm:				
876.135	3	42.5	2.44	68.70
876.125	4	50	2.52	68.70
876.126	5	50	3.75	68.70

* Total length: from the base of the stem up to the center of the ball. EWL: effective working length.



Probes and accessories (continued)

Ruby ball styli with ceramic stem and thread M2, total length¹ 50 mm

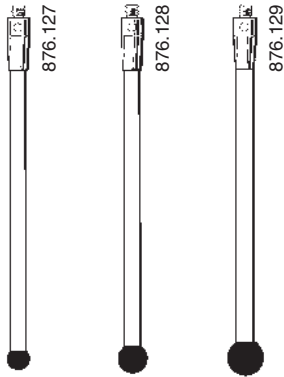

Ruby ball styli with carbon fiber stem and thread M2, total length¹ 50 mm

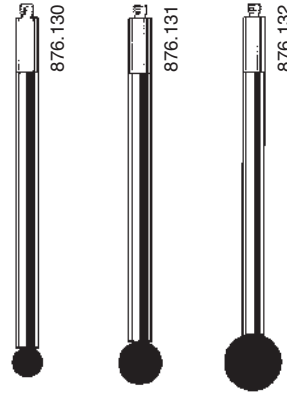

Item No.	Ball ø/mm	EWL ¹ mm	Weight g	Price EUR
876.127	3	42.5	0.83	75.10
876.128	4	50	0.91	75.10
876.129	5	50	1.31	75.10

Item No.	Ball ø/mm	EWL ¹ mm	Weight g	Price EUR
876.130	4	50.5	1	90.80
876.131	5	50.5	1.1	94.20
876.132	6	50.5	1.2	97.50

¹ Total length: from the base of the stem up to the center of the ball. EWL: effective working length.

Star styli (fixed) with thread M2

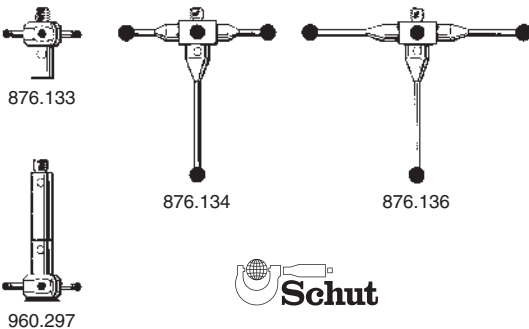

Item No.	Ball ø/mm	Work ² ø/mm	Weight g	Price EUR
876.133	1	10	0.5	163.80
876.134	2	20	1.3	124.80
876.136	2	30	1.8	119.40
960.297	1	11	1.2	278.00

² Span (center distance).

Disc styli with thread M2

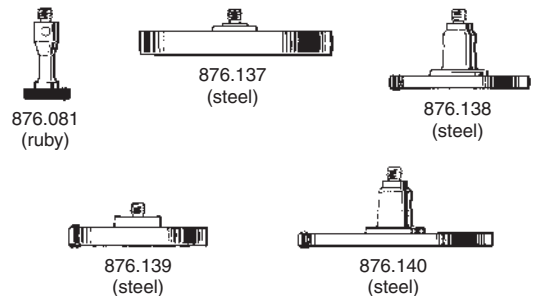

Item No.	Disc ø/mm	Disc thick- ness/mm	Weight g	Price EUR
876.081	6	2 ³	0.6	63.50
876.137	25	3	3.8	88.50
876.138	18	2.5 ³	3	105.80
876.139	18	3 ³	2.7	98.30
876.140	25	2.5 ³	4	105.80

³ Size is incl. ball probe on the disc.

Probes and accessories (continued)

Cylinder styli with thread M2

Item No.	Cylinder ø/mm	Total length ¹ /mm	EWL ¹ mm	Weight g	Price EUR
876.141	1.5	11	1.5	0.3	17.60
876.142	3	13	3.8	0.6	17.60
876.073	1	15	8	0.3	248.50
876.143	1.5	15	8.5	0.3	218.10
876.144	2	20	7.2	0.5	163.80
876.145	4	20	10	0.9	199.80
960.296 ²	8	23	5	4.5	60.00
842.301	0.2	26	3	0.35	222.00

¹ Total length: from the base of the stem up to the center of the ball.
EWL: effective working length.

² Radius bottom side 40 mm.

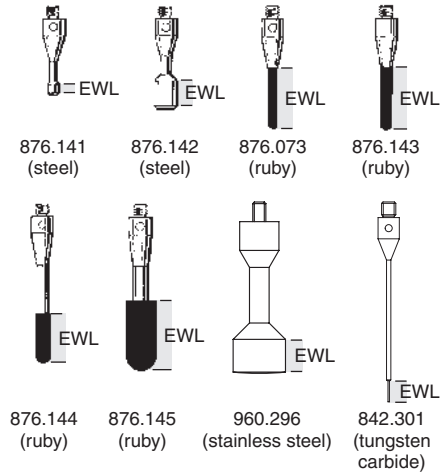

Parallel hemispherical ended styli (tungsten carbide) with thread M2

Item No.	Cylinder ø/mm	Total length*/mm	EWL* mm	Weight g	Price EUR
876.146	0.3	10.2	2.7	0.3	178.80
876.147	0.5	15.3	7.8	0.3	172.30
876.148	1	35.5	29.8	0.7	142.70
876.149	1.5	15.8	8.3	0.6	128.00
876.150	2	16	8.5	0.8	128.00
876.151	2	40	32	2	77.30
876.152	3	22.5	22.5	2	128.00

* Total length: from the base of the stem up to the center of the ball.
EWL: effective working length.

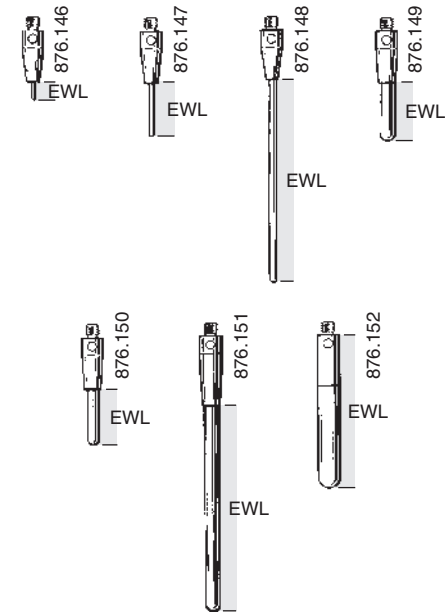

Special purpose styli with thread M2

Item No.	Length mm	Weight g	Material	Price EUR
876.160	15	0.7	stainless steel	22.80
876.161	10	0.7	tungsten carbide	79.80
876.162	11	3.3	ceramic	251.20

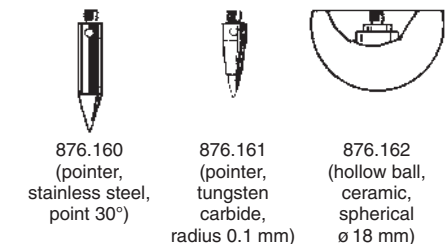

Probes and accessories (continued)

Stylus extensions with thread M2

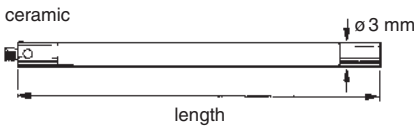
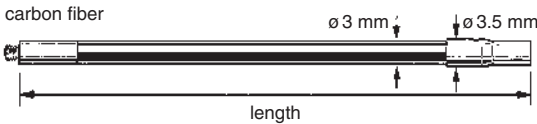
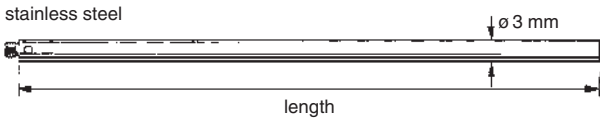

Item No.	Length mm	Weight g	Price EUR
Stainless steel:			
876.067	5	0.2	9.80
876.077	10	0.4	11.50
876.070	20	0.9	12.50
876.164	30	1.4	14.20
876.165	40	1.8	16.00
Carbon fiber:			
876.153	40	0.9	84.10
876.154	50	1	87.40
876.155	70	1.3	90.80
876.156	90	1.5	94.20
Ceramic:			
876.157	30	0.97	66.00
876.158	40	1.22	68.70
876.159	50	1.51	71.50

Stylus knuckles to put the probe in any desired position

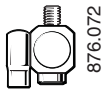

Item No.	Thread	EWL* mm	Center offset/mm	Weight g	Price EUR
876.072	M2	8	4.5	1.6	52.80
876.087	M2	16.5	-	1.3	62.80

* EWL: effective working length.

Stylus centers for a maximum of 5 styli



876.071
4-way:
3 side (120°)
1 bottom



876.064
5-way:
4 side (90°)
1 bottom

Item No.	Thread	EWL* mm	Center size/mm	Weight g	Price EUR
876.071	M2	7.5	7.5	1.1	69.60
876.064	M2	8	7.5	0.8	40.00

* EWL: effective working length.

Adapters (stainless steel)



876.074



876.065

Item No.	Thread external/internal	Length mm	Weight g	Price EUR
876.074	M2/M3	7	0.4	10.80
876.065	M3/M2	5	0.6	9.43

Styli tool for fitting styli to probe modules, couplings and extentions



876.166

Item No.	Description	Price EUR
876.166	Styli tool for M2 and M3 threaded styli	7.85

- A**
- Absolute
 - calipers 32-33, 36, 38, 41, 45, 54-56, 59
 - depth calipers 82
 - dial indicators 205, 208-211, 214
 - internal measuring instruments 161
 - micrometers 91, 96-97
 - probes 254
 - three-point internal micrometers 157
 - Alesometer three-point internal micrometers 153-155
 - Alignment tools 333
 - Alufix fixture system 508-512
 - basic sets for DeMeet 498
 - Angle blocks (cast iron) 296
 - Angle gauge blocks 363-364
 - Angle gauges 385
 - Angle plates (cast iron) 297-298
 - Anvils for micrometers 106
- B**
- Backs for dial indicators 232
 - Ball attachments for micrometers 132-133
 - Ball micrometers 126
 - Bases for dial indicator stands 264, 268
 - Beam compasses 437
 - Bench centers 278-281
 - Fisso 281
 - Bevel protractors (see Protractors) 323-330
 - Beveled edge squares 309
 - Beveled straight edges 321
 - Bore gauges (2-point) 159-161, 163-167, 171-177, 179-186, 199-202
(see Internal measuring instruments)
 - Bore gauges (3-point) 162
(see Internal measuring instruments)
 - Bore micrometers (2-point) 171-175
(see Internal micrometers)
 - Bore micrometers (3-point) 141-158
(see Three-point internal micrometers)
 - Borematic three-point internal micrometers 157
 - Bridge-type straight edges 320
- C**
- Caliper compasses 440
 - Calipers 32-62, 64-71, 386, 436
 - absolute 32-33, 36, 38, 41, 45, 54-56, 59
 - Bluetooth 42
 - carbon 42, 57, 60
 - digital 32-52, 54-62, 65, 386
 - for brake discs 53
 - for center distances 46, 54
 - for gear tooth thickness 52
 - for groove measurements 47-50, 55, 68
 - for internal measurements 47-50, 53, 55
 - for large measuring ranges 56-62, 69-71
 - for left-handers 32, 66-67
 - for scribing 46, 54, 436
 - for tube wall thickness 51, 55
 - for welding seams 386
 - IP54 38-39
 - IP65 57
 - IP66 60
 - IP67 41-45, 54-55, 58-59
 - Mitutoyo 41, 45, 54-55, 59-60, 64, 67
 - plastic 65
 - solar 35, 41
 - TESA 40, 44, 58, 64, 68
 - tolerance function 36
 - universal 61-62
 - with dial 64-65
 - with high resolution 35
 - with pointed measuring faces 51
 - with pointed measuring jaws 47, 54
 - with prismatic anvil 52
 - with slidable measuring jaws 46, 54
 - Calipers accessories 40, 44, 63, 72-75, 362
 - depth measuring bases 40, 44, 73-74
 - digital protractors 75
 - inspection sets 73-74, 362
 - probes 63, 72
 - soft cases 75
 - Calipers DIN 862 31
 - Calipers in sets 75
 - Cases for squares 302, 305
 - Center gauges 384
 - Center instruments 241-242
 - Center squares 440
 - Centering device for Imicro internal micrometers 148
 - Ceramic
 - gauge blocks 355-357, 361-362
 - parallels 313
 - squares 300
 - straight edges 313
 - surface plates 284
 - Circular spirit levels 341
 - Circumference tapes 428-429
 - Clamping bushes for dial indicators/probes 255
 - Clamping tables (cast iron) 297
 - Cleaner for surface plates 285, 459
 - Clinobevel digital clinometer 334
 - Clinometers 330-335
 - digital 331-334
 - magnetic 330-332
 - Clinometers DIN 877 322
 - Coating thickness gauges 469-470
 - eddy current 469-470
 - electro-magnetic 469-470
 - Combination bevel protractors 328
 - Compasses 437-440
 - Conical plug gauges 383
 - Construction systems 256-260, 418, 500-512
 - Alufix 508-512
 - DF 418, 500-507
 - MF 256-260
 - Contact points for dial indicators/probes 227-229
 - Contact tachometers 475-476
 - Contact thermometers 471
 - Contourmeters 167

- Convertor conversion table mm/inch 133, 387
 Coolant hoses with magnetic base 270
Coolant Proof
 – calipers 45, 54-55
 – depth calipers 82
 – micrometers 96, 127-128
 – scale units 427
 Coordinate measuring machines DeMeet 490-496
 – accessories 497-499
 – fixture systems basic sets 498, 501
 Covers for surface plates 282
 Crankpin levels 340
 Crankshaft meters 177
 Crankshaft spirit levels 339
 Cylindrical squares (steel) 298

D
 D/RS Instrumentbox 485
 DeMeet 3D CNC measuring machines 490-496
 – accessories 497-499
 – fixture systems basic sets 498, 501
 Depth calipers 76-83
 – absolute 82
 – digital 76, 79, 82
 – for keyway depths 83
 – IP67 79, 82
 – Mitutoyo 82
 – TESA 79-80
 Depth dial indicators Käfer 83
 Depth gauges 76-86
 – absolute 82
 – digital 76, 79, 82-84, 86
 – for keyway depths 83
 – IP67 79, 82
 – Käfer 83
 – Mitutoyo 82, 86
 – TESA 79-80, 86
 – with dial 83
 Depth measuring bases
 – for calipers 40, 44, 73-74
 – for dial indicators 83, 229
 Depth micrometers 84-86
 – digital 84, 86
 – IP65 84
 – Mitutoyo 86
 – TESA 86
 Depth micrometers DIN 863 87
 DF fixture system 418, 500-507
 – basic sets for DeMeet 498, 501
 Dial calipers 64-65
 Dial gauges (see Dial indicators) 204-226
 Dial indicator stands 262-269, 274-275
 – Fisso 266-269
 Dial indicator stands accessories 264, 268-269
 Dial indicator tester Peacock 232
 Dial indicators 204-226
 – absolute 205, 208-211, 214
 – Bluetooth 205
 – digital 204-215
 – horizontal 207
 – IP5x 206, 213, 217, 222
 – IP6x 210, 212-213
 – Käfer 223-224
 – Magnescale 215
 – Mitutoyo 208-211, 214, 221
 – Peacock 219-220
 – solar 208
 – TESA 212-213, 222
 – with back plunger 220
 – with calculation function 207, 211
 – with determination of the reversal point 205-206, 209, 212
 Dial indicators accessories 23, 83, 227-232
 – adapters 229
 – angle probes 231
 – backs 232
 – depth measuring bases 83, 229
 – inserts 227-229
 – retraction levers 23, 230
 – special probes 231
 – swivel-type probes 231
 Dial indicators DIN 878 203
 Dial test indicators 233-239
 – digital 233
 – Interapid 238
 – Käfer 239
 – Mitutoyo 235-236
 – Peacock 234
 – TESA 237
 Dial test indicators accessories 240-241
 Dial test indicators DIN 2270 203
 Digico dial indicators 212-213
Digimatic
 – calipers 41, 45, 54-55, 60
 – depth calipers 82
 – depth micrometers 86
 – dial indicators 208-211, 214
 – internal measuring instruments 161
 – micrometer heads 139
 – micrometers 91, 96-97, 127-128
 – SPC printer 486
 – USB interface 486
 Digital length measuring systems Magnescale 7-30
DIN standards
 – 2270 (dial test indicators) 203
 – 861 (gauge blocks): see ISO 3650 350
 – 862 (calipers) 31
 – 863 (micrometers) 87, 140
 – 866 (graduated rulers) 419
 – 874 (straight edges) 288
 – 875 (squares) 288
 – 876 (surface plates) 261, 288
 – 877 (clinometers/spirit levels) 322
 – 878 (dial indicators) 203
 – 879 (precision dial indicators) 203
 Distance meters 432-433
 – digital measuring wheels 432
 – laser 433

– Leica DISTO.....	433
DISTO laser distance meters.....	433
Dividers.....	437-440
Drill gauges.....	382
Dynamometers.....	476-479
– digital.....	479
– spring scales.....	479
– strain gauges.....	478
– torqueometers.....	476-477

E

Eddy current coating thickness gauges.....	469-470
Edge finders.....	30, 243-244
Electro-magnetic coating thickness gauges.....	469-470
Electronic indicators.....	246-249
Electronic scale with magnifier.....	405
Endoscopes.....	416
External measuring instruments	
.....	92-93, 97, 179, 185-202, 467-470
– digital.....	92-93, 97, 179, 186-187, 189, 191-193, 198
– eddy current.....	469-470
– electro-magnetic.....	469-470
– for tube wall thickness.....	185, 189-192, 196
– Interapid.....	196
– IP67.....	186, 189
– Käfer.....	193
– Kröplin.....	185-186, 189-191
– mini.....	97
– Mitutoyo.....	97
– Peacock.....	195-196
– TESA.....	202
– ultrasonic.....	467-468
– universal.....	196
External measuring instruments setting instruments...	168
Eye magnifiers.....	390

F

Feeler gauges.....	367-368
Feeler stock coils.....	368
Field of view qualifier.....	404, 497
Filetor thread table.....	133, 387
Fishtail gauges.....	384
Fisso	
– bench centers.....	281
– dial indicator stands.....	266-269
Fixture systems.....	418, 500-512
– Alufix.....	508-512
– DF.....	418, 500-507
Fixture systems basic sets for DeMeet.....	498, 501
Fixture systems custom-built.....	499
Flange squares.....	307
Folding magnifier.....	394
Frame spirit levels.....	337-338

G

Gauge blocks.....	351-359, 361-364
– angle.....	363-364
– ceramic.....	355-357, 361-362
– long.....	358-359

– steel.....	351-352, 358-359, 362-363
– tungsten carbide.....	353-354
Gauge blocks accessories.....	359-362
– gloves.....	361
– maintenance kits.....	362
– toggle clamps.....	359
Gauge blocks general information.....	350
Gauge blocks ISO 3650.....	350
Gauge blocks sets.....	351-359, 361-364
Gauges.....	178, 370-387
– angle.....	385
– cone plug gauges.....	383
– drill gauges.....	382
– flat plug gauges.....	383
– keyway depths.....	376
– limit.....	370-376, 381
– measuring wedges.....	382
– nozzle gauges.....	383
– radius/shape.....	385
– taper gauges.....	375
– telescopic.....	178
– thickness.....	387
– thread.....	377-381, 384
– thread cutting tool gauges.....	384
– thread jaw gauges.....	381
– twist drill grinding gauges.....	382
– welding seam.....	386
Gauges (probes).....	16-20, 23, 246, 250-254
– absolute.....	254
– DC analog.....	250
– IP5x.....	17-18, 251-252
– IP67.....	16, 20
– IP6x.....	17-19, 250-254
– Magnescale.....	16-20, 23
– TESA.....	250-252
Gauges measuring reports.....	370, 374, 377
Gear pitch micrometers.....	114, 128-129
Gear tooth thickness calipers.....	52
Glass rulers with magnifiers.....	404
Glass standard.....	404, 497
Gloves.....	361
Graduated rulers.....	404-405, 420-424
– aluminum.....	422-423
– electronic, with magnifier.....	405
– glass, with magnifiers.....	404
– self-adhesive.....	422-423
– steel.....	420-424
Graduated rulers DIN 866.....	419
Guide collars.....	134

H

Handles for pin gauges.....	372
Hardness testers.....	461, 463-466
– digital.....	461, 463-466
Hardness testers measuring stands.....	462
Head magnifiers.....	393
Height and scribing gauges.....	443-450
– Bluetooth.....	444
– digital.....	443-448

- Mitutoyo..... 447-448
 - Height gauges 451-458
 - digital..... 451-458
 - Mitutoyo..... 456-458
 - TESA..... 451-455
 - Height gauges accessories 459
 - digital protractors..... 459
 - Holtest three-point internal micrometers 156
 - Hygrometers (humidity meters) digital..... 474
- I**
- Imicro three-point internal micrometers ... 147-148, 151-152
 - Inclination (see Clinometers) 330-335
 - Induction blocks magnetic 292
 - Infrared thermometers digital..... 472
 - Inotest internal and external measuring instrument... 202
 - Inserts for dial indicators/probes..... 227-229
 - Inside calipers..... 47-50, 53, 55
 - Inspection sets for calipers 73-74, 362
 - Inspection sets for micrometers..... 133-134, 361-362
 - Inspection spirit levels..... 336-337, 339
 - Instrument interface/display..... 249, 483
 - Instruments sets 75
 - Intalometer three-point internal micrometers..... 149
 - Interapid
 - dial test indicators 238
 - external measuring instruments 196
 - internal measuring instruments..... 176
 - Interface boxes 483-485
 - Internal and external measuring instruments
 - (2-point)..... 199-202
 - TESA..... 202
 - Internal measuring instruments
 - (2-point)..... 159-161, 163-167, 171-177, 179-186, 199-202
 - absolute..... 161
 - crankshaft meters..... 177
 - digital..... 161, 167, 174, 179-180, 182, 184, 186
 - for internal grooves..... 175
 - for screw thread..... 173
 - Interapid 176
 - internal micrometers..... 171-175
 - IP53..... 161
 - IP67..... 182, 186
 - Kröplin..... 182-186
 - Mitutoyo..... 161
 - Peacock..... 160
 - Schwenk..... 163-167
 - stick micrometers 171-173
 - TESA..... 202
 - with interchangeable inserts..... 173
 - Internal measuring instruments (3-point)..... 162
 - digital..... 162
 - IP67..... 162
 - Kröplin..... 162
 - Internal measuring instruments
 - setting instruments 168-170
 - Internal micrometers (2-point) 171-175
 - digital..... 174
 - for internal grooves..... 175
 - for screw thread..... 173
 - stick micrometers 171-173
 - with interchangeable inserts..... 173
 - Internal micrometers (3-point) 141-158
 - (see Three-point internal micrometers)
 - Internal micrometers DIN 863 140
 - ISO 3650 (gauge blocks) 350
 - Isomaster
 - depth micrometers 86
 - micrometer heads 137
 - micrometers 100, 106, 130
- K**
- Käfer
- depth dial indicators 83
 - dial indicators 223-224
 - external measuring instruments 193
 - lever-type dial test indicators 239
 - precision dial indicators..... 224-225
 - saw tooth indicators 239
- Keyway depths
- depth calipers..... 83
 - gauges 376
 - measuring wedges 382
 - micrometers 122, 127
- Knife-edged straight edge 321
- Kröplin
- external measuring instruments... 185-186, 189-191
 - internal measuring instruments..... 162, 182-186
- L**
- Lapp and inspection plates..... 284
 - Laser alignment tools 333
 - Laser distance meters 433
 - Leica DISTO..... 433
 - Laser tachometers..... 475
 - LED lamp on magnetic stand 270
 - Left-handed calipers 32, 66-67
 - Left-handed micrometers..... 89, 98
 - Leica DISTO laser distance meters 433
 - Length measuring systems Magnescale 7-30
 - Levels (see Spirit levels) 336-341
 - Lever-type dial test indicators 233-239
 - digital..... 233
 - Interapid 238
 - Käfer 239
 - Mitutoyo..... 235-236
 - Peacock..... 234
 - TESA..... 237
 - Lever-type dial test indicators accessories 240-241
 - LH-600 height gauges 456-457
 - Limit micrometers 108, 129
 - Long-distance microscopes..... 397
- M**
- Magnescale detectors 10, 14, 19
 - MD (Magnescale)..... 14
 - MJ100/110 (Digiruler)..... 10

– MT12/13/14/20 (DT gauges)	19	Measuring wedges	382
– PL81/82 (Digiruler)	10	Measuring wheels digital	432
Magnescale digital dial indicators	215	MF measuring fixture system	256-260
Magnescale digital length measuring systems	7-30	Micro-Hite height gauges	451-453
Magnescale display units	24-29	Micromaster	
– LG20	24-25	– depth micrometers	86
– LH70/71	24-25	– micrometer heads	137
– LT10A	26	– micrometers	95, 106, 129-130
– LT11A	26	Micrometer heads	135-139
– LT20A	27	– digital	136-137, 139
– LT30	27	– IP65	136, 139
– LY71/72	28-29	– Mitutoyo	138-139
Magnescale display units supports	30	– TESA	137
Magnescale gauges	16-20	Micrometer heads DIN 863	87
– DF (Magnescale)	20	Micrometers	88-130
– DK (Magnescale)	16-18	– absolute	91, 96-97
– DT (Digiruler)	19	– Bluetooth	93
Magnescale MF10 Digital Tolerance Indicator	20	– digital	88-97, 105-106, 109-117, 119-123, 127-130
Magnescale multi-interface unit MG	21-22	– for brake discs	117
Magnescale position sensors	11, 14	– for can seams	126
– PH100/500 (reference point)	14	– for external gears	119, 128
– set K2	14	– for gear pitches	114, 128-129
– set P15/16 (zero point)	11	– for hubs	126
Magnescale scales	7-9, 11-13, 15	– for keyway depths	122, 127
– GB-ER (Magnescale)	8	– for large measuring ranges	103-106
– Laserscale	15	– for left-handers	89, 98
– Rolling Mill	15	– for paper	114, 118, 128
– SJ700A (Millman)	7	– for pitch diameters	123-125, 128, 130
– SL130 (Digiruler)	9	– for screw thread	123-125, 128, 130
– SL331 (Digiruler)	11	– for sheet metal	118
– SL700 (Digiruler)	15	– for soft materials	118, 128
– SmartSCALE	15	– for tube wall thickness	111-113, 128-129
– SR (Magnescale)	15	– for wires and balls	126
– SR118 (Magnescale)	12	– IP54	91-92, 95, 129-130
– SR-721SP (Magnescale)	13	– IP65	92-94, 96, 105, 109-113, 116-117, 119-121, 123, 127-128
Magnescale touch sensors (TS)	30	– large anvils	117
Magnetic holders	292	– limit	108, 129
Magnifiers	389-400, 406	– mini	107
Magnifiers accessories	404	– Mitutoyo	91, 96-97, 101-102, 127-128
Magnifying glasses	400	– TESA	95, 100, 106, 129-130
Maintenance kits for steel gauge blocks	362	– universal	112, 115, 128-129
Mandrels	376	– with counter	90
Marking calipers	436	– with deep throat	116-118
Marking compasses	437-440	– with dial indicator	104, 107-109, 129
Marking gauges	435-436	– with disk-shaped measuring faces ...	114, 118, 128-129
Measuring balls	363-364	– with interchangeable inserts	115, 119, 123-125, 128, 130
Measuring fixture system MF	256-260	– with lamellar measuring faces	122, 127
Measuring force indicators for micrometers	132	– with large measuring faces	114, 118, 128-129
Measuring instrument interfaces	249, 483-485	– with pin-shaped anvil	113
Measuring machines DeMeet	490-496	– with pointed measuring faces	117, 121, 127
– accessories	497-499	– with prismatic anvil	120, 127, 130
– fixture systems basic sets	498, 501	– with small measuring faces	110, 127, 129
Measuring pins	371-372	– with special measuring jaws	113
Measuring pins accessories	372	– with spherical measuring faces	111
Measuring staffs	404-405, 420-424	Micrometers accessories	120, 124, 131-134, 361-362
(see Graduated rulers)		– ball attachments	132-133
Measuring stands	271-273, 276-277, 462	– inspection sets	133-134, 361-362
– for hardness testers	462		
Measuring tables	276		

- measuring force indicators 132
- probes 133
- setting standards 120, 124, 131, 134
- stands 132
- Micrometers DIN 863 87
- Micrometers in sets 75
- Microscopes 393, 397, 401-403, 406-415
 - for long distances 397
 - pen-shaped 393
 - stereo 406-413
 - with camera 410-411, 413-415
 - with scales 397, 401-403
- Microscopes accessories 404
- Module calipers 52
- Monocular telescopes 392
- Morse taper gauges 375
- Mounting straight edges 318
- Multi-sensor measuring machines DeMeet 490-495

- N**
- Niveltronic electronic spirit levels 334
- Novometer contourmeters 167
- Nozzle gauges 383

- O**
- Objectives (stand microscopes) 402
- Optical flats 365-366
- Optical measuring machines DeMeet 490-495
- Outside micrometers (see Micrometers) 88-130

- P**
- Parallel blocks 296
- Parallels 312-314, 319
 - cast iron 319
 - ceramic 313
 - granite 314
 - steel 312
- Peacock
 - dial indicator tester 232
 - dial indicators 219-220
 - external measuring instruments 195-196
 - inserts for lever-type dial test indicators 234
 - internal measuring instruments 160
 - lever-type dial test indicators 234
- Pen microscopes 393
- Pin gauges 371-372
- Pin gauges accessories 372
- Pipe wall thickness gauges
 - calipers 51, 55
 - external measuring instruments ... 185, 189-192, 196
 - micrometers 111-113, 128-129
- PJ-A3000 profile projectors 417
- Plan parallel optical flats 362, 365-366
- Plastiform 418
- Plate thickness gauges 97, 179, 185-202
 - (see External measuring instruments)
- Plug gauges 370-373, 377-381, 383
 - conical 383
 - flat 383
 - limit 370-373, 381
 - thread 377-381
- Plug gauges for small bores 178
- Precision dial indicators 224-226
 - Käfer 224-225
 - Schwenk 226
 - TESA 226
- Precision dial indicators DIN 879 203
- Precision tapes 430-432
 - digital 432
- Preset (Z-axis setting gauges) 244
- Printer SPC Mitutoyo 486
- Probe systems Renishaw 514-520
- Probes 16-20, 23, 246, 250-254
 - absolute 254
 - DC analog 250
 - IP5x 17-18, 251-252
 - IP67 16, 20
 - IP6x 17-19, 250-254
 - Magnescale 16-20, 23
 - TESA 250-252
- Probes accessories 23, 227-231, 255
 - angle probes 231
 - inserts 227-229
 - retraction levers 23, 230
 - special probes 231
 - swivel-type probes 231
- Probes for calipers 63, 72
- Probes for micrometers 133
- Profile projectors Mitutoyo 417
- Protractors 75, 323-335, 459
 - clinometers 330-335
 - combination 328
 - digital 75, 323-325, 329-334, 459
 - for calipers and height gauges 75, 459

- Q**
- QM-Height height gauges 457-458
- Qualification spheres 497, 515
- Quick Mini quick thickness gauge 97
- Quick thickness gauges Mitutoyo 97

- R**
- Radius gauges 385
- Reference balls 497, 515
- Refractometers 481
- Remote Instrument Display 483
- Renishaw probe systems 514-520
- Retraction levers for dial indicators/probes 23, 230
- Ring gauges 377-381
- Roughness specimens 347-348
- Roughness specimens on wall chart 347
- Roughness testers 343-346
 - Mitutoyo Surftest 344-345
 - Surtronic Duo 343
 - TESA Rugosurf 346
- Rugosurf surface roughness testers 346
- Rulers (see Graduated rulers) 404-405, 420-424

- S**
- Saw tooth indicators 239
 - Scale magnifiers 395-399
 - Scale microscopes 397, 401-403
 - Scale units digital 425-427
 - IP66 427
 - IP67 426
 - Mitutoyo 427
 - TESA 426
 - Schwenk
 - circumference tapes 428-429
 - contourmeters 167
 - internal measuring instruments 163-167
 - precision dial indicators 226
 - Screw pitch gauges 387
 - Screw thread gauges 377-381, 384
 - Screw thread micrometers 123-125, 128, 130, 173
 - digital 123, 128, 130
 - for internal measurements 173
 - Screw thread micrometers setting standards 124
 - Screw thread tables 133, 387
 - Scriber points 437
 - Scribing calipers 46, 54, 436
 - Scribing compasses 437-440
 - Scribing tools 46, 54, 435-441, 443-450
 - caliper compasses 440
 - calipers 46, 54, 436
 - center squares 440
 - dividers 438-439
 - height gauges 443-450
 - marking gauges 435-436
 - scriber points 437
 - surface gauges 441
 - trammels 437
 - Select gauge blocks 352, 354, 356, 359
 - Setting level 329
 - Setting gauges Z-axis 244
 - Setting instruments (universal) 441
 - Setting instruments for
 - external measuring instruments 168
 - internal measuring instruments 168-170
 - stick micrometers 169
 - tools 245
 - Setting rings 373-374, 381
 - Setting standards for
 - micrometers 131, 134
 - micrometers with prismatic anvil 120
 - screw thread micrometers 124
 - Shape and radius gauge 385
 - Shore hardness testers 461-462
 - Sine bars 311
 - Sine plates 295
 - Smartbox interface 484
 - Soft cases for calipers 75
 - Solar calipers 35, 41
 - Sonarscopes 481
 - Sound level meters digital 480
 - SPC printer Mitutoyo 486
 - Spirit levels 330-341
 - clinometers 330-335
 - digital 331-334
 - with flat base 340
 - Spirit levels DIN 877 322
 - Spring scales digital 479
 - Square blocks granite 296
 - Squares 299-311
 - ceramic 300
 - granite 299
 - steel 301-311
 - with base 304-306
 - with heavy beam 307-308
 - Squares DIN 875 288
 - Squares wooden cases 302, 305
 - Stands for dial indicators 262-269, 271-277
 - Fisso 266-269
 - Stands for hardness testers 462
 - Stands for micrometers 132
 - Stands for surface plates 286-287
 - Stepped setting gauges 134
 - Stereo microscopes 406-413
 - with camera 410-411, 413
 - Stereo microscopes accessories 404, 411-413
 - Stethoscope 481
 - Stick micrometers 171-173
 - for screw thread 173
 - with interchangeable inserts 173
 - Stick micrometers setting instruments 169
 - Straight edges 312-321
 - aluminum 317, 319
 - bridge-type 320
 - cast iron 319-320
 - ceramic 313
 - for mounting 318
 - granite 314
 - knife-edged 321
 - steel 312, 315-316, 318, 321
 - triangular 320
 - Straight edges DIN 874 288
 - Strain gauges 478
 - Supports for Magnescale displays 30
 - Surface gauges 441
 - Surface plates 282-284, 459
 - cast iron 283
 - ceramic 284
 - granite 282, 459
 - Surface plates accessories 282, 285, 287, 459
 - cleaner 285, 459
 - covers 282
 - stands 287, 459
 - supports 285
 - Surface plates DIN 876 261, 288
 - Surface roughness testers 343-346
 - Mitutoyo SurfTest 344-345
 - Surtronic Duo 343
 - TESA Rugosurf 346
 - SurfTest surface roughness testers 344-345
 - Surtronic Duo surface roughness testers 343

- T**
- Tables 133, 387
 - Tachometers 475-476
 - contact 475-476
 - laser 475
 - Taper gauges 375
 - Telescopes monocular 392
 - Telescopic gauges 178
 - Telescopic mirrors/magnets 481
 - Telescopic scales 432
 - Terms of sales and delivery 529
 - TESA BPX44 488
 - TESA Link Connector 488
 - TESA Plastiform 418
 - TESA TWIN Station 488
 - TESA TWIN-Cal calipers IP67 44
 - TESA TWIN-T10 247
 - TESA-Hite height gauges 453-455
 - Tesamaster
 - micrometer heads 137
 - micrometers 100
 - Tesatronic electronic indicators 248
 - Thermal imager 473
 - Thermohygrograph digital 474
 - Thermohygrometers digital 474
 - Thermometers 471-474
 - contact 471
 - digital 471-474
 - infrared 472
 - Thickness gauges 387, 467-470
 - eddy current 469-470
 - flat 387
 - ultrasonic 467-468
 - Thickness gauges 97, 179, 185-202
(see External measuring instruments)
 - Thread gauges 377-381, 384
 - thread cutting tool gauges 384
 - thread jaw gauges 381
 - thread plug and ring gauges 377-381
 - Thread measuring wires (three-wire method) 125
 - Thread tables 133, 387
 - Three-point internal micrometers 141-158
 - absolute 157
 - digital 142, 144-146, 151-152, 154-157
 - Etalon 149
 - IP54 144-146, 151-152, 154-155
 - IP65 156
 - Mitutoyo 156-157
 - Roch 153
 - TESA 147-148, 150-152, 154-155
 - Three-point internal micrometers DIN 863 140
 - Timerbox 487
 - Toggle clamps for long gauge blocks 359
 - Tolerator tolerance table 133, 387
 - Tool presetters 245
 - Toolmakers' sets 311
 - Toolmakers' squares 310
 - Torquemeters 476-477
 - digital 477
 - Touch probe measuring machines DeMeet 490-496
 - Touch sensors 30, 243-244
 - TP20 probe system 514
 - Trammels 437
 - Tri-o-Bor three-point internal micrometers 150
 - Tube wall thickness gauges
 - calipers 51, 55
 - external measuring instruments ... 185, 189-192, 196
 - micrometers 111-113, 128-129
 - TWIN-Cal calipers 40
 - Twist drill grinding gauges 382
- U**
- Ultrasonic thickness gauges 467-468
 - Unimaster internal and external
measuring instrument 202
 - Unimeter universal measuring instruments 199-200
 - Universal measuring instruments 199-201
 - Universal micrometers 112, 115, 128-129
 - Universal setting instruments 441
 - Universal thickness gauges 196
 - USB Input Tool Direct 487
 - U-WAVE Wireless Communication System 487
- V**
- V-blocks 289-292
 - adjustable 291
 - granite 292
 - magnetic 290, 292
 - Vibration testers digital 480
 - Video measuring instruments DeMeet 490-495
 - Video microscopes 410-411, 413-415
 - Vises 293-295
- W**
- Wedges 382
 - Welding seam gauges and calipers 386
 - Wire and ball micrometers 126
 - Workshop calipers 56-60, 69-71
- X**
- X-blocks 289
- Z**
- Z-axis setting gauges 244



Schut Geometrical Metrology

Schut Geometrische Meettechniek bv
Duinkerkenstraat 21, 9723 BN Groningen, The Netherlands
P.O. Box 5225, 9700 GE Groningen
Chamber of Commerce, Groningen, The Netherlands, No. 02018313
VAT No. NL001360267B01



Terms of sales and delivery**General**

These terms of sales and delivery are exclusively valid with rejection of all other terms of delivery, which may be declared valid, specifically the terms of the buyer, for all our deliveries, unless a written other agreement has been made.

Prices

The prices in this catalogue are in EUR and excl. VAT and do not include the costs of assembly, installation, instruction, transport package, shipment, etc. if applicable. Delivery ex. works Groningen, The Netherlands.

Payment

Payment of our invoice should be made to our bank account without deduction of any discount. Any deduction will be charged. We remain the right for invoicing partial deliveries. We reserve the right to charge interest on the delayed payments. In case of payment delay we reserve the right to postpone new deliveries and services.

The prices in this catalog can change on any moment. For current prices refer to our online catalog on www.Schut.com.

Ownership Reservation

The delivered goods shall remain our legal property until full payment of the related invoice(s) is fulfilled.

Delivery Time

The delivery time we mention in an offer, is the time counting from the day we receive the order, interim sales preserved. We do our utmost to meet the confirmed delivery time. This is deemed to be an estimate and a prolongation of the delivery time can not give rise to contractual obligations or any claims. The order can not be withdrawn due to prolongation of the delivery.

Warranty

Our warranty is at all times explicitly limited to the repair or replacement of the defective goods or credit of the amount invoiced to the buyer for such goods. Any related travelling or shipping costs are charged to the buyer. Any claim for compensation of consequential or any indirect loss or damage shall not be taken into consideration. The quality-warranty provided by the producer of the catalog-items is applicable. All defects and damage, direct or indirect, caused by the buyer or third-party due to unprofessional, wrongly or careless handling of the goods are excluded from warranty and will not be refunded.

Return Shipment

A return shipment can only be accepted, if it has been agreed upon on beforehand. Return shipments must carry a return-authorization-number and a written problem-description. 10% of the sale price of the products (with a minimum of EUR 25.- per article) will not be credited, in the case the product is taken back by us. The carriage and customs have to be paid and taken care of by the buyer. Goods especially made or ordered for the customer and flawless goods can never be returned. No consignment on approval will be made.

Repairs

Regarding the fulfillment of repair-order applications and repairs our conditions for return shipments have to be fulfilled. Besides these, we reserve the right to charge the costs for repair-order applications, consisting of investigation costs and transport costs, even when repair is not possible or not profitable.

Complaints

The shipment should be checked on completeness, correctness and on defects. Complaints about delivered goods must be made in writing latest within eight (8) days after receipt of the goods, otherwise the goods are considered as accepted. Damages caused by transport are to be reported to the shipper and to us in writing, immediately after receipt of the goods.

Additional Provisions

The terms of sales and delivery are registered at the Chamber of Commerce of Groningen, The Netherlands. All disputes of any kind, originated in any geographical location, are to be settled by the court of law in Groningen, The Netherlands. The Dutch law is applicable.

Much attention has been given to the presentation of correct information. The pictures and illustrations have also been attended to with great care. Nevertheless, it is almost inevitable that differences with the delivered product may occur. Continuous development and advancing insights may also be reasons for any possible difference.

All prices in this catalog are exclusive of VAT Prices and specifications are subject to change.

**© Schut Geometrische Meettechniek bv, NL-9700 GE Groningen
All rights for duplication and reproduction of this catalog are reserved.**

Notes

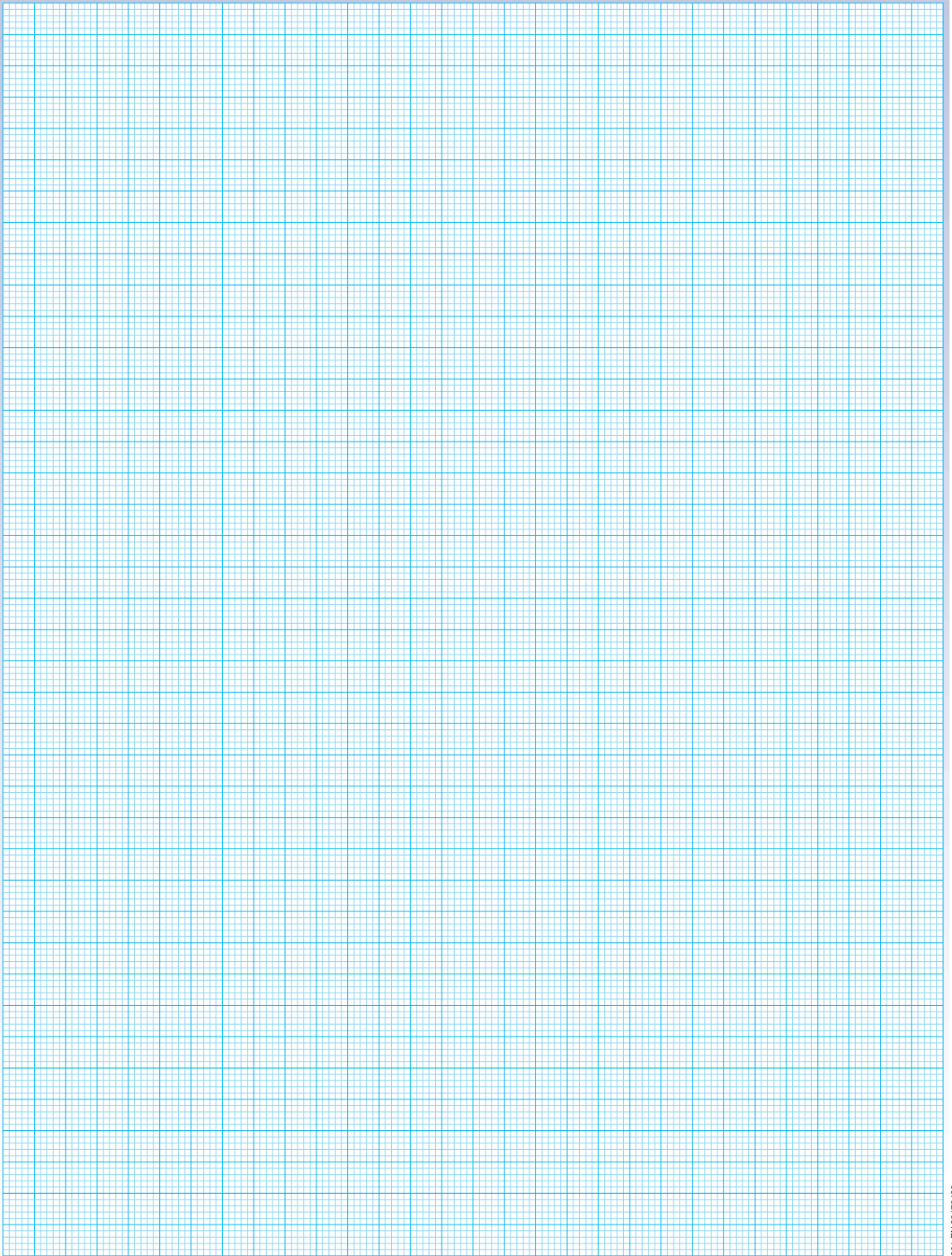

C99.301-EN-20170420

Notes

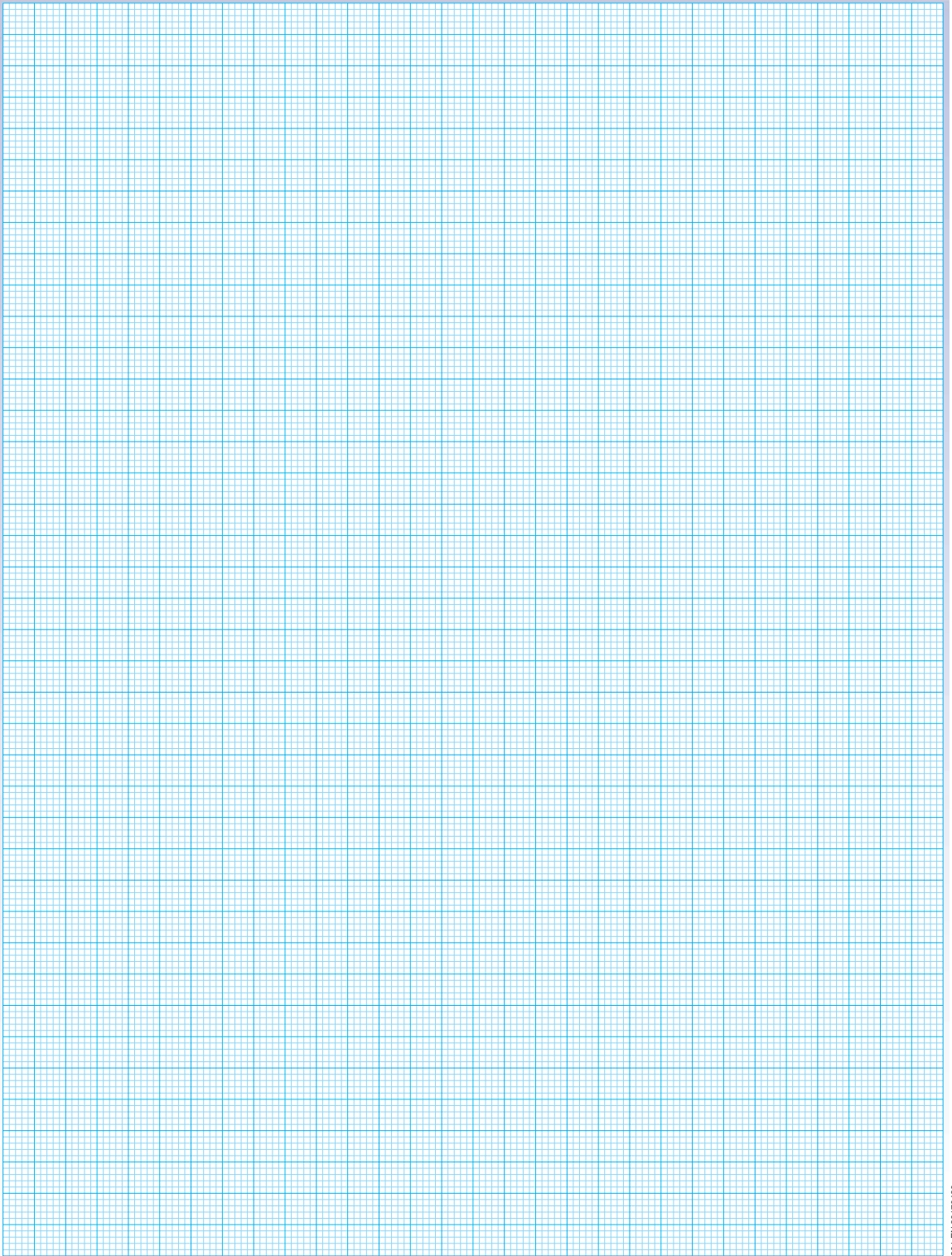

C99.301-EN-20170420

Notes

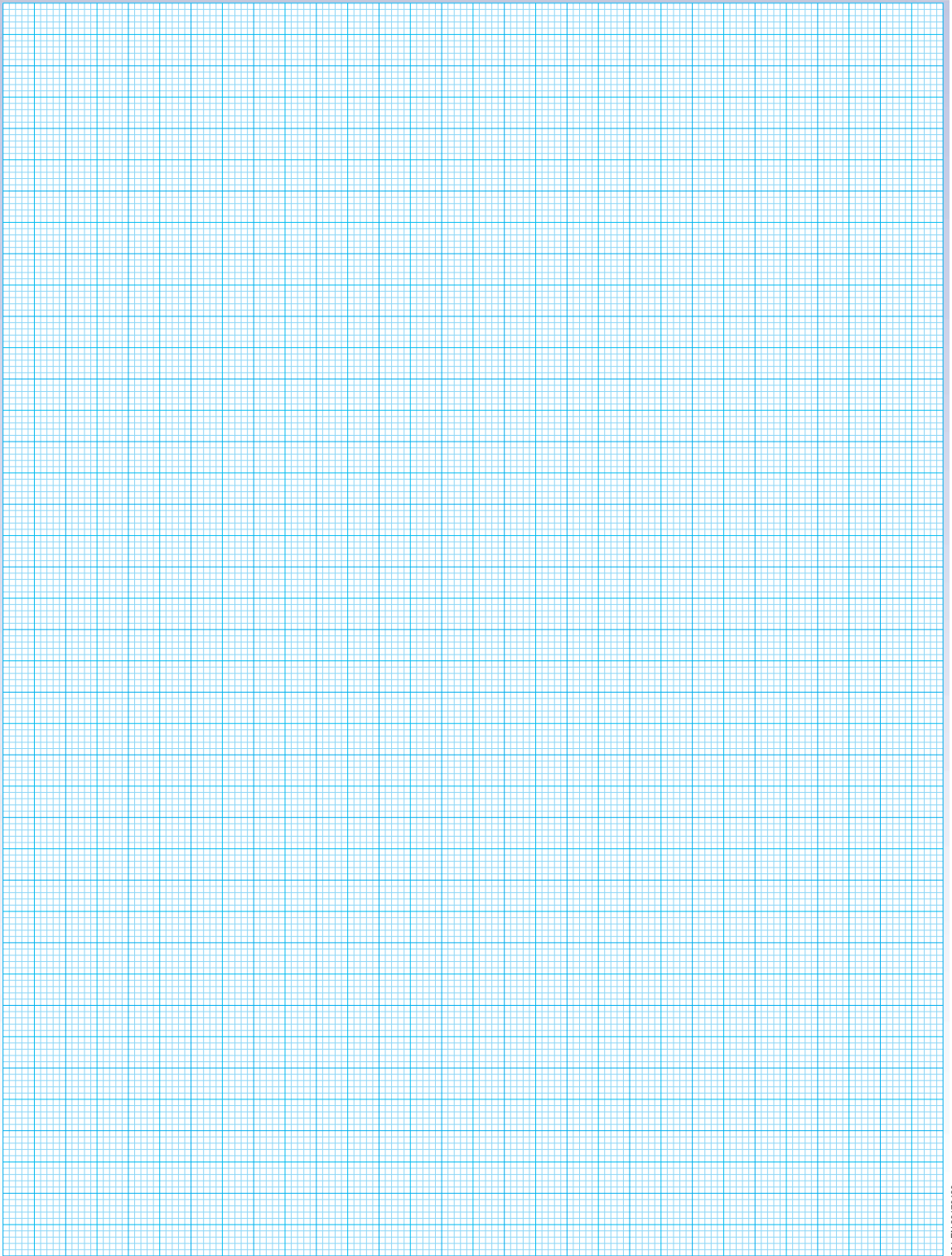

Notes

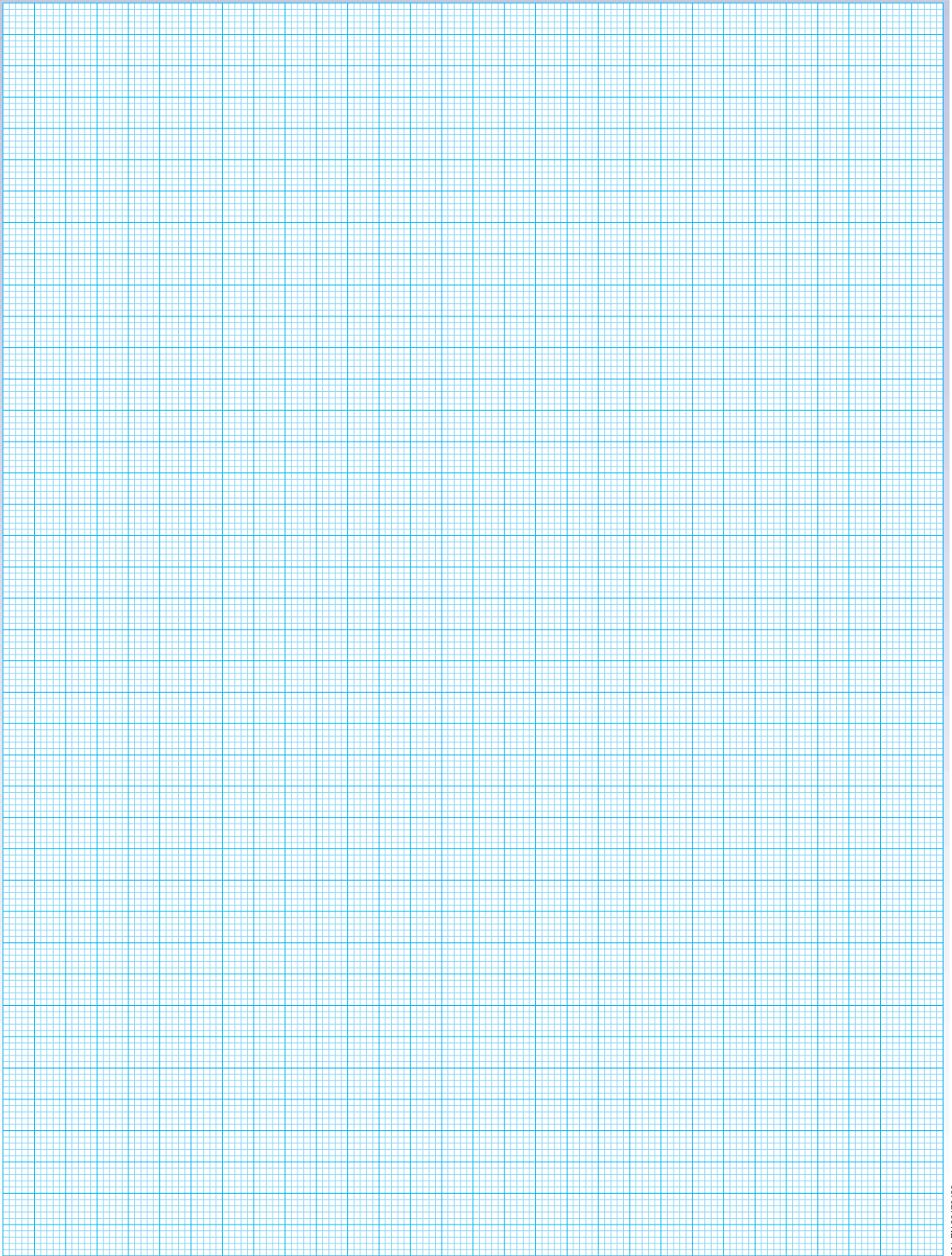

C99.301.EN.20170420

Notes

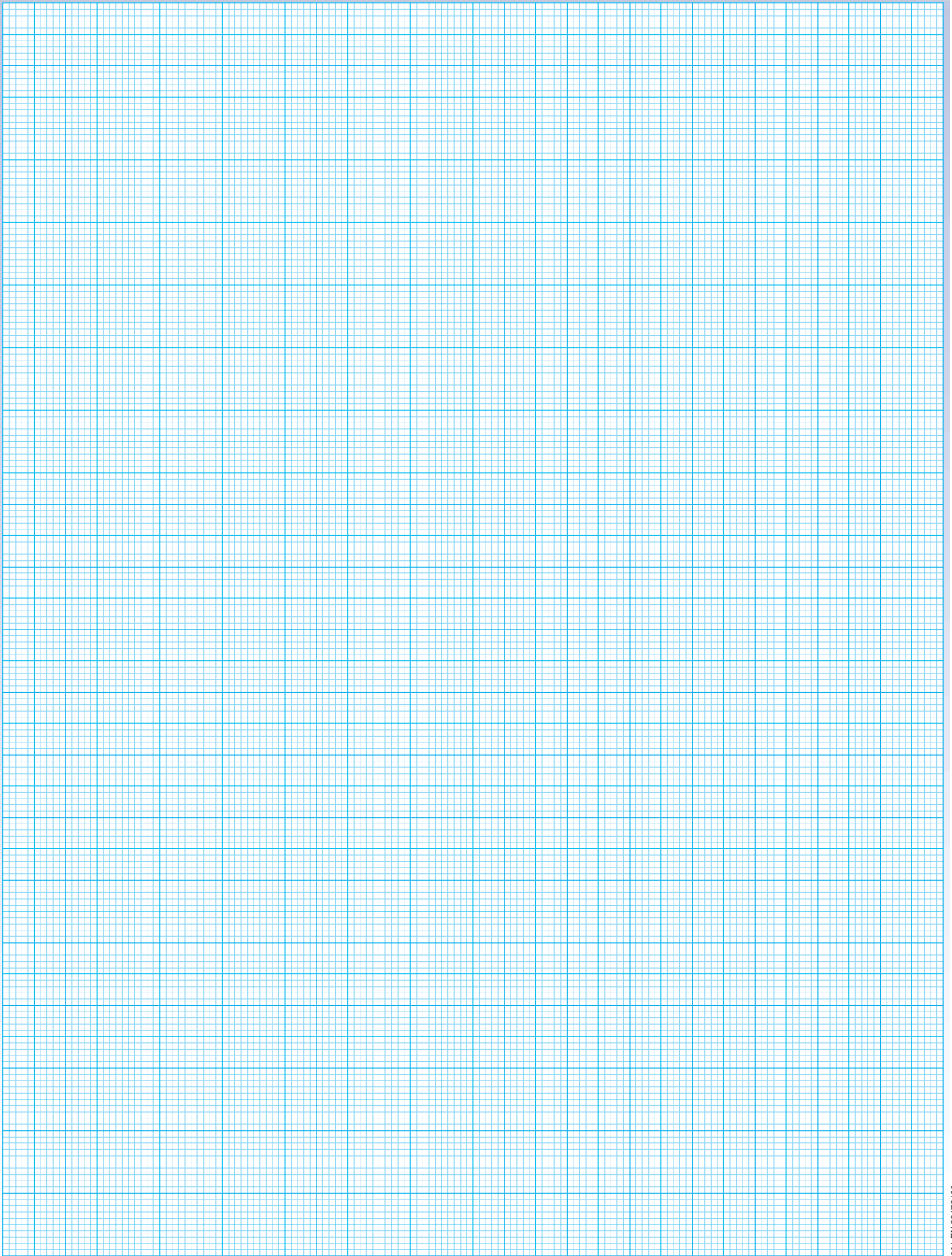

Notes

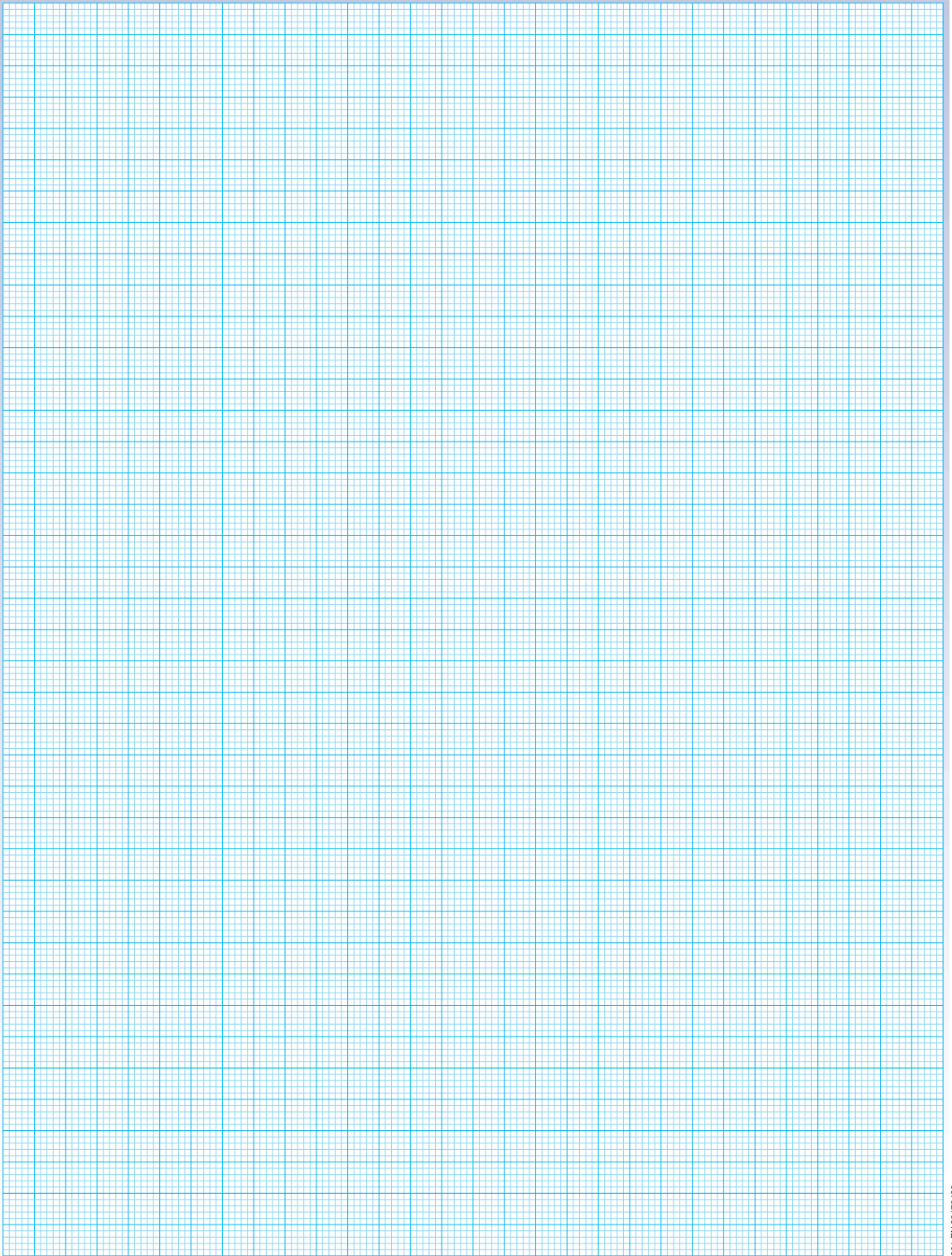

C99.301.EN.20170420

Notes

