

PHE 1020TGRID

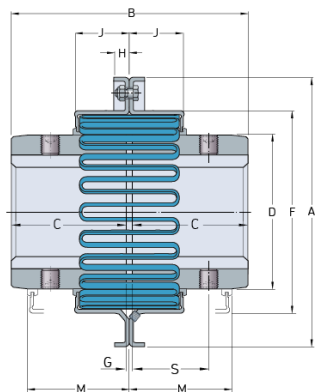

Size	1020
Nominal torque (Nm)	52
Max speed (r/min)	6000
Min. bore (mm)	12
Max. bore (mm)	30
Weight (kg)	0.08