

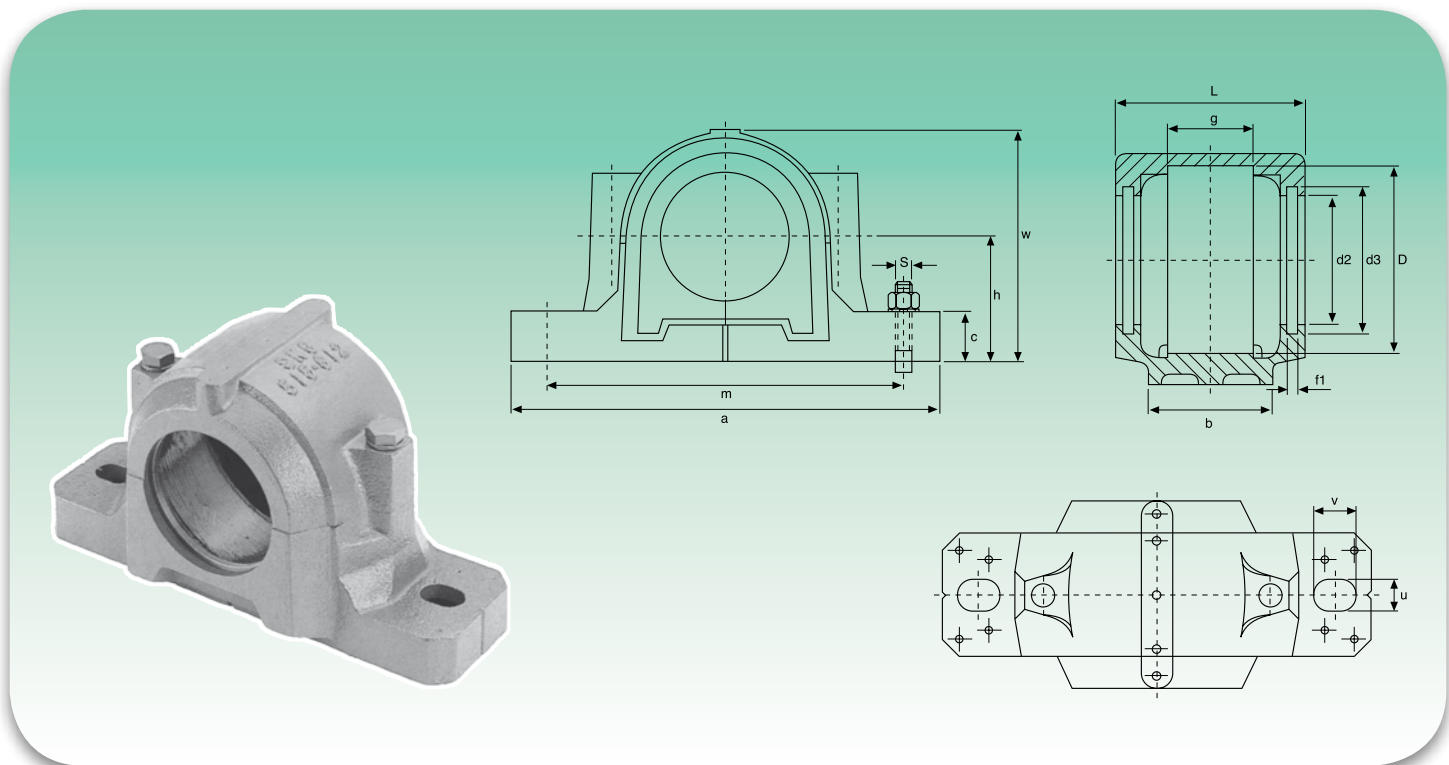

**GETEILTE STEHLAGERGEHÄUSE - КОРПУС ОПОРНОГО ПОДШИПНИКА ИЗ ДВУХ ЧАСТЕЙ**  
**SNG 500**



Typ Тип	Wellendurchmesser Диаметр вала			Abmessungen - Размеры													Bef.Bolz. Креп. винт	
				D H8	a	b	c	g H12	h js11	L	w	m	U	V	d2 H12	d3 H12	f1	S
	mm	Zoll - дюйм		mm/Zoll - мм/дюйм														
SNG 505	20	¾		52	165	46	19	25	40	67	71	130	13	20	31,5	39,5	5	M10
SNG 506-605	25	15/16	1	62	185	52	22	32	50	77	87	150	13	22	36,5	44,5	5	M10
SNG 507-606	30	1 1/8	13/16	72	185	52	22	34	50	82	92	150	15	20	46,5	54,5	5	M12
SNG 508-607	35	15/16	13/8	80	205	60	25	39	60	85	106	170	15	20	51,5	59,5	5	M12
SNG 509	40	1 ½	19/16	85	205	60	25	30	60	85	109	170	15	20	56,5	64,5	5	M12
SNG 510-608	45	1 11/16	1 ¾	90	205	60	25	41	60	90	112	170	15	20	62	70,5	5	M12
SNG 511-609	50	1 15/16	2	100	255	70	28	44	70	95	127	210	18	23	67	75,5	5	M16
SNG 512-610	55	2 1/8	23/16	110	255	70	30	48	70	105	133	210	18	23	72	80,5	5	M16
SNG 513-611	60	2 ¼	25/16	120	275	80	30	51	80	110	148	230	18	24	77	85,5	5	M16
SNG 515-612	65	27/16	2 ½	130	280	80	30	56	80	115	154	230	18	26	87	95,5	5	M16
SNG 516-613	70	2 11/16	2 ¾	140	315	90	32	58	95	120	175	260	22	29	92,5	101	5	M20
SNG 517	75	2 15/16	3	150	320	90	32	61	95	125	181	260	22	30	97,5	106	5	M20
SNG 518-615	80	33/16	3 ¼	160	345	100	35	65	100	140	192	290	22	27	102,5	111	5	M20
SNG 519-616	85	35/16	33/8	170	345	100	35	68	112	145	209	290	22	27	131	141	6	M20
SNG 520-617	90	37/16	3 ½	180	380	110	40	70	112	160	215	320	26	32	137,5	147,5	6	M24
SNG 522-619	100	3 15/16	4	200	410	120	45	80	125	175	239	350	26	32	147,5	157,5	6	M24
SNG 524-620	110	43/16	4 ¼	215	410	120	45	86	140	185	271	350	26	32	157,5	167,5	6	M24
SNG 526	115	47/16	4 ½	230	445	130	50	90	150	190	290	380	28	35	167,5	177,5	6	M24
SNG 528	125	4 15/16	5	250	500	150	50	98	150	205	302	420	35	42	177,5	187,5	6	M30
SNG 530	135	53/16	5 ¼	270	530	160	60	106	160	220	323	450	35	42	192,5	202,5	6	M30
SNG 532	140	57/16	5 ½	290	550	160	60	114	170	235	344	470	35	42	202,5	212,5	6	M30

**GETEILTE STEHLAGERGEHÄUSE - КОРПУС ОПОРНОГО ПОДШИПНИКА ИЗ ДВУХ ЧАСТЕЙ**



**SNG 500**

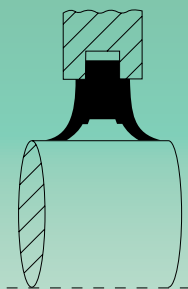

**Polyurethandichtung "TSNG" für: SNG-SNU**  
Уплотнение из полиуретана "TSNG" для: SNG-SNU

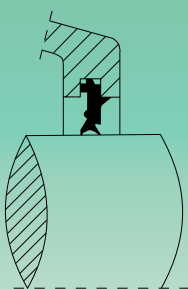

**Gummidichtung "TSNU" für: SNG-SNU**  
Уплотнение из каучука "TSNU" для: SNG-SNU

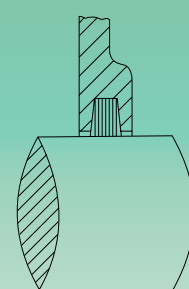

**Filzdichtung "TSNC" für: SNG-SNU**  
Фетровое уплотнение "TSNC" для: SNG-SNU

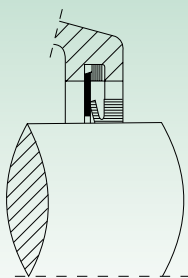

**V-Ring-Dichtung "TSNA" für: SNG-SNU**  
Манжета v-образного сечения "TSNA" для: SNG-SNU

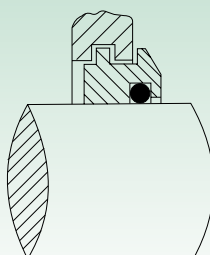

**Labyrinthdichtung "TSNS" für: SNG-SNU**  
Лабиринтное уплотнение "TSNS" для: SNG-SNU

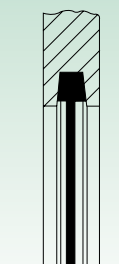

**Verschlussdeckel "A" für: SNG-SNU-SN**  
Торцевая крышка "A" для: SNG-SNU-SN

Pendel- kugellager (kegelige Bohrung) <i>Подшипник шариковый автоматического выравнивания (коническое отверстие)</i>	Pendel- rollenlager (kegelige Bohrung) <i>Подшипник роликовый автоматического выравнивания (коническое отверстие)</i>	Spannhülse (metrisch) <i>Закрепительная штука (метрическая)</i>	Zentrierring <i>Стопорное кольцо</i>		Gewicht <i>Вес</i>	"TSNG"	"TSNU"	"TSNC"	"TSNA"	"TSNS"	"A"	Typ <i>Тип</i>
			Typ <i>Тип</i>	Menge <i>К-во</i>		kg	Polyurethan- dichtung <i>Уплотнение из полиуретана</i>	Gummidichtung <i>Резиновая прокладка</i>	Filz- dichtung <i>Уплотнение из фетра</i>	V-Ring - Dichtung <i>Уплотнение V-Ring</i>		
1205 K	-	H 205	SR 52x5	2	2,1	TSNG 505	TSNU 505	TSNC 505	TSNA 505	TSNS 505	A 505	<b>SNG 505</b>
1206 K	-	H 205	SR 62x5	2	2,4	TSNG 506	TSNU 506	TSNC 506	TSNA 506	TSNS 506	A 506-605	<b>SNG 506-605</b>
1207 K	-	H 207	SR 72x8,5	2	2,2	TSNG 507	TSNU 507	TSNC 507	TSNA 507	TSNS 507	A 507-606	<b>SNG 507-606</b>
2207 K	22207 K	H 307	SR 72x5,5	2		TSNG 508	TSNU 508	TSNC 508	TSNA 508	TSNS 508	A 508-607	<b>SNG 508-607</b>
1208 K	-	H 208	SR 80x10,5	2	2,8	TSNG 509	TSNU 509	TSNC 509	TSNA 509	TSNS 509	A 509	<b>SNG 509</b>
2208 K	22208 K	H 308	SR 80x8	2		TSNG 510	TSNU 510	TSNC 510	TSNA 510	TSNS 510	A 510-608	<b>SNG 510-608</b>
1209 K	-	H 209	SR 85x5,5	2	3,0	TSNG 511	TSNU 511	TSNC 511	TSNA 511	TSNS 511	A 511-609	<b>SNG 511-609</b>
2209 K	22209 K	H 309	SR 85x7	1		TSNG 512	TSNU 512	TSNC 512	TSNA 512	TSNS 512	A 512-610	<b>SNG 512-610</b>
1210 K	-	H 210	SR 90x10,5	2	3,1	TSNG 513	TSNU 513	TSNC 513	TSNA 513	TSNS 513	A 513-611	<b>SNG 513-611</b>
2210 K	22210 K	H 310	SR 90x9	2		TSNG 514	TSNU 514	TSNC 514	TSNA 514	TSNS 514	A 514-612	<b>SNG 514-612</b>
1211 K	-	H 211	SR 100x11,5	2	4,5	TSNG 515	TSNU 515	TSNC 515	TSNA 515	TSNS 515	A 515-612	<b>SNG 515-612</b>
2211 K	22211 K	H 311	SR 100x9,5	2		TSNG 516	TSNU 516	TSNC 516	TSNA 516	TSNS 516	A 516-613	<b>SNG 516-613</b>
1212 K	-	H 212	SR 110x13	2	5,0	TSNG 517	TSNU 517	TSNC 517	TSNA 517	TSNS 517	A 517	<b>SNG 517</b>
2212 K	22212 K	H 312	SR 110x10	2		TSNG 518	TSNU 518	TSNC 518	TSNA 518	TSNS 518	A 518-615	<b>SNG 518-615</b>
1213 K	-	H 213	SR 120x14	2	6,1	TSNG 519	TSNU 519	TSNC 519	TSNA 519	TSNS 519	A 519-616	<b>SNG 519-616</b>
2213 K	22213 K	H 313	SR 120x10	2		TSNG 520	TSNU 520	TSNC 520	TSNA 520	TSNS 520	A 520-617	<b>SNG 520-617</b>
1215 K	-	H 215	SR 130x15,5	2	6,5	TSNG 521	TSNU 521	TSNC 521	TSNA 521	TSNS 521	A 521-619	<b>SNG 521-619</b>
2215 K	22215 K	H 315	SR 130x12,5	2		TSNG 522	TSNU 522	TSNC 522	TSNA 522	TSNS 522	A 522-619	<b>SNG 522-619</b>
1216 K	-	H 216	SR 140x16	2	9,0	TSNG 523	TSNU 523	TSNC 523	TSNA 523	TSNS 523	A 523-620	<b>SNG 523-620</b>
2216 K	22216 K	H 316	SR 140x12,5	2		TSNG 524	TSNU 524	TSNC 524	TSNA 524	TSNS 524	A 524-620	<b>SNG 524-620</b>
1217 K	-	H 217	SR 150x16,5	2	10,2	TSNG 525	TSNU 525	TSNC 525	TSNA 525	TSNS 525	A 525	<b>SNG 525</b>
2217 K	22217 K	H 317	SR 150x12,5	2		TSNG 526	TSNU 526	TSNC 526	TSNA 526	TSNS 526	A 526	<b>SNG 526</b>
1218 K	-	H 218	SR 160x17,5	2	12,4	TSNG 527	TSNU 527	TSNC 527	TSNA 527	TSNS 527	A 527	<b>SNG 527</b>
2218 K	22218 K	H 318	SR 160x12,5	2		TSNG 528	TSNU 528	TSNC 528	TSNA 528	TSNS 528	A 528	<b>SNG 528</b>
2218 K	23218 K	H 2318	SR 160x12,5	1	13,5	TSNG 529	TSNU 529	TSNC 529	TSNA 529	TSNS 529	A 529-616	<b>SNG 529-616</b>
1219 K	-	H 219	SR 170x18	2		TSNG 530	TSNU 530	TSNC 530	TSNA 530	TSNS 530	A 530	<b>SNG 530</b>
2219 K	22219 K	H 319	SR 170x12,5	2	17,5	TSNG 531	TSNU 531	TSNC 531	TSNA 531	TSNS 531	A 531-617	<b>SNG 531-617</b>
2220 K	22220 K	H 320	SR 180x12	2		TSNG 532	TSNU 532	TSNC 532	TSNA 532	TSNS 532	A 532	<b>SNG 532</b>
-	23220 K	H 2320	SR 180x9,7	1	20,5	TSNG 533	TSNU 533	TSNC 533	TSNA 533	TSNS 533	A 533	<b>SNG 533</b>
2222 K	22222 K	H 322	SR 200x13,5	2		TSNG 534	TSNU 534	TSNC 534	TSNA 534	TSNS 534	A 534-620	<b>SNG 534-620</b>
-	23222 K	H 2322	SR 200x10	1	25,5	TSNG 535	TSNU 535	TSNC 535	TSNA 535	TSNS 535	A 535	<b>SNG 535</b>
-	22224 K	H 3124	SR 215x14	2		TSNG 536	TSNU 536	TSNC 536	TSNA 536	TSNS 536	A 536	<b>SNG 536</b>
-	23224 K	H 2324	SR 215x10	1	33,0	TSNG 537	TSNU 537	TSNC 537	TSNA 537	TSNS 537	A 537	<b>SNG 537</b>
-	22226 K	H 3126	SR 230x13	2		TSNG 538	TSNU 538	TSNC 538	TSNA 538	TSNS 538	A 538	<b>SNG 538</b>
-	23226 K	H 2326	SR 230x10	1	42,0	TSNG 539	TSNU 539	TSNC 539	TSNA 539	TSNS 539	A 539	<b>SNG 539</b>
-	22228 K	H 3128	SR 250x15	2		TSNG 540	TSNU 540	TSNC 540	TSNA 540	TSNS 540	A 540	<b>SNG 540</b>
-	23228 K	H 2328	SR 250x10	1	53,0	TSNG 541	TSNU 541	TSNC 541	TSNA 541	TSNS 541	A 541	<b>SNG 541</b>
-	22230 K	H 3130	SR 270x16,5	2		TSNG 542	TSNU 542	TSNC 542	TSNA 542	TSNS 542	A 542	<b>SNG 542</b>
-	23230 K	H 2330	SR 270x10	1	55,0	TSNG 543	TSNU 543	TSNC 543	TSNA 543	TSNS 543	A 543	<b>SNG 543</b>
-	22232 K	H 3132	SR 290x17	2		TSNG 544	TSNU 544	TSNC 544	TSNA 544	TSNS 544	A 544	<b>SNG 544</b>
-	23232 K	H 2332	SR 290x10	1								