

SKF



SKF TMMD 100

Instructions for use
Mode d'emploi
Bedienungsanleitung
Instrucciones de uso
Manuale d'istruzioni
Bruksanvisning

Gebruiksaanwijzing
Instrucções de utilização
Brugervejledning
Käyttöohje
Οδηγίες χρήσης

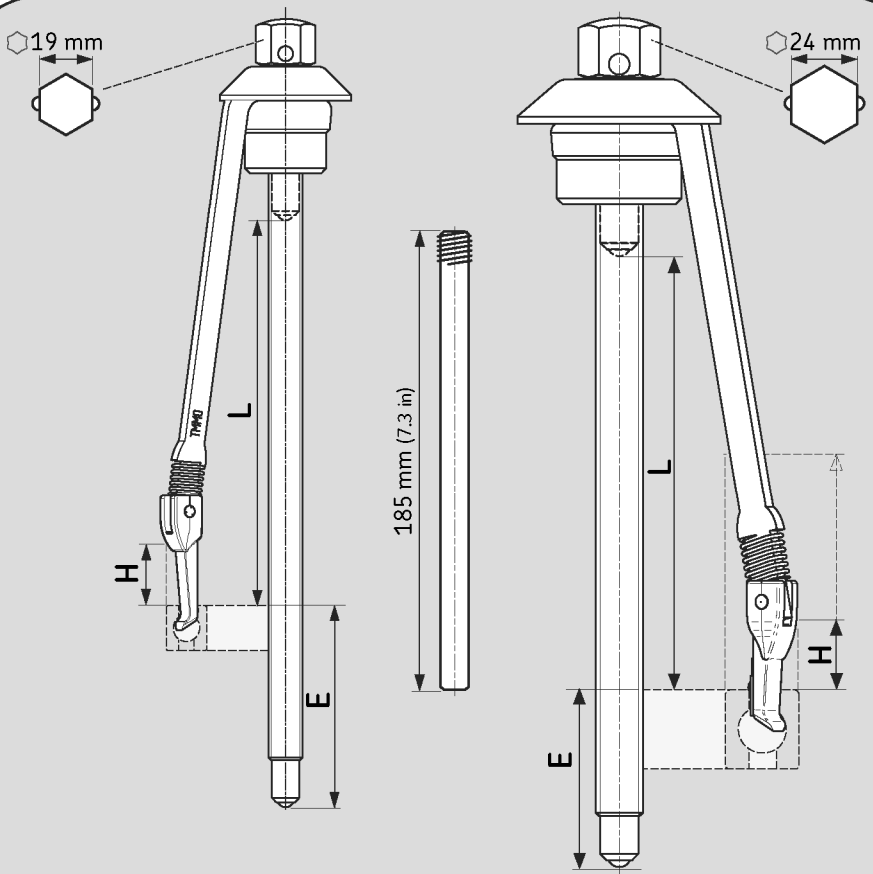

	L		H		E	
	mm	in	mm	in	mm	in
TMMD 100-A1	135	5.3	16	0.6	79	3.1
TMMD 100-A2	135	5.3	16	0.6	79	3.1
TMMD 100-A3	137	5.4	23	0.9	77	3.0

	L		H		E	
	mm	in	mm	in	mm	in
TMMD 100-A4	162	6.4	26	1.0	52	2.0
TMMD 100-A5	167	6.6	>52	>2.0	49	1.9
TMMD 100-A6	170	6.7	>100	>3.9	49	1.9

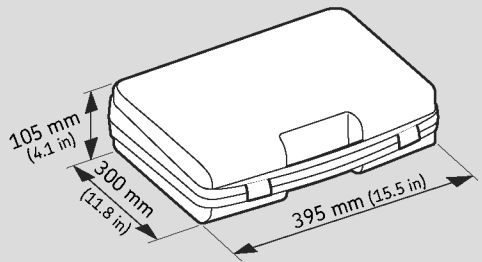



TMMD 100
MP 5265



TMBA G11W

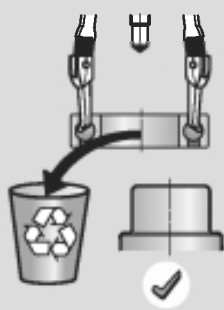
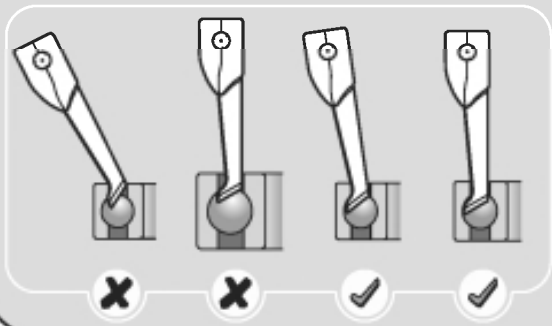
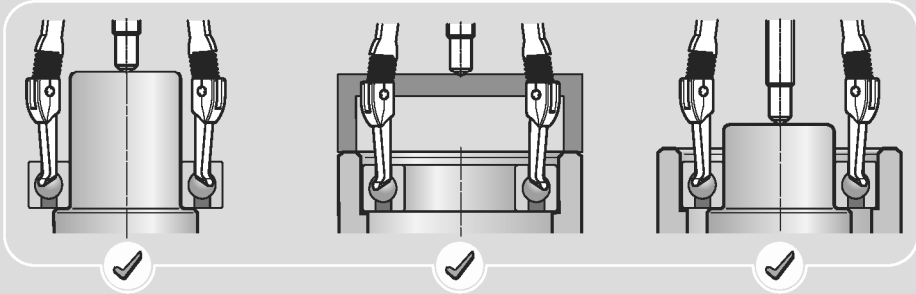
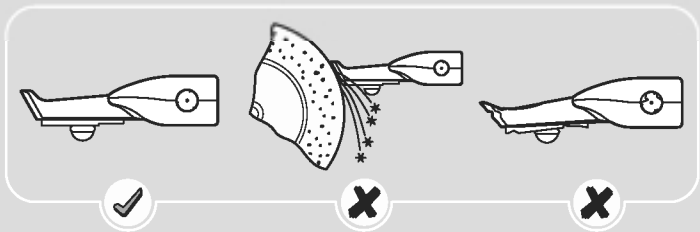
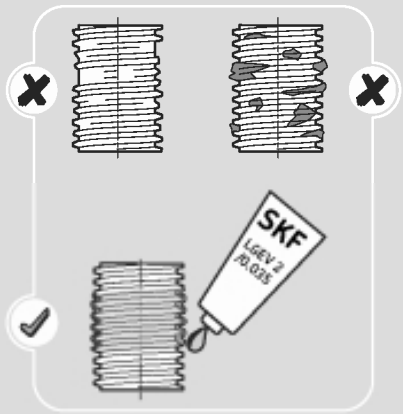

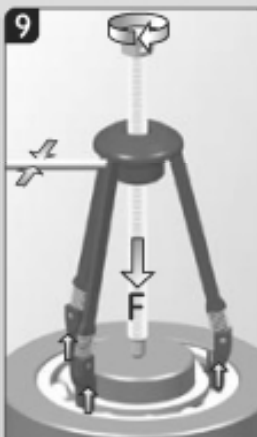
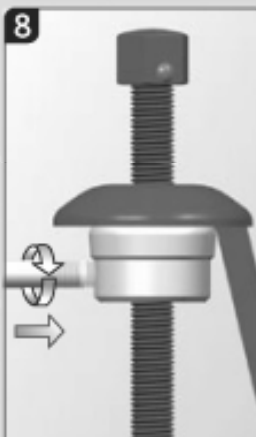
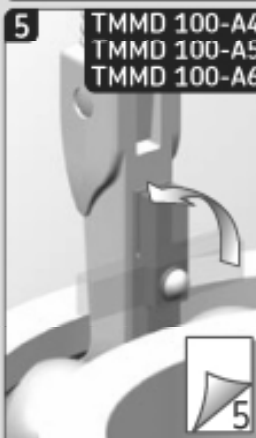
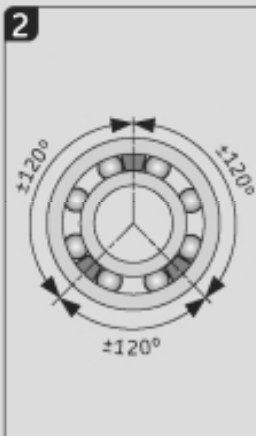
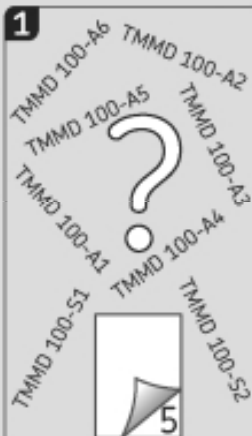

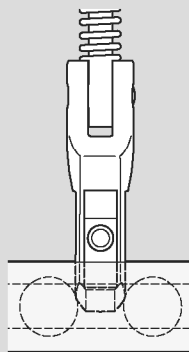
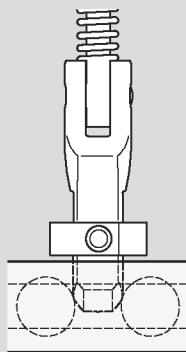
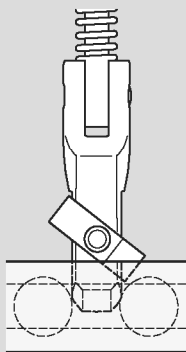
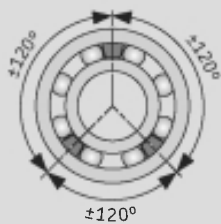
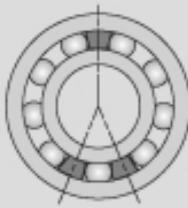
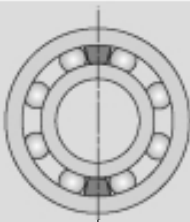
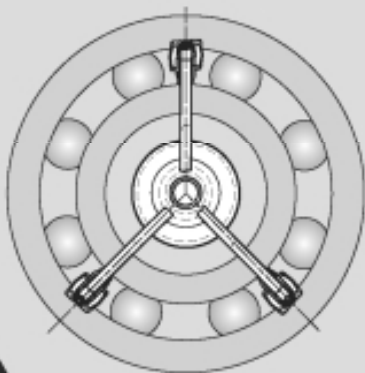
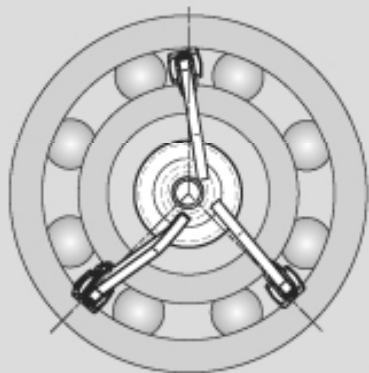

TMMD 100-A1

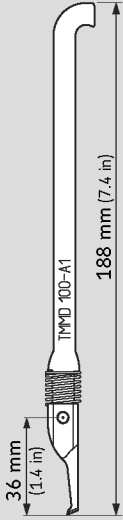

TMMD 100-A2

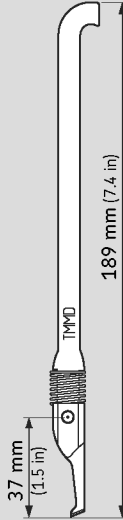

TMMD 100-A3

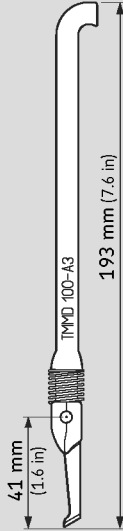

TMMD 100-S1

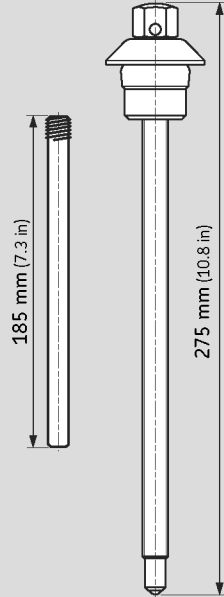

TMMD 100-A4

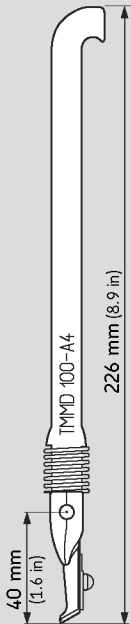

TMMD 100-A5

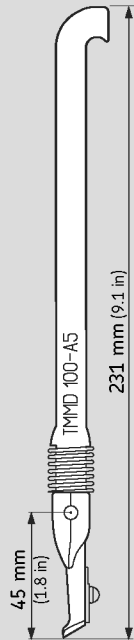

TMMD 100-A6

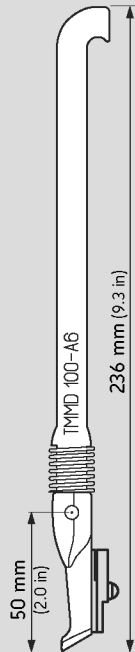

TMMD 100-S2

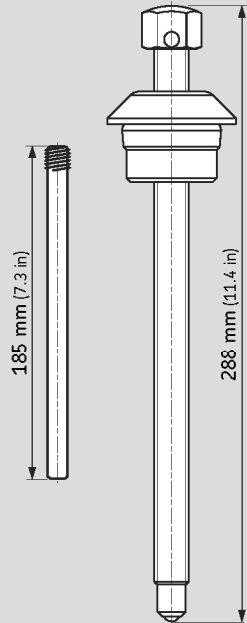

In line with our policy of continuous development of our products we reserve the right to alter any part of the above specification without prior notice. Although care has been taken to ensure the accuracy of this publication, SKF does not assume any liability for errors or omissions.

I overensstemmelse med vor politik for kontinuerlig udvikling af vore produkter forbeholder vi os ret til at ændre på hvilken som helst af de i brochuren nævnte specifikationer, uden at meddele dette i forvejen. Desuden tages der forbehold for eventuelle trykfejl.

Gemäß unserer Firmenpolitik der ständigen Weiterentwicklung unserer Produkte behalten wir uns Änderungen der obigen Daten ohne Vorankündigung vor.

En línea con nuestra política de constante desarrollo de nuestros productos, nos reservamos el derecho a modificar cualquier parte de las especificaciones sin previa notificación.

Conformément à notre politique de développement continu de nos produits, nous nous réservons le droit de modifier, sans préavis, tout ou partie des spécifications.

In linea con la nostra politica a di sviluppo continuo dei prodotti ci riserviamo il diritto di apportare modifiche senza preavviso a qualsiasi parte della presente documentazione.

In verband met onze politiek van continue ontwikkeling van onze producten, behouden wij ons het recht voor om de specificaties van de vermelde onderdelen te wijzigen zonder nota vooraf.

Em linha com a nossa política de desenvolvimento contínuo dos nossos produtos, reservamo-nos o direito de alterar este catálogo sem aviso prévio.

Tavoitteenamme on tuotteidemme jatkuva kehittyä. Pidätämme siksi oikeuden etukäteen ilmoittamatta muuttaa yllä olevia erittelyjä.

I linje med vår policy för kontinuerlig utveckling av våra produkter förbehåller vi oss rätten att ändra ovanstående specifikationer utan att meddela i förväg.

Σύμφωνα με την πολιτική της συνεχούς ανάπτυξης των προϊόντων μας, διατηρούμε το δικαίωμα να αλλάξουμε οποιοδήποτε μέρος των παραπάνω χαρακτηριστικών χωρίς προειδοποίηση.

SKF Maintenance Products

© Copyright SKF 2006/03

www.mapro.skf.com
www.skf.com/mount

MP5265

