

# PHE 1190TGRID

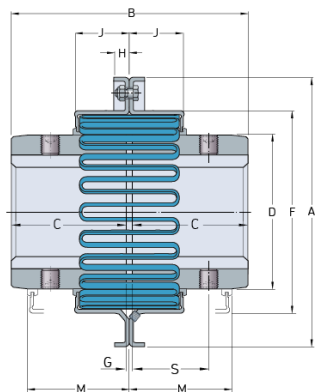

Size	1190
Nominal torque (Nm)	137000
Max speed (r/min)	1300
Min. bore (mm)	152
Max. bore (mm)	339
Weight (kg)	21.6