

PHE 1150TGHCOVER

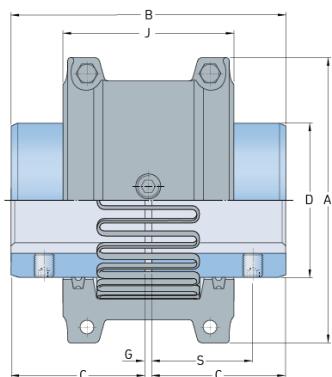

Size	1150
Nominal torque (Nm)	39800
Max speed (r/min)	1500
Min. bore (mm)	108
Max. bore (mm)	203
Weight (kg)	24.7