

PHE 1110TGHCOVER

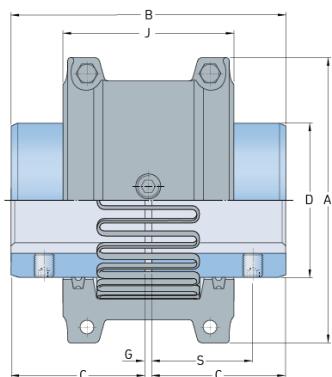

Size	1110
Nominal torque (Nm)	9320
Max speed (r/min)	2250
Min. bore (mm)	41
Max. bore (mm)	117
Weight (kg)	5.4