

PHE 1050TGHCOVER

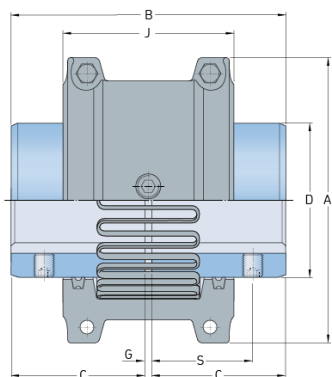

Size	1050
Nominal torque (Nm)	435
Max speed (r/min)	4500
Min. bore (mm)	12
Max. bore (mm)	50
Weight (kg)	0.9