

PHE 1030TGRID

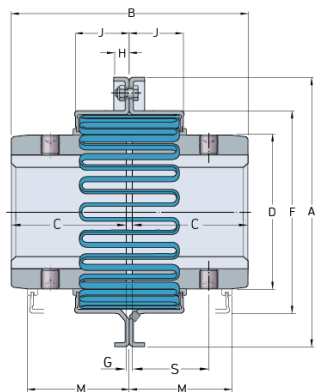

Size	1030
Nominal torque (Nm)	149
Max speed (r/min)	6000
Min. bore (mm)	12
Max. bore (mm)	36
Weight (kg)	0.08